



HAL
open science

Prediction of Transmission Loss using an improved SEA Method

Rainer Stelzer, Nicolas Totaro, Goran Pavic, Jean-Louis Guyader

► **To cite this version:**

Rainer Stelzer, Nicolas Totaro, Goran Pavic, Jean-Louis Guyader. Prediction of Transmission Loss using an improved SEA Method. 10ème Congrès Français d'Acoustique, Apr 2010, Lyon, France. hal-00539656

HAL Id: hal-00539656

<https://hal.science/hal-00539656>

Submitted on 24 Nov 2010

HAL is a multi-disciplinary open access archive for the deposit and dissemination of scientific research documents, whether they are published or not. The documents may come from teaching and research institutions in France or abroad, or from public or private research centers.

L'archive ouverte pluridisciplinaire **HAL**, est destinée au dépôt et à la diffusion de documents scientifiques de niveau recherche, publiés ou non, émanant des établissements d'enseignement et de recherche français ou étrangers, des laboratoires publics ou privés.

10ème Congrès Français d'Acoustique

Lyon, 12-16 Avril 2010

Prediction of Transmission Loss using an improved SEA Method

Rainer Stelzer¹, Nicolas Totaro¹, Goran Pavic¹, Jean-Louis Guyader¹

¹ INSA Lyon Laboratoire Vibrations et Acoustique, 25 Bis Avenue Jean Capelle Bâtiment St. Exupéry, 69621 Villeurbanne Cedex

rainer.stelzer@insa-lyon.fr

Statistical energy analysis (SEA) is a well-known method, which can be also used for prediction of transmission loss. The difficulty in this method is to estimate the coupling loss factors, which are needed to calculate the energy transfer between the subsystems. It has been shown in previous articles on examples for structure-to-structure and structure-to-cavity coupling, that the statistical modal energy distribution analysis (SmEdA) is a convenient method for calculating this coupling loss factors. This approach relies on a dual modal formulation to describe vibrations of coupled subsystems. However, the original SmEdA formulation takes into account only the resonant modes related to a frequency band. That is the reason for developing an improved approach on the basis of SmEdA in the framework of the Marie Curie project "MID-FREQUENCY". This improved method integrates the non resonant modes in the calculation. The application possibilities and the advantages of the new extended version of SmEdA are demonstrated on the example of transmission loss of a plate between two finite cavities. The principal advantages are that transmission loss can be predicted for non-diffuse sound fields and for different boundary conditions.

1 Introduction

The well-know transmission loss R is used to characterize the physical process of the transmission of acoustic power through a partition. It is defined with the transmission factor τ as follows [3]:

$$R = 10 \lg \left(\frac{1}{\tau} \right). \quad (1)$$

The transmission factor τ itself is the ratio of the power P_t transmitted through the partition and the incident power P_i .

$$\tau = \frac{P_t}{P_i} \quad (2)$$

The search for equations for τ depending on the parameters of the incident waves and the partition is a quite old field of research. The first one was the still very popular and often used so called "mass law"

$$R = 10 \lg \left[1 + \left(\frac{\omega m \cos \vartheta}{2\rho c} \right)^2 \right] \quad (3)$$

It describes the relation between the mass per area m , the angular frequency ω , the density ρ and the speed of sound c of the fluid, the angle of incidence ϑ and the transmission loss R . The basic acoustic equations for this law were formulated by Rayleigh and it was experimentally verified amongst others by Berger. The further development of this physical law was the formula of Cremer for thin infinite plates. He included the influence of the bending stiffness B on the transmission loss using the plate equation of Kirchhoff.

$$R_C = 10 \lg \left[1 + \left(\omega m - B\omega^3 \frac{\sin^4 \vartheta}{c^4} \right)^2 \left(\frac{\cos \vartheta}{2\rho c} \right)^2 \right] \quad (4)$$

In the following years till this day many other transmission loss models have been developed. For that purpose it exists more or less four different ways to handle the transmission problem. The first one is the wave approach, which was also used for the mass law and the formula of Cremer. Here it is tried to find exact analytical solutions of the wave equations and so to predict the transmission loss. Such approaches has been established for example for finite plates by Heckl [3] or for finite plate and finite cavities by Nilsson [10] and by Josse and Lamure [4]. But because of the involved assumptions and simplifications these are only useful for special cases and provide only rough estimates. The second way is to solve the transmission problem with a numerical method. This is in principle possible for all cases, even for complex geometries. Sakuma and Oshima [12], for example, developed a computational procedure for a finite plate with arbitrary elastic boundary conditions between two semi-infinite rooms with FEM. The third procedure is to use a variational approach. This is in principle a very general formulation of the transmission problem, but only applicable to simple geometries, like a rectangular plate. The variational approach was used for example by Gagliardini, Roland and Guyader [2] (finite systems) and by Woodcock [14] (finite plate) to develop transmission loss models. The fourth way is to calculate the transmission loss with the statistical energy analysis (SEA), like Lyon and DeJong [6] or Renji, Nair and Narayanan [11] have done it. SEA is a quite easy and fast method, because only a linear power balance equation system (one equation for each subsystem) must be solved. But the problem of this model is the description of the cavity-plate-cavity coupling. In addition SEA is generally only dedicated for high frequencies and diffuse sound fields. A description

of it is given in the following chapter. All in all there are still a lot of problems to calculate the transmission loss of more or less realistic cases. At the moment no calculation method exists, that can be used without restrictions for different geometries of cavities and plates, for different boundary conditions and for non diffuse sound fields. The calculation method for the transmission loss with the statistical modal energy distribution analysis (SmEdA), presented in this paper, can in principle handle these restrictions. SmEdA, which was developed by Maxit and Guyader [7], is a mixture of the other already described approaches. The basic equation system is the same as the one of SEA and it needs a functional basis, namely the eigenmodes of the subsystems, which can be calculated by one of the other methods. The latter represents a critical point of this prediction procedure, because the mode density increases with rising frequency and with rising size of the subsystems and so does the computation time.

2 Theory

2.1 Classical Statistical Energy Analysis

The statistical energy analysis is a well-known energy based method. The development of it started in the early 1960s with the works about coupled oscillators by Lyon and Smith [6]. The fundamental equation of this method is the power balance for each subsystem (for example an oscillator). This means, that all the power Π^i , which is input to a subsystem i , must be dissipated (Π_{dis}^i) in this subsystem or must be transmitted into another connected subsystem (Π_{ex}^i).

$$\Pi^i = \Pi_{dis}^i + \Pi_{ex}^i \quad (5)$$

Lyon has found out that this power exchange Π_{ex}^i between two coupled subsystems is proportional to the difference of their total time-averaged energies. Also the total energy is linked via the subsystem damping loss factor η_i to the dissipation power Π_{dis}^i . So it can be written

$$\Pi^i = \omega_c \eta_i E_i + \omega_c \eta_{ij} (E_i - E_j) \quad (6)$$

where ω_c is the central angular frequency of the frequency band and η_{ij} is the coupling loss factor. Moreover, the coupling loss factors of two coupled subsystems are interrelated through the reciprocity relation

$$n_i \eta_{ij} = n_j \eta_{ji} \quad (7)$$

with the modal densities n_i and n_j of subsystems i and j . All in all the energies of the subsystems are calculated with a linear equation system at a given power input. So SEA is principally an easy calculation method, but one problem is the estimation of the coupling loss factors. Also it produces only global results for the average energy of each subsystem without any further detailed informations, like the distribution of these energies. One way to predict the coupling loss factors for the transmission loss calculation of a finite plate between two finite cavities is described by Lyon and DeJong [6]. They divided the process of transmission into two parts, the non resonant and the resonant transmission. The first

is more or less an extended version of the mass law for a diffuse sound field and is characterized by the coupling loss factor η_{12} for the direct coupling between the two cavities.

$$\eta_{12} = \beta_c I_{12} \frac{c_1}{f k_1^2 V_1} \frac{\tau_{12,\infty}(0)}{2 - \tau_{12,\infty}(0)} \quad (8)$$

with the transmission coefficient $\tau_{12,\infty}(0)$ for normal incidence, the correction factor β_c for the case of low modal overlap, the frequency f , the correction factor I_{12} for diffuse sound field and the sound velocity c_1 , the wavenumber k_1 and the volume V_1 of the cavity one. The second part of transmission in the model of Lyon and DeJong, the resonant transmission through the resonant modes of the plate, is represented by an indirect coupling factor η_{p2} . This is related to the plate radiation efficiency σ_{rad} as follows:

$$\eta_{p2} = \frac{\rho_1 c_1}{\omega \rho_p h_p} \sigma_{rad} \quad (9)$$

where ρ_1 and c_1 are the density and the sound velocity of cavity one, ρ_p and h_p are the density and the thickness of the plate and ω is the angular frequency. Finally the basic power balance equation system of SEA reads [11]:

$$\begin{pmatrix} \Pi_1 \\ 0 \\ 0 \end{pmatrix} = A \begin{pmatrix} E_1 \\ E_p \\ E_2 \end{pmatrix} \quad (10)$$

with

$$A = \begin{pmatrix} \eta_1 + \eta_{1p} + \eta_{12} & -\eta_{p1} & -\eta_{21} \\ -\eta_{1p} & \eta_2 + \eta_{p1} + \eta_{p2} & -\eta_{2p} \\ -\eta_{12} & -\eta_{p2} & \eta_2 + \eta_{2p} + \eta_{21} \end{pmatrix}$$

At equal fluids in the both cavities η_{p2} is equal to η_{p1} . The rest of the coupling factors can be obtained from the reciprocity relation (equation (7)). The transmission factor can be then calculated with the estimated energies using the following equation, [9]:

$$\tau = \frac{p_2^2 A_2}{p_1^2 S} \quad (11)$$

where p_2 and p_1 are the effective values of the pressures in cavity one and two, A_2 is the equivalent absorption area of cavity two and S the surface of the plate. The pressure and the equivalent absorption area in a cavity i are given by [1, 11]:

$$p_i = \frac{\rho_i c_i^2 E_i}{V_i} \quad (12)$$

and

$$A_i = \frac{4 \eta_i \omega_c V_i}{c_i} \quad (13)$$

where ρ_i , c_i and V_i are the density, the sound velocity and the volume of cavity i and ω_c is the central frequency of the excited frequency band. To sum up, contrary to the mass law and the formula of Cremer this formulation does not neglect the influence of the cavity parameters, size and damping, and takes into account the finite size of the plate.

2.2 Statistical modal Energy distribution Analysis

The statistical modal energy distribution analysis (SmEdA) is based on the dual formulation of two gyroscopic coupled oscillators [7]. Under the assumption of a white noise excitation the modal coupling loss factor reads:

$$\beta_{pq}^{12} = \frac{(W_{pq}^{12})^2}{M_p^1 M_q^2 (\omega_q^2)^2} \left[\frac{\eta_p^1 \omega_p^1 (\omega_q^2)^2 + \eta_q^2 \omega_q^2 (\omega_p^1)^2}{d} \right] \quad (14)$$

with

$$d = (\eta_p^1 \omega_p^1 + \eta_q^2 \omega_q^2) (\eta_p^1 \omega_p^1 (\omega_q^2)^2 + \eta_q^2 \omega_q^2 (\omega_p^1)^2) + ((\omega_p^1)^2 - (\omega_q^2)^2)^2$$

where W_{pq}^{12} is the interaction modal work and where M_p^1 , M_q^2 , η_1 , η_2 , ω_1 and ω_2 are the modal masses, the damping factors and the eigenfrequencies of the p-th and q-th mode of the subsystems 1 and 2. The coupling loss factors of classical SEA can be calculated then on condition of modal equipartition of energy [13] with the following formulas:

$$\eta_{12} = \frac{1}{p_{max} \omega_c} \sum_{p=1}^{p_{max}} \sum_{q=1}^{q_{max}} \beta_{pq}^{12} \quad (15)$$

$$\eta_{21} = \frac{1}{q_{max} \omega_c} \sum_{p=1}^{p_{max}} \sum_{q=1}^{q_{max}} \beta_{pq}^{12} \quad (16)$$

where p_{max} and q_{max} are the numbers of resonant modes relative to the excited frequency band with the central frequency ω_c . It was shown by some authors, for example by Maxit and Guyader [8] for structure-structure coupling or by Totaro, Dodard and Guyader [13] for structure-cavity coupling, that the coupling factors computed by SmEdA agree well with these obtained by other approaches. Moreover, the energies of the different subsystems can be also calculated directly using β_{pq}^{12} and a power balance equation system with one equation for each mode instead of one for each subsystem like in SEA.

$$\Pi_p^1 = \eta_p^1 \omega_p^1 E_p^1 + \sum_{q=1}^{q_{max}} \beta_{pq}^{12} (E_p^1 - E_q^2) \quad (17)$$

A main drawback of this original SmEdA approach is that because of the assumption of white noise excitation only resonant modes in an excited frequency band are taken into account. But the influence of non resonant modes can be not neglected in some cases, for example in the case of highly damped systems. To find a solution for this problem it is necessary to have a closer look to the original derivation of the method for the case of a cavity-plate coupling. In SmEdA the coupled system is split into a clamped cavity and free plate on the coupling surface to describe the coupling between the pressure in the cavity and the plate velocity. This is the same as the assumption "blocked pressure" in other transmission loss models, where it is assumed that the move of the plate is negligible for the calculation of the surface pressure and the plate is then excited by the resultant force. But of course for the evaluation of the

kinetic energy of the cavity and the potential energy of the plate the boundary conditions must be respected. These conditions are the equality of the velocities \dot{y}_i^b and the equality of the products of the stress tensors σ_{rs}^{ib} and normal vectors n_s^i at the coupling surface.

$$\dot{y}_1^b = \dot{y}_2^b \quad (18)$$

$$\sigma_{rs}^{1b} n_s^1 = \sigma_{rs}^{2b} n_s^2 \quad (19)$$

The latter is not the case in the original SmEdA formulation. Finally the coupled system is defined with four equations, the two coupled differential equations of original SmEdA and the two boundary conditions, but there are only two variables. Such overdetermined systems have in general no exact solution and it is difficult to find an approximate solution. Through trial and error it was found out that the mass law and the formula of Cremer, equations (3) and (4), can be derived analytically with the original coupling factor β_{pq}^{12} , equation (14), and the power balance, equation (17). So β_{pq}^{12} seems to be also the general coupling factor for any coupling of two modes, non resonant and resonant ones, because the coupling in the formula of Cremer is arbitrary and no assumption of white noise is needed. Perhaps this works, because β_{pq}^{12} can be also interpreted as the average coupling loss factor between two modes of all possible single-frequency excitations from zero to infinity. Altogether because of these reasons the non resonant modes are also taken into account in an extended SmEdA approach using β_{pq}^{12} , whereas the excitation still remains in a frequency band only. Finally the obtained energies, the geometrical data and the damping factors of the cavities need only to be inserted in equation (11) to get the transmission factor and so the transmission loss. This transmission loss depends on the same parameters as the one obtained by the SEA approach.

3 Comparison of the approaches

3.1 System under study

To compare the results for the transmission loss of the different calculation methods we consider a basic configuration of a rectangular plate between two parallelepipedic cavities as presented in Figure 1 and Table 1.

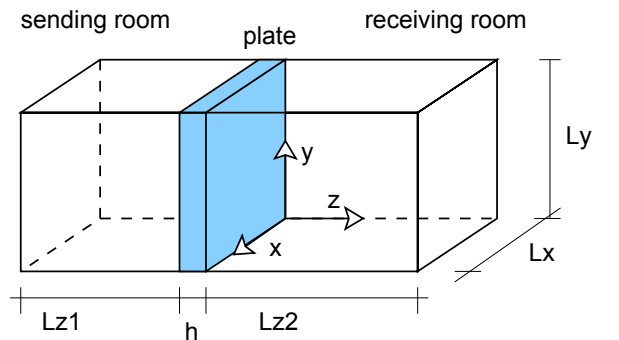

Figure 1: Sketch of the system

| | plate | sending room | receiving room |
|------------------------------------|-------------------------------|-----------------------------|---------------------------|
| $L_x \times L_y \times L_z(h)$ (m) | $1.2 \times 0.9 \times 0.004$ | $1.2 \times 0.9 \times 0.7$ | $1.2 \times 0.9 \times 1$ |
| ρ (kg/m ³) | 7820 | 1.2 | 1.2 |
| c (m/s) | | 340 | 340 |
| η | 0.01 | 0.01 | 0.01 |
| E (MPa) | 210 | | |
| ν | 0.3 | | |

Table 1: Characteristics of the subsystems

In the present case the eigenmodes and eigenfrequencies can be calculated quite easily analytically. The shapes p_{qrs} of the eigenmodes and the eigenfrequencies ω_{qrs} for the cavities are given by [9]

$$p_{qrs} = \cos\left(\frac{q\pi x}{L_x}\right) \cos\left(\frac{r\pi y}{L_y}\right) \cos\left(\frac{s\pi z}{L_z}\right) \quad (20)$$

and

$$\omega_{qrs} = c \sqrt{\left(\frac{q\pi}{L_x}\right)^2 + \left(\frac{r\pi}{L_y}\right)^2 + \left(\frac{s\pi}{L_z}\right)^2} \quad (21)$$

For the plate there is the possibility to choose between different boundary conditions. We take for our study the simply supported and the free boundary condition. The eigenfrequencies ω_{mn}^s and the modes W_{mn}^s of the simply supported boundary condition are

$$\omega_{mn}^s = \pi^2 \left[\left(\frac{m}{L_x}\right)^2 + \left(\frac{n}{L_y}\right)^2 \right] \sqrt{\frac{B}{m}} \quad (22)$$

and

$$W_{mn}^s = \sin\left(\frac{m\pi x}{L_x}\right) \sin\left(\frac{n\pi y}{L_y}\right) \quad (23)$$

with the mass per area m and the bending stiffness B of the plate.

3.2 Transmission Loss

3.2.1 Simply supported plate

At first before we compare the results from the SmEdA approach with those of other models, it is necessary to compare the different possibilities of calculations with SmEdA. So the next two Figures (2 and 3) show the results of transmission loss for different plate damping factors η_2 calculated with

- SEA with SmEdA estimated couplings factors (SmEdA SEA CLF; equations (6), (15) and (16))
- SmEdA direct only with resonant modes (SmEdA resonant; equations (14) and (17))
- SmEdA direct with resonant and non resonant modes (SmEdA non resonant; equations (14) and (17)).

For the last approach the number of modes, that are taken into account, is enlarged until the changes in the transmission loss get small, for example smaller than 1 dB. In our case at the plate damping 0.1 it is necessary to take into account all the modes of the not excited

subsystems from 600 Hz below to 300 Hz above the frequency band (band width: 400 Hz). The non resonant modes of the excited systems, which are also not excited, do not matter.

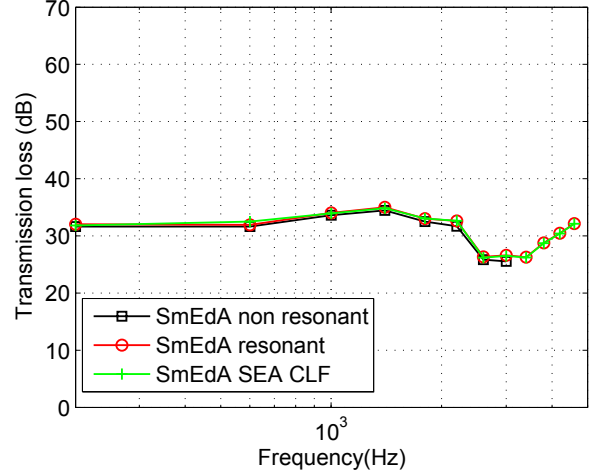

Figure 2: Transmission loss of the different SmEdA models at $\eta_2 = 0.001$

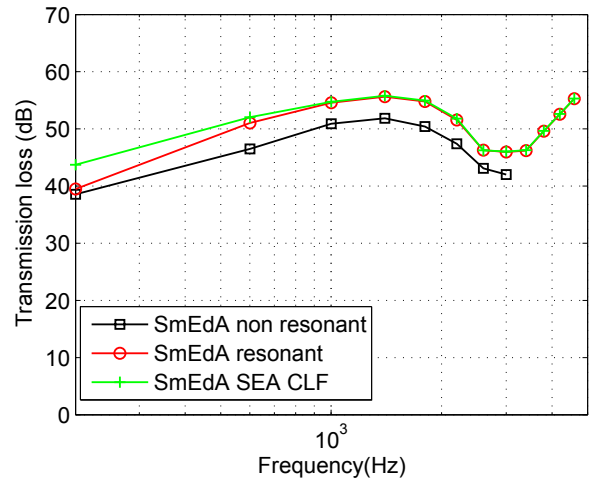

Figure 3: Transmission loss of the different SmEdA models at $\eta_2 = 0.1$

All in all Figures 2 and 3 demonstrate that the case with the simply supported boundaries of the plate is at low damping governed by the resonant modes for the whole frequency range while the non resonant modes play a role only at quite high damping. Furthermore between the SEA calculation with SmEdA coupling factors and SmEdA direct only with resonant modes there is only a difference at low frequencies, because the assumption of modal equipartition of energy (see equation (7)) is generally not valid for low modal densities [5]. Because of these facts only the SmEdA direct calculation without non resonant modes is given in the following figures, except in the case of high damping, where the non resonant modes are needed. Figures 4 to 6 show now for three damping factors η_2 of the plate the different transmission losses predicted with the mass law for normal incidence, the formula of Cremer for a diffuse sound field, the SEA model of Lyon and DeJong and the SmEdA approach.

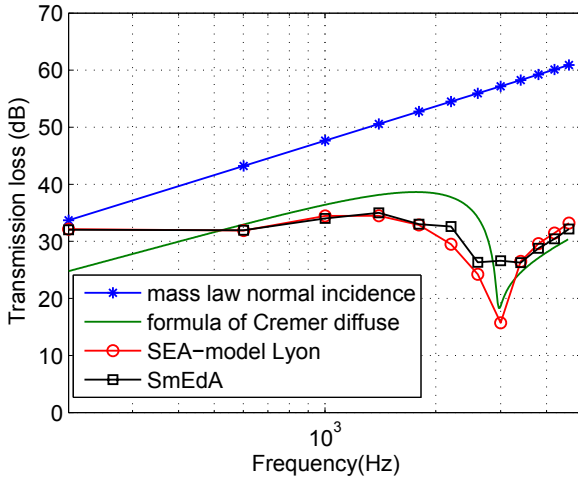

Figure 4: Transmission loss of the different models at $\eta_2 = 0.001$

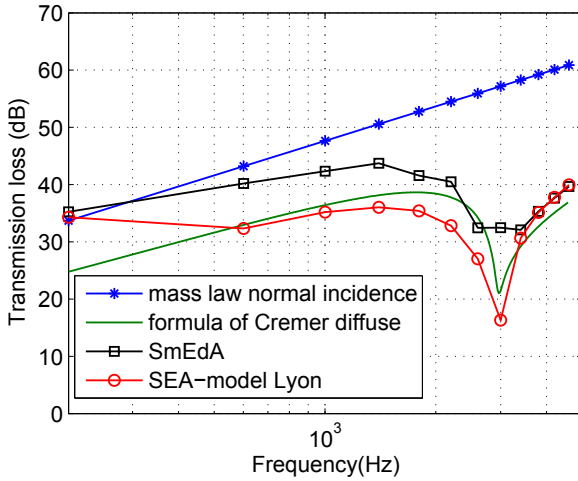

Figure 5: Transmission loss of the different models at $\eta_2 = 0.01$

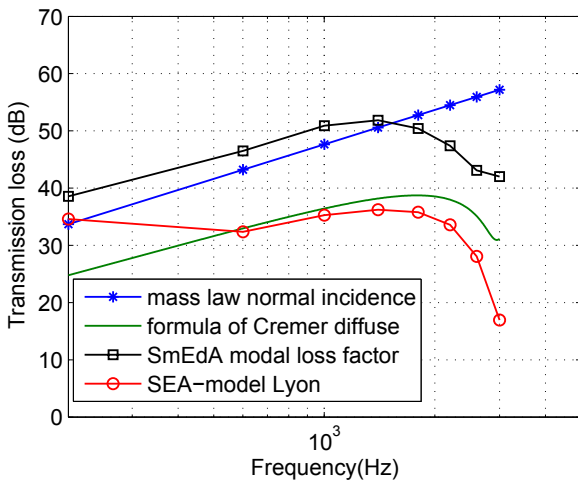

Figure 6: Transmission loss of the different models at $\eta_2 = 0.1$

By looking at the results of the different models it attracts attention that both, the SmEdA and SEA prediction, are sensitive below the critical frequency to a

change of the damping, unlike the formula of Cremer. The main reason for this is that the dissipation of energy of the vibrating plate modes rises with increasing damping, because the coupling factors change only a little. Above the critical frequency the dependency of the transmission loss on the plate damping is then equal for these three models. This difference between the formula of Cremer and the SmEdA approach does not come from different descriptions of the transmission mechanism. Under the same assumptions as for the formula of Cremer (diffuse sound field, infinite plate, etc.) the transmission loss predicted with SmEdA is analytically given by

$$R = 10 \lg \left[1 + S \left(\frac{\cos \vartheta}{2\rho c} \right)^2 \right] \quad (24)$$

with

$$S = \left(\omega m - \omega^3 B \frac{\sin^4 \vartheta}{c^4} \right)^2 + m B \eta^2 \omega^4 \frac{\sin^4 \vartheta}{c^4}$$

This formulation is compared to the original formula of Cremer (equation (4)) in Figure 7 for our configuration and a diffuse sound field (average over all possible incident directions). The damping in this original formula is taken into account via the usual assumption of a complex bending stiffness $\hat{B} = B(1 - i\eta_2)$.

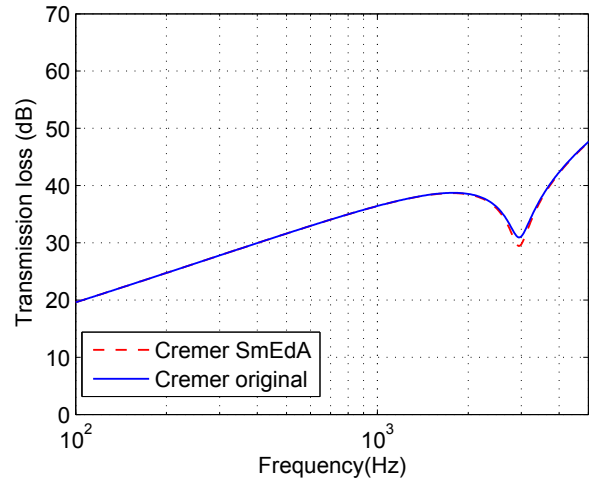

Figure 7: Transmission loss of the infinite models from Cremer and SmEdA at $\eta_2 = 0.1$

It could be seen, there is only a small difference at the critical frequency between the two formulations. To sum up, this means that the transmission loss of a small system, where we have a small plate and no diffuse field at lower frequencies, is quite different than the one of a big or infinite one below the critical frequency but stays equal above it.

3.2.2 Free plate

As a second example for a plate boundary, the free boundary condition was chosen. In Figure 8 the calculation possibilities of SmEdA with and without non resonant modes and the formula of Cremer are compared. In this case the plate is 1 cm thick and not 4 mm as in the calculations for the simply supported plate.

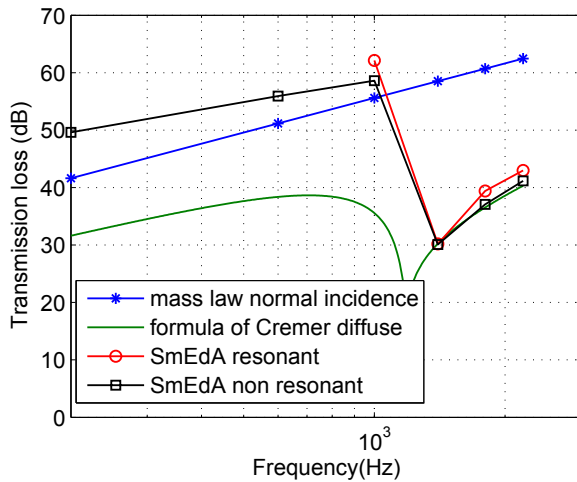

Figure 8: Transmission loss of the different models at $\eta_2 = 0.01$

Using the original SmEdA calculation, i.e. only with resonant modes, the transmission loss becomes infinite below the critical frequency. This means that all modal works between the resonant modes are zero. Thus it is necessary to take into account below the critical frequency all the modes from zero Hz to the upper limit of the frequency band, because the energy transfer proceeds only through the non resonant modes. This shows, that the configuration with a free boundary condition has a non resonant behaviour below the critical frequency and a more or less resonant above it. In comparison to the formula of Cremer the transmission loss calculated with SmEdA is much higher. One reason for this is the small number of energy transporting combinations of plate and cavity modes. In addition to this no diffuse sound field exists in such a small system with lots of modes, which could excite the plate better.

4 Conclusion

As it is shown on the previous examples, the presented new method to estimate the transmission loss with SmEdA is an interesting alternative to the other existing prediction models, especially in the frequency range below the critical frequency and for small systems with non diffuse fields. Furthermore this method demonstrates that the transmission loss can be smaller or much higher in this frequency range than the one predicted by the infinite models. Another important advantage is the very general formulation of the transmission problem. So not only the presented cases of a simply supported and a free plate between to finite cavities can be handled but also cases with arbitrary plate boundaries and complex geometries. Also it would be, for example, possible to predict the transmission loss with SmEdA for window assemblies, where the plate is smaller than the corresponding walls of the cavities. The only limits are the estimation of the modes and the computation time growing with a rising number of modes, which are taken into account.

5 Acknowledgment

The authors gratefully acknowledge the ITN Marie Curie project GA-214909 "MID-FREQUENCY - CAE Methodologies for Mid-Frequency Analysis in Vibration and Acoustics".

References

- [1] Bruneau M., "Fundamentals of acoustics", *ISTE* (2006)
- [2] Gagliardini L., Roland J., Guyader J.-L., "The use of a functional basis to calculate acoustic transmission between rooms", *J. Sound Vib.* 145(3), 457-478 (1991)
- [3] Heckl M., "The tenth Sir Richard Fairey memorial lecture: Sound transmission in buildings", *J. Sound Vib.* 77(2), 165-189 (1981)
- [4] Josse R., Lamure C., "Transmission du son par une paroi simple", *Acustica* 14, 266-280 (1964)
- [5] Le Bot A., Cotoni V., "Validity diagrams of statistical energy analysis", *J. Sound Vib.* 329, 221-235 (2010)
- [6] Lyon R. H., DeJong R. G., "Theory and application of statistical energy analysis", *Butterworth-Heinemann*, 2nd ed. (1995)
- [7] Maxit L., Guyader J.-L., "Estimation of the SEA coupling loss factors using a dual formulation and FEM modal information, part I: Theory", *J. Sound Vib.* 239(5), 907-930 (2001)
- [8] Maxit L., Guyader J.-L., "Estimation of the SEA coupling loss factors using a dual formulation and FEM modal information, part II: Numerical applications", *J. Sound Vib.* 239(5), 931-948 (2001)
- [9] Möser M., "Technische Akustik", *Springer-Verlag*, 7th ed. (2007)
- [10] Nilsson A. C., "Reduction Index and boundary conditions for a wall between two rectangular rooms, part I: Theoretical results", *Acustica* 26, 1-18 (1972)
- [11] Renji K., Nair P. S., Narayanan S., "Non-resonant response using statistical energy analysis", *J. Sound Vib.* 241(2), 253-270 (2001)
- [12] Sakuma T., Oshima T., "Numerical Analysis of Sound Transmission Loss of Glass Pane - On the Treatment of Edge Damping", *Proc. Inter-noise 2008 (Shanghai)*
- [13] Totaro N., Dodard C., Guyader J.-L., "SEA coupling loss factors of complex vibro-acoustic systems", *Journal of Vibration and Acoustics* 131, 041009-1-041009-8 (2009)
- [14] Woodcock R., Nicolas J., "A generalized model for predicting the sound transmission properties of generally orthotropic plates with arbitrary boundary conditions", *J. Acoust. Soc. Am.* 97(2), 1099-1112 (1995)