



**HAL**  
open science

# EXPERIMENTAL COMPARISON OF LAMINATION MATERIAL CASE OF SWITCHING FLUX SYNCHRONOUS MACHINE WITH HYBRID EXCITATION

Emmanuel Hoang, Sami Hlioui, Michel Lécivain, Mohamed Gabsi

► **To cite this version:**

Emmanuel Hoang, Sami Hlioui, Michel Lécivain, Mohamed Gabsi. EXPERIMENTAL COMPARISON OF LAMINATION MATERIAL CASE OF SWITCHING FLUX SYNCHRONOUS MACHINE WITH HYBRID EXCITATION. EPE 2009, Sep 2009, Barcelona, Spain. hal-00533013

**HAL Id: hal-00533013**

**<https://hal.science/hal-00533013>**

Submitted on 4 Nov 2010

**HAL** is a multi-disciplinary open access archive for the deposit and dissemination of scientific research documents, whether they are published or not. The documents may come from teaching and research institutions in France or abroad, or from public or private research centers.

L'archive ouverte pluridisciplinaire **HAL**, est destinée au dépôt et à la diffusion de documents scientifiques de niveau recherche, publiés ou non, émanant des établissements d'enseignement et de recherche français ou étrangers, des laboratoires publics ou privés.

# EXPERIMENTAL COMPARISON OF LAMINATION MATERIAL CASE OF SWITCHING FLUX SYNCHRONOUS MACHINE WITH HYBRID EXCITATION

Emmanuel HOANG, Sami HLIQUI, Michel LECRIVAIN, Mohamed GABSI

SATIE - ENS Cachan, UMR CNRS 8029, Cachan FRANCE

Phone number: (33) 1 47 40 21 11

E-mail: hoang@satie.ens-cachan.fr

**Abstract:** The aim of this paper is to compare the experimental performances of a new hybrid flux switching synchronous machine built with two types of lamination materials (3% silicon iron steel M330-50 and NO-20). This machine uses the flux switching principle where all the active parts are located on the stator (armature windings and permanent magnets). However DC excitation coils were added in the stator and gives a supplementary degree of freedom used control the total excitation flux. The rotor is only a salient passive rotor and can be robust and made with a low cost technology. This new machine can be supplied by means of a traditional three-phase voltage converter or can be associated with a diode rectifier.

**Keywords:** Synchronous machine, permanent magnet, flux switching, flux weakening, hybrid excitation, magnetic losses.

## 1 Introduction

In a previous article [1], we introduced a new synchronous machine [2] called hybrid flux switching synchronous machine. It has two excitation flux sources: permanent magnets and DC excitation coils. The advantages and opportunities of such structure for new applications, where operating points are highly variable, were presented.

The first advantage of this machine's topology is its passive rotor. Indeed, it only consists of a stack of ferromagnetic steel, thus allows high rotational speeds. The second advantage is that all the active parts are located on the static part of the machine, allowing better heat transfer.

Moreover, this machine has a high normalised inductance in the 'd' axis ( $L_d^*$ ), so has good flux weakening capabilities when it is fed by a voltage inverter. Indeed, the ratio between the short-circuit current density and thermal current density may be less than unity.

In this paper, all the points presented previously will be firstly identified. After that, the influence of the quality of lamination material choice is studied [3-5] by using two identical machines with two different 3% silicon steel types. The first one is made with quality sheets M330-50 (thickness 0.50 mm), and the second one with steel NO-20 (thickness 0.20 mm).

## 2 Machine presentation

In order to explain the operating principle of this hybrid flux switching synchronous machine with a hybrid excitation [1], an elementary magnetic cell is used (Fig. 1). From this elementary cell, a prototype was developed as shown on Fig. 2 (mechanical and electrical characteristics are given in appendix). One can notice that this structure uses the flux switching and flux concentration principals.

Machine's stator includes armature coils, permanent magnets and a wound inductor and its salient rotor is simply made of stacked, soft iron sheets. The prototype is a three-phase machine containing twelve magnets, with each phase composed of four magnets and four concentric coils. The rotor contains  $N_r$  teeth ( $N_r = 10$ ), and the relation between the mechanical rotation frequency  $F$  and the electrical frequency  $f$  can be expressed as:  $f = N_r F$ .

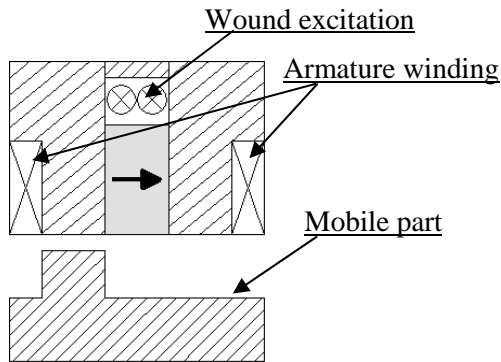

Fig.1: Elementary cell of the machine

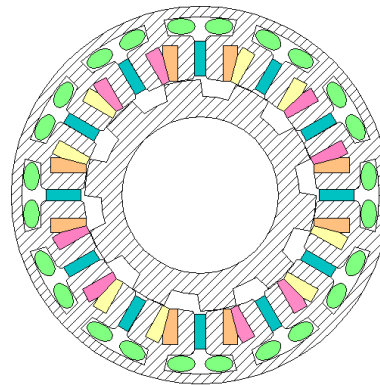

Fig.2: Cross section of a three-phase prototype

### 3 Experimental test bench presentation

The assembly experimental test bench is shown on figure 3. An induction machine, MAS (3000 rpm – 5 kW), supplied with an inverter can be used in motor mode or in generator mode. The DC-bus voltage ( $U_{DC} = 300\text{ V}$ ) is the same for the two converters. With the contactors  $K_{MAS}$  and  $K_{MS}$  and with the coupling A, we can have different possibility to test the prototype, MS. For example, When  $K_{MAS}$  and  $K_{MS}$  are conducting and MS and MAS coupled, the total power ( $U_{DC} \times I_{OT}$ ) is equal to the sum of all losses.

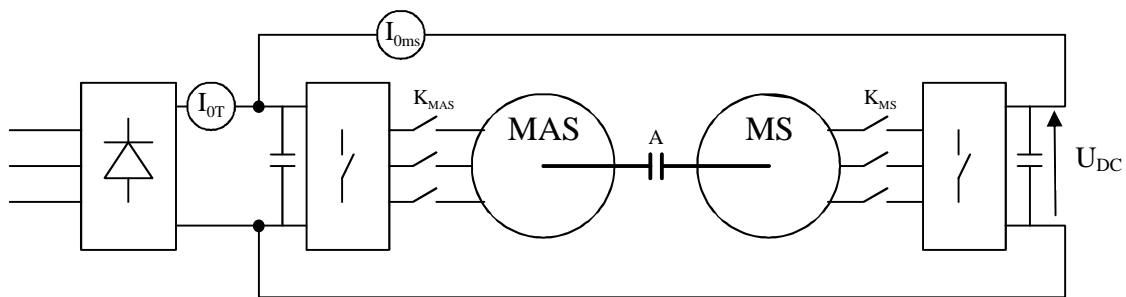

Fig. 3: Experimental test bench

### 4 Measurement presentation

On figure 4, we specify the experimental measurements that were made.

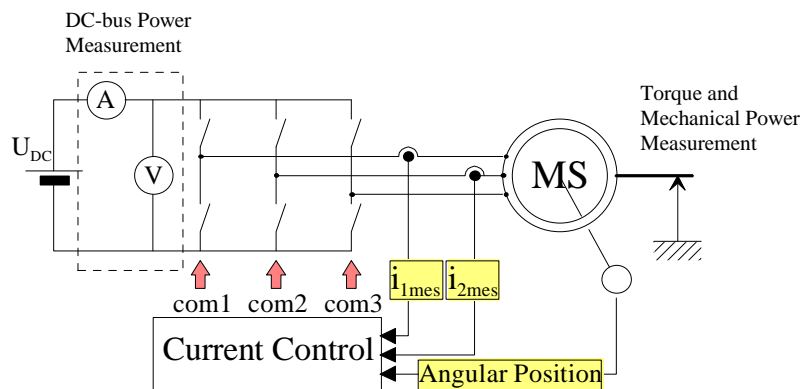

Fig. 4: Diagram of current regulated - machine drive

By virtue of its passive rotor, this machine displays highly robust qualities. Moreover, it is capable of attaining a good level of performance (continuous thermal specific torque). In association with a three-phase voltage converter, this machine can work with a constant maximum power over a theoretically infinite range of speeds in the flux weakening mode [8], [9] and [10].

We have examined the machine's power capabilities with respect to the DC-bus voltage converter ( $U_{DC}$ ) and the values of iron losses.

To quantify mechanical power, the torque is measured with a mechanical assembly balance.

Currents are controlled with hysteresis comparators, with the regulation technique diagrammed below in Fig. 5.

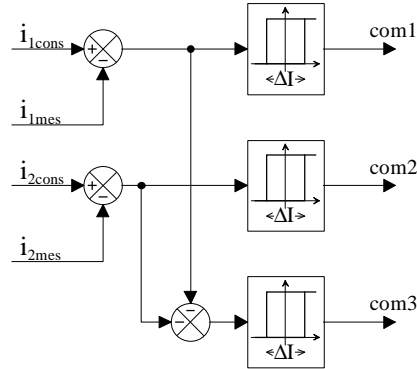

Fig.5: Current control by hysteresis regulator

At low speeds, the current is well-regulated (Fig. 6). However, in flux weakening mode, at high speeds, we apply the maximum voltage and the current is limited by both the EMF and the machine's impedances (Fig. 7). In this case, the converter losses are only conduction losses.

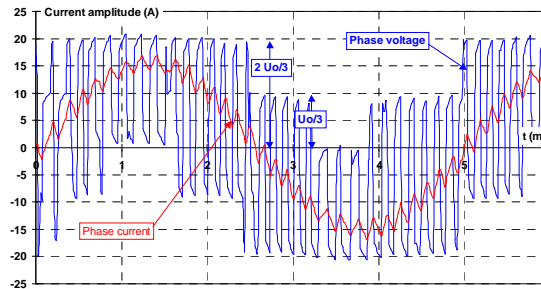

Fig.6: Experimental voltage and current at low speed

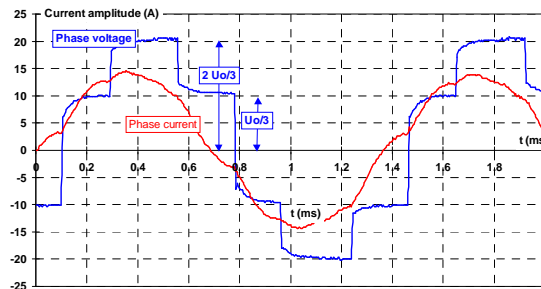

Fig. 7: Experimental voltage and current at high speed

To obtain the value of iron losses, the method of loss separation is applied:

$$P_{\text{iron}} = P_{\text{in}} - P_{\text{conv}} - P_{\text{co}} - P_{\text{mech}} - P_{\text{out}}$$

$P_{\text{iron}}$ : Iron losses

$P_{\text{in}}$ : Input power measured at the DC bus ( $U_{DC} \times I_{0ms}$ )

$P_{\text{conv}}$ : Converter losses (mosfet transistor:  $r_{\text{DS(on)}} = 0.25\Omega @ T_j=125^\circ\text{C}$ )

$P_{\text{co}}$ : Copper losses (Phase resistor =  $0.5\Omega @ T_{co}=100^\circ\text{C}$ )

$P_{\text{mech}}$ : Mechanical losses (bearing losses and air friction losses, cf. Fig. 8)

$P_{\text{out}}$ : Output mechanical power (Torque  $\times$  rotation speed)

The mechanical losses are measured in open circuit mode, the permanent magnets are removed and the field current is null.

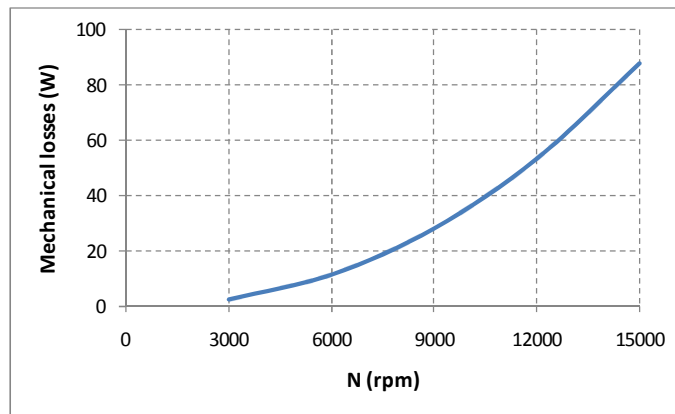

Fig. 8: Bearing and air friction losses

To make a comparison, at the rated armature current  $P_{co} = 110$  W and  $P_{conv} = 55$  W.

## 5 Magnetic material presentation

For both types of steel, the characteristics of magnetization are almost similar (Fig.9).

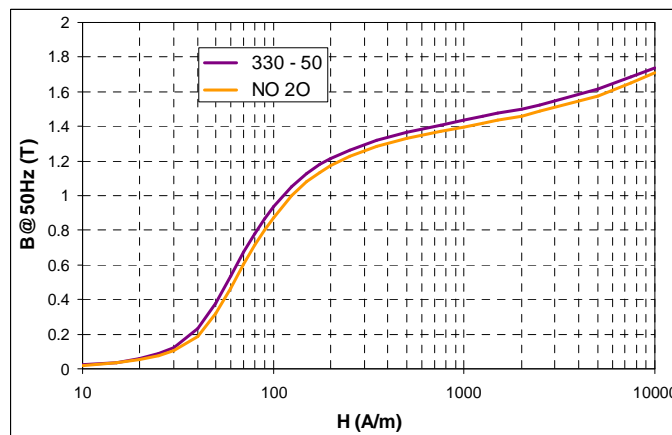

Fig. 9: characteristics of magnetization

However, Specific iron losses for this two laminated steels are different and are given on the table below.

$B_M$ (T)	f (Hz)	Iron losses (W/kg)	
		M330-50	NO-20
1.5	50	3.2	2.9
1.5	400	76	38
1.5	700	233	98

Table n° 1: Specific iron losses

## 6 Characteristics

The adjustable part of the excitation, with the DC excitation coils, permit to adjust the amplitude of the flux (cf. table n° 2), the level of the maximum convertible power and the level of iron losses (cf. Fig. 10-11-12). We have demonstrated, experimentally, that the iron losses change the efficiency value, but also the maximum convertible power by the machine associated with a voltage inverter (cf. Fig. 10).

Excitation current $n I_e$ (At)	No load voltage at 3000 rpm ( $V_{rms}$ )	
	M330-50	NO-20
0	53	52
4800	91	88

Table n° 2: No-load voltage

There are three areas in the characteristic convertible power – speed rotation (Fig.10).

In area ❶, currents are limited and it's a torque command.

In area ❷, voltages are limited by converter capability and it's a power command with flux-weakening mode. Difference between the two characteristics, for a same excitation level and two different magnetic materials, is nearly constant.

For steel NO-20, mechanical power is greater than with M330-50 lamination steels ( $\approx 5\%$ ). This difference can be explained by the characteristics of the steel (Fig. 9), but perhaps by the realization of mechanical differences. Indeed, the size of the machine (Inner diameter = 80 mm) is not enough to be insensitive to mechanical tolerances.

In area ❸, hence the voltage is limited by the inverter and it is a power command with the flux-weakening mode. The difference between the two curves for the same excitation and two different materials increases when the rotational speed increases. Indeed, it was shown [1] that for this type of machine, reducing the maximum power convertible is mainly due to iron losses. Accordingly, for the machine with steel M330-50, this decrease is more important.

We have also shown that the iron losses in load and no-load are almost the same. We can check this, with the curves of iron losses in no-load condition (see Fig. 11 and Fig. 12) and that the difference between the actually maximum converted power in the area ❸ and effectively converted power decrease due to losses iron.

Indeed, the machine with steel NO-20 can convert a greater power over a greater speed range.

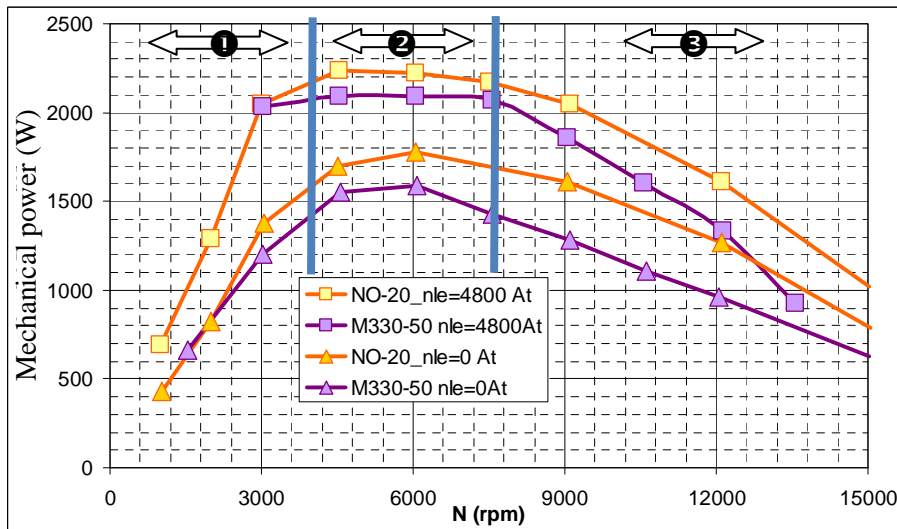

Fig. 10: Mechanical power for two different excitation levels

This machine, with a significant poles pairs number ( $p = N_r = 10$ ), does not seem suitable for use in high rotational speeds (i.e.  $N=3000$  rpm  $\Rightarrow$   $f=500$  Hz). However, experimentally, we have observed that the magnetic material has fewer losses than those indicated by models (cf. Fig. 13 and Fig. 14).

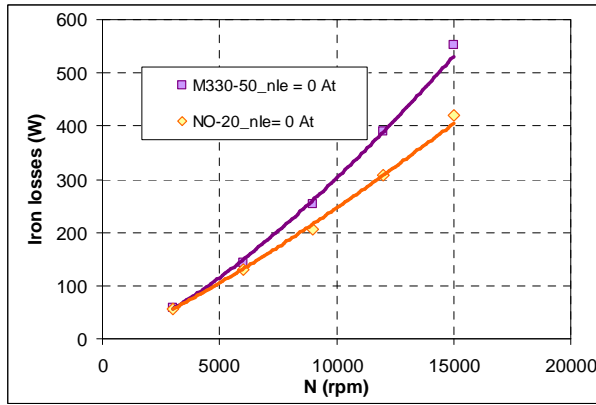

Fig. 11: Iron losses in no load condition @  $n I_c = 0$  At

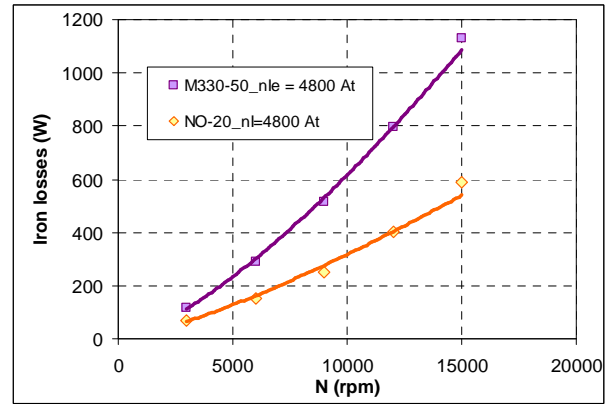

Fig. 12: Iron losses in no load condition @  $n I_c = 4800$  At

We have to determine experimentally using a model iron losses where it is assumed that the induction is uniform across the machine, both stator and rotor. This allows us to compare the experimental model average specific iron losses determined for induction sinusoidal amplitude defined.

We can observe that:

- On the speed range considered ( $N=15000$  rpm  $\Rightarrow f=2500$  Hz), average losses are lower than the specific iron losses in the case of steel M330-50 and above the specific iron losses in the case of NO-20.
- In both cases the variation of loss in function of the frequency is lower.
- The hysteresis term in iron losses is greater in both cases compared with the specific iron losses.

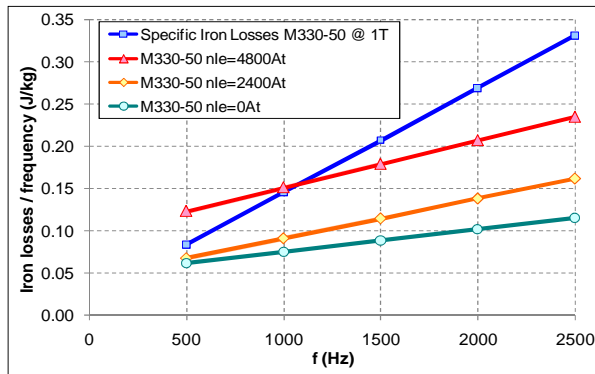

Fig. 13: Comparison of iron losses for M330-50 steel

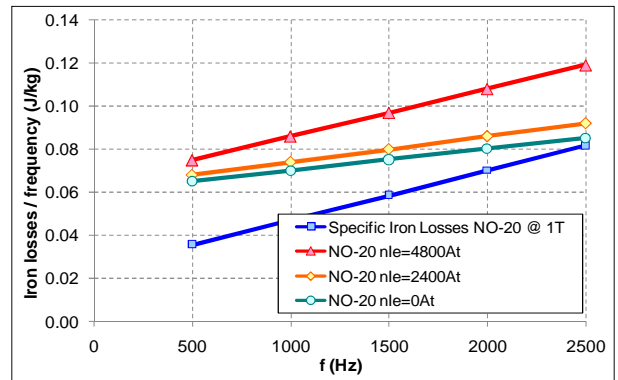

Fig. 14: Comparison of iron losses for NO-20 steel

## 7 Conclusion

In this article we compared the effects of the quality of lamination material for a new flux switching synchronous machine with hybrid excitation. We show that they have a first order of importance on the possibility of energy conversion. We show also the behaviour of these steel in high frequency, and we show that the iron loss is fewer than those expected for this new structure of machine.

## 8 References

- [1] E. HOANG, M. LÉCRIVAIN, M. GABSI  
*A new structure of a switching flux synchronous poly-phased machine with hybrid excitation*  
EPE-2007 Conference, Aalborg, September 2007.
- [2] E. HOANG, M. LÉCRIVAIN, M. GABSI  
*Flux-switching dual excitation electrical machine*  
International patent n° PCT/EP2007/052167, 8 March 2007.
- [3] D. BINESTI and J.P. DUCREUX  
*Core Losses and Efficiency of Electrical Motors Using New Magnetic Materials*  
IEEE transaction on magnetics, vol. 32, n°5, pp 4887-4889, Sept. 1996
- [4] J. J. H. PAULIDES, G. W. JEWELL, and D. HOWE  
*An evaluation of alternative stator lamination materials for a high-speed, 1.5 MW, permanent magnet generator*  
IEEE transaction on magnetics, vol. 40, n°4, pp 2041-2043, July 2004.
- [5] M. CENTNER, R. HANITSCH, U. SCHÄFER  
*Comparison of high-speed induction motors employing cobalt-iron and silicon electrical steel*  
ICEM-2008 Conference, paper ID 1386, September 2008.
- [6] Z. Q. ZHU, Y. S. CHEN, D. HOWE  
*Iron loss in permanent-magnet brushless AC machines under maximum torque per ampere and flux weakening Control.* IEEE transaction on magnetics, vol. 38, n°5, pp 3285-3287, Sept. 2002.
- [7] B. STUMBERGER, A. HAMLER, B. HRIBERNIK  
*Analysis of iron loss in interior permanent magnet synchronous motor over a wide-speed range of constant output power operation.* IEEE transaction on magnetics, vol. 36, n°4, pp 1846-1849, July 2000.
- [8] W.L. SOONG, Prof. T.J.E. MILLER  
*Field-weakening performance of brushless synchronous AC motor drives*  
IEE Proc.-Elect. Power Appl., Vol. 141, n° 6, pp. 331-340, November 1994.
- [9] T.M. JAHNS  
*Flux-weakening regime operation of an interior permanent-magnet synchronous motor drive*  
IEEE Trans. on Industry Applications, Vol. IA-231, n° 4, pp. 681-689, July/August 1995.
- [10] R.F. SCHIFERL, T.A. LIPO  
*Power capability of salient pole permanent magnet synchronous motors in variable speed drive applications*  
IEEE Trans. on Industry Applications, Vol. 26, n° 1, pp. 115-122, January/February 1995.

## 9 Appendix

Mechanical characteristics	Electrical characteristics
External diameter : 130 mm	Flux linkage (rated excitation) : 42 mWb
Inner diameter : 80 mm	Rated armature current : 8.5 A
Airgap length : 0.2 mm	Rated excitation current : 10 A
Stack length : 30 mm	Rated excitation ampere-turn : 4800 At
Stator iron mass : 1.05 kg	Inductance : 5 mH
Rotor iron mass : 0.86 kg	Phase resistor : 0.5 $\Omega$
Permanent magnet : $N_e F_e B - B_r = 1.2$ T	Excitation resistor : 1.3 $\Omega$
Permanent magnet volume : 18 cm <sup>3</sup> – 0.135 kg	
Armature copper mass : 0.29 kg	
Excitation copper mass : 0.33 kg	