



HAL
open science

The State of the Art of Generators for Wind Energy Conversion Systems

Yassine Amirat, Mohamed Benbouzid, Bachir Bensaker, René Wamkeue

► **To cite this version:**

Yassine Amirat, Mohamed Benbouzid, Bachir Bensaker, René Wamkeue. The State of the Art of Generators for Wind Energy Conversion Systems. *Electromotion*, 2007, 14 (4), pp.163-172. hal-00526679

HAL Id: hal-00526679

<https://hal.science/hal-00526679>

Submitted on 15 Oct 2010

HAL is a multi-disciplinary open access archive for the deposit and dissemination of scientific research documents, whether they are published or not. The documents may come from teaching and research institutions in France or abroad, or from public or private research centers.

L'archive ouverte pluridisciplinaire **HAL**, est destinée au dépôt et à la diffusion de documents scientifiques de niveau recherche, publiés ou non, émanant des établissements d'enseignement et de recherche français ou étrangers, des laboratoires publics ou privés.

The State of the Art of Generators for Wind Energy Conversion Systems

Yassine Amirat, Mohamed Benbouzid, Bachir Bensaker and René Wamkeue

Abstract—Wind Energy Conversion Systems (WECS) have become a focal point in the research of renewable energy sources. This paper provides then a comparative study of past and present generator technologies used in WECS. This study is based on an exhaustive review of the state of the art and on an effective comparison of the performances of the four main topologies that are permanent magnet generators, synchronous generators, induction generators and doubly-fed induction generators. The different generator-WECS schemes are compared on the basis of topology, cost, efficiency, power consumption and control complexity. Moreover, attempts are made to highlight future issues so as to index some emerging solutions.

Index Terms—Wind turbine, WECS, generator, state of the art, comparison.

I. INTRODUCTION

Wind energy conversion is the fastest-growing source of new electric generation in the world and it is expected to remain so for some time. At the end of 2003 the installed wind capacity stands at over 40000 MW, doubling since 1999, and it could exceed 95000 MW by the end of 2008 (Fig. 1). But the higher target is to achieve 12% of the world's electricity from wind power by 2020 [1].

Harnessing wind energy for electric power generation is an area of research interest and at present, the emphasis is given to the cost-effective utilization of this energy resource for quality and reliable power supply. During the last two decades wind turbines have been developed in size from 20 kW to 2 MW, while even larger wind turbines already are being designed. A lot of different concepts have been developed and tested. One important modification is the introduction of pitchable blades, where it is possible to control the wind power input the generator. Another development is on the electrical system, where new concepts also have been industrially implemented.

Y. Amirat* and M.E.H. Benbouzid are with the Laboratoire d'Ingénierie Mécanique et Electrique (LIME), University of Western Brittany, Rue de Kergoat – BP 93169, 29231 Brest Cedex 3, France (phone: +33 2 98 01 80 07; fax: +33 2 98 01 66 43; e-mail: m.benbouzid@ieee.org). *Y. Amirat is also with the Electrical Engineering Department, University of Annaba, 23000 Annaba, Algeria.

B. Bensaker is with the Electrical Engineering Department, University of Annaba, 23000 Annaba, Algeria.

R. Wamkeue is with the Department of Applied Sciences, University of Quebec, Rouyn-Noranda, QC, Canada.

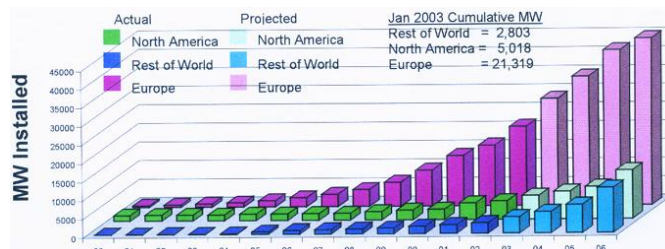

Fig. 1. Installed wind power [1].

These developments have led to conceive many WECS schemes based on many criteria such as fixed speed or variable speed wind turbine, implementation site (onshore or offshore), the rate of the power produced (small or large wind turbine) and the grid connection (islanded or grid connected wind turbine). Indeed, for some years efforts have been put into research and development of new generator concepts [2-5]. For illustration, in [6] a comparison of 7 new concepts is presented.

In this paper, an exhaustive review of the state of the art is presented regarding the four main generator-WECS schemes that are permanent magnet generators, synchronous generators, induction generators and doubly-fed induction generators. These different generator-WECS schemes are compared on the basis of topology, cost, efficiency, power consumption and control complexity. Illustration of the studied generators is provided in Fig. 2.

II. WIND ENERGY BACKGROUND

A. Wind Power Conversion Characteristic

The wind turbine aerodynamic power P is given by

$$P = \frac{1}{2} \pi \rho C_p R^2 v^3 \quad (1)$$

where ρ is the air density, R is the turbine radius, v is the wind speed, and C_p is the turbine power coefficient that represents the wind turbine power conversion efficiency. It is a function of the tip speed ratio λ , as well as the blade pitch angle β in a pitch controlled wind turbine. λ is defined as the ratio of the tip speed of the turbine blades to wind speed, and given by

$$\lambda = \frac{R\Omega}{v} \quad (2)$$

Where Ω is the wind turbine rotational speed.

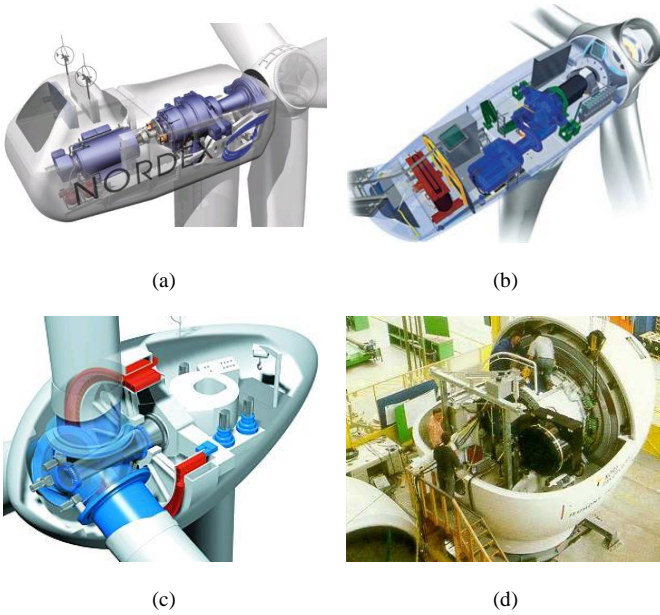

Fig. 2. Frequently used generator topologies:
 (a) Induction generator [© Nordex],
 (b) Doubly-fed induction generator [© NEG Micon],
 (c) Synchronous generator [© Enercon],
 (d) Permanent magnet synchronous generator [© Jeumont Industrie].

The C_p - λ characteristics, for different values of the pitch angle β , are illustrated in Fig. 3. This figure indicates that there is one specific λ at which the turbine is most efficient. Normally, a variable speed wind turbine follows the C_{pmax} to capture the maximum power up to the rated speed by varying the rotor speed to keep the system at λ_{opt} . Then it operates at the rated power with power regulation during high wind periods by active control of the blade pitch angle or passive regulation based on aerodynamic stall. Because wind turbine mechanical power at the rotor hub depends on both rotor speed and wind speed, harvested power can be represented on a three-dimensional surface. Figure 4 is an example of the characteristic power surface of a small turbine. Blade pitch is assumed constant. As expected, power out rises with increasing wind and increasing rotor speed for low and moderate values [7-9].

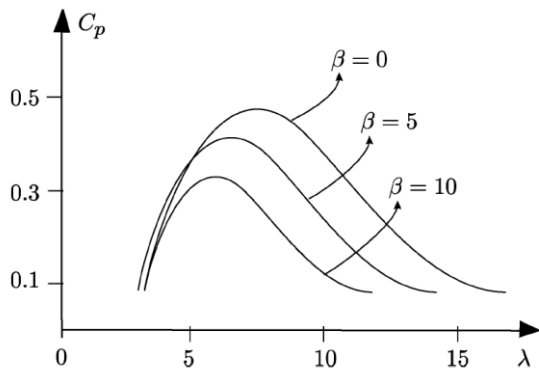

Fig. 3. C_p - λ characteristics, for different values of the pitch angle.

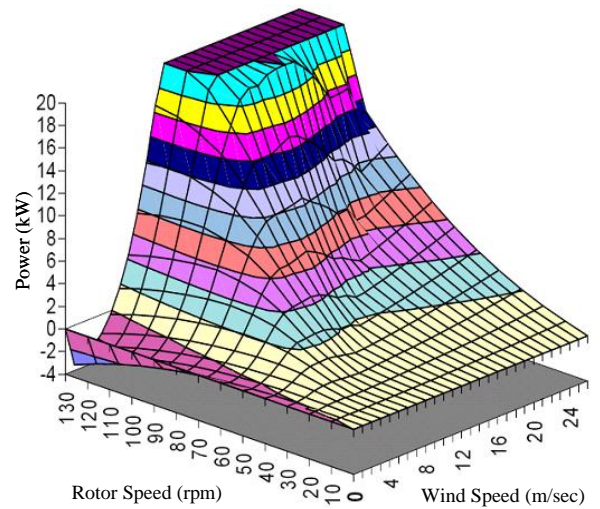

Fig. 4. Generic turbine power surface truncated to 20 kW [9].

B. Wind Turbine Power Extraction

In important issue for wind turbines is the efficiency. Efficiency is important when comparing different systems because losses reduce the average power produced by the wind energy converter and, thereby, they reduce incomes [10]. Therefore, in the following sections, the various WECS that are able to obtain maximum power output for varying wind speeds are discussed (Fig. 5).

Moreover, wind turbine and generator adaptation should be also taken into account. In fact, generators choice is done according the turbine size and wind class (Fig. 6) [2].

III. LITERATURE OVERVIEW

Two types of wind turbines can be distinguished namely fixed speed and variable speed turbines. The first WECS were of fixed speed type due to limitations of machine technology and power electronics [11-12].

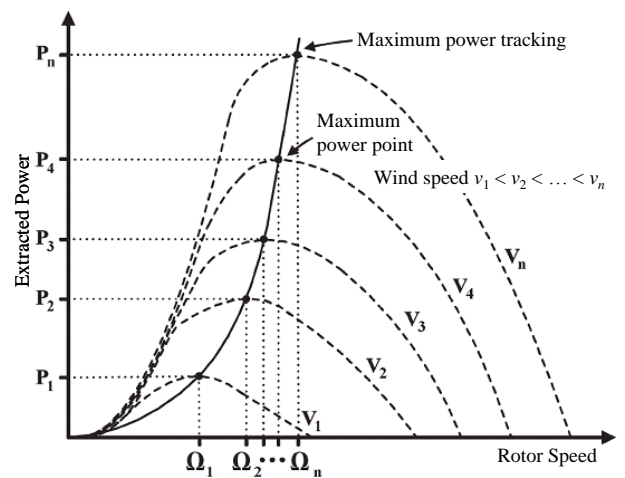

Fig. 5. WECS maximum power extraction.

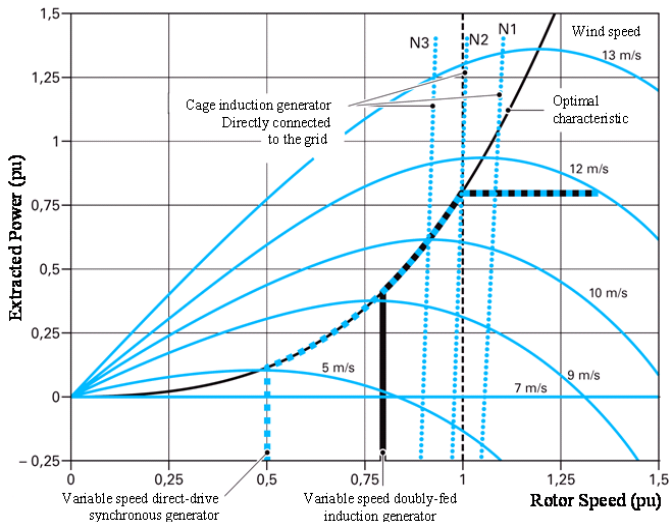

Fig. 6. Wind turbine and generator adaptation [2].

A. Fixed Speed WECS

In a fixed speed WECS, the turbine speed is determined by the grid frequency, the generator pole pairs number, the machine slip, and the gearbox ratio. A change in wind speed will not affect the turbine speed to a large extent, but has effects on the electromagnetic torque and hence, also on the electrical output power. With a fixed speed WECS, it may be necessary to use aerodynamic control of the blades to optimize the whole system performance, thus introducing additional control systems, complexities, and costs. As for the generating system, nearly all wind turbines installed at present use either one of the following systems: squirrel cage induction generator, doubly fed (wound rotor) induction generator, direct-drive synchronous generator. The most used wind turbine systems in this case are illustrated in Fig. 7. Using induction generators will keep an almost fixed speed (variation of 1-2%). The power is limited aerodynamically either by stall, active stall or by pitch control. A soft-starter is normally used in order to reduce the inrush current during start-up. Also a reactive power compensator is needed to reduce (almost eliminate) the reactive power demand from the turbine generators [13-14]. It is usually done by activating continuously the capacitor banks following load variation. Those solutions are attractive due to low cost and high reliability. However, a fixed-speed system cannot extract as much energy from the wind as a variable speed topology. Today the variable speed WECS are continuously increasing their market share, because it is possible to track the changes in wind speed by adapting shaft speed and thus maintaining optimal energy generation [15].

B. Variable Speed WECS

The variable speed generation system is able to store the varying incoming wind power as rotational energy, by changing the speed of the wind turbine, in this way the stress on the mechanical structure is reduced, which also leads to that the delivered electrical power becomes smoother.

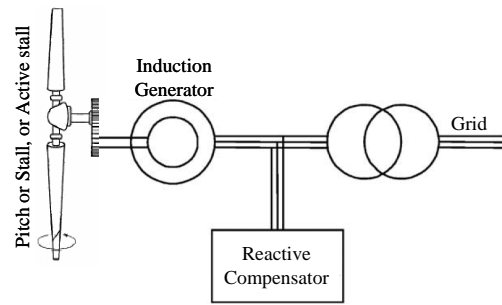

Fig. 7. Frequently used fixed speed WECS.

The control system maintains the mechanical power at its rated value by using the Maximum Power Point Tracking technique (MPPT) [16]. These WECS are generally divided into two categories: systems with partially rated power electronics and systems with full-scale power electronics interfacing wind turbines [13], [17-18].

Figure 8 shows two solutions in case of wind turbines with partially rated power converters. Figure 8a shows a WECS with a wound rotor induction generator. An extra resistance controlled by power electronics is added in the rotor that gives a speed range of 2 to 4%. This solution also needs a softstarter and a reactive power compensator. Figure 8b shows another solution using a medium scale power converter with a wound rotor induction generator. In this case, a power converter connected to the rotor through slip rings controls the rotor currents. If the generator is running super-synchronously, the electrical power is delivered through both the rotor and the stator.

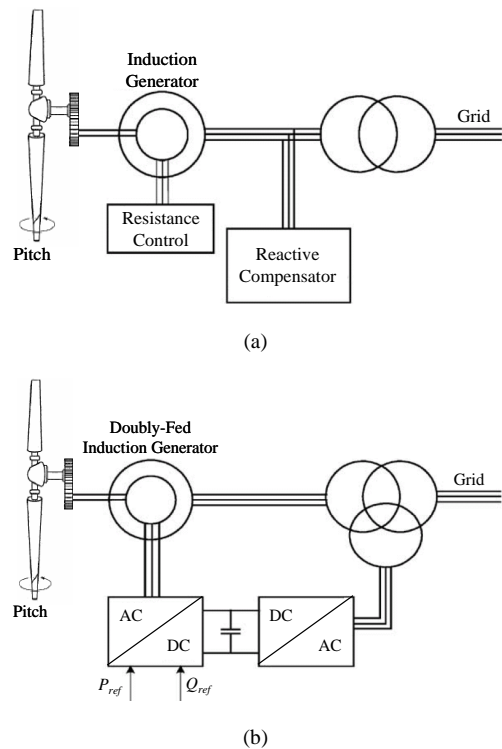

Fig. 8. Partially rated power electronics WECS: (a) Rotor resistance converter, (b) Doubly-fed induction generator.

If the generator is running sub-synchronously the electrical power is only delivered into the rotor from the grid. A speed variation of 60% around synchronous speed may be obtained by the use of a power converter of 30% of nominal power. The other WECS category is wind turbines with a full-scale power converter between the generator and grid that gives extra losses in the power conversion but it will gain the added technical performance. Figure 9 shows in this case four possible solutions using induction generator, multipole synchronous generator and permanent magnet synchronous generator.

C. Generators

Most wind turbine manufacturers use six-pole induction (asynchronous) generators, while others use directly driven synchronous generators [4]. In the power industry, in general, induction generators are not very common for power production, but induction motors are used worldwide.

The power generation industry almost exclusively uses large synchronous generators, as they have the advantage of a variable reactive power production, i.e. voltage control [19-21].

1) *Synchronous generator.* Synchronous generator are widely used in stand alone WECS where the synchronous generator can be used for reactive power control in the isolated network. To ensure the wind turbine connection to the grid a back-to-back PWM voltage source inverters are interfaced between the synchronous generator and the grid. The grid side PWM inverter allows for control of real and reactive power transferred to the grid. The generator side converter is used for electromagnetic torque regulation [22]. Synchronous generators of 500 kW to 2 MW are significantly more expensive than induction generators with a similar size. One should note that the use of a multipole synchronous generator (large diameter synchronous ring generator) avoids the installation of a gearbox as an advantage but a significant increase in weight will be accepted in counterpart. Indeed, the industry uses directly driven variable speed synchronous generators with large-diameter synchronous ring generator. The variable, directly driven approach avoids the installation of a gearbox, which is essential for medium and large-scale wind turbines [4]. Permanent magnet synchronous generator is a solution that is appreciated in small wind turbines but it can not be extended to large-scale power because it involves the use of big and heavy permanent magnets [23-24].

2) *Induction generator.* Induction generators are increasingly used these days because of their relative advantageous features over conventional synchronous generators. These features are brushless and rugged construction, low cost, maintenance and operational simplicity, self-protection against faults, good dynamic response, and capability to generate power at varying speed. The later feature facilitates the induction generator operation in stand-alone/isolated mode to supply far flung and remote areas where extension of grid is not economically viable; in conjunction with the synchronous generator to fulfill the increased local power requirement, and in grid-connected mode to supplement the real power demand of the grid by integrating power from resources located at different sites.

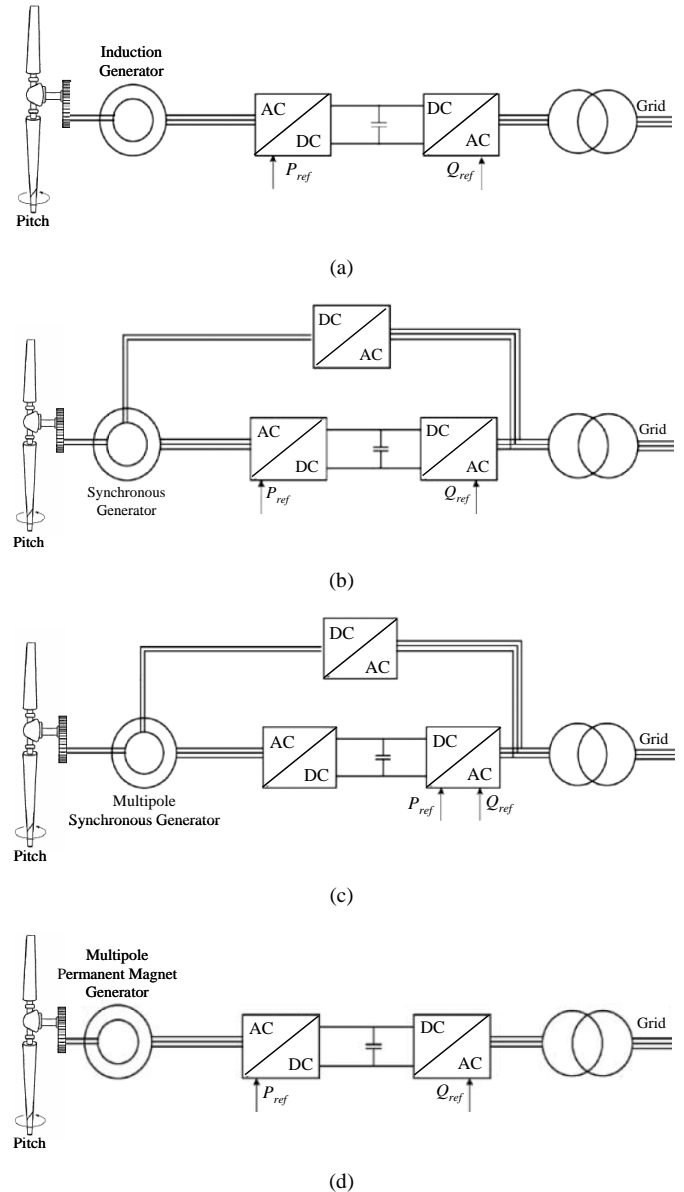

Fig. 9. Full-scale power electronics WECS: (a) Induction generator, (b) Synchronous generator, (c) Multipole synchronous generator, (d) Multipole permanent magnet generator.

The reactive power requirements are the disadvantage of induction generators. This reactive power can be supplied by a variety of methods, from simple capacitors to complex power conversion systems [25-28].

Induction generators were used for a long time in a constant speed WECS, where the pitch control or active stall control are dictated for power limitation and protection, a softstarter is also used to limit transients when the generator is connected to the grid. For variable speed WECS, back to back PWM inverters are used, where the control system of the inverter in the generator side regulates the machine torque and consequently the rotor speed, therefore keeping the frequency within defined limits. On the other hand, the inverter in the grid side controls the reactive power at the coupling point. In this case, the doubly-fed induction

generator is widely used. Indeed, amongst many variable speed concepts, WECS using doubly-fed induction generators have many advantages over others [9]. For example, the power converter in such wind turbines only deals with rotor power, therefore the converter rating can be kept fairly low, approximately 20% of the total machine power. This configuration allows for variable speed operation while remaining more economical than a series configuration with a fully rated converter. Other features such as the controllability of reactive power help doubly-fed induction generators play a similar role to that of synchronous generators [29-32].

D. WECS Efficiency Based Comparison

Table 1 briefly gives the pros and cons of the major WECS detailed in the literature. Moreover as previously mentioned, some of the reviewed WECS were also compared on an efficiency basis. Indeed, Fig. 10 given in [33-34] illustrates wind turbines comparison regarding their energy conversion. Moreover, in [5] is investigated the effects of drive train and power converter efficiencies on variable speed energy capture. In this study, it was found that the losses in the lower wind speed range for an induction generator operating at variable speed with conventional power electronics are fairly large. Switching to a hypothetical power converter with constant 90% efficiency over its operating range recovers the low wind speed losses as illustrated in Fig. 11. Using a direct drive permanent magnet generator with its high efficiency at low power rating improves the situation still further and provides a significant energy capture improvement over the entire operating range. This analysis clearly shows the importance of component efficiencies for capitalizing on the energy capture benefits of variable speed wind turbines [35].

IV. WIND TURBINE MANUFACTURERS

As for the generating system, nearly all wind turbines currently installed use either one of the following systems (Fig. 12): squirrel-cage induction generator, doubly-fed (wound rotor) induction generator, or direct-drive synchronous generator.

Apart from these three mainstream designs, a number of manufacturers have developed other technologies over time. Some of these have survived; others have passed into oblivion (Table 2) [36].

V. TRENDS AND ALTERNATIVES

During recent years, a substantial scaling up has taken place in the wind power area. This applies both to the size of the individual turbine and to the scale of the typical project. For modern wind turbines of the multi-MW class, both the nacelle height and the rotor diameter are in the order of 100 m. Thus, at the vertical position, the blade tip can reach up to heights of 150 m. Figure 13 shows the German Enercon E-112 wind turbine, which, with a rotor diameter of 112 m and a nominal power of 4.5 MW, is currently the largest wind turbine.

Table 1. WECS generator comparison.

Type	Pros	Cons
Induction Generator	<ul style="list-style-type: none"> ✓ Full speed range ✓ No brushes on the generator ✓ Complete control of reactive and active power ✓ Proven technology 	<ul style="list-style-type: none"> ✗ Full scale power converter ✗ Need for gear
Synchronous Generator	<ul style="list-style-type: none"> ✓ Full speed range ✓ Possible to avoid gear ✓ Complete control of reactive and active power 	<ul style="list-style-type: none"> ✗ Small converter for field ✗ Full scale power converter
Permanent Magnet Synchronous Generator	<ul style="list-style-type: none"> ✓ Full speed range ✓ Possible to avoid gear ✓ Complete control of reactive and active power ✓ Brushless (low maintenance) ✓ No power converter for field 	<ul style="list-style-type: none"> ✗ Full scale power converter ✗ Multipole generator (big and heavy) ✗ Permanent magnets needed
Doubly-Fed Induction Generator	<ul style="list-style-type: none"> ✓ Limited speed range -30% to 30% around synchronous speed ✓ Inexpensive small capacity PWM Inverter ✓ Complete control of reactive and active power 	<ul style="list-style-type: none"> ✗ Need slip rings ✗ Need for gear

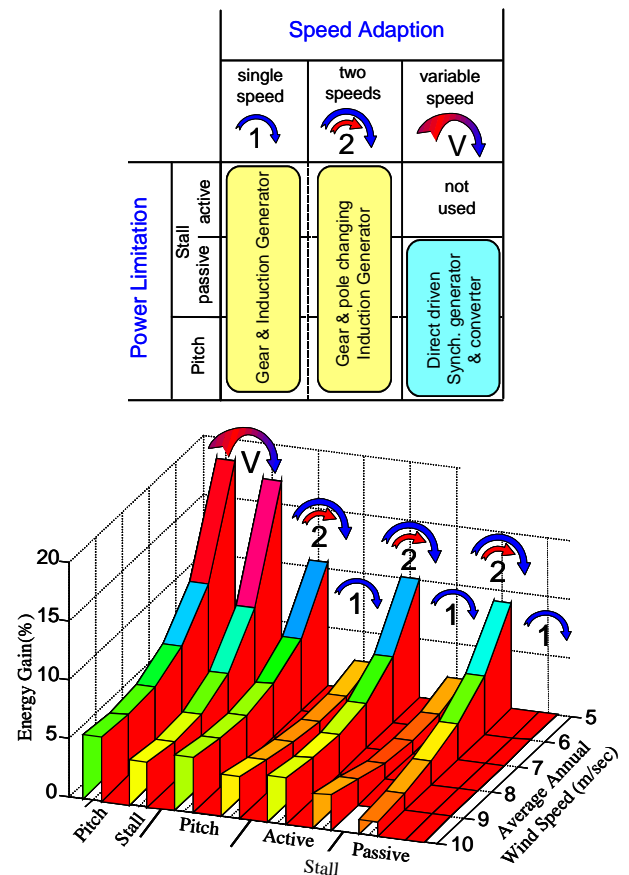

Fig. 10. WECS comparison regarding their energy generation [32-33].

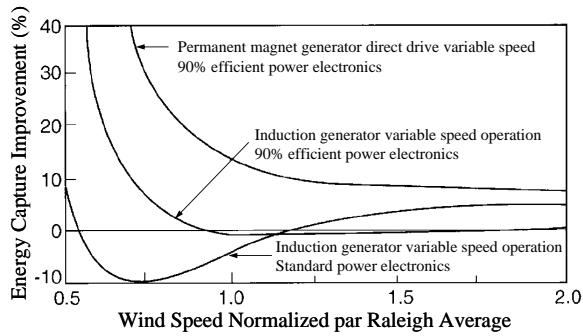
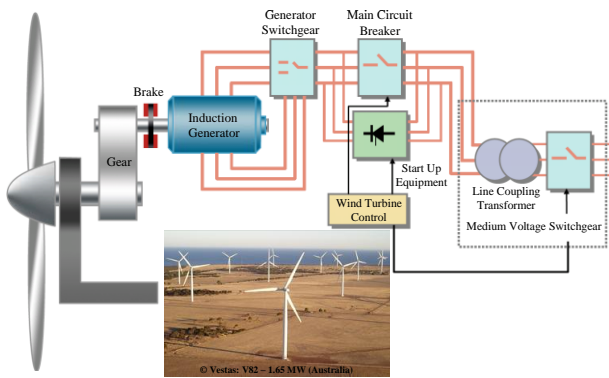
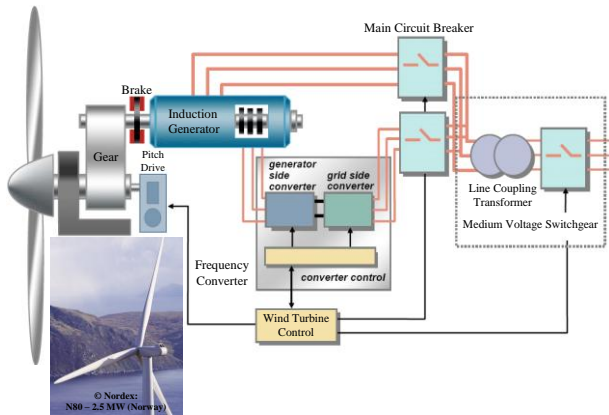

Fig. 11. Energy capture improvement for three WECS configurations [34].



(a) Induction generator directly coupled to grid.



(b) Doubly-fed induction generator with slip energy recovery

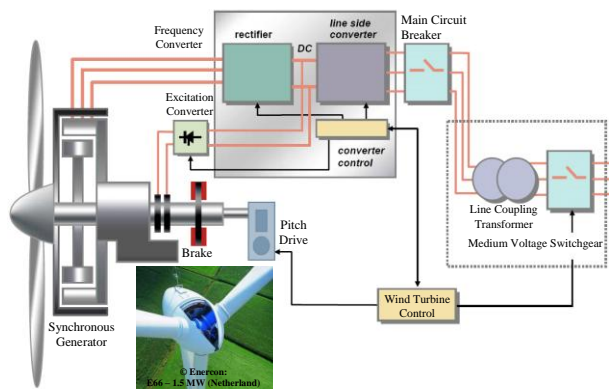

(c) Gearless synchronous generator with high pole number.

Fig. 12. Currently installed WECS.

Table 2. WECS manufacturers current designs and power ranges [36]: CT/CS (fixed speed, classic stall), CT/AS (fixed speed, active stall), VTDI (variable speed/pitch doubly-fed induction generator), VTDD (variable speed, direct-drive synchronous generator) VT/AGP (variable speed/pitch combined with induction generator), SVT/OSP (semi-variable speed/pitch combined with OptiSlip® [3]).

Manufacturer	Concept	Power Range
BONUS (Denmark)	✓ CT/CS ✓ CT/AS	✓ 600 kW ✓ 1 – 2.3 MW
DEWIND (UK/Germany)	✓ VTDD	✓ 600 kW – 2 MW
ECOTECNICA (Spain)	✓ CT/CS ✓ VTDD	✓ 750 – 1300 kW ✓ 1670 kW
ENERCON (Germany)	✓ VTDD	✓ 300 kW – 4.5 MW
GE WIND ENERGY (USA/Germany)	✓ CT/CS ✓ VTDD	✓ 600 kW ✓ 900 kW – 3.6 MW
JEUMONT (France)	✓ VTDD	✓ 750 kW – 1.5 MW
MADE (Spain)	✓ CT/CS ✓ VTSGP	✓ 600 kW – 1.3 MW ✓ 2 MW
NEG MICON (Denmark)	✓ CT/CS ✓ CT/AS ✓ VTDD	✓ 600 kW – 1.5 MW ✓ 1.5 – 2 MW ✓ 2.75 – 4.2 MW
NORDEX (Germany)	✓ CT/CS ✓ VTDD	✓ 600 kW – 1.3 MW ✓ 1.5 – 2.5 MW
VESTAS (Denmark)	✓ SVT/OSP ✓ VTDD	✓ 660 kW – 2.75 MW ✓ 850 kW – 3 MW

Moreover, there is considerable growth potential for wind power. Much of the generating capacity is placed offshore, where higher wind speeds mean higher energy production. For that purpose, ABB developed a new wind power system called Windformer. WECS with Windformer have a high output of typically 3 to 5 MW. The Windformer generator has a variable-speed rotor with permanent magnets and is connected directly to the turbine. The voltage (over 20 kV) produced by the generator is converted to DC by means of diodes. The WECS are connected in groups, the power being transmitted by cable to a network station with inverter, linked directly to the utility grid.



Fig. 13. Largest wind turbine (currently): Enercon E-112 with a rotor diameter of 112 m and a nominal power of 4.5 MW.

The Windformer concept includes a cable-wound generator, directly connected to the turbine. It does not have a gearbox thereby reducing both losses and maintenance (Fig. 14) [37].

VI. SUMMARY

This paper has reviewed the state of art of wind energy conversion systems. The emphasis has been put on generator topologies. Indeed, it has been described the strength and the weakness of the most frequently studied (available literature) and used (industrial cases) wind turbine generators that are: induction generators, doubly-fed induction generators and synchronous generators. Moreover, attempts have been made to highlight current trends and industrial alternative issues.

REFERENCES

- [1] BTM Consults Aps, International Wind Energy Development – World Market Update 2000. ISBN 87-987788-0-3, Ringkøbing, Denmark, 2001.
- [2] B. Multon et al., “Aérogénérateurs électriques,” *Techniques de l'Ingénieur*, Traités de Génie Electrique (in French), D 3 960, Novembre 2004.
- [3] L.H. Hansen et al., “Generators and power electronics technology for wind turbines,” in *Proceedings of IEEE IECON'01*, vol. 3, pp. 2000-2005, Denver (USA), November-December 2001.
- [4] T. Ackermann et al., “Wind energy technology and current status: A review,” *Renewable and Sustainable Energy Reviews*, vol. 4, pp. 315-374, 2000.
- [5] R.W. Thresher et al., “Trends in the evolution of wind turbine generator configurations and systems,” *Int. J. Wind Energy*, vol. 1, n°1, pp. 70–86, April 1998.
- [6] M.R. Dubois et al., “Comparison of generator topologies for direct-drive wind turbines,” in *Proceedings of NORPIE'00*, pp. 22-26, Aalborg (Denmark), June 2000.
- [7] E. Bossanyi, *Wind Energy Handbook*. New York: Wiley, 2000.

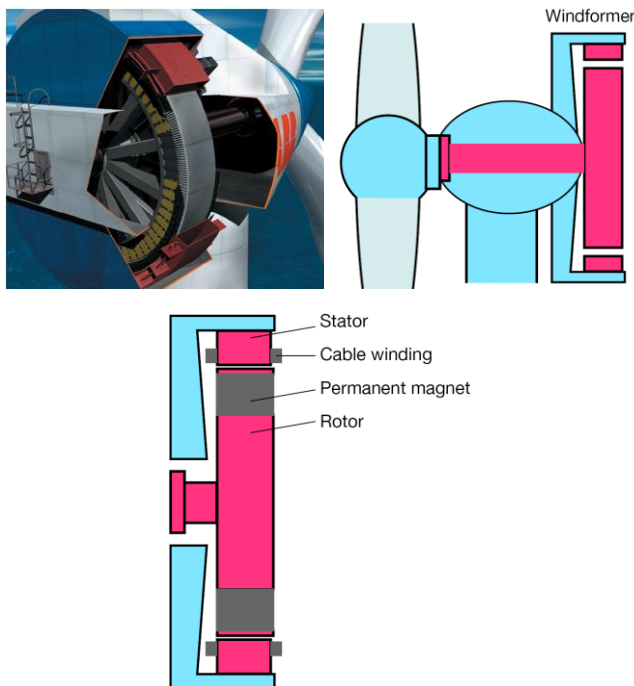

Fig. 14. ABB Windformer concept [37].

- [8] P. Carlin et al., “The History and state of the art of variable-speed wind turbine technology,” *Int. J. Wind Energy*, vol. 6, n°2, pp. 129–159, April-June 2003.
- [9] P. Carlin et al., “History and state of the art of variable-speed wind turbine technology,” *NREL Technical Report*, TP-500-28607, 2001.
- [10] A. Grauers et al., “Efficiency of three wind energy generator systems,” *IEEE Trans. Energy Conversion*, vol. 11, n°3, pp. 650-657, September 1996.
- [11] L.L. Freris, *Wind Energy Conversion System*. London: Prentice Hall, 1990.
- [12] S. Heier, *Grid Integration of Wind Energy Conversion Systems*. New York: Wiley, 1998.
- [13] B. Blaabjerg et al., “Power electronics as efficient interface in dispersed power generation systems,” *IEEE Trans. Power Electronics*, vol. 19, n°5, pp. 1184-1194, September 2004.
- [14] H. Polinder et al., “Basic operation principles and electrical conversion systems of wind turbines,” in *Proceedings of NORPIE'04*, Paper #069, Trondheim (Norway), June 2004.
- [15] P. Thøgersen et al., “Adjustable speed drives in the next decade. Future steps in industry and academia,” *Electric Power Components & Systems*, vol. 32, n°1, pp. 13-31, January 2004.
- [16] E. Koutroulis et al., “Design of a maximum power tracking system for wind-energy-conversion applications,” *IEEE Trans. Industrial Electronics*, vol.53, n°2, pp. 486-494, April 2006.
- [17] J.A. Baroudi et al., “A review of power converter topologies for wind generators,” in *Proceedings of IEEE IEMDC'05*, pp. 458-465, San Antonio (USA), May 2005.
- [18] B. Blaabjerg et al., “Power electronics as an enabling technology for renewable energy integration,” *J. Power Electronics*, vol. 3, n°2, pp. 81-89, April 2003.
- [19] H. Polinder et al., “Generator systems for wind turbines,” in *Proceedings PCIM'03*, 6 pp, Nuremberg, May 2003.
- [20] I. Boldea, “Control of electric generators,” in *Proceedings of IEEE IECON'03*, vol. 1, pp. 972-980, Roanoke (USA), November 2003.
- [21] L.H. Hansen et al., “Conceptual survey of generators and power electronics for wind turbines,” *Report R-1205*, Risø National Laboratory, Denmark, 2001.
- [22] C. Nicolas et al., “Guidelines for the design and control of electrical generator systems for new grid connected wind turbine generators,” in *Proceedings of IEEE IECON'02*, vol. 4, pp. 3317-3325, Seville (Spain), November 2002.
- [23] M.A. Khan et al., “On adapting a small pm wind generator for a multiblade, high solidity wind turbine,” *IEEE Trans. Energy Conversions*, vol. 20, n°3, pp. 685-692, September 2005.
- [24] J.R. Bumby et al., “Axial-flux permanent-magnet air-cored generator for small-scale wind turbines,” *IEE Proc. Electric Power Applications*, vol. 152, n°5, pp. 1065-1075, September 2005.
- [25] G.K. Singh, “Self-excited induction generator research – A survey,” *Electric Power Systems Research*, vol. 69, pp. 107-114, 2004.
- [26] R.C. Bansal et al., “Bibliography on the application of induction generators in nonconventional energy systems,” *IEEE Trans. Energy Conversion*, vol. 18, n°3, pp. 433-439, September 2003.
- [27] P.K.S. Khan et al., “Three-phase induction generators: a discussion on performance,” *Electric Machines & Power Systems*, vol. 27, n°8, pp. 813–832, August 1999.
- [28] M. Ermis et al., “Various induction generator schemes for wind-electricity generation,” *Electric Power Systems Research*, vol. 23, n°1, pp. 71–83, 1992.
- [29] S. Muller et al., “Doubly fed induction generator systems for wind turbines e,” *IEEE Industry Applications Magazine*, vol. 8, n°3, pp. 26-33, May-June 2002.
- [30] R. Datta et al., “Variable-speed wind power generation using doubly fed wound rotor induction machine – A comparison with alternative scheme,” *IEEE Trans. Energy Conversion*, vol. 17, n°3, pp. 414-421, September 2002.
- [31] L. Holdsworth et al., “Comparison of fixed speed and doubly-fed induction wind turbines during power system disturbances,” *IEE Proc. Generation, Transmission and Distribution*, vol. 150, n°3, pp. 343-352, May 2003.
- [32] S. Grabic et al., “A comparison and trade-offs between induction generator control options for variable speed wind turbine applications,”

in *Proceedings of IEEE ICIT'04*, vol. 1, pp. 564-568, Hammamet (Tunisia), December 2004.

- [33] P. Mutschler et al., "Comparison of wind turbines regarding their energy generation," in *Proceedings of IEEE PESC'02*, vol. 1, pp. 6-11, Cairns (Australia), June 2002.
- [34] R. Hoffmann et al., "The influence of control strategies on the energy capture of wind turbines," in *Proceedings of IEEE IAS'02*, vol. 2, pp. 886-893, Rome (Italy), October 2000.
- [35] M. Orabi et al., "Efficient performances of induction generator for wind energy," in *Proceedings of IEEE IECON'04*, vol. 1, pp. 838-843, Busan (Korea), November 2004.
- [36] J.G. Slootweg et al., "Inside wind turbines - Fixed vs. variable speed", *Renewable Energy World*, pp. 30 -40, 2003.
- [37] M. Dahlgren et al., "Windformer", *ABB Review*, vol. 3, pp. 31 -37, 2000.



Yacine Amirat was born in Annaba, Algeria, in 1970. He received the B.Sc. and M.Sc. degrees both in Electrical Engineering, from the University of Annaba, Algeria, in 1994 and 1997 respectively.

He is a Lecturer at the Electrical Engineering Department of the University of Annaba, Algeria.

He is currently pursuing Ph.D. studies on wind power control. His main research interests include analysis, design, and control of electric machines, and renewable energies.



Mohamed El Hachemi Benbouzid (S'92-M'95-SM'98) was born in Batna, Algeria, in 1968. He received the B.Sc. degree in electrical engineering from the University of Batna, Batna, Algeria, in 1990, the M.Sc. and Ph.D. degrees in electrical and computer engineering from the National Polytechnic Institute of Grenoble, Grenoble, France, in 1991 and 1994, respectively, and the Habilitation à Diriger des Recherches degree from the University of Picardie "Jules Verne," Amiens, France, in 2000.

After receiving the Ph.D. degree, he joined the Professional Institute of Amiens, University of Picardie "Jules Verne," where he was an Associate Professor of electrical and computer engineering. In September 2004, he joined the University Institute of Technology (IUT) of Brest, University of Western Brittany, Brest, France, as a Professor of electrical engineering. His main research interests and experience include analysis, design, and control of electric machines, variable-speed drives for traction and propulsion applications, and fault diagnosis of electric machines.

Prof. Benbouzid is a Senior Member of the IEEE Power Engineering, Industrial Electronics, Industry Applications, Power Electronics, and Vehicular Technology Societies. He is an Associate Editor of the IEEE TRANSACTIONS ON ENERGY CONVERSION, the IEEE TRANSACTIONS ON INDUSTRIAL ELECTRONICS, the IEEE TRANSACTIONS ON VEHICULAR TECHNOLOGY, and the IEEE/ASME TRANSACTIONS ON MECHATRONICS.



Bachir Bensaker was born in was born in Roknia, Algeria, in 1954. He received the B.Sc. degree in Electronics Engineering from the University of Science and Technology of Oran, Oran, Algeria, in 1979. From 1979 to 1983, he was a Teaching Assistant with the Department of Electronics Engineering, University of Annaba, Annaba, Algeria. He received the M.Sc. degree and the PhD degree in Instrumentation and Control from the University of Le Havre, Le Havre, France, in 1985 and 1988 respectively. Since 1988, he has been with the Department Electronics Engineering, University of Annaba, Annaba, Algeria, where, since 2004, he has been a Professor. From 1990 to 1998, he has been an Associate Professor with the Industrial Engineering Education Centre (CIFI).

Since 1991, he has been an IFAC Affiliate. His current research interests are focused on nonlinear modeling, condition monitoring, fault detection and diagnostics of electrical machines.



René Wamkeue (S'95-M'98) received his Ph.D. in Electrical Engineering from Ecole Polytechnique de Montréal, Montréal, Canada in 1998. Currently, he is Professor of Electrical Engineering at the University of Québec in Abitibi-Témiscamingue, Rouyn-Noranda, Québec, Canada, where he has been since 1998. He is also an Associate Professor of Electrical Engineering at the University of Laval, Québec City and at the University of Québec at Chicoutimi, Québec, Canada.

His research interests include control, power electronics, modeling and identification of electric machines, power system co-generation with induction generators and wind energy systems. Prof. Wamkeue is a member of the IEEE-PES Electric Machine Committee and the current secretary of Working Group 7 for revision of IEEE Std-115.