



HAL
open science

Dynamic strategy based fast decomposed GA coordinated with FACTS devices to enhance the optimal power flow

Belkacem Mahdad, Tarek Bouktir, Kamel Srairi, Mohamed Benbouzid

► **To cite this version:**

Belkacem Mahdad, Tarek Bouktir, Kamel Srairi, Mohamed Benbouzid. Dynamic strategy based fast decomposed GA coordinated with FACTS devices to enhance the optimal power flow. *Energy Conversion and Management*, 2010, 51 (7), pp.1370-1380. 10.1016/j.enconman.2009.12.018. hal-00525418

HAL Id: hal-00525418

<https://hal.science/hal-00525418>

Submitted on 14 Oct 2010

HAL is a multi-disciplinary open access archive for the deposit and dissemination of scientific research documents, whether they are published or not. The documents may come from teaching and research institutions in France or abroad, or from public or private research centers.

L'archive ouverte pluridisciplinaire **HAL**, est destinée au dépôt et à la diffusion de documents scientifiques de niveau recherche, publiés ou non, émanant des établissements d'enseignement et de recherche français ou étrangers, des laboratoires publics ou privés.

Dynamic Strategy Based Fast Decomposed GA Coordinated with FACTS devices to enhance the Optimal Power Flow

Belkacem Mahdad¹, Tarek Bouktir², Kamel Srairi¹ and Mohamed Benbouzid³

¹University of Biskra / Department of Electrical Engineering, Biskra (07000), Algeria

²Oum El Bouaghi / Department of Electrical Engineering, Oum El Bouaghi, 04000, Algeria

³University of Brest, EA 4325 LBMS, Rue de Kergoat, CS 93837, 29238 Brest Cedex 03, France

Abstract—Under critical situation the main preoccupation of expert engineers is to assure power system security and to deliver power to the consumer within the desired index power quality. The total generation cost taken as a secondary strategy. This paper presents an efficient decomposed GA to enhance the solution of the Optimal Power Flow (OPF) with non-smooth cost function and under severe loading conditions. At the decomposed stage the length of the original chromosome is reduced successively and adapted to the topology of the new partition. Two sub problems are proposed to coordinate the OPF problem under different loading conditions: the first sub problem related to the active power planning under different loading factor to minimize the total fuel cost, and the second sub problem is a reactive power planning designed based in practical rules to make fine corrections to the voltage deviation and reactive power violation using a specified number of shunt dynamic compensators named Static Var Compensators (SVC). To validate the robustness of the proposed approach, the proposed algorithm tested on IEEE 30-Bus, 26-Bus and IEEE 118-Bus under different loading conditions and compared with global optimization methods (GA, EGA, FGA, PSO, MTS, MDE and ACO) and with two robust simulation packages: PSAT and MATPOWER. The results show that the proposed approach can converge to the near solution and obtain a competitive solution at critical situation and with a reasonable time.

Key Words— Decomposed Network, Parallel Genetic Algorithm, System loadability, FACTS, SVC, Optimal power flow, System security, Planning and control.

I. INTRODUCTION

THE main objective of an OPF strategy is to determine the optimal operating state of a power system by optimizing a particular objective while satisfying certain specified physical and operating constraints. In its most general formulation, the OPF is a nonlinear, nonconvex, large-scale, static optimization problem with both continuous and discrete control variables. It becomes even more complex when flexible ac transmission systems (FACTS) devices are taken into consideration as control variables [1-2].

The global optimization techniques known as genetic algorithms (GA) [3], simulated annealing (SA) [4], tabu search (TS) [5], Evolutionary programming (EP) [6], Particle swarm optimization (PSO) [7], Differential evolution (DE) [8], which are the forms of probabilistic heuristic algorithm have been successfully used to overcome the non-convexity problems of the constrained economic dispatch (ED).

The literature on the application of the global optimization in the OPF problem is vast and [9] represents the major contributions in this area. In [3] authors present an enhanced genetic algorithm (EGA) for the solution of the OPF problem with both continuous and discrete control variables. The continuous control variables modeled are unit active power outputs and generator-bus voltage magnitudes, while the discrete ones are transformer-tap settings and switchable shunt devices. In [10] the authors proposed a simple combined genetic algorithm and evolutionary programming applied to the OPF problem in large-scale power systems, to accelerate the processes of the optimization, the controllable variables are decomposed to active and passive constraints. The active constraints are taken to minimize the fuel cost function; the passive constraints are taken and integrated to an efficient power flow problem to make corrections to the active power of the slack bus. Authors in [11] present a modified differential evolution (MDE) to solve the optimal power flow (OPF) with non-smooth cost function, in [12] authors present a novel string structure for solving the economic dispatch through genetic algorithm (GA). To accelerate the search process Authors in [13] proposed a multiple tabu search algorithm (MTS) to solve the dynamic economic dispatch (ED) problem with generator constraints, simulation results prove that this approach is able to reduce the computational time compared to the conventional approaches.

The power system academic has made great efforts to provide to scientific community simulation tools that cover different aspects of power systems analysis. Some robust examples of these simulation packages are Power Systems Analysis Toolbox (PSAT) developed by Federico Milano [14] and Matpower developed by Ray D. Zimmerman et al. [15].

In general, conventional methods face problems in yielding optimal solution due to nonlinear and nonconvex characteristic of the generating units. The true global optimum of the problem could not be reached easily. The GA method has usually better efficiency because the GA has parallel search techniques. Due to its high potential for global optimization, GA has received great attention in solving optimal power flow (OPF) problems. The main disadvantage of GAs is the high CPU time execution and the qualities of the solution deteriorate with practical large-scale optimal power flow (OPF) problems [16].

To overcome the drawbacks of the conventional methods related to the form of the cost function, and to reduce the computational time related to the large space search required by GA, this paper presents an efficient parallel GA (EPGA) for the solution of large-scale OPF with consideration shunt FACTS devices under severe loading conditions. The length of the original chromosome is reduced successively based on the decomposition level and adapted with the topology of the new partition. Partial decomposed active power demand added as a new variable and searched within the active power generation variables of the new decomposed chromosome. The proposed strategy of the OPF problem is decomposed in two sub-problems, the first sub-problem related to active power planning to minimize the fuel cost function, and the second sub-problem designed to make corrections to the voltage deviation and reactive power violation based in an efficient reactive power planning using multi Static Var Compensator (SVC).

Simulation results demonstrate that the proposed decomposed GA approach is superior to the standard GA and appears to be fast providing competitive results under critical situation compared to the conventional and global optimization methods reported in the literature recently.

II. OPTIMAL POWER FLOW FORMULATION

The active power planning problem is considered as a general minimization problem with constraints, and can be written in the following form:

$$\text{Min} \quad f(x, u) \quad (1)$$

$$\text{S. t} \quad : g(x, u) = 0 \quad (2)$$

$$h(x, u) \leq 0 \quad (3)$$

$$x = [\delta \quad V_L]^T \quad (4)$$

$$u = [P_G \quad V_G \quad t \quad B_{svc}]^T \quad (5)$$

$f(x, u)$ is the objective function, $g(x, u)$ and $h(x, u)$ are respectively the set of equality and inequality constraints. x is the state variables and u is the vector of control variables. The control variables are generator active and reactive power outputs, bus voltages, shunt capacitors/reactors and transformers tap-setting. The state variables are voltage and angle of load buses. For optimal active power dispatch, the objective function f is total generation cost as expressed follows:

$$\text{Min} \quad f = \sum_{i=1}^{N_g} (a_i + b_i P_{gi} + c_i P_{gi}^2) \quad (6)$$

where N_g is the number of thermal units, P_{gi} is the active power generation at unit i and a_i , b_i and c_i are the cost coefficients of the i^{th} generator.

The equality constraints $g(x)$ are the power flow equations.

The inequality constraints $h(x)$ reflect the limits on physical devices in the power system as well as the limits created to ensure system security.

A. Non-smooth cost function with prohibited operation zones

The prohibited operating zones in the input-output performance curve for a typical thermal unit can be due to robustness in the shaft bearings caused by the operation of steam valves or to faults in the machines themselves or in the associated auxiliary, equipment such as boilers; feed pumps etc. [3-4]. In practice

when adjusting the operation output of a unit one must avoid the operation in the prohibited zones. Thus the input-output performance curve for a typical thermal unit can be represented as shown in Fig 1.

$$P_i \in \begin{cases} P_i^{\min} \leq P_i \leq P_{i,1}^1 \\ P_{i,k-1}^u \leq P_i \leq P_{i,k}^1, & k = 2, \dots, z_i \\ P_{i,z_i}^u \leq P_i \leq P_i^{\max} \end{cases} \quad (7)$$

z_i is the number of prohibited zones of unit i ;

k is the index of prohibited zones of a unit i ;

$P_{i,k}^{1/u}$ is the lower/upper bounds of the k^{th} prohibited zone of unit i ;

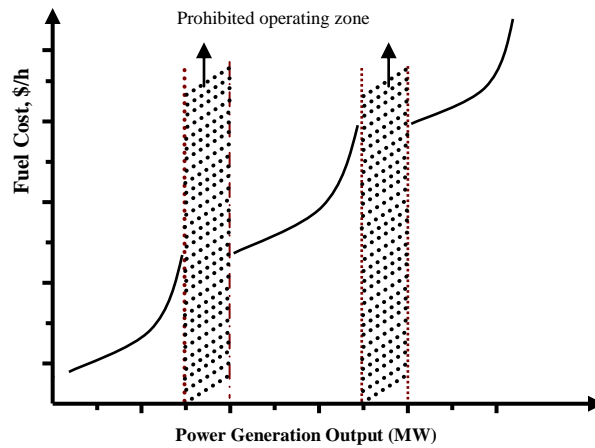

Fig 1 Input-Output curve with prohibited operating zones

III. SHUNT FACTS MODELLING

A. Static VAR Compensator (SVC)

The steady-state model proposed in [17] is used here to incorporate the SVC on power flow problems. This model is based on representing the controller as a variable impedance, assuming an SVC configuration with a fixed capacitor (FC) and Thyristor-controlled reactor (TCR) as depicted in Figure 2.

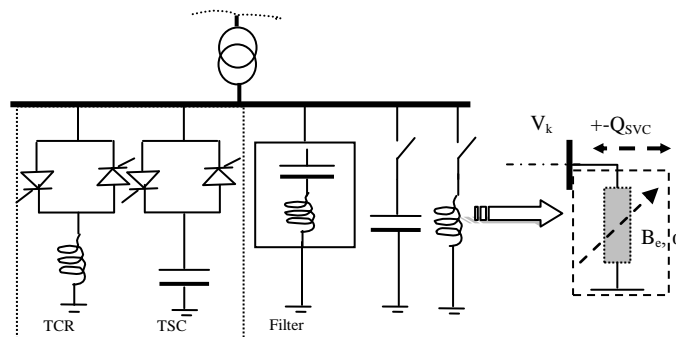

Fig. 2. SVC steady-state circuit representation

$$V = V_{ref} + X_{sl} I \quad (8)$$

X_{sl} are in the range of 0.02 to 0.05 p.u. with respect to the SVC base. The slope is needed to avoid hitting limits. At the voltage limits the SVC is transformed into a fixed reactance. The total equivalent impedance X_e of SVC may be represented by

$$X_e = X_c \frac{\pi / k_x}{\sin 2\alpha - 2\alpha + \pi(2 - 1/k_x)} \quad (9)$$

where $k_x = x_c / x_L$

IV. STRATEGY OF THE EFFICIENT PARALLEL GA FOR OPF

A. Principle of the Proposed Approach

Parallel execution of various SGAs is called PGA (Parallel Genetic Algorithm). Parallel Genetic Algorithms (PGAs) have been developed to reduce the large execution times that are associated with simple genetic algorithms for finding near-optimal solutions in large search spaces. They have also been used to solve larger problems and to find better solutions. PGAs can easily be implemented on networks of heterogeneous computers or on parallel mainframes. The way in which GAs can be parallelized depends upon the following elements [18]:

- How fitness is evaluated.
- How selection is applied locally or globally.
- How genetic operators (crossover and mutation are used and applied)
- If single or multiple subpopulations are used.
- If multiple populations are used how individuals are exchanged.
- How to coordinate between different subpopulations to save the proprieties of the original chromosome.

In the proposed approach the subpopulations created are dependent, efficient load flow used as a simple tool for flexible coordination to test the performance of the new subpopulations generated.

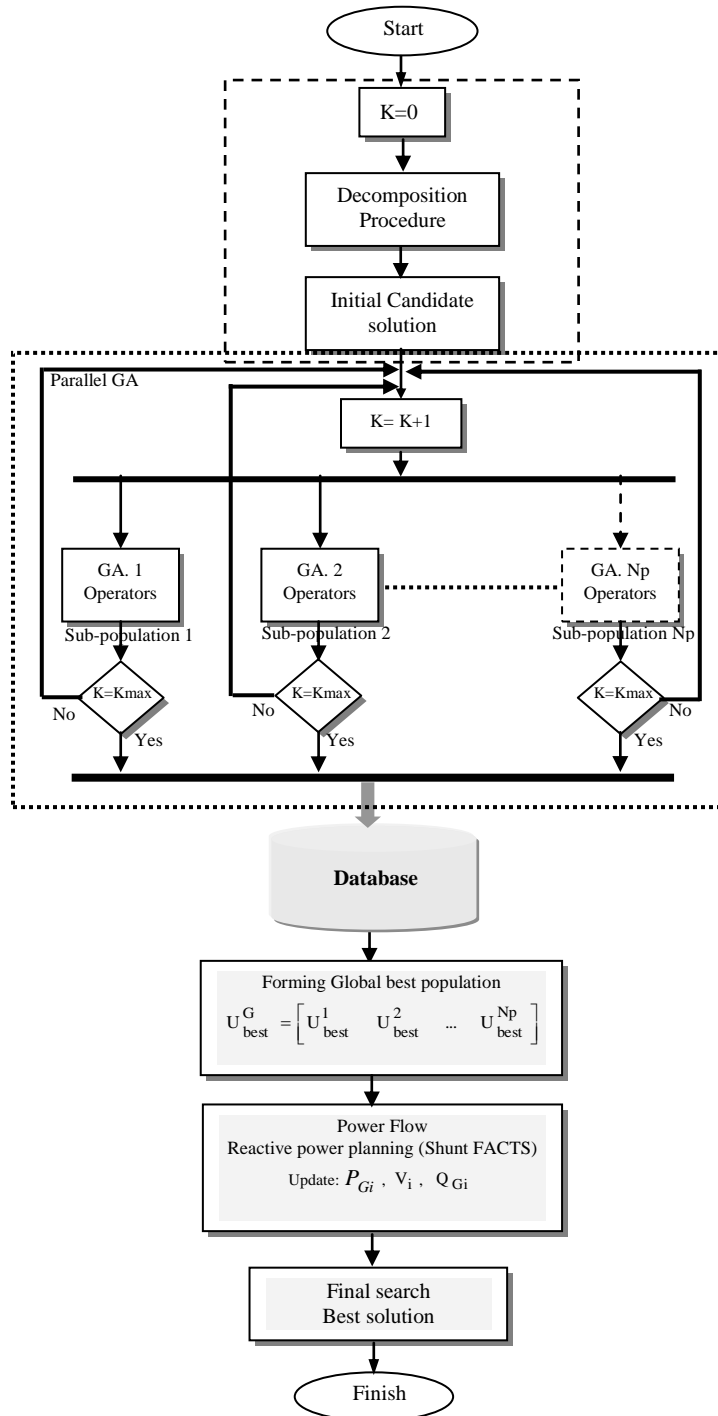

Fig 3 Flowchart of the proposed EPGA approach-based OPF.

Fig. 3 presents the principle of the efficient parallel GA proposed approach for active power planning coordinated with reactive power planning to adjust the voltage source and reactive power compensation within their specified constraints limits to reduce voltage deviation and the thermal transmission line.

In this study the controllable FACTS devices considered include shunt Compensators (SVC).

The proposed algorithm decomposes the solution of such a modified OPF problem into two linked sub problems. The first sub problem is an active power generation planning solved by the proposed Efficient Genetic Algorithm, and the second sub problem is a reactive power planning [18] to make fine adjustments on the optimum values obtained from the EPGA. This will provide updated voltages, angles and point out generators having exceeded reactive limits.

B. Decomposition Mechanism

Problem decomposition is an important task for large-scale OPF problem, which needs answers to the following two technical questions.

- 1- How many efficient partitions needed?
- 2- Where to practice and generate the efficient inter-independent sub-systems?

The decomposition procedure decomposes a problem into several interacting sub-problem that can be solved with reduced sub-populations, and coordinate the solution processes of these sub-problems to achieve the solution of the whole problem.

C. Justification for using Efficient Parallel Continuous GA

1) Standard Genetic Algorithm

GA is a global search technique based on mechanics of natural selection and genetics. It is a general-purpose optimization algorithm that is distinguished from conventional optimization techniques by the use of concepts of population genetics to guide the optimization search. Instead of point-to-point search, GA searches from population to population. The advantages of GA over traditional techniques are [19]:

- i) It needs only rough information of the objective function and places no restriction such as differentiability and convexity on the objective function.
- ii) The method works with a set of solutions from one generation to the next, and not a single solution, thus making it less likely to converge on local minima.
- iii) The solutions developed are randomly based on the probability rate of the genetic operators such as mutation and crossover; the initial solutions thus would not dictate the search direction of GA.

2) *Continuous GA Applied to the OPF Problem*

The binary GA has its precision limited by the binary representation of variables; using floating point numbers instead easily allows representation to the machine precision. This continuous GA also has the advantage of requiring less storage than the binary GA because a single floating-point number represents the variable instead of N_{bits} integers. The continuous GA is inherently faster than the binary GA, because the chromosomes do not have to be decoded prior to the evaluation of the cost function [19]. Fig. 4 shows the chromosome structure within the approach proposed.

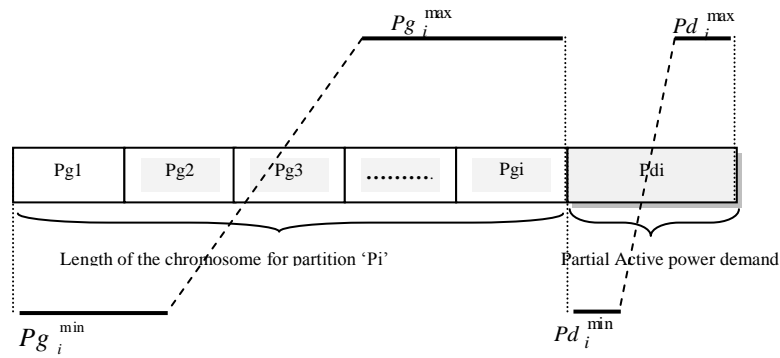

Fig 4 Chromosome structure.

a) *Algorithm of the Proposed Approach*

1. *Initialization based in Decomposition Procedure*

The main idea of the proposed approach is to optimize the active power demand for each partitioned network to minimize the total fuel cost. An initial candidate solution generated for the global N population size.

1-For each decomposition level estimate the initial active power demand:

For NP=2 Do

$$Pd\ 1 = \sum_{i=1}^{M\ 1} P_{Gi} \quad (10)$$

$$Pd\ 2 = \sum_{i=1}^{M\ 2} P_{Gi} = PD - Pd\ 1 \quad (11)$$

Where NP the number of partition

$Pd\ 1$: the active power demand for the first initial partition.

$Pd\ 2$: the active power demand for the second initial partition.

PD : the total active power demand for the original network.

The following equilibrium equation should be verified for each decomposed level:

For level 1:

$$Pd_1 + Pd_2 = PD + Ploss \quad (12)$$

2-Fitness Evaluation based Load Flow

For all sub-systems generated perform a load flow calculation to evaluate the proposed fitness function. A candidate solution formed by all sub-systems is better if its fitness is higher.

$$f_i = 1 / (F_{\cos t} + \omega_l F_{li} + \omega_v F_{Vi}) \quad (13)$$

$$F_{Vi} = \sum_{j=1}^{nPQ} \left(\left| V_{PQij} - V_{PQij}^{\lim} \right| \right) / \left(\left| V_{PQij}^{\max} - V_{PQij}^{\min} \right| \right) \quad (14)$$

where f_i is fitness function for sub- systems decomposed at level i.

F_{li} denotes the per unit power loss generated by sub-systems at level i; $F_{\cos t}$ denotes the total cost of the active power planning related to the decomposition level i; F_{Vi} denotes the sum of the normalized violations of voltages related to the sub-systems at level i.

3-Consequently under this concept, the final value of active power demand should satisfy the following equations.

$$\sum_{i=1}^{N_g} (Pg_i) = \sum_{i=1}^{part_i} (Pd_i) + ploss \quad (15)$$

$$Pg_i^{\min} \leq Pg_i \leq Pg_i^{\max} \quad (16)$$

3. Final Search Mechanism

- All the sub-systems are collected to form the original network, global data base generated based on the best results U_{best}^{Parti} of partition 'i' found from all sub-populations.
- The final solution U_{best}^{Global} is found out after reactive power planning procedure to adjust the reactive power generation limits, and voltage deviation, the final optimal cost is modified to compensate the reactive constraints violations. Fig. 5 illustrates the mechanism of search partitioning; Fig. 6 shows an example of tree network decomposition.

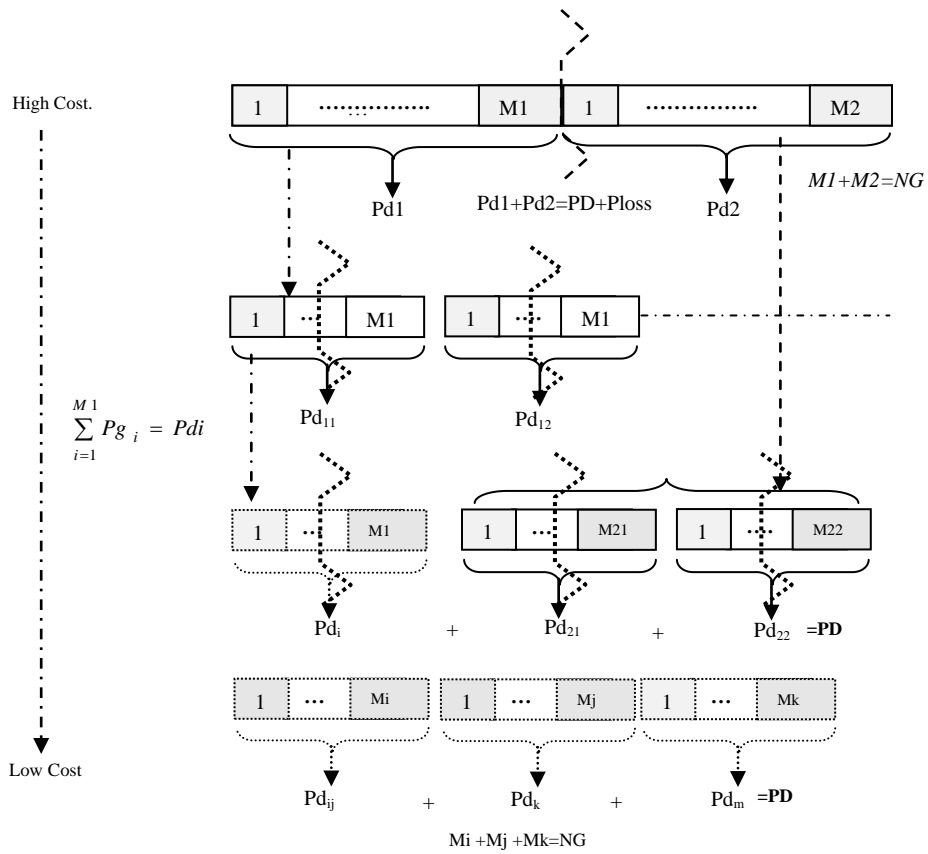

Fig 5. Mechanism of search partitioning.

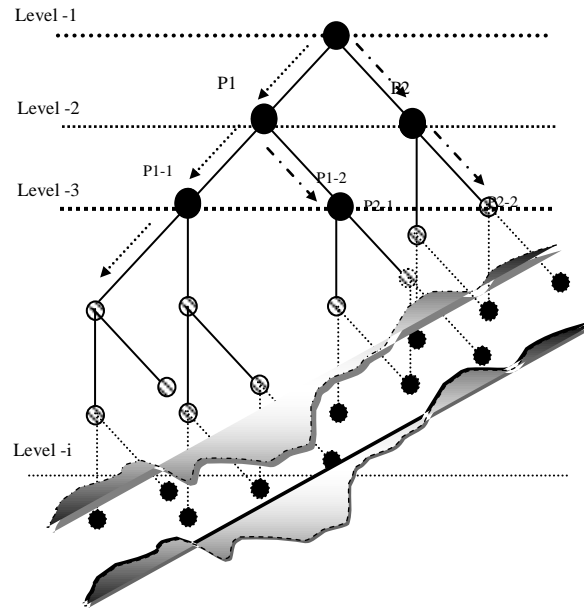

Fig 6 Sample of network with tree decomposition.

V. APPLICATION STUDY

The proposed algorithm is developed in the Matlab programming language using 6.5 version. The proposed DGA is tested using modified IEEE 30-bus system. The test examples have been run on a 2.6-Ghz Pentium-IV PC. The generators data and cost coefficients are taken from [19].

A. Case Studies on the IEEE 30-Bus System

1) Comparison with Global Optimization

The first test is the IEEE 30-bus, 41-branch system, for the voltage constraint the lower and upper limits are 0.9 p.u and 1.1 p.u., respectively. The GA population size is taken equal 30, the maximum number of generation is 100, and crossover and mutation are applied with initial probability 0.9 and 0.01 respectively. For the purpose of verifying the efficiency of the proposed approach, we made a comparison of our algorithm with others competing OPF algorithm. In [19], they presented a standard GA, in [3] the authors presented an enhanced GA, and then in [20], they proposed an Improved evolutionary programming (IEP). In [21] they presented an optimal power flow solution using GA-Fuzzy system approach (FGA), and in [11] a modified differential evolution is proposed (MDE). The operating cost in our proposed approach is 800.8336 and the power loss is 8.92 which are better than the others methods reported in the literature. Results in Table I show clearly that the proposed approach gives better results. Table II shows the best solution of shunt compensation obtained at the standard load demand ($P_d=283.4$ MW) using reactive power planning.

TABLE I
RESULTS OF THE MINIMUM COST AND POWER GENERATION COMPARED WITH:
SGA, EGA, IEP, FGA AND MDE FOR IEEE 30-BUS

Variables	Our Approach EPGA			SGA[19]	EGA[3]	IEP[20]	FGA[21]	MDE [11]
	NP=1	NP=2	NP=3					
				<i>Global Optimization Methods</i>				
P1(MW)	180.12	175.12	174.63	179.367	176.20	176.2358	175.137	175.974
P2(MW)	44.18	48.18	47.70	44.24	48.75	49.0093	50.353	48.884
P5(MW)	19.64	20.12	21.64	24.61	21.44	21.5023	21.451	21.510
P8(MW)	20.96	22.70	20.24	19.90	21.95	21.8115	21.176	22.240
P11(MW)	14.90	12.96	15.04	10.71	12.42	12.3387	12.667	12.251
P13(MW)	12.72	13.24	12.98	14.09	12.02	12.0129	12.11	12.000
Q1(Mvar)	-4.50	-2.11	-2.03	-3.156	-	-	-6.562	-
Q2(Mvar)	30.71	32.57	32.42	42.543	-	-	22.356	-
Q5(Mvar)	22.59	24.31	23.67	26.292	-	-	30.372	-
Q8(Mvar)	37.85	27.82	28.22	22.768	-	-	18.89	-
Q11(Mvar)	-2.52	0.490	0.48	29.923	-	-	21.737	-
Q13(Mvar)	-13.08	-11.43	-11.43	32.346	-	-	22.635	-
θ1(deg)	0.00	0.00	0.00	0.000	-	-	0.00	-
θ2(deg)	-3.448	-3.324	-3.313	-3.674	-	-	-3.608	-
θ5(deg)	-9.858	-9.725	-9.623	-10.14	-	-	-10.509	-
θ8(deg)	-7.638	-7.381	-7.421	-10.00	-	-	-8.154	-
θ11(deg)	-7.507	-7.680	-7.322	-8.851	-	-	-8.783	-
θ13(deg)	-9.102	-8.942	-8.926	-10.13	-	-	-10.228	-
Cost (\$/hr)	801.3445	800.8336	800.9265	803.699	802.06	802.465	802.0003	802.376
Ploss (MW)	9.120	8.920	8.833	9.5177	9.3900		9.494	9.459
Average CPU time (s)		-0.954		-	-	594.08	-	23.07

TABLE II
COMPARATIVE RESULTS OF THE SHUNT REACTIVE POWER COMPENSATION BETWEEN
EPGA AND EGA [7] FOR IEEE 30-BUS

Shunt N°	1	2	3	4	6	7	8	9
Bus N°	10	12	15	17	21	23	24	29
Best Qsvc [pu]	0.1517	0.0781	0.0295	0.0485	0.0602	0.0376	0.0448	0.0245
Best case bsh [pu] [7]	0.05	0.05	0.03	0.05	0.05	0.04	0.05	0.03

The operation costs of the best solutions for the new system composed by two partitions and for the new system composed by three partitions are 800.8336 \$/h and 800.9265, respectively , (0.0929 difference). The differences between the values are not significant compared to the original network without partitioning. This proves that the new subsystems generated conserve the physical proprieties and performances of the original network. Table III shows that the line flows obtained are well under security limits compared to FGA algorithm and ACO algorithm [22].

TABLE III
TRANSMISSION LINE LOADING AFTER OPTIMIZATION COMPARED TO
ACO AND FGA FOR IEEE 30-BUS

Line	EPGA: PD=283.4 MW			ACO [22]	FGA [21]
	Rating (MVA)	From Bus P(MW)	To Bus P(MW)	To Bus P(MW)	To Bus +(P(MW))
1-2	130	113.9200	-7.7300	-119.5488	117.211
1-3	130	60.7100	5.7000	-58.3682	58.3995
2-4	65	32.0600	4.3000	-34.2334	34.0758
3-4	130	56.8600	3.7900	-55.5742	54.5622
2-5	130	62.4200	4.9000	-62.4522	63.7783
2-6	65	43.3000	2.4400	-44.5805	45.3399
4-6	90	49.1700	-8.0100	-49.0123	50.2703
5-7	70	-11.7900	7.2300	11.2939	14.1355
6-7	130	34.9800	0.8800	-34.0939	33.9924
6-8	32	11.8500	-1.3200	-11.0638	13.6882
6-9	65	16.5700	-3.3400	-19.7631	22.4033
6-10	32	12.5400	0.0700	-13.1277	14.6187
9-11	65	-15.0400	-0.0700	10.4330	24.1764
9-10	65	31.6100	-3.8000	-30.1961	32.7929
4-12	65	31.2200	16.7200	-33.1670	30.5889
12-13	65	-12.9800	11.8000	12.1730	24.9376
12-14	32	7.6600	1.0500	-8.0453	7.6911
12-15	32	18.1000	1.4900	-18.1566	17.4525
12-16	32	7.2400	1.3600	-7.4961	6.34027
14-15	16	1.4000	-0.6800	-1.8340	1.2313
16-17	16	3.6900	-0.5400	-3.9715	3.2983
15-18	16	5.8900	1.9700	-6.2224	5.4066
18-19	16	2.6500	1.0000	-3.0140	2.3627
19-20	32	-6.8500	-2.4100	6.5015	8.5117
10-20	32	9.1500	3.3200	-8.7015	11.0315
10-17	32	5.3200	0.8600	-5.0285	9.861616
10-21	32	16.1000	3.9800	-15.8419	18.96153
10-22	32	7.7800	1.7400	-7.6778	9.0741
21-22	32	-1.4800	-0.6100	1.6585	2.0887
15-23	16	5.2100	-0.7000	-5.4613	4.5343
22-24	16	6.2600	1.0400	-5.9593	6.9397
23-24	16	1.9900	1.8800	-2.2388	1.14447
24-25	16	-0.5000	1.1200	0.5027	1.3934
25-26	16	3.5400	2.3600	-3.5000	4.2647
25-27	16	-4.0500	-1.2400	4.0748	5.633
27-28	65	17.3200	2.9500	-17.3814	19.7428
27-29	16	6.1900	-0.2900	-6.1070	6.4154
27-30	16	7.0600	0.8900	-6.9295	7.2897
29-30	16	3.7200	1.3500	-3.6705	3.7542
8-28	32	2.0700	-2.1900	-2.2067	3.3685
6-28	32	15.2900	-0.6800	-15.1747	16.5409
Ploss (MW)		8.8836		9.8520	9.494

2) Comparison with PSAT and MATPOWER OPF Solver

For the purpose of verifying the robustness of the proposed algorithm we made a second comparison with PSAT and MATPOWER packages under severe loading conditions.

In this study the increase in the load is regarded as a parameter which affects the power system to voltage collapse.

$$\begin{cases} P_L = Kld \cdot P_{ol} \\ Q_L = Kld \cdot Q_{ol} \end{cases} \quad (17)$$

Where, P_{ol} and Q_{ol} are the active and reactive base loads, P_L and Q_L are the active and reactive loads at bus L for the current operating point. Kld represents the loading factor.

TABLE IV
RESULTS OF THE MINIMUM COST AND POWER GENERATION COMPARED WITH :
PSAT AND MATPOWER PACKAGE FOR IEEE 30-BUS

Variables	Our Approach EPGA		MATPOWER		PSAT	
	Kld=18%	Kld=32%	Kld=18%	Kld=32%	Kld=18%	Kld=32%
P1(MW)	192.66	199.30	200.00	200.0	200.00	200.0
P2(MW)	58.94	70.60	55.00	69.74	54.9925	69.9368
P5(MW)	23.22	29.08	23.70	28.40	23.6957	28.5135
P8(MW)	33.98	33.66	35.00	35.00	35.00	35.00
P11(MW)	16.60	29.32	17.01	28.03	17.0154	28.2596
P13(MW)	20.40	25.10	15.84	26.47	15.8827	26.7635
Q1(Mvar)	-5.26	-6.18	-13.94	-17.66	-15.6226	-9.4127
Q2(Mvar)	38.07	40.02	37.18	43.69	38.5416	60.4752
Q5(Mvar)	35.25	42.28	36.10	42.62	36.5254	49.5412
Q8(Mvar)	35.95	43.54	47.96	60.00	49.525	50.00
Q11(Mvar)	1.150	2.06	3.680	6.910	4.6425	21.1631
Q13(Mvar)	-11.73	-11.04	-11.68	-2.270	2.3642	19.7389
θ1(deg)	0.00	0.00	0.00	0.00	0.00	0.00
θ2(deg)	-3.684	-3.972	-4.028	-4.022	-4.0412	-4.026
θ5(deg)	-11.218	-12.002	-11.841	-12.518	-11.8475	-12.6009
θ8(deg)	-8.055	-8.588	-8.737	-9.065	-8.7607	-8.7792
θ11(deg)	-11.995	-6.847	8.931	-7.386	-8.9022	-7.0128
θ13(deg)	-9.344	-9.423	-10.642	-9.751	-10.6419	-9.8547
Cost (\$/hr)	993.6802	1159.6	993.98	1160.56	994.1047	1164.1706
Ploss MW	11.390	12.975	12.141	13.556	12.174	14.385

The results including the generation cost, the power losses, reactive power generation, and the angles are shown in Table IV. We can clearly observe that the total cost of generation and power losses are better than the results obtained by PSAT and MATPOWER at both loading factor (kld=18% and kld=32%). For example at loading factor 32% (PD=374.088) the difference in generation cost between our approach and to the two Packages (1159.6 \$/h compared to 1160.56 \$/h and 1164.1706 \$/h) and in real power loss (12.975 MW compared to 13.556 MW and 14.385 MW) obtained from MATPOWER and PSAT respectively. Table V depicts the results of minimum cost, power generation, power losses, reactive power generation, and angles. At loading factor kld=48.5%, the two simulation Package (PSAT and MATPOWER) did not converge. The approach proposed gives acceptable solution, the minimum total cost is 1403.5 \$/h. The security constraints are also checked for voltage magnitudes, angles and branch flows.

Fig. 7 shows that the voltages magnitudes are within the specified security limits. Fig. 8 shows clearly that the transmission lines loading do not exceed their upper limits. Fig. 9 shows the reactive power exchanged between SVC Controllers installed at a specified buses and the network.

TABLE V
RESULTS OF THE MINIMUM COST AND POWER GENERATION COMPARED WITH PSAT AND MATPOWER PACKAGE FOR IEEE 30-BUS

Variables	Loading Factor Kld=48.5%				
	PD=420.85 MW				
	Our Approach	PSAT	MATPOWER		
P1(MW)	199.98	Did not Converge	Did not Converge		
P2(MW)	79.96				
P5(MW)	49.98				
P8(MW)	34.92				
P11(MW)	30.00				
P13(MW)	39.90				
Q1(Mvar)	-5.680				
Q2(Mvar)	41.62				
Q5(Mvar)	45.14				
Q8(Mvar)	53.31				
Q11(Mvar)	2.910				
Q13(Mvar)	-10.33				
θ1(deg)	0.000				
θ2(deg)	-3.761				
θ5(deg)	-11.907				
θ8(deg)	-8.972				
θ11(deg)	-7.228				
θ13(deg)	-8.237				
Cost (\$/hr)	1403.5				
Ploss (MW)	13.8960				

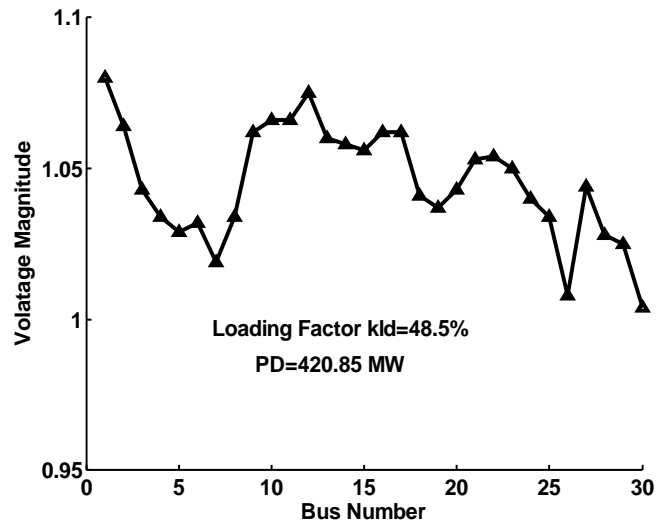

Fig. 7 Voltage profile at loading factor: kld=48.5%

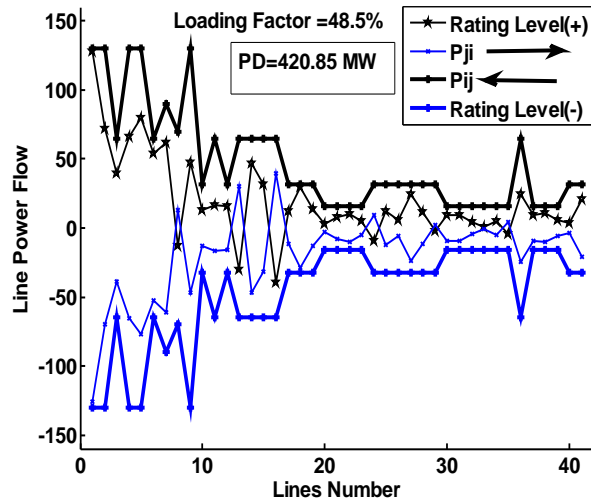

Fig. 8 Lines Power flow at critical loading Factor Kld= 48.5%.

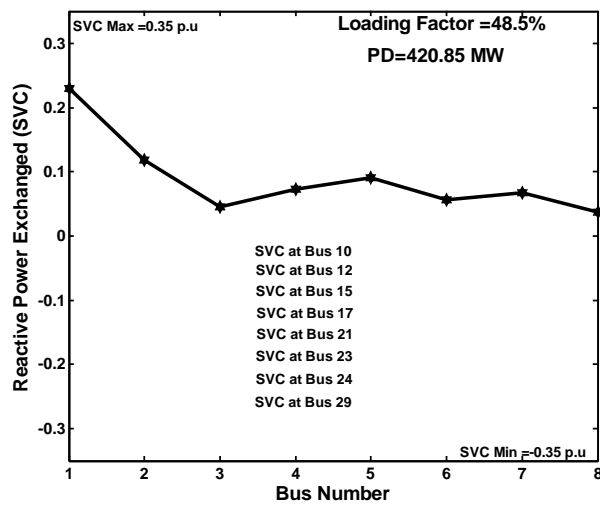

Fig. 9 Reactive power exchanged between SVC Controllers and the Network at loading factor: Kld=48.5%.

B. Case study 2: 26-bus test system with non smooth cost function

This case study consisted of six generation units, 26 buses and 46 transmission lines [23]. All thermal units are within the ramp rate limits and prohibited zones. All data of this test system can be retrieved from [23-24]. In this case, the load demand expected to be determined was PD=1263. The B matrix of the transmission loss coefficient is given by:

$$B_{ij} = 10^{-3} \begin{bmatrix} 1.7 & 1.2 & 0.7 & -0.1 & -0.5 & -0.2 \\ 1.2 & 1.4 & 0.9 & 0.1 & -0.6 & -0.1 \\ 0.7 & 0.9 & 3.1 & 0.0 & -1.0 & -0.6 \\ -0.1 & 0.1 & 0.0 & 0.24 & -0.6 & -0.8 \\ -0.5 & -0.6 & -0.6 & -0.6 & 12.9 & -0.2 \\ -0.2 & -0.1 & -0.6 & -0.8 & -0.2 & 15.0 \end{bmatrix} \quad (18)$$

$$B_{i0} = 10^{-3} \cdot [-0.3908 \quad -0.1297 \quad -0.7047 \quad -0.0591 \quad 0.2161 \quad -0.6635] \quad (19)$$

$$B_{00} = 0.056 \quad (20)$$

Table shows the performance comparison among the proposed algorithms, a particle swarm optimization (PSO) approach [23], a novel string based GA [12], standard genetic algorithm (GA) method [23], multiple tabu search algorithm (MTS) [13], and the simulated annealing (SA) method [13]. The simulation results of the proposed approach outperformed recent optimization methods presented in the literature in terms of solution quality and time convergence.

TABLE VI
RESULTS OF THE MINIMUM COST AND POWER GENERATION COMPARED WITH
GLOBAL OPTIMIZATION METHODS FOR 26-BUS TEST SYSTEM

Generators (MW)		SA[13]	New-string GA [12]	GA [23]	MTS[13]	PSO[23]	Our Approach
P_{g1}	Part1	478.1258	446.7100	474.8066	448.1277	447.4970	448.0451
P_{g2}		163.0249	173.0100	178.6363	172.8082	173.3221	172.0835
P_{g3}	Part2	261.7143	265.0000	262.2089	262.5932	263.4745	264.5932
P_{g4}		125.7665	139.0000	134.2826	136.9605	139.0594	134.9605
P_{g5}	Part3	153.7056	165.2300	151.9039	168.2031	165.4761	170.2452
P_{g6}		90.7965	86.7800	74.1812	87.3304	87.1280	85.2884
Total PG		1276.1339	1275.73	1276.03	1276.0232	1276.01	1275.20
Ploss (MW)		13.1317	12.733	13.0217	13.0205	12.9584	12.2160
Cost[\$/hr]		15461.10	15447.00	15459.00	15450.06	15450.00	15439
CPU time(s)		-	8.36	-	1.29	14.89	1.4380

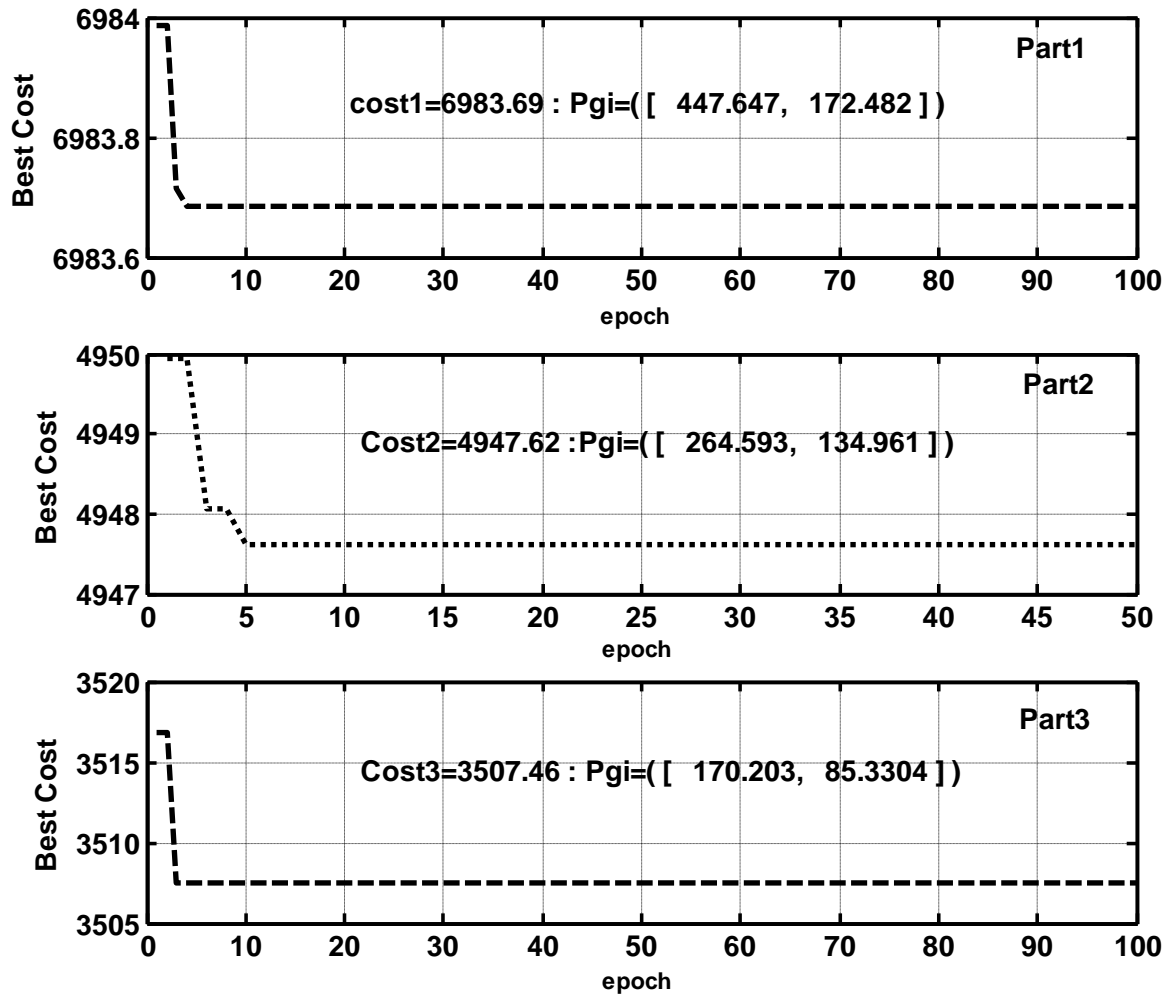

Fig. 10 Convergence characteristic of the three partition network 26-Bus.

The performance of the convergence characteristics for the three partitioned network are shown clearly in Fig. 10. The computational time of the proposed approach is reduced significantly in comparison to the other methods.

C. Case Study 3 on the IEEE 118-Bus

To investigate the robustness of the proposed approach the algorithm was implemented and tested to the standard IEEE 118-bus model system (54 generators, 186 (line + transformer) and 99 loads). The system load is 4242 MW and base MVA is 100 MVA. In this model, there are 54 generators and they are consists of different 18 characteristic generators [19]. The proposed approach is compared to the real Genetic Algorithm proposed in [19]. The results depicted in Table VI show clearly that the proposed approach

gives much better results than the others method. The difference in generation cost between these two studies (6347.2\$/h compared to 8278.9\$/h) and in real power loss (106.788 MW compared to 94.305 MW).

The optimum active powers are all in their secure limits values and are far from the physical constraints limits. The security constraints are also checked for voltage magnitudes and angles. Reactive power planning [11-12] applied in the second step based in practical fuzzy rules. Fig. 11 shows the topology the standard IEEE 118-Bus, Fig. 12 shows that the reactive power generations are on their security limits; Fig. 13 shows the reactive power exchanged between the SVC Compensators installed at critical buses and the network. Fig. 14 demonstrates that the voltage profiles for all buses are enhanced based in reactive power planning subproblem.

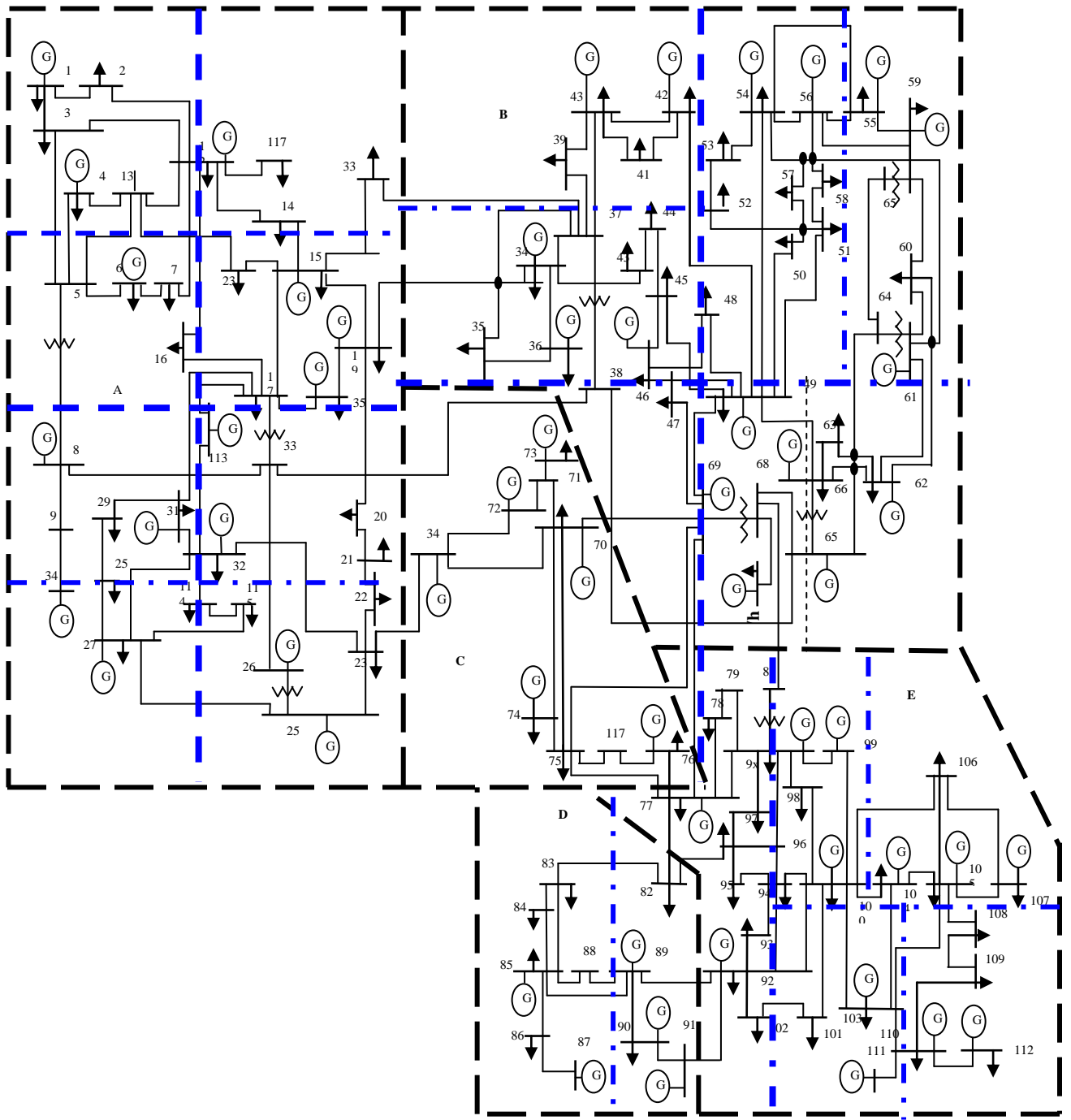

Fig. 11 Topology of the IEEE 118-Bus test system.

TABLE VI
RESULTS OF THE MINIMUM COST AND POWER GENERATION COMPARED WITH GA FOR IEEE 118-BUS

Gen	Type	EPGA	GA [19]	Gen	Type	EPGA	GA [19]
1	#1	10.840	11.99	65	#11	402.60	456.61
4	#1	11.280	33.603	66	#11	120.06	134.99
6	#1	16.840	10.191	69	#12	523.05	316.59
8	#1	21.380	10.038	70	#1	26.700	24.148
10	#2	258.86	162.09	72	#1	21.940	31.967
12	#3	92.760	63.06	73	#1	14.040	43.362
15	#1	10.000	28.439	74	#1	25.480	10.149
18	#1	10.000	10.398	76	#1	28.020	16.45
19	#1	10.780	10.023	77	#1	15.820	12.131
24	#1	10.060	13.178	80	#13	370.54	445.55
25	#4	289.98	282.02	85	#1	47.260	18.717
26	#5	411.80	376.55	87	#14	27.400	44.402
27	#1	13.700	29.683	89	#15	392.38	322.79
31	#6	43.100	67.232	90	#1	10.000	20.24
32	#1	11.020	14.144	91	#1	10.000	21.206
34	#1	12.160	12.912	92	#1	10.000	19.163
36	#1	10.300	12.639	99	#1	10.000	10.161
40	#1	14.180	66.505	100	#16	312.88	318.47
42	#1	15.100	19.805	103	#17	82.840	47.058
46	#7	73.420	13.345	104	#1	10.000	39.387
49	#8	101.24	217.88	105	#1	10.000	18.515
54	#9	40.820	52.24	107	#1	40.820	10.248
55	#1	13.140	14.431	110	#1	18.620	10.554
56	#1	14.520	23.335	111	#18	56.280	28.67
59	#10	157.26	59.497	112	#1	12.060	10.833
61	#10	41.920	195.11	113	#1	11.340	22.311
62	#1	11.820	43.015	116	#1	10.380	28.272
Cost (\$/hr)t		6347.2	8278.9				
Losses (MW)		106.788	94.305				

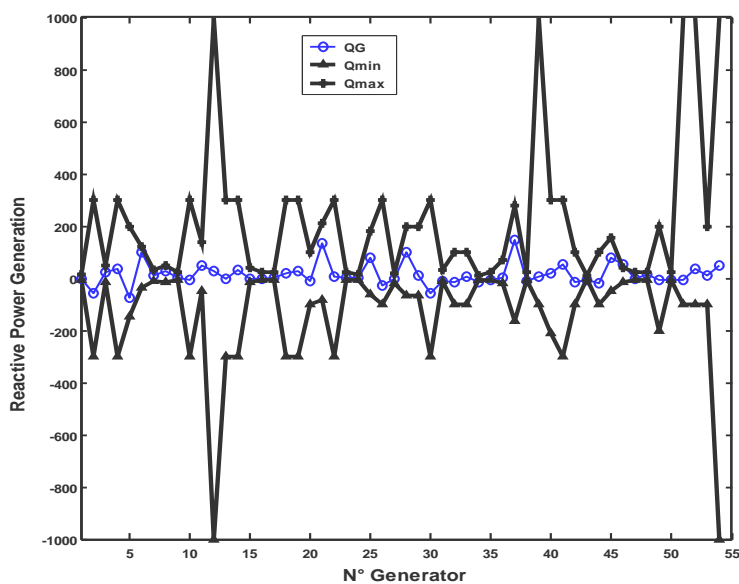

Fig 12 Reactive power generation of IEEE 118-bus electrical network with shunt compensation ($P_d=4242$ MW).

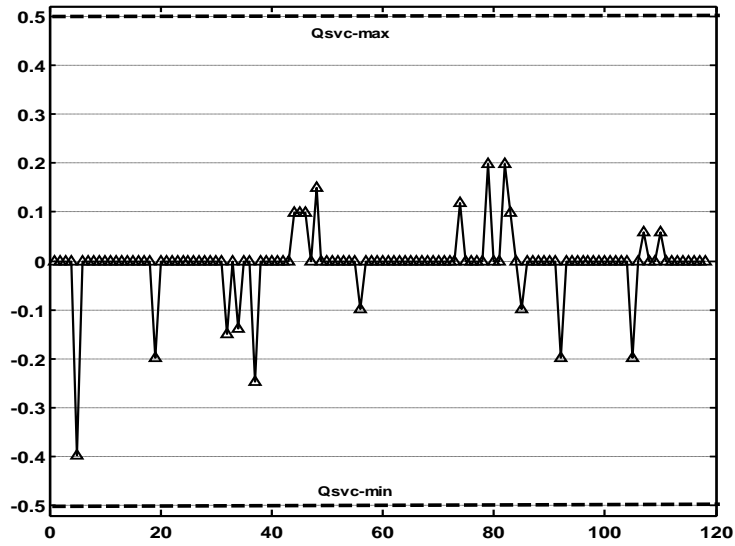

Fig. 13. Reactive power compensation based SVC Compensators exchanged with the IEEE 118-bus electrical network ($P_d=4242$ MW).

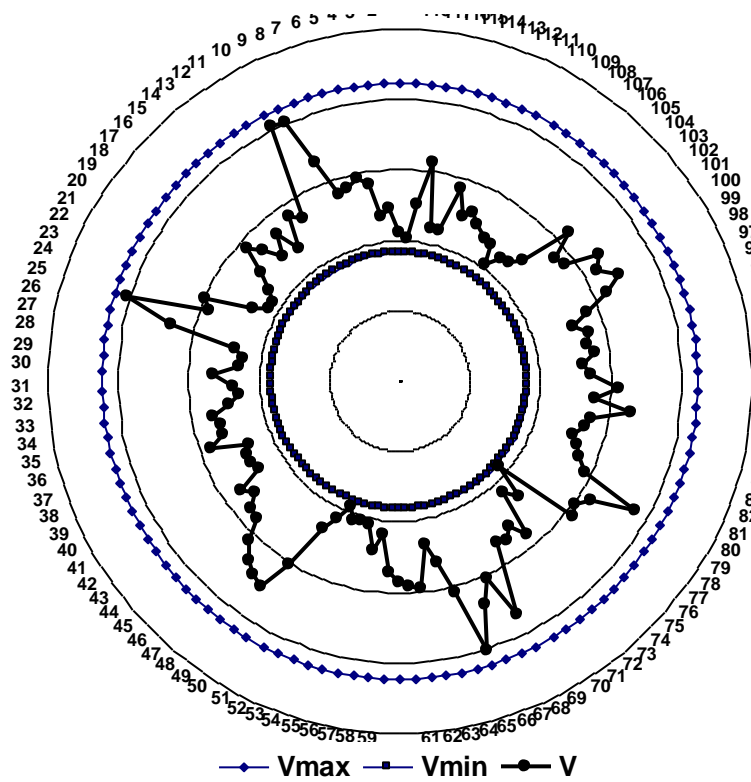

Fig. 14. Voltage profiles of IEEE 118-bus electrical network

VI. CONCLUSION

Efficient parallel GA combined with practical rules is studied for optimal power flow under severe loading conditions (voltage stability).

The main objective of the proposed approach is to improve the performance of the standard GA in term of reduction time execution for an online application to large scale power system and the accuracy of the results with consideration of load incrementation. To save an important CPU time, the original network was decomposed in multi subsystems and the problem transformed to optimize the active power demand associated to each partitioned network. Numerical testing and a comparative analysis show that the proposed algorithm, in most the cases, outperforms other recent approaches reported in the literature.

It is found the proposed approach can converge at the near solution and obtain a competitive solution at critical situations.

As for the future work along this line, the author will strive to develop an adaptive and a flexible algorithm to generalize the application of the proposed approach to large-scale power systems (up to 300-Bus) and with the possibility for an online application.

REFERENCES

- [1] O. Alsac and B. stott. "Optimal load flow with steady state security," *IEEE Trans. Power Appara. Syst.*, pp. 745-751, May-June 1974.
- [2] M. Huneault, and F. D. Galiana, "A survey of the optimal power flow literature," *IEEE Trans. Power Systems*, vol. 6, no. 2, pp. 762-770, May 1991.
- [3] A. G. Bakistzis, P. N. Biskas, C. E. Zoumas, and V. Petridis, "Optimal power flow by enhanced genetic algorithm," *IEEE Trans. Power Systems*, vol. 17, no. 2, pp. 229-236, May 2002.
- [4] C. A. Roa-Sepulveda, B. J. Pavez-Lazo, " A solution to the optimal power flow using simulated annealing," *Electrical Power & Energy Systems (Elsevier)*, vol. 25,n°1, pp.47-57, 2003.

- [5] W. M. Lin, F. S. Cheng, M.T. Tsay, "An improved tabu search for economic dispatch with multiple minima," *IEEE Trans. Power Systems*, vol. 17, no. 1, pp. 108-112, 2002.
- [6] M. A. Abido, "Multi objective evolutionary algorithms for electric power dispatch problem," *IEEE Trans.Evol. Comput.*, vol. 10, no. 3, pp. 315-329, 2006.
- [7] J. Kennedy and R. Eberhart, "Particle swarm optimization," *Proceedings of IEEE International Conference on Neural Networks*, Vol. 4, pp. 1942-1948, Perth, Australia, 1995.
- [8] R. Storn, "Differential evolution-a simple and efficient heuristic for global optimization over continuous spaces," *Journal of Global Optimization* vol. 11, no. 4, pp. 341-359, 1997.
- [9] R. C. Bansal, "Optimization methods for electric power systems: an overview," *International Journal of Emerging Electric Power Systems*, vol. 2, no. 1, pp. 1-23, 2005.
- [10] T. Bouktir, L. Slimani, B. Mahdad, "Optimal power dispatch for large scale power system using stochastic search algorithms," *International Journal of Power and Energy Systems*, vol. 28, no. 1, pp. 1-10, 2008.
- [11] K. Zehar, S. Sayah, "Optimal power flow with environmental constraint using a fast successive linear programming algorithm: application to the algerian power system," *Journal of Energy Conversion and Management*, Elsevier, vol. 49, pp. 3362-3366, 2008.
- [12] C. Chien Kuo, "A novel string structure for economic dispatch problems with practical constraints," *Journal of Energy Conversion and management, Elsevier*, vol. 49, pp. 3571-3577, 2008.
- [13] S. Pothiya, I. Nagamroo, and W. Kongprawechnon, "Application of multiple tabu search algorithm to solve dynamic economic dispatch considering generator constraints," *Journal of Energy Conversion and management, Elsevier*, vol. 49, pp. 506-516, 2008.
- [14] F. Milano, "An open source power system analysis toolbox," *IEEE Trans. Power Systems*, vol. 20, no. 3, pp. 1199-1206, Aug 2005.

- [15] R. D. Zimmerman and D. Gan, MATPOWER - A MATLAB Power System Simulation Package, User's Manual, School of Electrical Engineering, Cornell University, 1997.
- [16] B. Mahdad, T. Bouktir, K. Srairi, "Optimal power flow for large-scale power system with shunt FACTS using fast parallel GA," *The 14th IEEE Mediterranean on Electrotechnical Conference*, 2008. MELECON 5-7 May 2008. pp. 669-676.
- [17] C. R. Feurt-Esquivel, E. Acha, Tan SG, JJ. Rico, "Efficient object oriented power systems software for the analysis of large-scale networks containing FACTS *controlled* branches," *IEEE Trans. Power Systems*, vol. 13, no. 2, pp. 464-472, May 1998.
- [18] S. N. Sivanandam, S.N Deepa, Introduction to Genetic Algorithm, Springer-Verlag Berlin Heidelberg, 2008.
- [19] T. Bouktir, L. Slimani, B. Mahdad, "Optimal power dispatch for large scale power system using stochastic search algorithms," *International Journal of Power and Energy Systems*, vol. 28, no. 1, pp. 1-10, 2008.
- [20] W. Ongskul, T. Tantimaporn, "Optimal power flow by improved evolutionary programming," *Journal of Electric Power Components and system*, vol. 34, no. 1, pp. 79-95, 2006.
- [21] A. Saini, D. K. Chaturvedi, A. K. Saxena, "Optimal power flow solution: a GA-Fuzzy system approach," *International Journal of Emerging Electric Power Systems*, vol. 5, no. 2, pp. 1-21 (2006).
- [22] L. Slimani, T. Bouktir, "Economic power dispatch of power system with pollution control using multiobjective ant colony optimization," *International Journal of Power and Computational Intelligence Research*, vol. 03, no. 2, pp. 145-153, 2007.
- [23] Z. L. Gaing, "Particle swarm optimization to solving the economic dispatch considering the generator constraints," *IEEE Trans. Power Systems*, vol. 18, no. 3, pp. 1187-1195, 2003.

- [24] D. He, F. Wang, Z. Mao, "A hybrid genetic algorithm approach based on differential evolution for economic dispatch with valve-point effect," *Journal of Energy Conversion and management, Elsevier*, vol. 30, pp. 31-38, 2008.
- [25] L. D. S. Coelho, V. C. Mariani, "Improved differential evolution algorithms for handling economic dispatch optimization with generator constraints," *Journal of Energy Conversion and management, Elsevier*, vol. 48, pp. 1631-1639, 2007.