



HAL
open science

Boundary conditions for unit cells from periodical microstructures and their implications

Shuguang Li

► **To cite this version:**

Shuguang Li. Boundary conditions for unit cells from periodical microstructures and their implications. Composites Science and Technology, 2009, 68 (9), pp.1962. 10.1016/j.compscitech.2007.03.035 . hal-00521254

HAL Id: hal-00521254

<https://hal.science/hal-00521254>

Submitted on 27 Sep 2010

HAL is a multi-disciplinary open access archive for the deposit and dissemination of scientific research documents, whether they are published or not. The documents may come from teaching and research institutions in France or abroad, or from public or private research centers.

L'archive ouverte pluridisciplinaire **HAL**, est destinée au dépôt et à la diffusion de documents scientifiques de niveau recherche, publiés ou non, émanant des établissements d'enseignement et de recherche français ou étrangers, des laboratoires publics ou privés.

Accepted Manuscript

Boundary conditions for unit cells from periodical microstructures and their implications

Shuguang Li

PII: S0266-3538(07)00153-4
DOI: [10.1016/j.compscitech.2007.03.035](https://doi.org/10.1016/j.compscitech.2007.03.035)
Reference: CSTE 3664

To appear in: *Composites Science and Technology*

Received Date: 4 December 2006
Revised Date: 27 March 2007
Accepted Date: 30 March 2007

Please cite this article as: Li, S., Boundary conditions for unit cells from periodical microstructures and their implications, *Composites Science and Technology* (2007), doi: [10.1016/j.compscitech.2007.03.035](https://doi.org/10.1016/j.compscitech.2007.03.035)

This is a PDF file of an unedited manuscript that has been accepted for publication. As a service to our customers we are providing this early version of the manuscript. The manuscript will undergo copyediting, typesetting, and review of the resulting proof before it is published in its final form. Please note that during the production process errors may be discovered which could affect the content, and all legal disclaimers that apply to the journal pertain.



**BOUNDARY CONDITIONS FOR UNIT CELLS FROM PERIODICAL
MICROSTRUCTURES AND THEIR IMPLICATIONS****Shuguang Li**

School of MACE, The University of Manchester

Sackville Street, Manchester M60 1QD, UK

Abstract

The most important aspect in formulating unit cells for micromechanical analysis of materials of patterned microstructures is the derivation of appropriate boundary conditions for them. There is lack of a comprehensive account on the derivation of boundary conditions in the literature, while the use of unit cells in micromechanical analyses is on an increasing trend. This paper is devoted to generation of such an account, where boundary conditions are derived entirely based on considerations of symmetries which are present in the microstructure. The implications of the boundary conditions used for a unit cell are not always clear and therefore have been discussed. It has been demonstrated that unit cells of the same appearance but under boundary conditions derived based on different symmetry considerations may behave rather differently. The objective of the paper is to inform users of unit cells that to introduce a unit cell one need not only mechanically correct boundary conditions but also a clear sense of the microstructure under consideration. Otherwise the results of such analyses could mislead.

1 Introduction

Micromechanical analyses have been on an increasing trend in order to understand the behaviour of modern materials with sophisticated microstructures, e.g. fibre or particulate reinforced composites, textile composites, etc.. Unit cells are often resorted to in order to facilitate such analyses. The introduction of a unit cell is usually based on certain assumptions, such as a regular pattern in the microstructure, which is sometime a reasonable approximation or an idealisation otherwise. A regular pattern offers certain symmetries which can then be employed to derive the boundary conditions for a unit cell introduced for micromechanical analysis. Several accounts on systematic use of symmetries for the derivation of the boundary conditions for unit cells have been presented by the author in [1-3]. In the literature, there are many accounts where simplistic boundary conditions have been imposed to unit cells in an intuitive manner, sometimes, rather casually without much justification. In [4], boundary conditions have been so introduced that boundary effects have been brought in and a significant effort has been made there to include more cells to

form larger unit cells to dilute the boundary effects. This would be absolutely unnecessary, had the boundary conditions been derived appropriately. In many publications [4-9], to name but a few, boundaries have been assumed to remain flat or straight after deformation to deliver simple boundary conditions, which cannot usually be fulfilled when the material is subjected to the macroscopic shear deformation. Such simplistic boundary conditions are correct in a few special cases, e.g. square unit cells with reflectional symmetric microstructure when they are subjected to a deformation corresponding to a macroscopic direct strain. Even so, they do not come without implications on the patterns of the microstructures, which do not seem to have been given any attention hitherto. Another confusing issue is how many boundary conditions need to be prescribed at any given part of the boundary of a unit cell. Sometime, only one displacement has been prescribed but in some other times more are prescribed. In [10], equilibrium or compatibility conditions were imposed. No clear explanations can be found in the literature. This paper is devoted to the issues as raised above, in particular, the confusing issues associated with the use of reflectional symmetries.

Because of the nature of the symmetries employed, the boundary conditions obtained for the unit cells are often in a form of equations relating displacements on one part of the boundary to those on another. This may impose restrictions on the applications of these boundary conditions and hence the unit cells. For instance, when finite elements are employed for the micromechanical analysis, as is often the case, the mesh to be generated must possess identical tessellation between the parts of boundary which are related through those equation boundary conditions. This could sometimes be difficult to achieve for 3-D problems, such as in particle reinforced or textile composites. The constraints in equation form may not be available in some codes. It is therefore desirable to avoid such equation boundary conditions wherever it is possible.

2 Sufficient and necessary number of boundary conditions for unit cells

In the literature, it is often found, e.g. in [11], that the number of boundary conditions prescribed at the same part of the boundary varies from case to case. Without appropriate justification, it is presented as a rather confusing matter. As a result, incorrect usages are often found, e.g. in [4]. Some of the confusions result from the use of finite elements which is usually based on a variational principle of some kind in which some boundary conditions, called natural boundary conditions, are satisfied automatically as a part of the variation process and should not be imposed. Almost all commercial FE codes are displacement-based built on the basis of the minimum total potential energy principle or the virtual displacement principle. In such codes, traction boundary conditions

are natural boundary conditions and the users do not need to impose any constraints in order to have them satisfied apart from an appropriate prescription of tractions, if any, as part of the load to the structure under analysis.

It should be emphasised that natural boundary conditions should not be imposed prior to the variation process. It does not help to obtain a more accurate result but, rather on the contrary, it may prevent the total potential energy to reach its minimum in the solution space and hence lead to less accurate result. To illustrate, a simply support beam as shown in Fig. 1 under uniformly distributed load is considered as a simple example. Assuming an approximate deflection pattern as a quadratic function $ax^2 + bx + c$, after imposing the zero deflection boundary conditions at both ends, the minimisation of the total potential energy results in a non-dimensional deflection $x(1-x)$ as opposed to the exact solution of $x(1-x)(1+x-x^2)$. The maximum deflection is 20% less than the exact solution while the moment-free natural boundary conditions have only been satisfied approximately as far as the assumed deflection function allows. The approximate total potential energy is $-20/60$ as opposed to the exact solution of $-21/60$. However, if one imposes the moment-free boundary conditions (natural boundary conditions) at both ends to the quadratic deflection function prior to variation, the beam would not deflect at all, given 100% error in deflection and the total potential energy is 0 which is obviously a much worse approximation to $-21/60$ than $-20/60$.

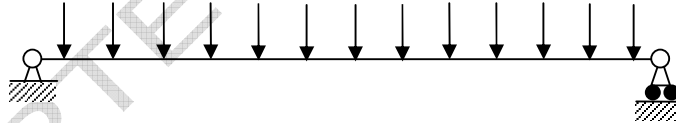

Figure 1 A simply supported beam under uniformly distributed load

According the theory of continuum mechanics for the deformation problem of materials in 3-D space, at any given point on the boundary, there require three prescribed boundary conditions in any logical combination of displacements and tractions. For instance, for a boundary perpendicular to the x -axis, the three boundary conditions can be a prescription of the following

$$\left\{ \begin{array}{lll} u & \text{OR} & \sigma_x \\ v & \text{OR} & \tau_{xy} \\ w & \text{OR} & \tau_{xz} \end{array} \right. \quad (1)$$

where u , v and w are displacements in x , y and z directions respectively and σ and τ are direct and shear stress components with subscripts in their conventional sense. In terminology of partial differential equations, displacement boundary conditions are boundary condition of the first kind

and traction ones are the second kind. There could be a third kind corresponding to elastic support physically, which are however irrelevant to the present topic and hence dropped from present considerations.

When the boundary conditions are imposed in a form of equations relating the displacements or tractions on one part of the boundary to those of another part of the boundary, the equation boundary conditions should be imposed to

$$\left\{ \begin{array}{lll} u & \text{and} & \sigma_x \\ v & \text{and} & \tau_{xy} \\ w & \text{and} & \tau_{xz} . \end{array} \right. \quad (2)$$

Instead of three boundary conditions on one part of the boundary, there are six boundary conditions for two parts of the boundary.

Bearing in mind that traction boundary conditions are natural boundary conditions in conventional FE analysis, they will be left out of the prescription list. For example, if a part of boundary is subjected to prescribed

$$\left\{ \begin{array}{l} u \\ \tau_{xy} \\ \tau_{xz} \end{array} \right.$$

it is sufficient and necessary to prescribe u only on this part of boundary for the FE analysis.

Applying the same argument to equation boundary conditions, it is obvious that equation constraints have to be imposed to all three displacements to be both sufficient and necessary, whereas equations for tractions can and should be left out, as in [2,3].

Because of the existence of natural boundary conditions which do not need to be imposed, the same part of the boundary under different loading cases may be subjected to different numbers of boundary conditions, especially when reflectional symmetries are employed.

Another source of confusion is the nature of symmetry. The loading and deformation can be symmetric as well as antisymmetric. Distinguish one from another is essential in derive appropriate boundary conditions associated with symmetry. For example, when a deformable body symmetric about the x -plane ($x=0$) is under symmetric loading, e.g. stretching in the x -direction, there is one boundary condition on the symmetry plane, i.e.

$$u = 0$$

while the two remaining traction boundary conditions should not be prescribed. However, when the same body is subjected to antisymmetric loading, e.g. shear in the x - y plane, there will be two boundary conditions on the symmetry plane, i.e.

$$v = 0 \quad \text{and} \quad w = 0$$

and there is only one traction boundary condition in this case, which should not be imposed.

Another potential source of confusion is associated with bending problem, when elements, such as beams, plates and shells, are involved, where displacements are in a generalised sense, i.e. nodal rotations are considered as displacements. Boundary conditions described in terms of bending moments and shear forces are generalised traction boundary conditions and hence natural boundary conditions in the terminology of variational principles.

To conclude this section, it is clear that at a boundary of a unit cell, the number of boundary conditions to be imposed before a finite element analysis can be conducted is not definite. It depends on the nature of the symmetries adopted in the definition of the unit cell. However, one thing remains definite, which should guide the introduction of boundary conditions, i.e. only displacement boundary conditions should be imposed, not the natural boundary conditions. When bending is involved, displacements should include generalised displacements, such as nodal rotations.

3 Selection of unit cells and their implications

For argument's sake, a microstructure in 2-D space of a square layout as shown in Fig. 2a is considered first, which can be perceived as, but not restricted to, a transverse cross-section of a UD composite or an in-plane pattern of a textile composite. As the only symmetries available are translations, in x and y directions, respectively, the unit cell as shown in Fig. 2b will have to be subjected to equation boundary conditions as given in [2] in terms of displacements while ignoring the traction ones.

However, if the material under consideration allows one to idealise it into a microstructure as shown in Fig. 3a, the repetitive cell as shown in Fig. 3b would be the unit cell of smallest size if only translational symmetries are employed. Obviously, the size of the unit cell can be reduced to that as shown in Fig. 3c after the available reflectional symmetries about x and y axes have been utilised. As a result, boundary conditions can be obtained without equations relating the displacements on the opposite sides. Having used the reflectional symmetries, one needs to bear in mind two issues

associated with a unit cell as given in Fig. 3c, which can be easily overlooked. Firstly, the microstructure of the material the unit cell as in Fig. 3c represents is given in Fig. 3a not as in Fig. 2a although the appearances of the unit cells in Fig 2b and Fig. 3c look identical. Secondly, some macroscopic strain states, in particular, associated with shear, are antisymmetric under the reflectional symmetry transformations. Appropriate considerations should be given to the antisymmetric nature when boundary conditions are derived from the symmetry transformations. As a result, the number of boundary conditions for some load cases would be different from that for the other cases.

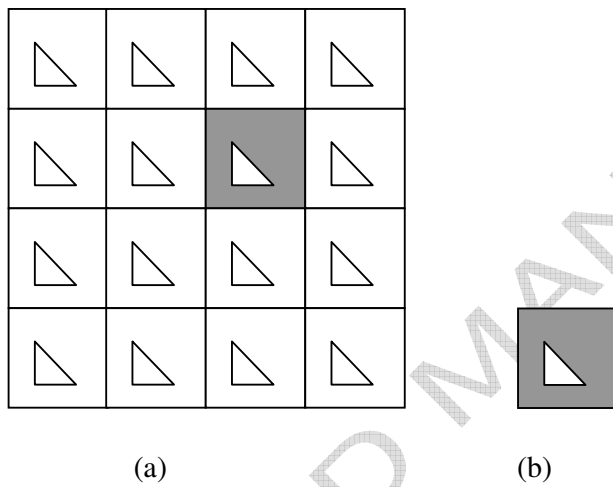

Fig. 2 Square packing

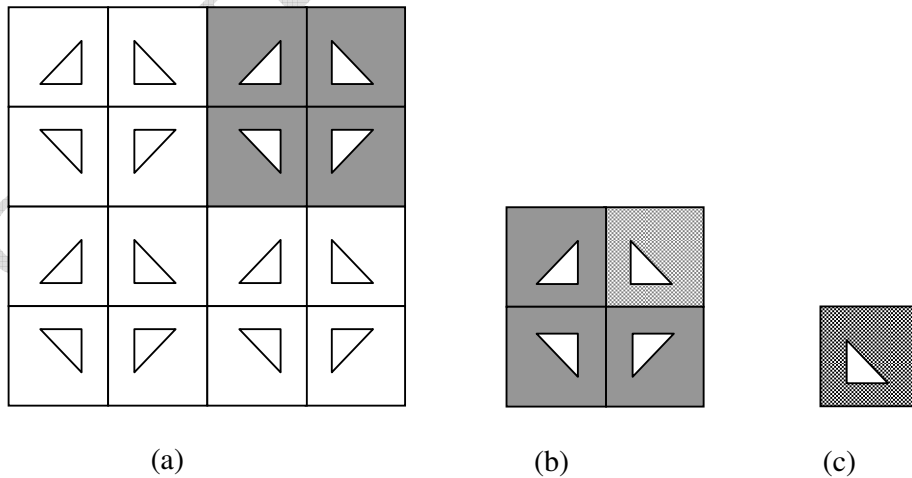

Fig. 3 Square packing with further reflectional symmetries

Sometimes, for patterns like the one as shown in Fig. 4a, unit cells of only a quarter of the size as shown in Fig. 4c are seen in the literature. It, in fact, results from exactly the same consideration as

in Fig. 3. A quarter is sufficient only because the presence of the reflectional symmetries about the x and y axes within the repetitive cell as shown in Fig. 4b. Many regular shapes of the inclusion possess these symmetries, such as diamond, rectangle and circle, but there are also shapes which do not possess such symmetries, e.g. that in Fig. 2a. The conditions implied by a quarter size unit cell are the existence of reflectional symmetries, as in Fig. 3. The boundary conditions for a quarter size unit cell should be derived in exactly the same way as that for the unit cell in Fig. 3c.

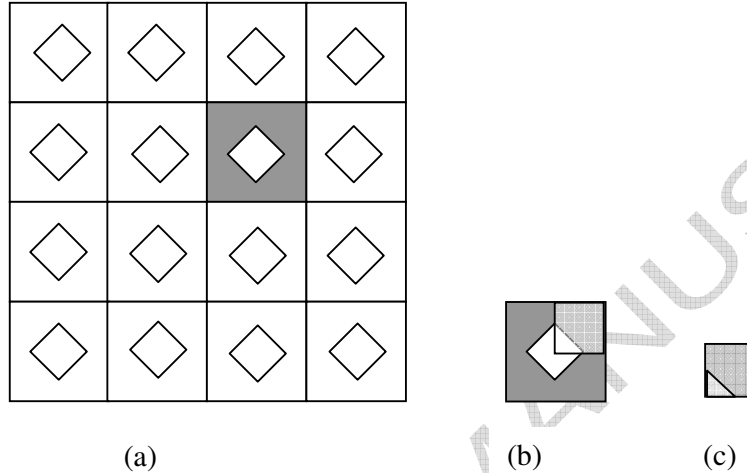

Fig. 4 An equivalent layout to that in Fig. 3

The ultimate unit cells obtained from Fig.3 and Fig. 4 share the same appearance. However, they are under different boundary conditions and associated with different microstructures. An obvious consequence of the difference in the microstructure is that the one in Fig.4a is macroscopically orthotropic while that in Fig. 3a is not necessarily the case, as will be seen later through an example. Users of unit cells should be aware of the difference and decide if the difference bears any significance for their particular applications while choosing the unit cell to be employed.

Another regular pattern often encountered in the literature is hexagonal one. Argument similar to above for the square pattern applies to a large extent. The only difference is that there are more ways to express the translational symmetries as discussed fully in [1,2]. Whether the repetitive cell used to express the translations symmetries can be further reduced in size depends on the existence of the other symmetries, including reflectional and rotational. Without such additional symmetries, the smallest size would be a complete hexagon as shown in Fig. 5, if one is prepared to employ translations in direction not perpendicular to each other. Otherwise, to trade for translations in x and y directions only, one will have to deal with unit cell a size bigger as shown in the rectangle in

Fig. 5, which is obviously not a unique choice. When analysing these unit cells, in general, equation boundary conditions will have to be employed.

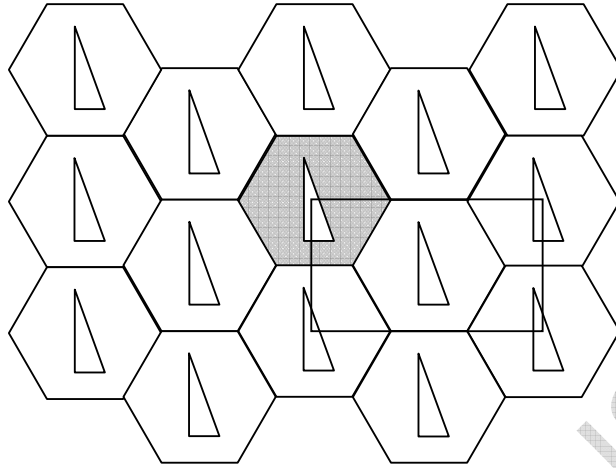

Fig. 5 Hexagonal packing

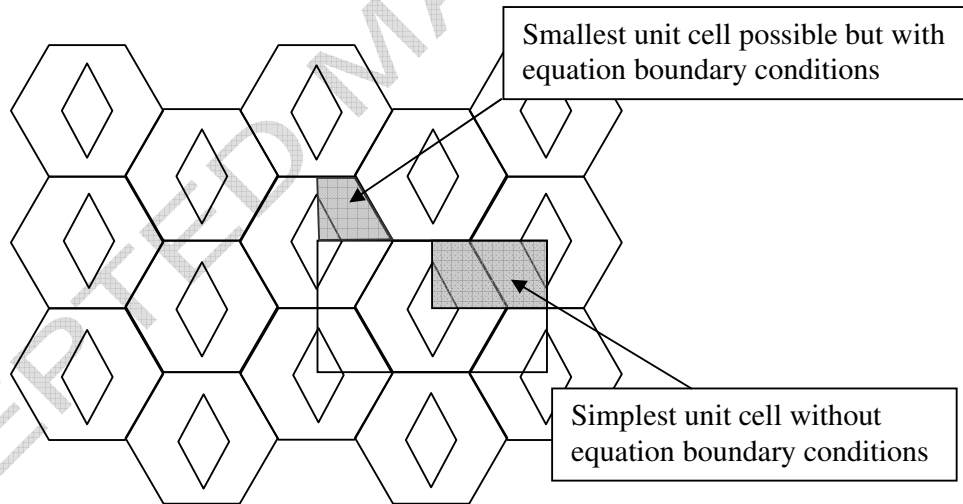

Fig. 6 Hexagonal packing with reflectional symmetries

However, if the microstructure possesses additional symmetries, typically, reflectional symmetries within the repetitive cells, the size of the unit cells can be further reduced as shown in Fig 6. The trapezium unit cell is apparently the smallest in size. However, it will involve some boundary conditions in form of equations. The shaded rectangle unit cell can be derived free from equation boundary conditions, which remains as the simplest unit cell as far as the boundary conditions are concerned. Unit cells of other shapes as suggested in [1,2] will definitely bear more complicated

boundary conditions. The boundary conditions for the rectangular unit cell can be derived in the same ways as those as presented earlier for the square pattern. It should be noted that those unit cells of reduced sizes as shaded in Fig. 6 cannot be obtained without reflectional symmetries about vertical and horizontal axes.

4 Boundary conditions for a unit cell from 3-D microstructure with reflectional symmetries

Put the case as illustrated through Fig. 3 into a 3-D scenario. The boundary conditions can be derived in general as follows, assuming the periods of translational symmetries in the x , y and z directions are $2b_x$, $2b_y$ and $2b_z$, respectively. This is general enough to encapsulate regular packing layouts such as simple cubic with $b_x = b_y = b_z = b$, body centred cubic with $b_x = b_y = b_z = \frac{4}{\sqrt{3}}b$, face centred cubic with $b_x = b_y = b_z = \frac{4}{\sqrt{2}}b$ and close packed hexagonal with $b_x = \frac{4}{\sqrt{2}}b$, $b_y = 2b$ and $b_z = 2\sqrt{3}b$, respectively, where b is the characteristic radius, i.e. the radius of largest sphere which can be accommodated, as defined in [3] for each packing. Obviously, the size of the unit cells for body centred cubic, face centred cubic and close packed hexagonal packing are no longer as compact as in [3].

Assume that there exists an intermediate repetitive cell equivalent to that in Fig. 3b which can represent the material fully using translational symmetries only and this cell is defined in the domain

$$\begin{aligned} -b_x &\leq x \leq b_x \\ -b_y &\leq y \leq b_y \\ -b_z &\leq z \leq b_z \end{aligned} \quad (3)$$

The material is subjected to a set of macroscopic strains $\{\epsilon_x^0, \epsilon_y^0, \epsilon_z^0, \gamma_{yz}^0, \gamma_{zx}^0, \gamma_{xy}^0\}$ which can be introduced as six extra degrees of freedom (d.o.f.) in a FE analysis, e.g. as six individual nodes, each having a single d.o.f., or six degrees of freedom of a special node. Upon any of these extra d.o.f.'s, a concentrated force can be applied in order to impose a macroscopic stress to produce a macroscopically uniaxial stress state.

The translational symmetries require:

$$\begin{aligned}
u|_{x=b_x} - u|_{x=-b_x} &= 2b_x \varepsilon_x^0 & \sigma_x|_{x=b_x} - \sigma_x|_{x=-b_x} &= 0 \\
v|_{x=b_x} - v|_{x=-b_x} &= 0 & \tau_{xy}|_{x=b_x} - \tau_{xy}|_{x=-b_x} &= 0 \\
w|_{x=b_x} - w|_{x=-b_x} &= 0 & \tau_{xz}|_{x=b_x} - \tau_{xz}|_{x=-b_x} &= 0
\end{aligned} \quad \text{and} \quad (4)$$

under translation in x -direction;

$$\begin{aligned}
u|_{y=b_y} - u|_{y=-b_y} &= 2b_y \gamma_{xy}^0 & \tau_{yx}|_{y=b_y} - \tau_{yx}|_{y=-b_y} &= 0 \\
v|_{y=b_y} - v|_{y=-b_y} &= 2b_y \varepsilon_y^0 & \sigma_y|_{y=b_y} - \sigma_y|_{y=-b_y} &= 0 \\
w|_{y=b_y} - w|_{y=-b_y} &= 0 & \tau_{yz}|_{y=b_y} - \tau_{yz}|_{y=-b_y} &= 0
\end{aligned} \quad \text{and} \quad (5)$$

under translation in y -direction,

$$\begin{aligned}
u|_{z=b_z} - u|_{z=-b_z} &= 2b_z \gamma_{xz}^0 & \tau_{zx}|_{z=b_z} - \tau_{zx}|_{z=-b_z} &= 0 \\
v|_{z=b_z} - v|_{z=-b_z} &= 2b_z \gamma_{yz}^0 & \tau_{zy}|_{z=b_z} - \tau_{zy}|_{z=-b_z} &= 0 \\
w|_{z=b_z} - w|_{z=-b_z} &= 2b_z \varepsilon_z^0 & \sigma_z|_{z=b_z} - \sigma_z|_{z=-b_z} &= 0
\end{aligned} \quad \text{and} \quad (6)$$

under translation in z -direction.

The form of many of the above equations is not unique, especially, those associated with shear, depending on the way rigid body rotations are constrained. For instance, the first two equations in (5) can be replaced by

$$\begin{aligned}
u|_{y=b_y} - u|_{y=-b_y} &= 0 & v|_{y=b_y} - v|_{y=-b_y} &= 2b_y \varepsilon_y^0 + 2b_x \gamma_{xy}^0 \\
u|_{y=b_y} - u|_{y=-b_y} &= b_y \gamma_{xy}^0 & v|_{y=b_y} - v|_{y=-b_y} &= 2b_y \varepsilon_y^0 + b_x \gamma_{xy}^0
\end{aligned}$$

without affecting the results. The lack of uniqueness contributes to the likelihood of confusion when introducing boundary conditions for unit cells.

The use of boundary conditions derived from translational symmetries alone as shown in (4)-(6) has been illustrated fully in [3]. It is the interest of the present paper to derive appropriate boundary conditions when further reflectional symmetries are present in the intermediate repetitive cell as defined above.

To apply further reflectional symmetries about x , y and z planes, the problem has to be considered separately for individual loading cases expressed in terms of macroscopic stresses $\{\sigma_x^0, \sigma_y^0, \sigma_z^0, \tau_{yz}^0, \tau_{zx}^0, \tau_{xy}^0\}$ as presented in the following subsections.

In deriving the boundary conditions in the following subsections, the principle of symmetries will be employed, which states that symmetric stimuli, i.e. loads, result in symmetric responses,

including displacements, strains and stresses, while antisymmetric stimuli produce antisymmetric responses

4.1 Under σ_x^0

Consider first the x -faces of the unit cell, i.e. those perpendicular to the x -axis. σ_x^0 as a stimulus is symmetric under reflection about x -plane (perpendicular to x -axis). Responses v , w and σ_x are symmetric while u , τ_{xy} and τ_{xz} are antisymmetric. On the symmetry plane ($x=0$), the symmetry conditions require

$$\begin{aligned} u|_{x=0} &= -u|_{x=0} & \sigma_x|_{x=0} &= \sigma_x|_{x=0} \\ v|_{x=0} &= v|_{x=0} & \tau_{xy}|_{x=0} &= -\tau_{xy}|_{x=0} \\ w|_{x=0} &= w|_{x=0} & \tau_{xz}|_{x=0} &= -\tau_{xz}|_{x=0} \end{aligned} \quad \text{and} \quad (7)$$

which can be re-expressed as

$$\begin{aligned} u|_{x=0} &= 0 & \sigma_x|_{x=0} &= \sigma_x|_{x=0} \rightarrow \text{free} \\ v|_{x=0} &= v|_{x=0} \rightarrow \text{free} & \tau_{xy}|_{x=0} &= 0 \\ w|_{x=0} &= w|_{x=0} \rightarrow \text{free} & \tau_{xz}|_{x=0} &= 0 \end{aligned} \quad \text{and} \quad (8)$$

The only boundary condition in effect on side $x=0$ is

$$u|_{x=0} = 0 \quad (9)$$

while traction boundary conditions are natural boundary conditions and should not be imposed.

In the above, the conditions on $v|_{x=0}$, $w|_{x=0}$ and $\sigma_x|_{x=0}$ do not yield any constraints and they should hence be left free, as indicated by “ \rightarrow free”. The same notation will be adopted for the rest of the paper.

Considering the opposite faces at $x = \pm b_x$, and applying the symmetry condition, one has

$$\begin{aligned} u|_{x=b_x} &= -u|_{x=-b_x} & \sigma_x|_{x=b_x} &= \sigma_x|_{x=-b_x} \\ v|_{x=b_x} &= v|_{x=-b_x} & \tau_{xy}|_{x=b_x} &= -\tau_{xy}|_{x=-b_x} \\ w|_{x=b_x} &= w|_{x=-b_x} & \tau_{xz}|_{x=b_x} &= -\tau_{xz}|_{x=-b_x} \end{aligned} \quad \text{and} \quad (10)$$

In conjunction with the translational symmetry conditions as given in (4), one obtains

$$\begin{aligned}
u|_{x=b_x} &= b_x \varepsilon_x^0 & \sigma_x|_{x=b_x} &= \sigma_x|_{x=b_x} \rightarrow \text{free} \\
v|_{x=b_x} &= v|_{x=b_x} \rightarrow \text{free} & \text{and} & \tau_{xy}|_{x=b_x} &= 0 \\
w|_{x=b_x} &= w|_{x=b_x} \rightarrow \text{free} & & \tau_{xz}|_{x=b_x} &= 0 .
\end{aligned} \tag{11}$$

The only surviving boundary condition on side $x = b_x$ is

$$u|_{x=b_x} = b_x \varepsilon_x^0 . \tag{12}$$

The boundary condition above introduces an extra d.o.f. ε_x^0 into the system. In an FE analysis, in order to impose a macroscopic stress σ_x^0 , an appropriate concentrated force can be applied to this d.o.f.. The macroscopic effective stress σ_x^0 can be worked out from the concentrated force easily as discussed in [3] while the obtained nodal displacement at this extra d.o.f. gives the effective macroscopic strain ε_x^0 directly.

Consider now the two opposite faces at $y = \pm b_y$. The stimulus σ_x^0 is also symmetric under reflection about y -plane (perpendicular to y -axis). Responses u , w and σ_y are symmetric while v , τ_{yx} and τ_{yz} are antisymmetric. Hence, on the symmetry plane ($y=0$) the symmetry conditions require

$$\begin{aligned}
u|_{y=0} &= u|_{y=0} & \tau_{yx}|_{y=0} &= -\tau_{yx}|_{y=0} \\
v|_{y=0} &= -v|_{y=0} & \text{and} & \sigma_y|_{y=0} &= \sigma_y|_{y=0} \\
w|_{y=0} &= w|_{y=0} & & \tau_{yz}|_{y=0} &= -\tau_{yz}|_{y=0}
\end{aligned} \tag{13}$$

which can be rewritten as

$$\begin{aligned}
u|_{y=0} &= u|_{y=0} \rightarrow \text{free} & \tau_{yx}|_{y=0} &= 0 \\
v|_{y=0} &= 0 & \text{and} & \sigma_y|_{y=b_y} &= \sigma_y|_{y=b_y} \rightarrow \text{free} \\
w|_{y=0} &= w|_{y=0} \rightarrow \text{free} & & \tau_{yz}|_{y=0} &= 0 .
\end{aligned} \tag{14}$$

Leaving the natural boundary conditions aside, a single boundary condition on side $y=0$ is obtained

$$v|_{y=0} = 0 . \tag{15}$$

The symmetry conditions on the two opposite faces at $y = \pm b_y$ require

$$\begin{aligned}
 u|_{y=b_y} &= u|_{y=-b_y} & \tau_{yx}|_{y=b_y} &= -\tau_{yx}|_{y=-b_y} \\
 v|_{y=b_y} &= -v|_{y=-b_y} & \sigma_y|_{y=b_y} &= \sigma_y|_{y=-b_y} \\
 w|_{y=b_y} &= w|_{y=-b_y} & \tau_{yz}|_{y=b_y} &= -\tau_{yz}|_{y=-b_y} .
 \end{aligned} \tag{16}$$

The above in conjunction with (5) lead to

$$\begin{aligned}
 u|_{y=b_y} &= u|_{y=b_y} \rightarrow \text{free} & \tau_{yx}|_{y=b_y} &= 0 \\
 v|_{y=b_y} &= b_y \varepsilon_y^0 & \sigma_y|_{y=b_y} &= \sigma_y|_{y=b_y} \rightarrow \text{free} \\
 w|_{y=b_y} &= w|_{y=b_y} \rightarrow \text{free} & \tau_{yz}|_{y=b_y} &= 0
 \end{aligned} \tag{17}$$

which result in a single boundary condition for side $y = b_y$,

$$v|_{y=b_y} = b_y \varepsilon_y^0 \tag{18}$$

The boundary condition above introduces another extra d.o.f. ε_y^0 into the system. To impose a uniaxial macroscopic stress σ_x^0 , d.o.f. ε_y^0 should be left free, i.e. $\sigma_y^0 = 0$. The nodal displacement at the extra d.o.f. ε_y^0 gives this macroscopic strain directly.

Applying the same arguments, the boundary conditions on sides $z = 0$ and $z = b_z$ can be obtained as

$$w|_{z=0} = 0 \quad \text{and} \quad w|_{z=b_z} = b_z \varepsilon_z^0, \quad \text{respectively} \tag{19}$$

where the extra d.o.f. ε_z^0 was introduced through translational symmetry conditions (6). To impose a macroscopic stress σ_x^0 alone, ε_z^0 should be left free, i.e. $\sigma_z^0 = 0$. The nodal displacement at the extra d.o.f. ε_z^0 gives this macroscopic strain directly.

To summarise, under a macroscopic stress σ_x^0 , the boundary conditions on the three pairs of the sides of the unit cell are given by (9), (12), (15), (18) and (19)

$$\begin{aligned}
 u|_{x=0} &= 0 & \text{and} & & u|_{x=b_x} &= b_x \varepsilon_x^0 \\
 v|_{y=0} &= 0 & \text{and} & & v|_{y=b_y} &= b_y \varepsilon_y^0 \\
 w|_{z=0} &= 0 & \text{and} & & w|_{z=b_z} &= b_z \varepsilon_z^0
 \end{aligned} \tag{20}$$

where extra d.o.f. ε_x^0 is subjected to a concentrated force associated with σ_x^0 , while ε_y^0 and ε_z^0 should be left free to produce a macroscopically uniaxial stress state σ_x^0 .

4.2 Under σ_y^0

With similar considerations as given above, the boundary conditions for the unit cell under σ_y^0 are identical to those in (20). The only difference is that it should be the extra d.o.f. ε_y^0 that is subjected to a concentrated force associated with σ_y^0 , while ε_x^0 and ε_z^0 left free to produce a macroscopically uniaxial stress state σ_y^0 . The nodal displacements at those extra d.o.f.'s give the corresponding macroscopic strains directly.

4.3 Under σ_z^0

The boundary conditions are again identical to those in (20). However, the extra d.o.f. ε_z^0 should be subjected to a concentrated force associated with σ_z^0 , while ε_x^0 and ε_y^0 left free to produce a macroscopically uniaxial stress state σ_z^0 .

4.4 Under τ_{yz}^0

The nature of shear stresses is slightly more complicated than their direct counterparts. With respect to a reflectional symmetry, one of the three shear components is symmetric while other two are antisymmetric. Under the reflection about the x -plane, the stimulus τ_{yz}^0 is symmetric. The responses v , w and σ_x are symmetric while u , τ_{xy} and τ_{xz} are antisymmetric. Hence, on the symmetry plane, $x=0$, the symmetry conditions require

$$\begin{aligned} u|_{x=0} &= -u|_{x=0} & \sigma_x|_{x=0} &= \sigma_x|_{x=0} \\ v|_{x=0} &= v|_{x=0} & \tau_{xy}|_{x=0} &= -\tau_{xy}|_{x=0} \\ w|_{x=0} &= w|_{x=0} & \tau_{xz}|_{x=0} &= -\tau_{xz}|_{x=0} \end{aligned} \quad \text{and} \quad (21)$$

which can be rewritten into

$$\begin{aligned} u|_{x=0} &= 0 & \sigma_x|_{x=0} &= \sigma_x|_{x=0} \rightarrow \text{free} \\ v|_{x=0} &= v|_{x=0} \rightarrow \text{free} & \tau_{xy}|_{x=0} &= 0 \\ w|_{x=0} &= w|_{x=0} \rightarrow \text{free} & \tau_{xz}|_{x=0} &= 0. \end{aligned} \quad (22)$$

Ignoring the traction boundary conditions, the only boundary condition to be imposed is

$$u|_{x=0} = 0. \quad (23)$$

On the opposite faces at $x = \pm b_x$, the reflectional symmetry conditions are similar to (21) but on $x = \pm b_x$ instead of $x=0$. In conjunction with the translational symmetry conditions (4), they lead to the boundary condition

$$u|_{x=\pm b_x} = 0. \quad (24)$$

Consider now the pair of sides parallel to the y -plane. The stimulus τ_{yz}^0 is antisymmetric about y -plane ($y=0$). The responses u , w and σ_y are symmetric while v , τ_{yx} and τ_{yz} are antisymmetric.

Hence, on the symmetry plane, the symmetry conditions require

$$\begin{aligned} u|_{y=0} &= -u|_{y=0} & \tau_{yx}|_{y=0} &= \tau_{yx}|_{y=0} \\ v|_{y=0} &= v|_{y=0} & \sigma_y|_{y=0} &= -\sigma_y|_{y=0} \\ w|_{y=0} &= -w|_{y=0} & \tau_{yz}|_{y=0} &= \tau_{yz}|_{y=0} \end{aligned} \quad \text{and} \quad (25)$$

Rewrite

$$\begin{aligned} u|_{y=0} &= 0 & \tau_{yx}|_{y=0} &= \tau_{yx}|_{y=0} \rightarrow \text{free} \\ v|_{y=0} &= v|_{y=0} \rightarrow \text{free} & \sigma_y|_{y=0} &= 0 \\ w|_{y=0} &= 0 & \tau_{yz}|_{y=0} &= \tau_{yz}|_{y=0} \rightarrow \text{free} \end{aligned} \quad \text{and} \quad (26)$$

From (26), the boundary conditions on $y=0$ are obtained as

$$u|_{y=0} = w|_{y=0} = 0. \quad (27)$$

Notice that there are two displacement boundary conditions in this case as opposed to the $x=0$ plane on which there is only one boundary condition as given in (24). They have to be imposed in order to define the unit cell properly under this loading condition. There is one traction boundary condition $\sigma_y|_{y=0} = 0$ which has been ignored as a natural boundary condition in an FE analysis.

Applying the reflectional symmetry to the two opposite faces at $y = \pm b_y$, one obtains

$$\begin{aligned} u|_{y=b_y} &= -u|_{y=-b_y} & \tau_{yx}|_{y=b_y} &= \tau_{yx}|_{y=-b_y} \\ v|_{y=b_y} &= v|_{y=-b_y} & \sigma_y|_{y=b_y} &= -\sigma_y|_{y=-b_y} \\ w|_{y=b_y} &= -w|_{y=-b_y} & \tau_{yz}|_{y=b_y} &= \tau_{yz}|_{y=-b_y} \end{aligned} \quad \text{and} \quad (28)$$

Combining the above with (5), one obtains

$$\begin{aligned}
u|_{y=b_y} &= 0 & \tau_{yx}|_{y=b_y} &= \tau_{yx}|_{y=b_y} \rightarrow \text{free} \\
v|_{y=b_y} &= v|_{y=b_y} \rightarrow \text{free} & \text{and} & \sigma_y|_{y=b_y} = 0 \\
w|_{y=b_y} &= 0 & \tau_{yz}|_{y=b_y} &= \tau_{yz}|_{y=b_y} \rightarrow \text{free}
\end{aligned} \tag{29}$$

which lead to the following boundary conditions for side $y = b_y$,

$$u|_{y=b_y} = w|_{y=b_y} = 0. \tag{30}$$

Similarly, the boundary conditions on $z=0$ and $z = b_z$ can be obtained, bearing in mind that τ_{yz}^0 is antisymmetric about z -plane

$$\begin{aligned}
u|_{z=0} &= v|_{z=0} = 0 \\
u|_{z=b_z} &= 0 \quad \text{and} \quad v|_{z=b_z} = b_z \gamma_{yz}^0
\end{aligned} \tag{31}$$

where the extra d.o.f. γ_{yz}^0 is introduced through the translational symmetry conditions (6), which can be associated with $u|_{z=b_z}$ instead of $v|_{z=b_z}$ if the rigid body rotation of the unit cell is constrained differently. There will be no difference whatsoever as far as the deformation is concerned. The same applies to the consideration on the two subsequent loading cases without further explanations. To impose a macroscopic stress τ_{yz}^0 , a concentrate force can be applied to the d.o.f. γ_{yz}^0 . The nodal displacement at γ_{yz}^0 obtained after the analysis gives the corresponding macroscopic strain directly. Since w is not constrained on $z=0$ and $z = b_z$, these faces do not have to remain flat after deformation.

As a summary, all boundary conditions for the unit cell under macroscopic stress τ_{yz}^0 are as follows

$$\begin{aligned}
u|_{x=0} &= 0, & u|_{x=b_x} &= 0 \\
u|_{y=0} &= w|_{y=0} = 0, & u|_{y=b_y} &= w|_{y=b_y} = 0 \\
u|_{z=0} &= v|_{z=0} = 0, & u|_{z=b_z} &= 0 \quad \& \quad v|_{z=b_z} = b_z \gamma_{yz}^0.
\end{aligned} \tag{32}$$

Notice that there are different numbers of conditions on different sides. In general, symmetry results in one condition while antisymmetry two. The same applies to the subsequent shear loading cases where details of derivation are omitted.

4.5 Under τ_{xz}^0

After considering all symmetry conditions, the boundary conditions for the unit cell can be obtained

as

$$\begin{aligned}
 v|_{x=0} = w|_{x=0} = 0 & \quad \text{and} \quad v|_{x=b_x} = w|_{x=b_x} = 0 \\
 v|_{y=0} = 0 & \quad \text{and} \quad v|_{y=b_y} = 0 \\
 u|_{z=0} = v|_{z=0} = 0 & \quad \text{and} \quad u|_{z=b_z} = b_z \gamma_{xz}^0 \quad \& \quad v|_{z=b_z} = 0.
 \end{aligned} \tag{33}$$

4.6 Under τ_{xy}^0

The corresponding boundary conditions are

$$\begin{aligned}
 v|_{x=0} = w|_{x=0} = 0 & \quad \text{and} \quad v|_{x=b_x} = w|_{x=b_x} = 0 \\
 u|_{y=0} = w|_{y=0} = 0 & \quad \text{and} \quad u|_{y=b_y} = b_y \gamma_{xy}^0 \quad \& \quad w|_{y=b_y} = 0 \\
 w|_{z=0} = 0 & \quad \text{and} \quad w|_{z=b_z} = 0.
 \end{aligned} \tag{34}$$

It has been shown in this section that with reflectional symmetries additional to translational ones, unit cells can be formulated with rather conventional boundary conditions (20) for loading in terms of microscopic stress σ_x^0 , σ_y^0 or σ_z^0 , (32) for τ_{yz}^0 , (33) τ_{zx}^0 and (34) for τ_{xy}^0 which do not involve equations associating the displacements on opposite sides of the unit cell. The price to pay is the fact that under different loading conditions, different boundary conditions may have to be employed.

5 2-D problems

The 3-D presentation of boundary conditions can be easily degenerated to 2-D problems in the y - z plane, for argument's sake, including plane stress, plane strain, generalised plane strain problem and anticlastic problem. They apply to the rectangular unit cell as obtained from the hexagonal layout as shown in Fig. 6 as well as to the square one as from Fig. 3. They are given as follows without detailed derivations.

5.1 Under σ_y^0 and σ_z^0

When a 2-D unit cell, in the y - z plane, is subjected to macroscopic stresses σ_y^0 or σ_z^0 , the boundary conditions are the same as below

$$v|_{y=0} = 0 \quad \text{and} \quad v|_{y=b_y} = b_y \epsilon_y^0$$

$$w|_{z=0} = 0 \quad \text{and} \quad w|_{z=b_z} = b_z \varepsilon_z^0. \quad (35)$$

The difference is a concentrated force needs to be imposed to the extra d.o.f. ε_y^0 or ε_z^0 to achieve these two macroscopically uniaxial stress states, respectively.

5.2 Under τ_{yz}^0

The boundary conditions for a unit cell under macroscopically uniaxial shear stress τ_{yz}^0 in the y - z plane are as follows

$$\begin{aligned} w|_{y=0} = 0 & \quad \text{and} \quad w|_{y=b_y} = 0 \\ v|_{z=0} = 0 & \quad \text{and} \quad v|_{z=b_z} = b_z \gamma_{yz}^0 \end{aligned} \quad (36)$$

A concentrated force at the extra d.o.f. γ_{yz}^0 delivers the macroscopically uniaxial shear stress states.

As on boundary $y=0$, displacement v is not constrained in any form and there is no restriction whether the side should remain straight after deformation. The same applies to all other sides.

5.3 Generalised plane strain problem and macroscopically uniaxial stress state σ_x^0

For generalise plane strain problems, an extra d.o.f. ε_x^0 , in addition to ε_y^0 , ε_z^0 and γ_{yz}^0 , has to be introduced, which can be dealt with in the same manner as other extra d.o.f.'s corresponding to macroscopic strains. This extra d.o.f. should be left free when applying macroscopically uniaxial stress states σ_y^0 and σ_z^0 but constrained for τ_{yz}^0 as τ_{yz}^0 is antisymmetric under the reflectional symmetry while ε_x^0 is symmetric. It should be pointed out that neither plane stress nor plane strain is capable of reproducing the macroscopically effective uniaxial stress states under which effective properties are measured experimentally according to their definitions. For UD composites, the generalised plane strain problem is the only 2-D formulation which is capable of achieving macroscopically effective uniaxial stress state.

When applying a macroscopically uniaxial stress state σ_x^0 , the boundary conditions are the same as in (35). However, the concentrated force should be applied to the extra d.o.f. ε_x^0 while leaving ε_y^0 and ε_z^0 free. The nodal displacements at these extra d.o.f.'s ε_x^0 , ε_y^0 and ε_z^0 give the macroscopic strains directly, which can be used to work out the effect Young's modulus in x -direction and

Poisson ratios associated with x direction.

5.4 Under τ_{xz}^0 and τ_{xy}^0 in an anticlastic problem

The anticlastic problem in the y - z plane involves only one displacement u . When macroscopically uniaxial shear stress τ_{xz}^0 is applied, from subsection 4.5, the boundary conditions for the unit cell can be obtained as

$$u|_{z=0} = 0 \quad \text{and} \quad u|_{z=b_z} = b_z \gamma_{xz}^0 \quad (37)$$

while edges $y=0$ and $y=b_y$ are left free. A concentrate force can be applied to the extra d.o.f. γ_{xz}^0 to deliver a macroscopically uniaxial stress state τ_{xz}^0 and the nodal displacement at γ_{xz}^0 gives this macroscopic strain directly.

Similar arguments apply to the macroscopically uniaxial stress state τ_{xy}^0 and from subsection 4.6, the corresponding boundary conditions are obtained

$$u|_{y=0} = 0 \quad \text{and} \quad u|_{y=b_y} = b_y \gamma_{xy}^0 \quad (38)$$

while edges $z=0$ and $z=b_z$ are left free.

6 Deformation of the sides of unit cells

As examples of the applications of the boundary conditions derived above, several examples of unit cells have been analysed. Particular attention in this section will be paid to the deformation of the sides of the unit cell, which do not always remain flat/straight after deformation, when boundary conditions have been derived and imposed rigorously.

6.1 3-D unit cell for particle reinforced composites with simple cubic particle packing

A unit cell for simple cubic packing was presented in [3] and a mesh was generated there with a spherical geometry for particle and appropriate constituent material properties in the examples. The same will be adapted and the reflectional symmetries in the unit cell as presented in [3] will be made use of further. As a result, only an octant is required as the unit cell for the present analysis.

Without losing generality, only macroscopically uniaxial stress states σ_x^0 and τ_{yz}^0 are examined here.

The boundary conditions are as given in (20) and (32), respectively.

Under macroscopically uniaxial stress state σ_x^0 , the results are identical to the results as shown in [3] when the corresponding octant is taken out of the unit cell in [3] for comparison. This should not undermine the unit cells formulated in [3] as the present one are only applicable if the particle possesses required reflectional symmetries. It can be noted that all sides remain flat after deformation. This is imposed by the boundary conditions as in (20). The same is expected when the unit cell is under other macroscopic stress σ_y^0 or σ_z^0 or any combination of σ_x^0 , σ_y^0 and σ_z^0 .

When the unit cell is subjected to a macroscopically uniaxial shear τ_{yz}^0 , the von Mises stress contour plot is shown in Fig. 7. The results obtained here also agree identically with those in [3], although the corresponding contour plot was not shown in [3]. According to boundary conditions as given in (32), only the x -faces, i.e., $x=0$ and $x=b_x$, have to remain flat after deformation, while the boundary conditions on the remaining faces impose no restriction in this regard. As a result, the remaining two pairs of faces, i.e. y -faces and z -faces, do not have to remain flat. Fig. 7 illustrated the curved trend for these two faces. The curvature of these faces reduces as the disparity of properties between the particle and the matrix reduces. In fact, flat faces are expected when the particle and matrix share identical properties. The same observation applies to the unit cell when it is subjected to either of the two remaining macroscopic stresses, τ_{zx}^0 and τ_{xy}^0 . The only difference is that the faces remaining flat after deformation become y -faces and z -faces instead, respectively, while other faces warp after deformation, in general.

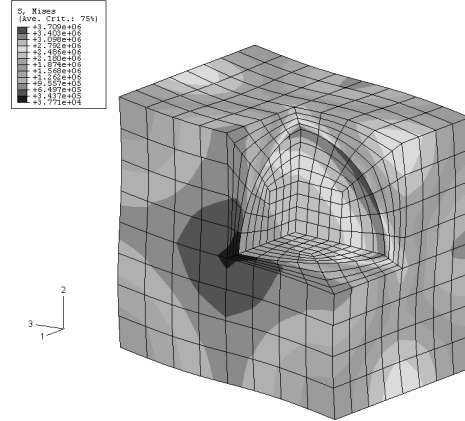

Figure 7 Deformation of a unit cell for particle reinforced composite with a simple cubic packing

It should be noted that while (20) applies to any or any combination of macroscopic direct stress state, (32) is only applicable to τ_{yz}^0 . Boundary conditions (33) and (34) have to be used for τ_{zx}^0 and τ_{xy}^0 , respectively. One has to turn back to the unit cell as proposed in [3] if any combination of τ_{yz}^0 ,

τ_{zx}^0 and τ_{xy}^0 has to be applied.

6.2 2-D unit cell for UD fibre reinforced composites with square fibre packing

Applying boundary conditions as given in Section 5 above, 2-D unit cells can be analysed pertinent to UD fibre reinforced composites with circular fibre cross-section. The examples here correspond to the cases as published in [2]. However, unit cells of smaller sizes have been used here, taking advantage of reflectional symmetries present in the problem. As in [2], generalise plane strain problem applies to the problem for macroscopic stress states σ_x^0 , σ_y^0 , σ_z^0 and τ_{yz}^0 , x -axis being along the fibre while the anticlastic problem for macroscopic stress states τ_{zx}^0 and τ_{xy}^0 can be analysed using heat transfer as an analogy to avoid 3-D modelling.

Once again, perfect agreement in results can be obtained between the unit cells presented here and those in [1,2] for both square packing and hexagonal packing. Similar observations to those in their 3-D counterparts in the previous subsection can be made on the deformation of the sides of the unit cells. Under direct macroscopic stress states, all the sides of a square unit cell remain straight after deformation. However, under other loading conditions or for hexagonal unit cells, sides may not remain straight after deformation as shown in Fig.8 unless the fibre bears the same elastic properties as the matrix. For macroscopic stress states τ_{zx}^0 and τ_{xy}^0 , the sides may look straight from the perspective along the x -axis (fibre direction) but the y - z plane itself warps into a curved surface. The sides are in fact curved in space.

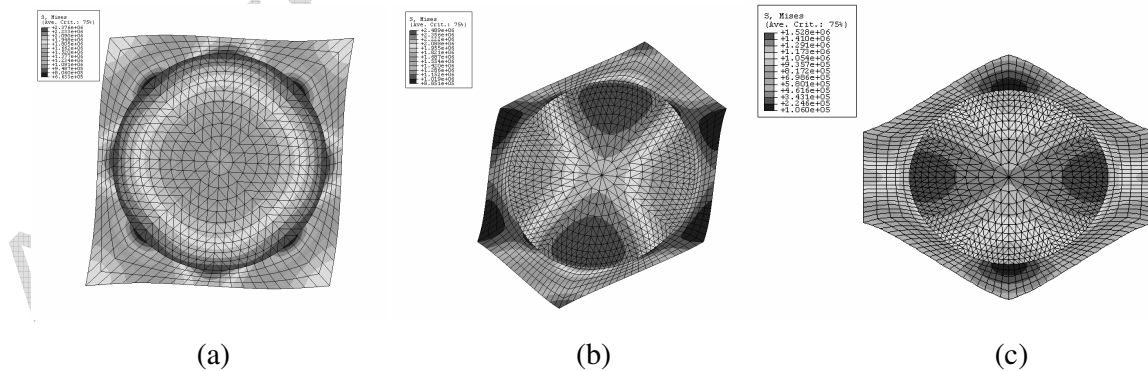

Figure 8 Curved edges in deformed unit cells (a) square unit cell under macroscopic transverse shear τ_{yz}^0 (1MPa) (b) hexagonal unit cell under macroscopic transverse shear τ_{yz}^0 (1MPa) (c) hexagonal unit cell under macroscopic transverse tension σ_y^0 (1MPa)

The objective of the examples in Figs. 7 and 8 is to demonstrate that the sides of the properly

established unit cells do not always remain flat/straight after deformation. Intuitively formulated unit cells assuming flat/straight sides after deformation are incorrect in general. The underlying principle for the formulation of unit cells is the principle of symmetries, while intuition is often subject to limitations. Once the symmetries present in the microstructure in the material have been made proper use of, correct unit cells can be obtained. The boundary conditions derived in this way will not result in any boundary effect as presented in [4]. In fact, if one analysis an assembly of cells, e.g. the one as shown in Fig. 3b, the results obtained will be exactly the same as those from the analysis of that in Fig. 3c, provided that the boundary conditions have been imposed correctly in both cases.

7 Effects of microstructures implied by different unit cells

The unit cells as sketched in Fig. 2b and 3c bear the same geometry but are subjected to different boundary conditions. They are therefore different unit cells. The differences do not always result in different results, especially when the inclusions (fibre or particle) possess sufficient reflectional symmetries. However, it could be badly wrong if one is used blindly in place of the other, in particular, when the inclusions do not show the required symmetries. The purpose of this section is to illustrate such differences as nothing in the literature seems to suggest that the implications have been fully recognised.

Assume a 2-D microstructure involving inclusions of an elliptical cross-section inclined at 30° . The ellipse is of 2:1 aspect ratio and occupies a volume fraction of 40%. The elastic properties of the inclusion and the matrix are assumed as listed in Table 1. The same mesh as shown in Fig. 9 will be used for both unit cells corresponding to microstructures as shown in Fig. 2 and 3, respectively. The von Mises stress contour plots at deformed configurations under macroscopic stress states σ_z^0 and τ_{yz}^0 ($=1\text{MPa}$) are presented and compared in Fig. 10. It is obvious that differently assumed microstructures as implied by the two different unit cells result in different stress distributions microscopically. The differences are even more pronounced when effective properties are extracted from these unit cells and compared as listed in Table 2 where properties η are defined as the ratio of shear strain γ to the direct strain ϵ when the unit cell is subjected to a macroscopically uniaxial direct stress state σ and μ as the ratio of shear strain γ to shear strain γ when the unit cell is subjected to a macroscopically pure shear stress state τ [12]. These properties in the material's principle axis vanish for orthotropic material, as is the case for the unit cell corresponding to Fig. 3c. Material represented by the unit cell corresponding to Fig. 2b is not orthotropic but monoclinic in

general relative to the y - z axes as shown in Fig. 9. The differences as illustrated here will disappear when the ellipse is replaced by a circle but this is not a sufficient reason for ignoring the differences. When a unit cell is used, the user ought to be clear about the implications of the unit cell adopted on the microstructure of the materials, e.g. the one in Fig. 2 or the one in Fig. 3, which are apparently different enough from each other.

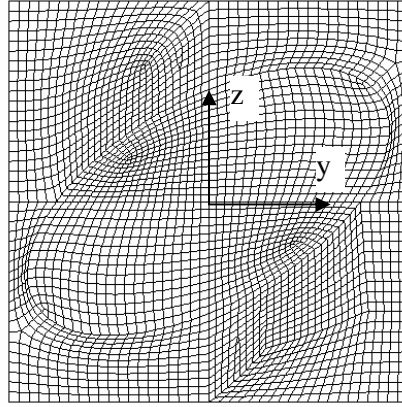

Fig. 9 Mesh for the unit cell with an reinforcement of an elliptical cross-section

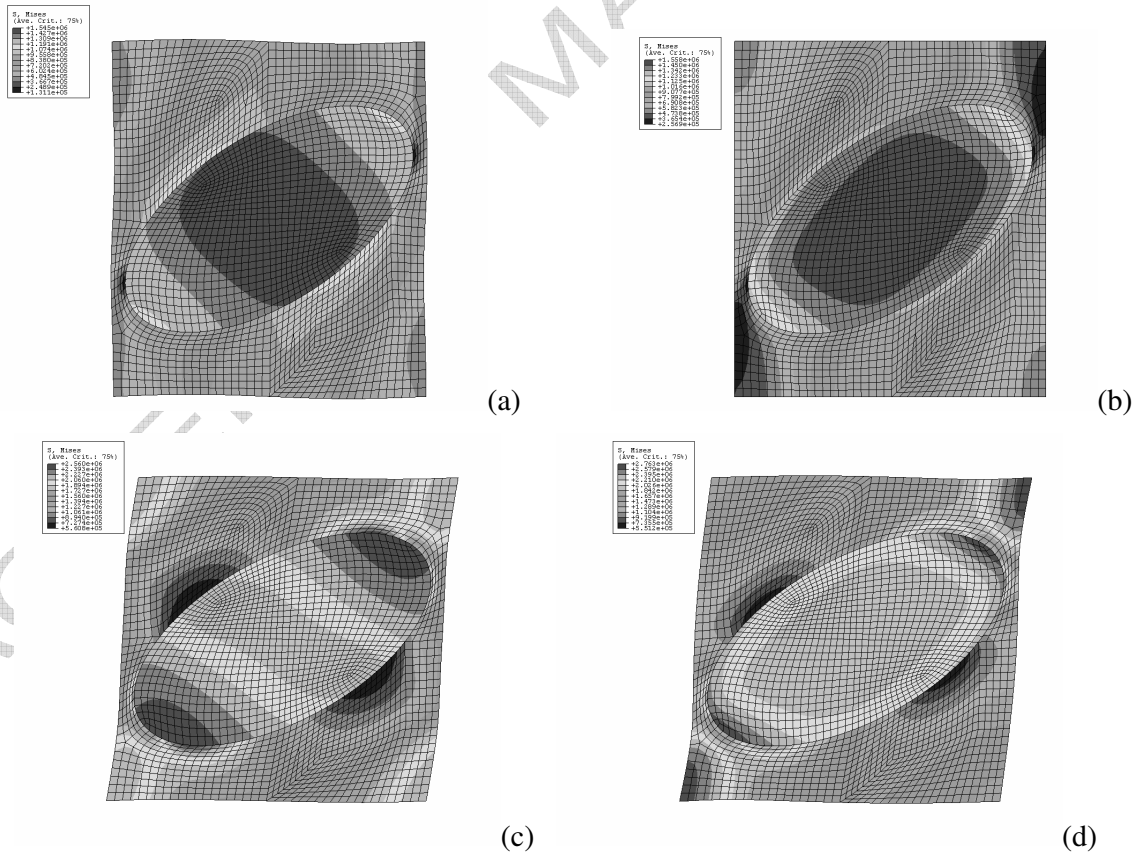

Figure 10 Defromation and von Mises stress contour plots (a) unit cell corresponding to Fig. 2b under σ_z^0 (b) unit cell corresponding to Fig. 3c under σ_z^0 (c) unit cell corresponding to Fig. 2b under τ_{yz}^0 (d) unit cell corresponding to Fig. 3c under τ_{yz}^0

Table 1 Properties of the constituents for the unit cells

Properties	Inclusion	Matrix
E	10 GPa	1 GPa
ν	0.2	0.3

Table 2 Effective properties corresponding to the unit cells

Effective properties	Unit cell in the sense of Fig. 2b	Unit cell in the sense of Fig. 3c
E_1	4.603 GPa	4.605 GPa
E_2	2.183 GPa	2.372 GPa
E_3	1.864 GPa	1.890 GPa
G_{23}	0.6803 GPa	0.6710 GPa
G_{13}	0.7016 GPa	0.7144 GPa
G_{12}	0.9180 GPa	1.0288 GPa
ν_3	0.3586	0.3663
ν_3	0.2606	0.2612
ν_2	0.2436	0.2378
η_4	0.01377	0
η_4	-0.08768	0
η_4	-0.04289	0
β_6	-0.1143	0

8 Conclusions

Unit cells for micromechanical analyses have to be introduced with due consideration of the microstructures implied by the unit cell. Boundary conditions for unit cells representing microstructures of periodic patterns should follow entirely from the symmetries present in the microstructure the unit cell represents rather than from one's intuition. The symmetries include translations, reflections and rotations. Using translations alone leads to boundary conditions in form of equations relating displacements on opposite sides of the boundary of the unit cell. Further use of reflection symmetries, if they exist, can avoid such equation boundary conditions, making the application of boundary conditions easier. However, users must be aware of the differences in the microstructures implied by the boundary conditions for the unit cell. Although unit cells may look

identical geometrically, different boundary conditions imposed would associate the unit cell with rather different microstructures. It has been illustrated in this paper that such differences in the microstructures may result in rather different effective properties of the composites represented by the unit cells.

References

- [1] Li S. On the unit cell for micromechanical analysis of fibre-reinforced composites. *Proc Roy Soc Lond A* 1999; **455**:815-838
- [2] Li S. General unit cells for micromechanical analyses of unidirectional composites. *Composites A*, 2001; **32**:815-826
- [3] Li S, Wongsto A. Unit cells for micromechanical analyses of particle reinforced composites. *Mech Mater* 2004; **36**:543-572
- [4] Fang Z, Yan C, Sun W. A. Shokoufandeh and W. Regli, Homogenization of heterogeneous tissue scaffold: A comparison of mechanics, asymptotic homogenization, and finite element approach. *Applied Bionics and Biomechanics* 2005; **2**:17-29
- [5] Peng X, Cao J. A dual homogenisation and finite element approach for material characterisation of textile composites. *Composites, Part B* 2002; **33**:45-56
- [6] Llorca J, Needleman A, Suresh S. An analysis of the effects of matrix void growth on deformation and ductility in metal-ceramic composites. *Acta Metall Mater* 1991; **39**:2317-2335
- [7] Adams DF, Crane DA. Finite element micromechanical analysis of a unidirectional composite including longitudinal shear loading. *Computers and Structures* 1984; **18**:1153-1165
- [8] Nedele MR, Wisnom MR. Finite element micromechanical modelling of a unidirectional composite subject to axial shear loading. *Composites* 1994; **25**:263-272
- [9] Zahl DB, Schmauder S, McMeeking RM. Transverse strength of metal matrix composites reinforced with strongly bonded continuous fibres in regular arrangement. *Acta Metall Mater* 1994; **42**:2983-2997
- [10] Yeh JR. Effect of interface on the transverse properties of composites. *Int J Solids Structures* 1992; **29**:2493-2502
- [11] Aitharaju VR, Averill RC. Three-dimensional properties of woven-fabric composites. *Composites Science and Technology* 1999; **59**:1901-1911
- [12] Lekhniskii SG. *Theory of Elasticity of an Anisotropic Elastic Body*. San Francisco: Holden Day, 1963