



HAL
open science

Influence of drapability by using stitching technology to reduce fabric deformation and shear during thermoforming

P. Molnár, A. Ogale, R. Lahr, P. Mitschang

► To cite this version:

P. Molnár, A. Ogale, R. Lahr, P. Mitschang. Influence of drapability by using stitching technology to reduce fabric deformation and shear during thermoforming. *Composites Science and Technology*, 2009, 67 (15-16), pp.3386. 10.1016/j.compscitech.2007.03.022 . hal-00521253

HAL Id: hal-00521253

<https://hal.science/hal-00521253>

Submitted on 27 Sep 2010

HAL is a multi-disciplinary open access archive for the deposit and dissemination of scientific research documents, whether they are published or not. The documents may come from teaching and research institutions in France or abroad, or from public or private research centers.

L'archive ouverte pluridisciplinaire **HAL**, est destinée au dépôt et à la diffusion de documents scientifiques de niveau recherche, publiés ou non, émanant des établissements d'enseignement et de recherche français ou étrangers, des laboratoires publics ou privés.

Accepted Manuscript

Influence of drapability by using stitching technology to reduce fabric deformation and shear during thermoforming

P. Molnár, A. Ogale, R. Lahr, P. Mitschang

PII: S0266-3538(07)00128-5
DOI: [10.1016/j.compscitech.2007.03.022](https://doi.org/10.1016/j.compscitech.2007.03.022)
Reference: CSTE 3639

To appear in: *Composites Science and Technology*

Received Date: 7 December 2006
Revised Date: 2 March 2007
Accepted Date: 18 March 2007

Please cite this article as: Molnár, P., Ogale, A., Lahr, R., Mitschang, P., Influence of drapability by using stitching technology to reduce fabric deformation and shear during thermoforming, *Composites Science and Technology* (2007), doi: [10.1016/j.compscitech.2007.03.022](https://doi.org/10.1016/j.compscitech.2007.03.022)

This is a PDF file of an unedited manuscript that has been accepted for publication. As a service to our customers we are providing this early version of the manuscript. The manuscript will undergo copyediting, typesetting, and review of the resulting proof before it is published in its final form. Please note that during the production process errors may be discovered which could affect the content, and all legal disclaimers that apply to the journal pertain.



Influence of drapability by using stitching technology to reduce fabric deformation and shear during thermoforming

Molnár, P., Ogale, A., Lahr, R., and Mitschang, P.

Institut für Verbundwerkstoffe GmbH, Erwin-Schrödinger-Straße 58,
67663 Kaiserslautern, Germany

Abstract

Forming of woven fabric into a complex shape involves shear deformation of the fabric elements (warp and weft). Various researchers investigated the shear deformation during the manufacturing of thermoplastic composites (TPC) based on the hemispherical geometry, where the highly deformed edges and corners are considered as a waste. In many applications the complete formed geometry including areas around the curvature has to be used. A new idea to influence the deformation behavior of woven fabric by incorporated seams at localized sections is presented in this paper. The study is based on the photographic analysis of dry sewn preforms and thermoplastic matrix (PA12) impregnated laminates, before and after the deformation. The seams applied at the highly deformable and predefined zones help to reduce fabric shearing or to transfer the shear forces into the unsheared areas during the thermoforming process. The intensity of reduction in the fabric shear depends on the type of the sewn geometry. The results obtained can be applied in the part design, the preform engineering, and the positioning of stitches.

Key words: E: thermoforming, A: preform, E: sewing, B: shear deformation, A: TPC

1. Introduction

Over the past several years, many studies have been conducted on the material behavior and the forming process of TPCs. Many investigations of the thermoplastic composites are based on the thermoformed hemispherical geometry, where the highly deformed edges and corners are considered as a waste. Nevertheless many applications the complete formed geometry including areas around the curvature has to be used. One of these applications is the creased thermoplastic composite flange for aircraft vertical tails (Figure 1). This paper concentrates on the deformation behavior of laminate zones around of hemisphere. It has been observed that irrespective of the underlying weave geometry, the fabric undergoes nearly pure shear deformation during draping, with the constituent tows rotating with a material specific resistance at the crossover points [1, 2, 3]. The drape behavior is, therefore, often simply modeled by mapping these crossover points over the curved mold shape [4, 5]. Material test methods for woven fabrics reported in the literature include bi-axial tensile tests, bias extension tests, and shear frame tests [1, 6 -16]. These test methods are restricted to components with uniformly curved surfaces.

The aim of the present work is to provide the basis for influencing the fiber movement at the warp-weft crossover points in the sheared zones by means of local stitching. At first, measurements of draped fabric over a dome shape component were evaluated and compared with the pre-trial predictions. Details of the fabric deformation were analyzed and it has been observed that the deformation varies according to the symmetry of shear, which is also supported by literature [17]. Consequently, various tests on fabric specimens with asymmetric and symmetric stitching patterns were performed. Optimization of the seam direction, seam location, and amount of stitches was the next step of experimentation. During the forming operation, a large angular variation between

weft and warp yarns was visible. Hence, the main focus was on the testing of shear behavior of woven composites in the dry preform and impregnated laminate stage.

2. Materials

Two layers of Kevlar® and glass fiber mixed (24 % Kevlar and 76 % glass) 2/2 twill woven fabric with 257 g/m² area weight, 6.7 ends/cm, and 6.7 picks/cm were used for the tests. Figure 2 shows the used fabric with warp and weft direction and sewn preform sample with glass thread. The preforms were manufactured using a programmable gantry stitching machine (Figure 3a). The actual frame size was 600 mm x 1500 mm. The size of the individual preforms was 250 mm x 250 mm. Thus, 10 preforms were stitched with this set up at once.

In order to investigate the influence of position and amount of stitches, six different contours were tested and Table 1 shows the investigated sewing contours. Two of the contours were chosen for the further investigations. The sewing thread used was a 68 tex glass fiber twisted thread (Colimeta MN 30, supplier: Culimeta Textilglas-Technologie GmbH & Co. KG). The stitch length was 3 mm for all preforms and the stitch frequency was 500 stitches per minute. Unstitched samples were used as a reference for original shear deformation after stamping. A set of preforms with the same contour were used for dry testing and another set was impregnated in an autoclave (Figure 3b) by using a polyamide 12 (PA12) thermoplastic matrix.

3. Testing and results

The shear deformation trials of the dry preform were performed on a laboratory scale instrument which consists of two PMMA plates with a cavity in the center. The inner diameter of the cavity is slightly higher than the outer diameter of the used stamping tool

(hemisphere). Figure 4 shows a schematic diagram of the testing set-up. Due to the transparent PMMA plate, shear deformation of the preform can easily be noted and photographed for further analysis. The stamp diameter was 60 mm and the testing speed was 720 mm/s.

The impregnated samples were thermoformed on the industrial scale press with the same size of stamp as used for the dry textile deformation. Figure 5 shows the schematic a) and actual set-up b) of the thermoforming process. After cooling the thermoformed laminates were also photographed.

After the photos were taken and prepared, the shear deformation in dry preforms and thermoformed laminates were analyzed by using an image processing tool. Starting from the highly sheared zone (boundary of the hemisphere) to the outer edge of the preform, the angle between warp and weft threads was measured. Data from the two corners of the sheared zones 315° , 135° were gathered and documented. Four samples per sewing geometry were tested, i.e. data from total 8 corners were used for further investigations.

3.1 Initial test results

It has been observed that the preforms stitched with $0^\circ/90^\circ$ direction seam (Type D) shows lesser warp-weft shear at $\pm 45^\circ$ zones. Cross stitched preforms (Type B) show highest shear deformation in all preforms. Here, the shearing at $\pm 45^\circ$ zones is very acute and therefore, blocking of warp and weft roving may occur. If the shear deformation is too strong the warp and weft rovings will buckle in that region. Because the circular (Type E) and the $0^\circ/90^\circ$ direction (Type D) sewn preforms showed the most positive influence (the achieved highest shear angle values), thus, these have been taken as a

key baseline. Intensive studies were carried out on the combination of cross stitches and circular stitches. Segmental-circular stitches were placed on the fabric to manufacture specimens with $0^{\circ}/90^{\circ}$ (Type F) and $\pm 45^{\circ}$ (Type G). Here, $\pm 45^{\circ}$ segment stitched preforms (Type G) show lower impact on the improvement in drapability and reduction in the shear deformation. The tests results based on Type G shows less significant influence of stitching in case of laminates too. Here, the major shear sensitive zone has been stitched which causes only a minimal positive influence on the shearing fibers. The $0^{\circ}/90^{\circ}$ segment stitched preforms and laminates (Type F) shows higher impact. Figure 6 shows a graphical presentation of the shear behavior of the $0^{\circ}/90^{\circ}$ segment (Type F) stitched dry preforms and laminates in comparison with unstitched samples (Type A). The reason for this behavior can be the restricted shifting of shear force to the $0^{\circ}/90^{\circ}$ rovings because the fibers in the unsheared zone ($0^{\circ}/90^{\circ}$) have been arrested. The stitch acts as a blocker which stops the cross point shifting of warp and weft. As a reaction of this, warp and weft rovings in the $\pm 45^{\circ}$ region, which are more sensitive to shear, must buckle during the forming process.

Type F has great influence on the shear deformation of the laminates too.

This stitch pattern does not allow the shifting of the fibers from the 0° and 90° to the $\pm 45^{\circ}$ direction. As a result of this, fibers shear in the $\pm 45^{\circ}$ but the buckling is eliminated locally by the stitching and globally by the fiber matrix bonding. It is easy to observe that the arresting function of the Type F segment stitch outside of the deformation zone has great influence on the shearing inside the deformation zone. So the total shear deformation under $\pm 45^{\circ}$ in Type F sample is much lower in all measurement points. In this case 5 points of the four sheared zones are measured. The position of the measurement points are shown in Figure 6. The standard deviations of the measured values on the Type F specimen were in all points less than $\pm 2^{\circ}$. Figure 6 a.) and b.)

show, that the change of the shear angles between the stitched and unstitched samples is different for laminates and dry preforms. This effect is caused by the additional arresting function of the polymer matrix in the laminate. Figure 6 b.) shows a parallel displacement of the trend lines based on the laminate effect.. This global arrester effect of the matrix can not be increased by a high matrix viscosity. If the specimens were thermoformed below the melting temperature of the polymer matrix, for instance, $T_m - 20K$, the high viscous matrix blocks the warp-weft shearing in the laminate completely. This effect is shown in Figure 7. In this case the built deformation stress causes wrinkles in the structure.

3.2 Final test results

Further studies concentrate on the optimization of number and position of segments. For this analysis, preforms stitched in 1) 0° (Type H), 2) 0° and 90° (Type I), 3) 0° and 180° (Type K), and 4) 0° , 90° and 270° (Type L) segmental contours were manufactured and laminated with a PA 12 matrix (Table 2.).

As reference specimens the shear angles on the unstitched laminates were measured (Figure 8). Figure 9 shows the measured points in the structure related to the fiber orientation of the woven fabric.

The shear angle values of the stitched laminates can be comparing with these results. Additionally with help of the unstitched specimens the stamp and clamp were adjusted to assure the correct set up of the tool. In case of the correct set up the four segments of the unstitched laminate must show identical shear behavior. Figure 9 shows the proof of this symmetrical shear behavior.

The specimens with Type H, K, and L contours show no relevant results, but especially at the $270^{\circ}/0^{\circ}$ segment positioned stitching (Type I), the effect of the seam on the shear angle can clearly be observed (Figure 10). The graph shows the shear angle measured at the unstitched (90° - 180° zone, right bottom) and the stitched (270° - 0° zone, left top) zones. The angle between warp and weft fibers in the stitched zone (270° - 0°) are in all measurement points considerably lower than the angles in the unstitched area.

The Figure 11 shows the mean shear angle values of the Type I specimen in comparison to the unstitched specimens. The results indicate clearly that the local drapability capacity as a function of possible free shear angle can be affected by local stitching.

As the next step 12 different stitching patterns were positioned in the same zones, as in case of the Type I specimen (in the 270° and 0° directions). Based on the results of these investigations the best 6 pattern were chosen for the further investigations. These patterns have had the most considerable influence on the shear behavior of the thermoformed laminates (Table 3). Table 4 shows the predicted fiber movement in the zones near to the stitched segments. While the structure assumes the hemispherical shape during the thermoforming, the warp and weft fibers move into the center direction. The coupled crossover points through stitching pull the nearby fibers from the sheared zones to the stitched area and reduces the shearing between the warp and weft fibers in the critical zone in the 90° - 180° area.

The highest positive influences on the shear deformation had the patterns Type 631, 635, and 637. Beside this the pattern type 637 (Table 3) has a more simple structure and closed stitch line, therefore, Type 637 can be stitched cost effectively without cutting operations. Often different problems during the stitching process occur by cutting and restart of stitching. Therefore necessary to develop a closed and simple stitching pattern

with reduced stitch number. Figure 12 shows the measured shear angle values on the specimen with Type 637 pattern compared to the unstitched values.

These six patterns (Table 3) were used not only with glass yarn but with 64 tex PET (Saba C50; supplier: Amann & Söhne GmbH & Co. KG) and 65 tex aramid (Nomex No. 50 7627; supplier Amann & Söhne GmbH & Co. KG) yarns too. These polymers have higher melting temperatures as the matrix material (PA12). Therefore, they can be used as a blocker fiber for the laminates. The prediction was that the polymer yarns with higher elongation also modify the shear deformation, but built not as large stitch holes as the glass stitching yarn. Additionally the glass yarn has different problems by cutting and stitching on.

The polymer yarns have nearly the same effect as the glass yarn, additionally no relevant differences between the influence of the aramid and PET yarns were found, but the PET yarn has better stitching behavior (Figure13). Therefore, it can be suggested to use PET yarn to reduce the manufacturing costs during the performing.

4 Conclusions

The local stitching influences the overall drapability and shear deformation of the laminate. The influence of the stitching on the drapability and shear angle is lower on thermoformed laminate than on the dry preform. Furthermore, the fiber-matrix bonding in the laminate blocks the warp and weft fiber movement and can be considered as a global structural arrester. Stitches applied in shear area influence the deformation lesser than the stitches applied outside. The seams can be considered for locking the deformation sensitive area (local blocking), thus, the combination of stitching and matrix bonding allows a maximum in shear angle reduction during the thermoforming. Based on the result respectively the different stitch patterns and yarns were collected in a

database and built the base for further investigations including an adapted finite element based draping simulation.

5 Acknowledgement

The authors like to thank the German research foundation (DFG) for supporting the project “Drapierbeeinflussung beim Thermoformen durch konfektionierte Textilstrukturen” (Mi 647/11-1).

6. References

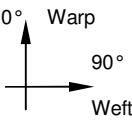
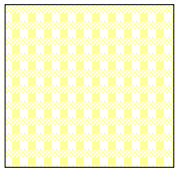
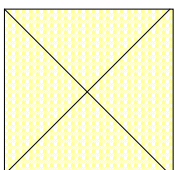
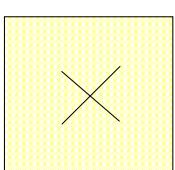
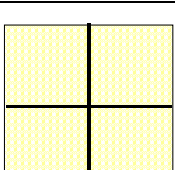
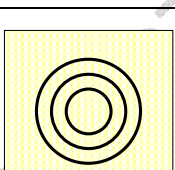
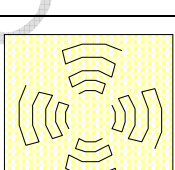

- 1 Potter K D. The Influence of accurate stretch data for reinforcements on the production of complex structural mouldings Part I: Deformation of aligned sheets and fabrics. *Composites* 1979; 161-167.
- 2 Long A C, Souter B J, Robitaille F, Rudd C D Effects of fibre architecture on reinforcement fabric deformation *Plastics, Rubber and Composites*, Volume 31, Number 2, February 2002, pp. 87-97(11)
- 3 Lomov, S V, Verpoest I Model of shear of woven fabric and parametric description of shear resistance of glass woven reinforcements. *Composites Science and Technology*, 2006; 66: 919-933
- 4 Van West B P, and Luby S C. Fabric draping simulation in composites manufacturing part I and II, *J. Adv. Materials* 1997: 29-41.
- 5 Boisse P, Borr M, Buet M, and Cherouat. A. Finite element simulations of textile composite forming including the biaxial fabric behavior. *Composites Part B-Engineering* 1997; 28: 453-464.
- 6 Nowacki J, Fujiwara J, Mitschang P, and Neitzel M. Deep drawing of fabric reinforced thermoplastics: Maximum drawing depth and mechanism of wrinkle formation. *Polymers and Polymer Composites* 1998; 6 / 4: 215-222.
- 7 Potter K D. Influence of the detailed structure of two variants of non-crimped carbon fabric on the drape properties. *Advanced Composites Letters* 2002; 11: 285-292.
- 8 Buckenham P. Bias-extension measurements on woven fabrics. *Journal of the Textile Institute* 1997; 88: 33-40.

- 9 McBride T M, and Chen J. Unit-cell geometry in plain-weave fabrics during shear deformation. *Composites Science and Technology* 1997; 57: 345–351.
- 10 Chen J, Lussier D S, Cao J, and Peng X Q. Materials characterization methods and material models for stamping of plain woven composites. *International Journal of Forming Processes* 2002; 4: (3–4).
- 11 McGuinness G B, and Ó Brádaigh C M. Characterization of thermoplastic composite melts in rhombus-shear: the picture frame experiment. *Composites Part A* 1998; 29: 115–132.
- 12 Nguyen M, Herszberg I, and Paton R. The shear properties of woven carbon fabric. *Composite Structures* 1999; 47: 767–779.
- 13 Lussier D, Chen J. Material characterization of woven fabrics for thermo-forming of composites. In proceedings of the 15th Technical Conference of American Society for Composites, College Station 2000; TX: 301–310.
- 14 Cherif C., Wulfhorst B. Analyse des dreidimensionalen Deformationsverhaltens von multiaxialen Gelegen und Verstärkungsgeweben. *Aachener Textiltagung* Nov. 1999; *DWI Reports* 2000/123, S. 77-83
- 15 Cherif C., Wulfhorst B. Deformationsverhalten von multiaxialen Verstärkungstextilien für den Einsatz in Composites. *Technische Textilien* 43 (2000), H.1, S. 58-60
- 16 Crookston, J J, Long, A C, Jones, I A A summary review of mechanical properties prediction methods for textile reinforced polymer composites *Proceedings of the I*

MECH E Part L Journal of Materials:Design and Applications, Number L2, April 2005, pp. 91-109(19)

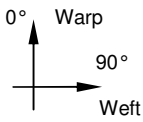
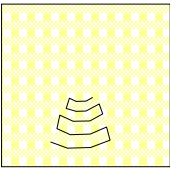
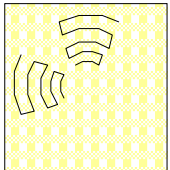
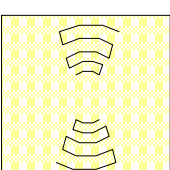
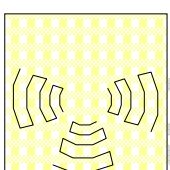
- 17 Sharma S B, and Sutcliffe M P F. Draping of woven composites over irregular surfaces. Proc. of Int. Conf. on Composite Materials ICCM-13, 25-29 June 2001, Beijing, China.

Table 1: Types of contours chosen for preforming

Type		Type of contour (250x250mm)	Test results (type of effect)		Selected for final trials
			Influence on preform shear	Influence on laminata shear	
A		Unstitched	-	-	Yes
B		Cross stitching	+++ (negative)	++ (negative)	No
C		Segmented local cross stitching at center	--	--	No
D		0°/90° stitching	--	+	No
E		Circular stitching	+	+	No
F		Segmented circle	+	+++ (positive)	Yes With 1, 2, 3, and 4 segments
G		Segmented circle	+++ (positive)	+	No

+ considerable influence, ++ high influence, +++ very high influence, - low influence, -- no influence

Table 2 Types of contours for optimization of the segment

Type		Type of contour (250x250mm)	Test results	
			Influence on preform shear	Influence on laminates shear
H		180°	-	-
I		0° and 270°	+++	++
K		180° and 0°	--	--
L		180°, 270°, and 90°	--	+

+ considerable influence, ++ high influence, +++ very high influence, - low influence, -- no influence

Table 3: Developed stitching patterns for the final investigations

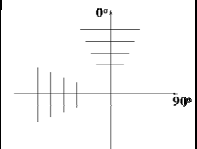
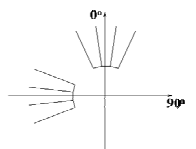
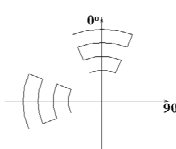
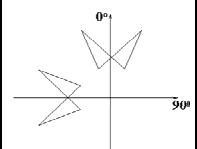
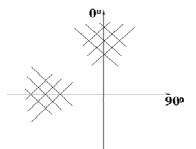
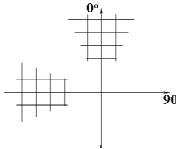
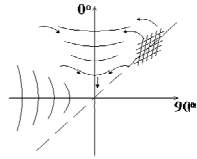
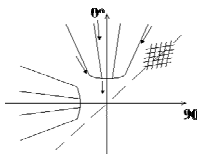
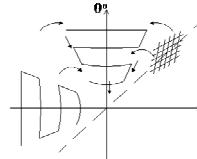
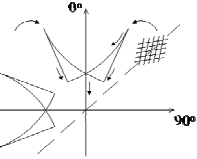
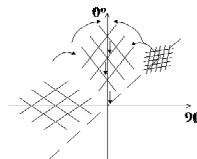
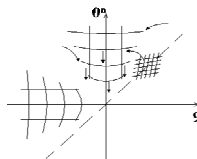
No.	Stitch pattern	No.	Stitch pattern	No.	Stitch pattern
631		633		635	
637		640		641	

Table 4: The predicted deformations in the stitched laminate structures

No.	Predicted deformation	No.	Predicted deformation	No.	Predicted deformation
631		633		635	
637		640		641	

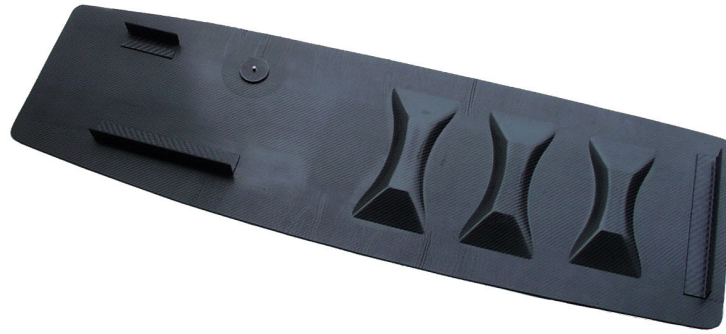


Figure 1: Creased thermoplastic composite flange for aircraft vertical tail

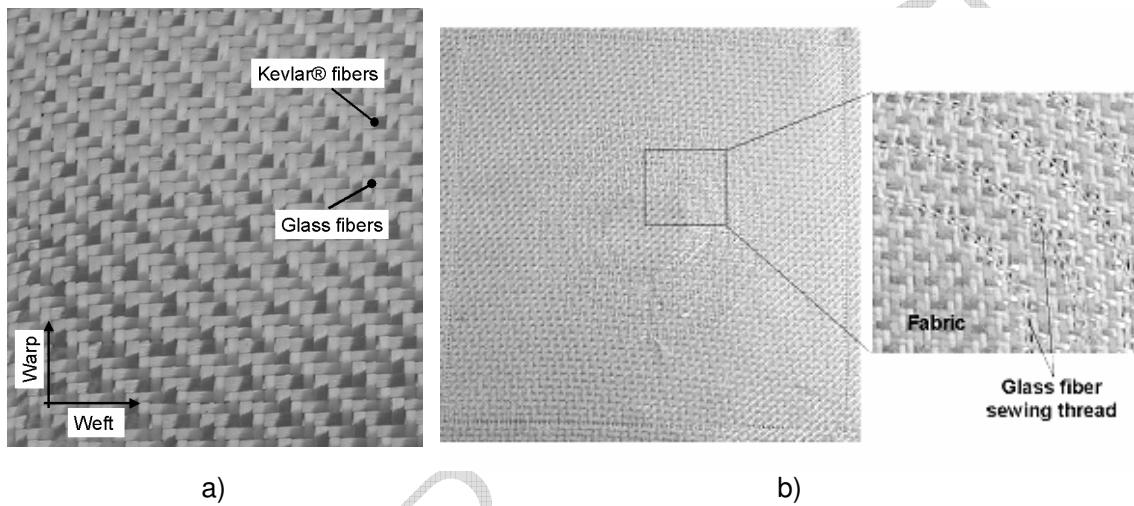


Figure 2: a) woven glass-Kevlar® fabric with 2/2 twill construction, b) example of 2 layer sewn preform

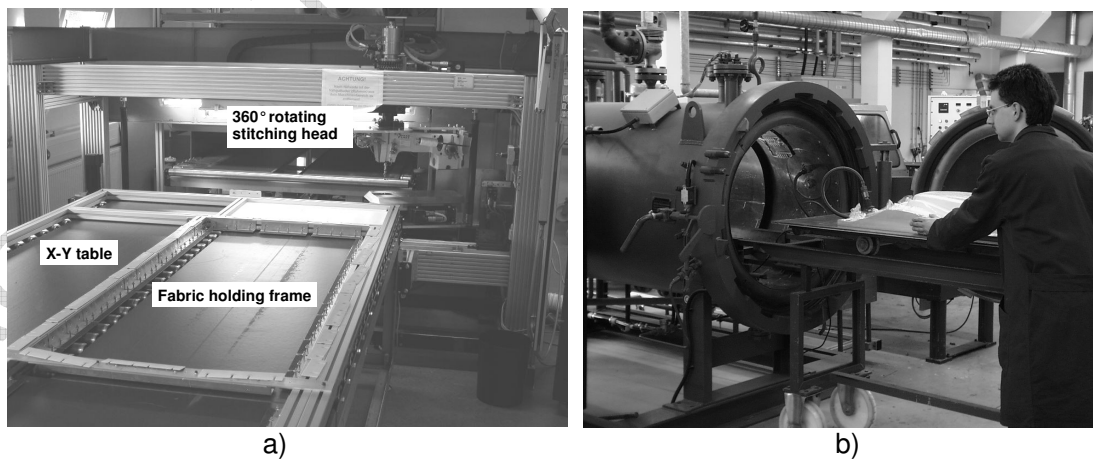


Figure 3: Equipment a) gantry stitching machine, b) autoclave for impregnation

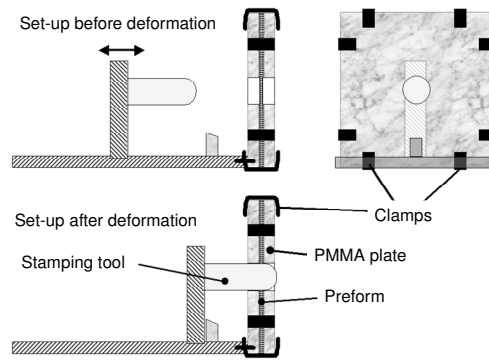


Figure 4: Schematics of lab-scale dry preform shear testing set-up

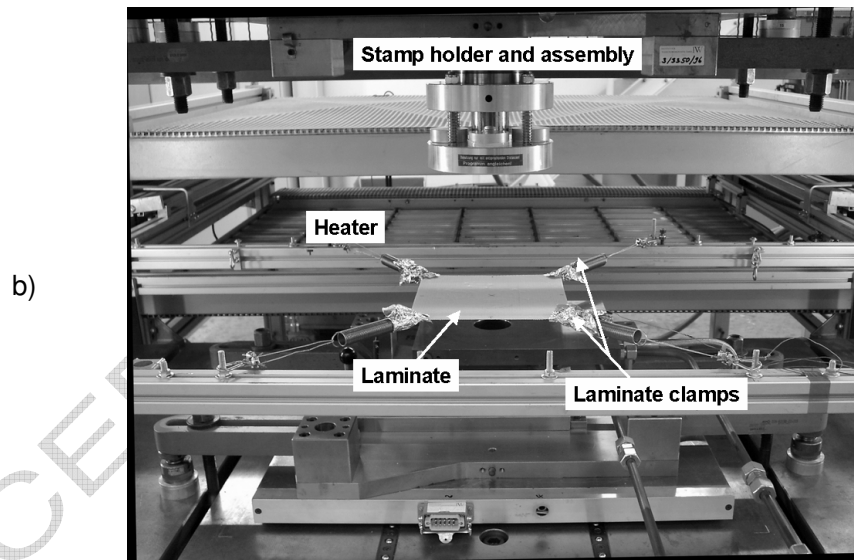
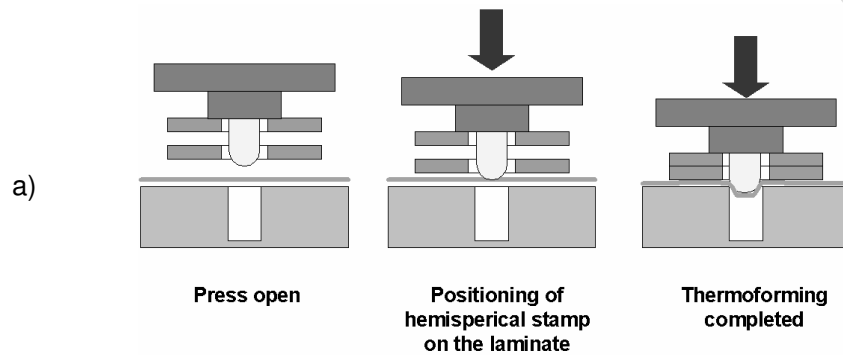


Figure 5: a) Schematics of thermoforming process, b) working set-up

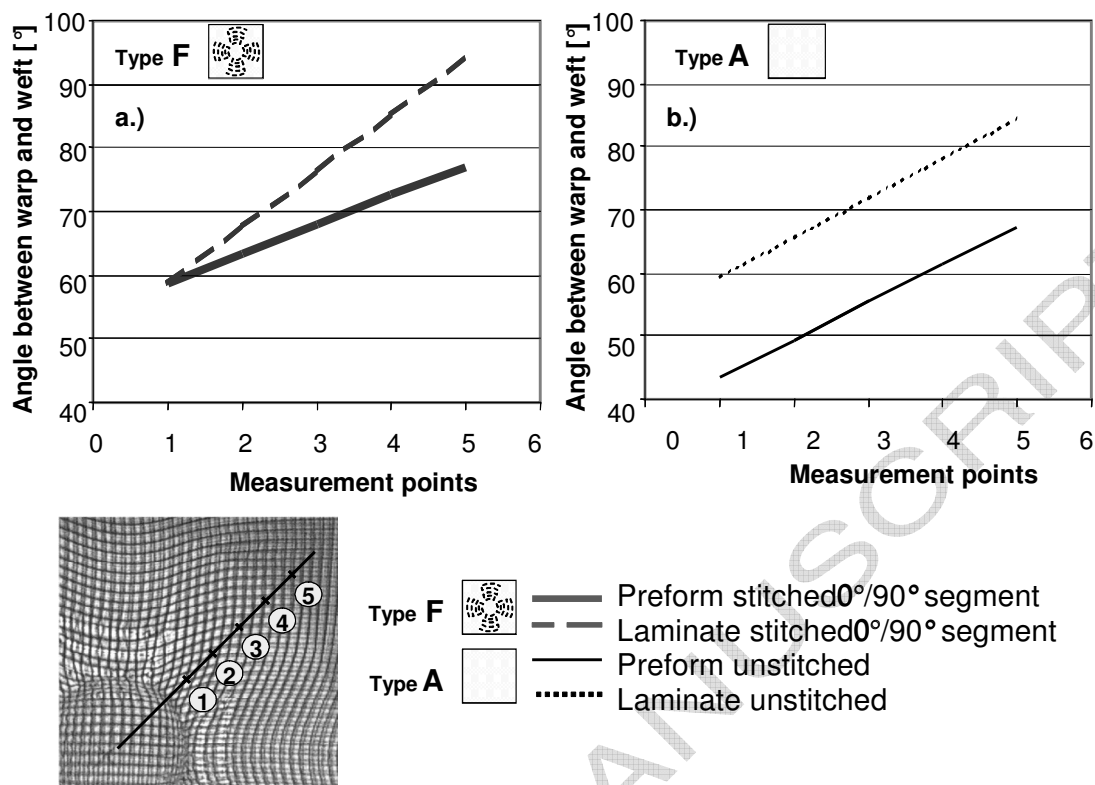


Figure 6: Shear angle between warp and weft in sheared segment stitched and unstitched preforms and laminates

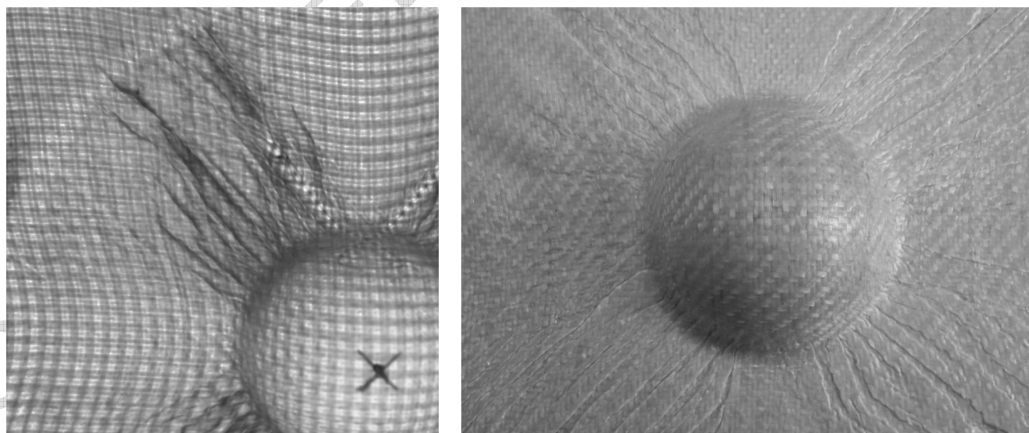


Figure 7: Wrinkling from the too high arrester function of the matrix material

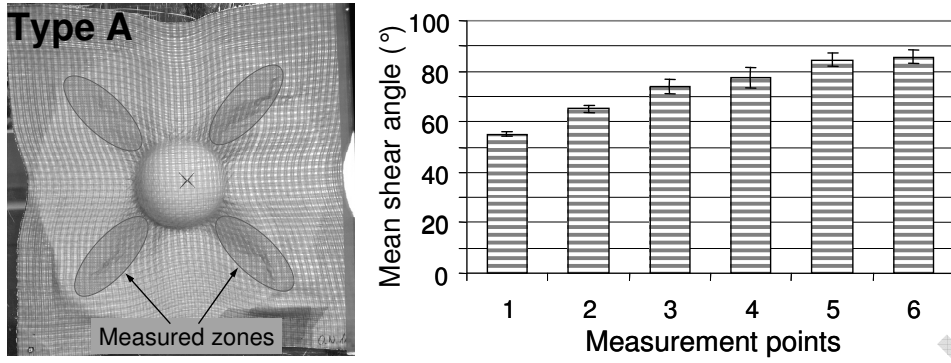


Figure 8: Mean shear angle values of the unstitched laminates

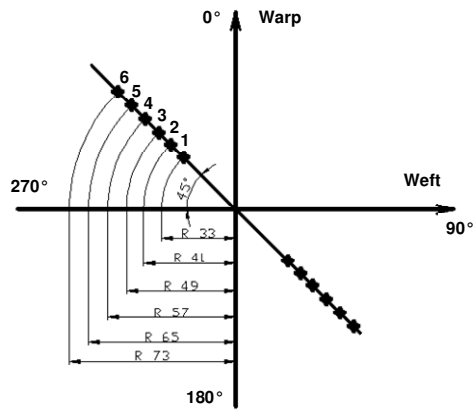


Figure 9: Measurement points along the line of maximum shearing

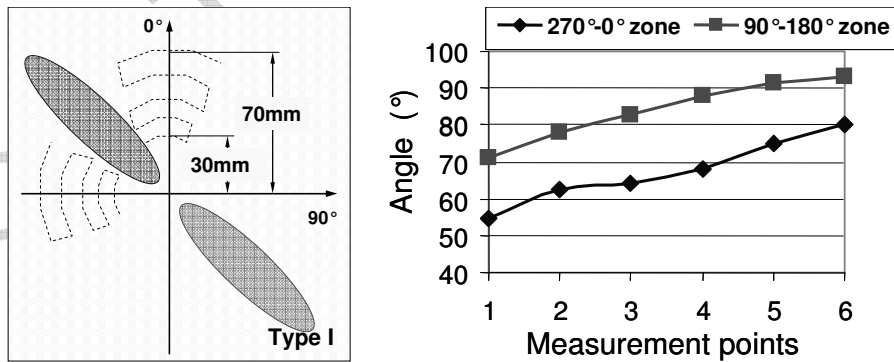


Figure 10: Shear angle values of stitched laminates Type I (270°/0° segments)

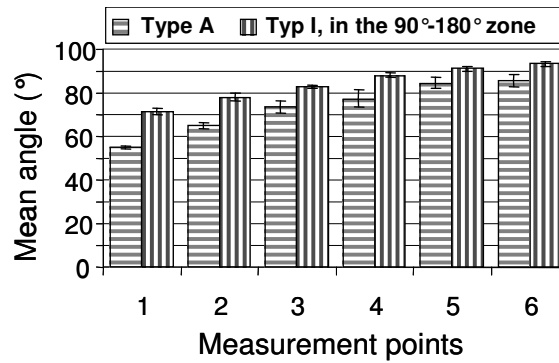


Figure 11: Shear angles on the Type I segment stitched specimen compared to the unstitched laminates

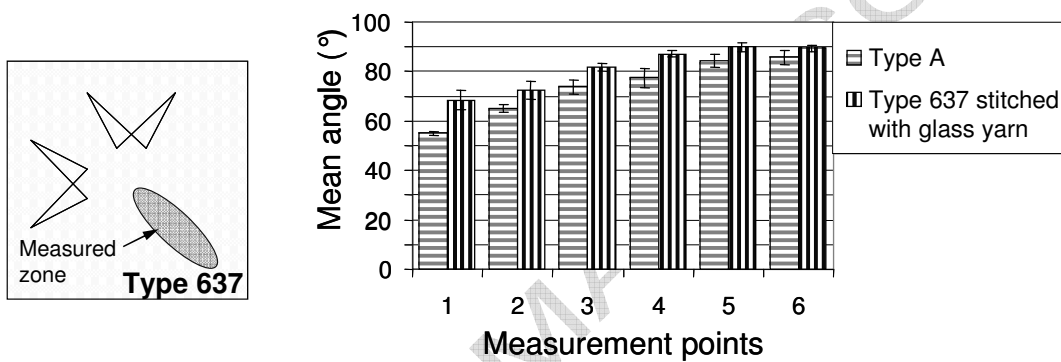


Figure 12: Results of the pattern Type 637 with glass yarns compared to the unstitched laminate

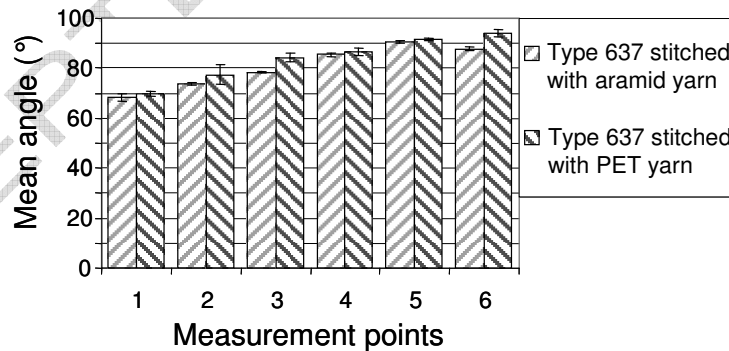


Figure 13: Mean shear angles of aramid and PET yarn stitched specimens in case of pattern Type 637