



**HAL**  
open science

## Modeling concave globoidal cam with indexing turret follower: A case study

Tuong Van Nguyen, Premysl Pokorny

► **To cite this version:**

Tuong Van Nguyen, Premysl Pokorny. Modeling concave globoidal cam with indexing turret follower: A case study. *International Journal of Computer Integrated Manufacturing*, 2009, 22 (10), pp.941-947. 10.1080/09511920902943655 . hal-00520672

**HAL Id: hal-00520672**

**<https://hal.science/hal-00520672>**

Submitted on 24 Sep 2010

**HAL** is a multi-disciplinary open access archive for the deposit and dissemination of scientific research documents, whether they are published or not. The documents may come from teaching and research institutions in France or abroad, or from public or private research centers.

L'archive ouverte pluridisciplinaire **HAL**, est destinée au dépôt et à la diffusion de documents scientifiques de niveau recherche, publiés ou non, émanant des établissements d'enseignement et de recherche français ou étrangers, des laboratoires publics ou privés.

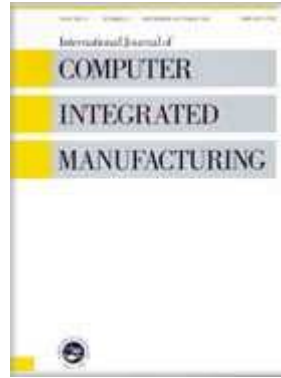

**Modeling concave globoidal cam with indexing turret follower: A case study**

Journal:	<i>International Journal of Computer Integrated Manufacturing</i>
Manuscript ID:	TCIM-2008-IJCIM-0088.R1
Manuscript Type:	Original Manuscript
Date Submitted by the Author:	20-Mar-2009
Complete List of Authors:	Nguyen, Tuong; TUL, Manufacturing systems Pokorny, Premysl; TUL, Manufacturing systems
Keywords:	CAD/CAM, CNC MACHINING, DESIGN FOR MANUFACTURE, GEOMETRIC MODELLING
Keywords (user):	Globoidal cam, pitch surface



## Modeling concave globoidal cam with indexing turret follower: A case study

TUONG NGUYEN VAN<sup>a\*</sup> and PŘEMYSL POKORNÝ<sup>b</sup>

<sup>a</sup> Department of Manufacturing Engineering, University of Nha Trang, Nha Trang, Vietnam

<sup>b</sup> Department of Manufacturing Systems, Technical University of Liberec, Liberec, Czech Republic

### Abstract

This paper describes a computer-aided design for design of the concave globoidal cam with cylindrical rollers and indexing turret follower. Three models with different modeling methods are made from the same input data. The input data include some basic dimensions of the globoidal cam system and a table of angular input and output displacements of the cam and the follower. The cam model must have no interference with the rollers when their motions are simulated in assembly conditions. In this study, Pro/ENGINEER® Wildfire 2.0 is used for modeling the cam, simulating motions and checking interference and errors of the system.

**Keywords:** Globoidal cam, sweep, pitch surface, modeling, interference.

## 1. Introduction

Globoidal cam mechanisms are widely used in industry. Compared to other cam-follower systems, the globoidal cam-follower mechanisms have many advantages, such as: compact structure, high loading capacity, low noise, low vibration, and high reliability. They are widely used in machine tools, automatic assembly lines, paper processing machines, packing machines, and many automated manufacturing devices.

In term of the shape, globoidal cam is one of the most complicated cams. Up to now, many efforts have been made in finding the way to describe the complicated surfaces of the globoidal cam. Yan and Chen ([1994, 1995, 1996](#)) derived mathematical expression for the surface geometry of globoidal cam with cylindrical, [conical](#) and hyperboloid rollers, based on coordinate transformation, differential geometry, and theory of conjugate surfaces. [These mathematical techniques were also applied by some other researchers \(Yan-ming 2000, Lee and Lee 2001, 2002, 2007, Chen and Hong 2008\)](#). To analyze the transmission error and to synthesize the tolerances, Cheng ([2002](#)) also made the geometric mathematical models of globoidal cam surface by the conjugating theory. [Some other researchers studied to create the globoidal cam from machining point of view \(Tsay and Lin 1997, Tsay and Lin 2006\)](#). [They represented the surface geometry of the globoidal cam as the swept surfaces of the tool paths. The globoidal cam profile was also constructed by using the volume swept method \(Lin et al. 2007\)](#). En-hui et al. ([2001](#)) used computer to develop a package, which is a combination of AutoCAD R14, 3D Studio Max, and VBA, to generate the surfaces of the roller gear cam. In addition, many researchers have studied [other aspects of globoidal cam such as the contact between cam surfaces and the rollers, dynamics, machining on four-axis or five-axis machine tools, etc...](#)

Deleted: on

In this paper, to illustrate the cam surfaces from angular input and output displacements of the cam and the follower, some [modelling](#) methods are presented. The term “globoidal cam surface(s)” or “cam surface(s)” refers to the working surface(s) of the globoidal cam. [The working surfaces of the globoidal cams are the surfaces that contact with the roller surfaces.](#)

## 2. Theoretical background

There are two types of globoidal cams. The first kind is the globoidal cam that has a groove on its surface and the roller follower oscillates when the cam rotates. The cam of this type is either convex or concave. The second one has one or more ribs on its surface. This type is also called roller gear drive or Ferguson drive ([Rothbart 2005](#)). This type has two subtypes: concave globoidal cam with an oscillating follower ([Figure 1\(a\)](#)) and indexing globoidal cam with a turret follower ([Figure 1\(b\)](#)). The ribs of these cams look like threads or blades so that sometimes these cams can be called thread-type or blade-type globoidal cams. Similarly to the cylindrical cam, the globoidal cam rotates at a constant angular velocity about its axis (the input axis) and the cam drives a roller follower. The axis of the follower is perpendicular to the axis of the cam and the rollers are cylindrical or conical. In this study, a double thread-type globoidal cam with cylindrical rollers for intermittent motion is the globoidal cam that [is dealt with.](#)

Deleted: we

[Figure 1](#). Globoidal cam – thread type.

As [it](#) can be seen in [Figure 1\(b\)](#), the indexing globoidal cam is similar to a worm gear. The cylindrical rollers of the follower are located radially and equally spaced on a pitch circle. When the rollers move along the guided grooves, the rollers contact with both sides of the two open ribs, while the globoidal cam with oscillating

follower has only one closed rib. Although there are some differences in shape between the two cams but their geometrical parameters can be calculated by using the similar calculations with the same formulas.

[Figure 2](#) illustrates the geometrical relationships between a concave globoidal cam and its oscillating follower. In this figure, the development plane is the plane that is normal to the axis of the roller and located anywhere along the length of the roller. The intersection point between the development plane and the axis of the roller is the pitch point (P). Datum plane is the plane normal to the cam axis and contains the follower axis. The angular displacement of the roller is measured from this plane.

[Figure 2](#). Globoidal cam- oscillating follower arrangement

Following are some parameters related to globoidal cam-follower system

([Koloc and Vaclavik 1993](#), [Reeve 1995](#)).

- $\alpha$  - angular input displacement (the rotation angle of the cam).
- $\beta$  - angular output displacement from datum plane (the rotation angle of the follower).  $\beta$  has a relationship with  $\alpha$  and it can be expressed by function  $\beta = f(\alpha)$ , ([En-hui et al. 2001](#)).
- $\beta^0$  - angle from datum plane to start of follower motion, measured in direction of motion. If the start point is encountered after the datum plane then  $\beta^0$  is positive.
- $\beta^1$  - angle between the axis of the upper roller with the datum plane. At the beginning, when the upper roller is at the starting point then  $\beta^0 = \beta^1$ .
- $\beta^2$  - angle between the axis of the lower roller with the datum plane.
- T - distance between the axis of the follower to the end of the roller, measured along the roller axis.
- E - gap between the end of the roller and the cam body.
- F - distance from the axis of the follower to the pitch point.
- C - distance between the cam axis and the turret axis.
- R - perpendicular distance from cam axis to the pitch point, expressed as
 
$$R = C - F \cdot \cos(\beta^1) \quad (1)$$
- h - distance from the pitch point to the datum plane. It is the height of the point P and presented as
 
$$h = F \cdot \sin(\beta^1) \quad (2)$$

Obviously, the coordinates of the pitch points on the rollers can be calculated if the angular input and output displacement are known. From these coordinates and

some other information, the pitch surface of the cam can be [modelled](#).

Deleted:

Deleted: modeled

### 3. **Modelling methods**

The globoidal cam can be modelled by using CAD software. In this study,

Deleted: modeled

Pro/Engineer® Wildfire 2.0 is used. There are two methods to model the globoidal

cam: pitch surface-based modelling and standard cutter-based modelling.

#### 3.1 *Pitch surface-based modelling*

Model 1:

In a globoidal cam-follower system, when the follower rotates, the locus of the roller axis will generate a ruled surface in space (Tsay and Lin 2006). When a roller engages and moves along the guided groove between the two ribs, that ruled surface becomes one of the pitch surfaces of the cam. Another roller moving in the last groove will make the other pitch surface. The globoidal cam surfaces can be obtained from the pitch surfaces by offsetting them both sides a distance that is equal to the radius of the roller, shown in Figure 3. The following is one way to model the pitch surface.

Figure 3. Offsetting the pitch surface.

Sweep a straight line that is collinear with the roller axis. The two end points of this line must lie on two three-dimensional (3D) curves (Figure 4). One of them is the origin trajectory. These 3D curves are the loci of two points, which located on the roller axis, when the follower rotating. The coordinates of those points can be calculated in the cylindrical coordinate system as

$\alpha_j$  – input angular displacement

$$h_j^i = F \cdot \sin \beta_j^i \quad (3)$$

$$R_j^i = C - F \cdot \cos \beta_j^i \quad (4)$$

where  $i = 1, 2$ , corresponding with the upper and the lower pitch surfaces;  $j =$

$1, 2, \dots, n$  corresponding with the angular output displacements.

In practice, a group of points that have the same characteristics is drawn then the curve will be modelled through these points. To reduce calculation time, and errors also, one of these curves can be a circle in the datum plane. This circle goes through the intersection point of the roller axes and its centre is in the cam axis (Figure 4).

Deleted: center

#### Figure 4. Modelling principle of model 1.

In this method, first, the body surface is modelled, and then the two pitch surfaces are done. Make two offsets from each pitch surface to get the cam surfaces. Next, some additional surfaces are added to ensure that they make closed surfaces with the body and the cam surfaces. After that, the body surface, the cam surfaces and the additional surface are merged together. All of the surfaces now become a united surface. This surface will be solidified to become a solid body. Next, perform some cuts to get the outer surfaces of the cam. Last, cut a cylindrical hole with a key groove to get the desired cam.

### **3.2 Standard cutter-based modelling**

From machining point of view, the globoidal cam surfaces can be determined by corresponding angular displacements of both the cam and the driven member (Koloc and Vaclavik 1993). If the cutter and the roller diameters are equal, the axis of the cutter now coincides with the roller axis. The motion of the cutter in the machining process represents the motion of the roller, and of course, the cutter must rotate about its axis. In this case, the input/output angular displacements of the cam and the follower can be considered processing coordinates for the cam profile fabrication.

And of course, the formulas (3) and (4) above can be used in the modelling procedure of the cam surfaces. The following are two ways to get the cam surfaces.

Model 2:



Make an intersection of a surface body and a sweep surface to form the globoidal cam surfaces if the following constrains are performed.

- (1) The sweep section is a rectangle. The width of the section is equal to the diameter of the roller. The length of the section is arbitrary providing that it is longer than the length of the roller plus the clearance  $e$  (Figure 2).
- (2) Sweep this section and the axis of the section must follow two 3D curves. These curves are loci of two points, which are on the roller axis, when the follower rotates. One of these curves is the origin trajectory. The curves that are used for model 1 can be applied here.
- (3) This section plane is always normal to the origin trajectory.

In this method, first, a body surface is modelled, and then two sweep surfaces are created. Next, two additional surfaces are added to both ends of each sweep surface to ensure that they make closed surfaces with the body and the cam surfaces. After that, all surfaces are merged together. Then the united surface will be converted to solid body. Next, perform some cuts to get the outer surfaces of the cam. Last, a cylindrical hole with a key groove is cut to get the desired cam.

Model 3:

Cut the solid bank by a rectangular section to form the globoidal cam surfaces, using the same constrains of model 2 for this model. In this method, first a solid body is modelled. Then, two cuts are performed to get the cam surfaces. Next, perform some cuts to get the outer surfaces of the cam. Last, cut a cylindrical hole with a key groove to get the desired cam.

#### 4. Application example

##### 4.1 Input data and pre-calculations

A globoidal cam indexing mechanism has 6 rollers, which are equally spaced on a pitch circle. Following are some parameters of the system, which are showed in

Figure 2:  $d = 25.4$  mm,  $l = 17$  mm,  $C = 118$  mm,  $t = 59.5$ mm,  $e = 1.5$  mm. A part of angular input and output displacements of the cam and the follower is presented in

Table 1 in the appendix.

There are some calculations that must be done before making the models as follows:

(a) Convert the values of angular input and output displacements from incremental coordinates to absolute coordinates.

(b) Calculating the angle  $\beta_j^1$  for each groove, with:

$$\beta_j^1 = \beta_j + \beta^0 \quad (5)$$

where  $\beta_j$  is the angular output displacement.

(c) Calculating the coordinates of the pitch points for each pitch surface. The pitch points are located at the distance  $F=61\text{mm}$  on the roller axes.

All the calculations are done in Microsoft Excel 2003.

#### 4.2 The *modelling results and checking interference*

In [Figure 5](#) are three models of the cam designed from preceding data. In this figure, the pitch surfaces are in transparent state to see the cam surfaces easily. All cams look great and similar in shape. To choose the best model, the interference between the cam and the rollers must be verified. The best cam is the one that has no interference between components in the system and there is no clearance between the cam surfaces and the roller or the clearance must be small enough.

[Figure 5](#). Three models of globoidal cam.

In order to verify the interference, first, an assembly of the cam and the follower is made. After that, use the Mechanism Design module to define the geometrical relationships of the system, make it move and analyze its motion also.

Last, use a [kinematics](#) analysis to obtain information on interference between components

When the globoidal cam rotates the follower will stay or rotate depending on the location of the rollers on the cam surfaces. The follower will not move when the

Deleted: kinematic

rollers still contact with the cam surfaces in the dwell period. To get a motion for the follower, a point on one roller axis has to trace along a 3D curve on the pitch surface. The pitch point now can be used for this purpose. The 3D curve can be one of the two 3D curves that used to model the cam.

Among the three models, model 1 has no interference between the cam and the roller when the cam rotates. Model 2 and 3 have 296 and 280 positions of interference, respectively. There are totally 721 positions checked for a full revolution of the cam. The angle between two positions (called frames in Mechanism Design) is  $0.5^{\circ}$ . This value is similar to the incremental value of the angular input displacement of the cam. In the last two models, the interferences occur in the index period. It is because, in this period, the width of the grooves is smaller than the diameter of the rollers, although using a cutting section that has the same size that of the cutter generates the grooves. This error may come from the sweep algorithm in Pro/Engineer where the origin trajectories have strong curvatures. The result is that model 1 is the best cam.

The side clearances in assembly between cam surfaces of model 1 and the rollers must be checked to ensure that they are small enough. If these clearances are large, the errors of output angular displacements will be large, too. These clearances can be measured in assembly standard mode or in mechanism mode. Some examples of errors are presented in Table 2 in the appendix. In general, in one revolution of the cam, the clearances are always less than 0.2 micrometer. These clearances could cause errors in the output angular displacements but these errors are so small that they can be accepted.

**Deleted:** may

**Deleted:** very

**Deleted:** and

**Figure 6.** Interferences (in red colour) occur between components.

## 5. Conclusion

A system is developed to create 3D model of an indexing globoidal cam from the input and output displacements of the cam and the follower and some basic dimensions of the system. In this approach, by using the software Pro/Engineer® Wildfire 2.0, some models of the globoidal cam are modelled from the same input data. The result is that the model 1, which its pitch surfaces are obtained by sweeping straight lines along two curves, is the best case. With this model, no interference between components is found when the cam mechanism works. The errors of angular rotation of the follower can be accepted because the clearances between cam surfaces and the rollers are so small that they have no real affect on the follower performance. This is a real example but the modelling procedures can be applied for other situations when the angular input and output displacements are known. The result of this study is very useful in terms of modelling and manufacturing globoidal cam.

Deleted: very

## Acknowledgements

The work upon which this paper is based is a part of MSM-4674788501 research program, grant from the Technical University of Liberec, Czech Republic.

## References

- Chen, S.L. and Hong, S.F., 2008. Surface generation and fabrication of roller gear cam with spherical roller. *Journal of Advanced Mechanical Design, System, and Manufacturing*, 2 (3), 290-302.
- Cheng, H.Y., 2002. Optimum tolerances synthesis for globoidal cam mechanism. *JSME international Journal, series C*, 45 (2), 519-526.
- En-hui, Y., Chun, Z. and Ji-xian, D., 2001. Creating surface of globoidal indexing cam profile on computer. *Journal of Northwest University of Light Industry*, 19 (1), 41-43.
- Koloc, Z. and Vaclavik, M., 1993. *Cam mechanism*. Prague: Publisher of Technical Literature of Prague.
- Lee, R.S. and Lee, J.N., 2001. A New Tool-Path Generation Method Using a Cylindrical End Mill for 5-Axis Machining of a Spatial Cam with a Conical Meshing Element. *The International Journal of Advanced Manufacturing Technology*, 18 (9), 615-623.
- Lee, R.S. and Lee, J. N., 2002. New method of tool orientation determination by enveloping element for five-axis machining of spatial cam. *International Journal of Production Research*, 40 (10), 2379-2398

- Lee, R.S. and Lee, J.N., 2007. Interference-free toolpath generation using enveloping element for five-axis machining of spatial cam. *Journal of Materials Processing Technology*, 187-188, 10-13.
- Lin, B.J., Lin, C.C., Jywe, W.Y., Lin, S.Y. and Lin, J.C., 2007. Motion-curve synthesis and geometric design of globoidal cam mechanism with intermittent variable speed. *Proceedings of the Institution of Mechanical Engineers, Part C: Journal of Mechanical Engineering Science*, 221 (3), 329-339.
- Reeve, J., 1995. *Cam for industry*, London: Mechanical Engineering Publications.
- Rothbart, H.A. (editor), 2004. *Cam design handbook*, New York: McGraw-Hill.
- Tsay, D.M. and Lin, B.J., 1997. Design and Machining of Globoidal Index Cams. *Journal of Manufacturing Science and Engineering*, 119 (1), 21-29.
- Tsay, D.M. and Lin, S.Y., 2006. Generation of globoidal cam surfaces with conical roller-followers. *ASME 2006 International Design Engineering Technical Conferences & Computers and Information in Engineering Conference*, DETC2006-99683, New York: ASME.
- Yan, H.S. and Chen, H.H., 1994. Geometry design and machining of roller gear cams with cylindrical rollers. *Mechanism and Machine Theory*, 29 (6), 803-812.
- Yan, H.S. and Chen, H.H., 1995. Geometry design of roller gear cams with hyperboloid rollers. *Mathematical and computing modelling*, 22 (8), 107-117.
- Yan, H.S. and Chen, H.H., 1996. Geometry Design of Globoidal Cams With Generalized Meshing Turret-Rollers. *Journal of Mechanical Design*, 118 (2), 243-249.
- Yan-ming, F.U., 2000. Analysis and design of the globoidal indexing cam mechanism. *Journal of Sganhai University (English edition)*, 4 (1), 54-59.

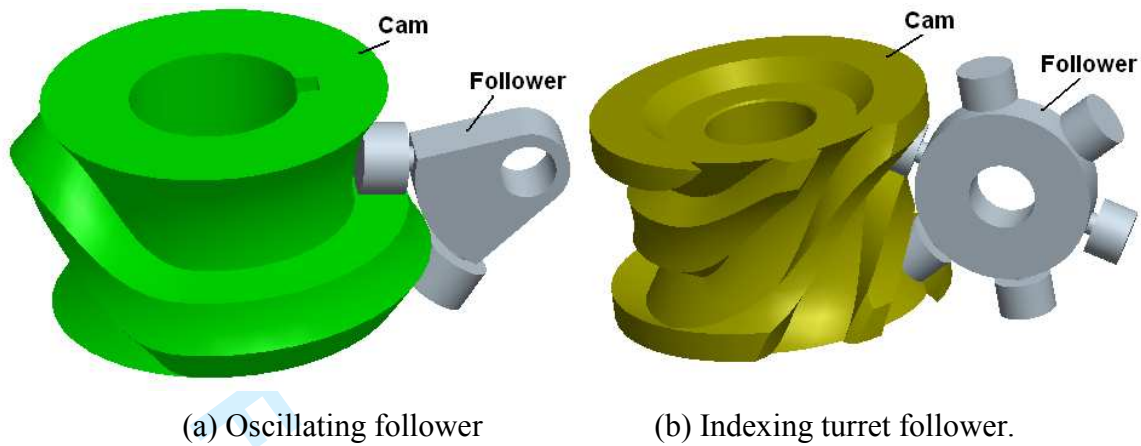

Figure 1. Globoidal cam - thread type.

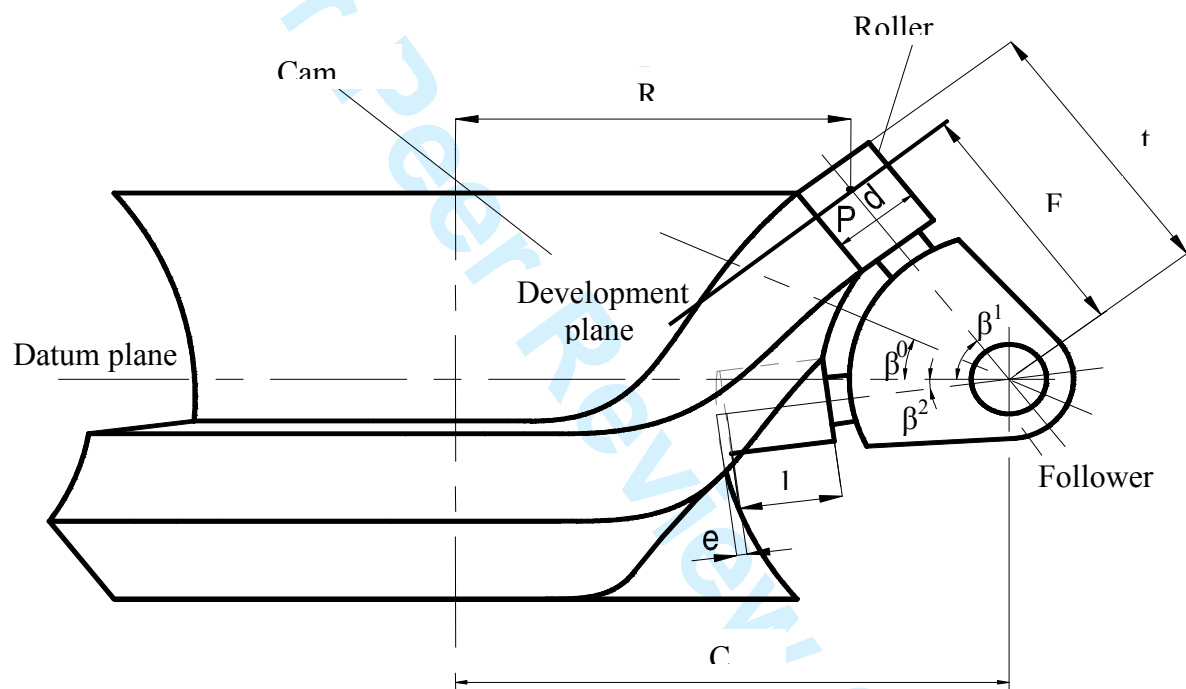

Figure 2. Globoidal cam- oscillating follower arrangement

Following are some parameters related to globoidal cam-follower system (Koloc and Vaclavik 1993 and Reeve 1995).

$\alpha$  - angular input displacement (the rotation angle of the cam).

$\beta$  - angular output displacement from datum plane (the rotation angle of the follower).  $\beta$  has a relationship with  $\alpha$  and it can be expressed by function  $\beta = f(\alpha)$ , (En-hui *et al.* 2001).

$\beta^0$  - angle from datum plane to start of follower motion, measured in direction of motion. If the start point is encountered after the datum plane then  $\beta^0$  is positive.

$\beta^1$  - angle between the axis of the upper roller with the datum plane. At the beginning, when the upper roller is at the starting point then  $\beta^0 = \beta^1$ .

$\beta^2$  - angle between the axis of the lower roller with the datum plane.

$t$  - distance between the axis of the follower to the end of the roller, measured along the roller axis.

$e$  – gap between the end of the roller and the cam body.

$F$  - distance from the axis of the follower to the pitch point.

$C$  - distance between the cam axis and the turret axis.

$R$  - perpendicular distance from cam axis to the pitch point, expressed as

$$R = C - F \cdot \cos(\beta^1) \quad (1)$$

$h$  – distance from the pitch point to the datum plane. It is the height of the point P and presented as

$$h = F \cdot \sin(\beta^1) \quad (2)$$

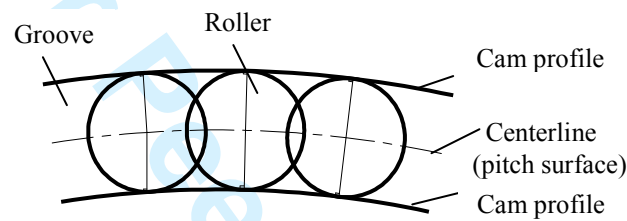

Figure 3. Offsetting the pitch surface.

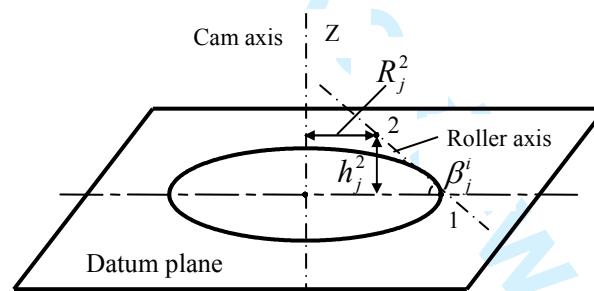
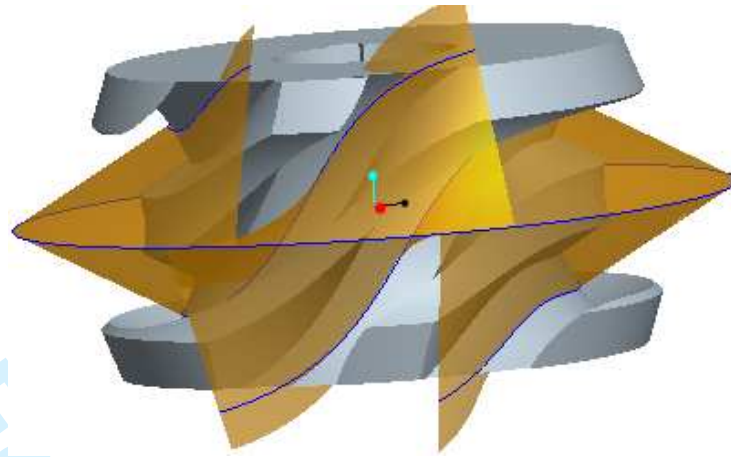
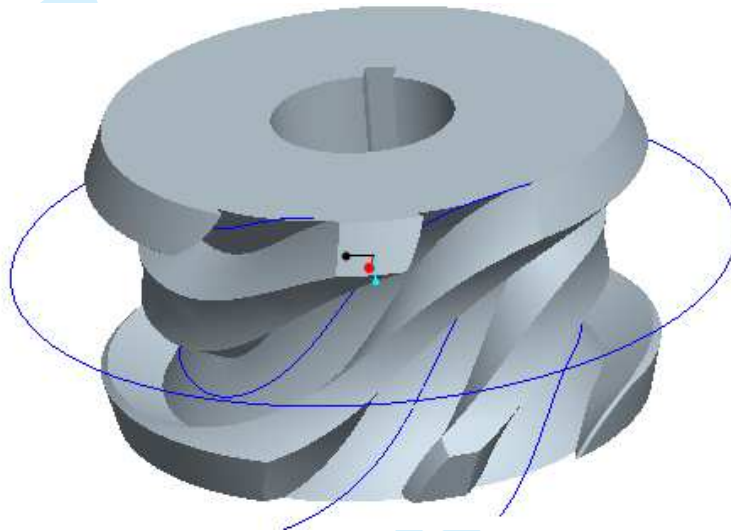

Figure 4. Circle in the datum plane.



(a) Pitch surfaces and cam – model 1



(b) Cam – model 2

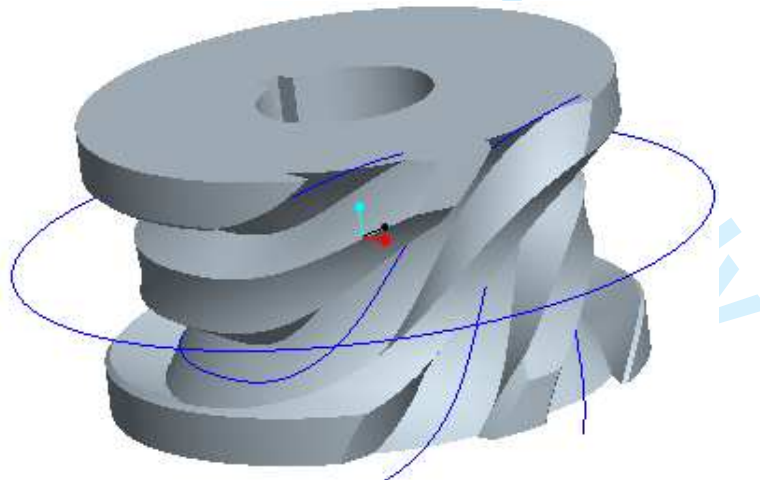

(c) Cam – model 3

Figure 5. Three models of globoidal cam.



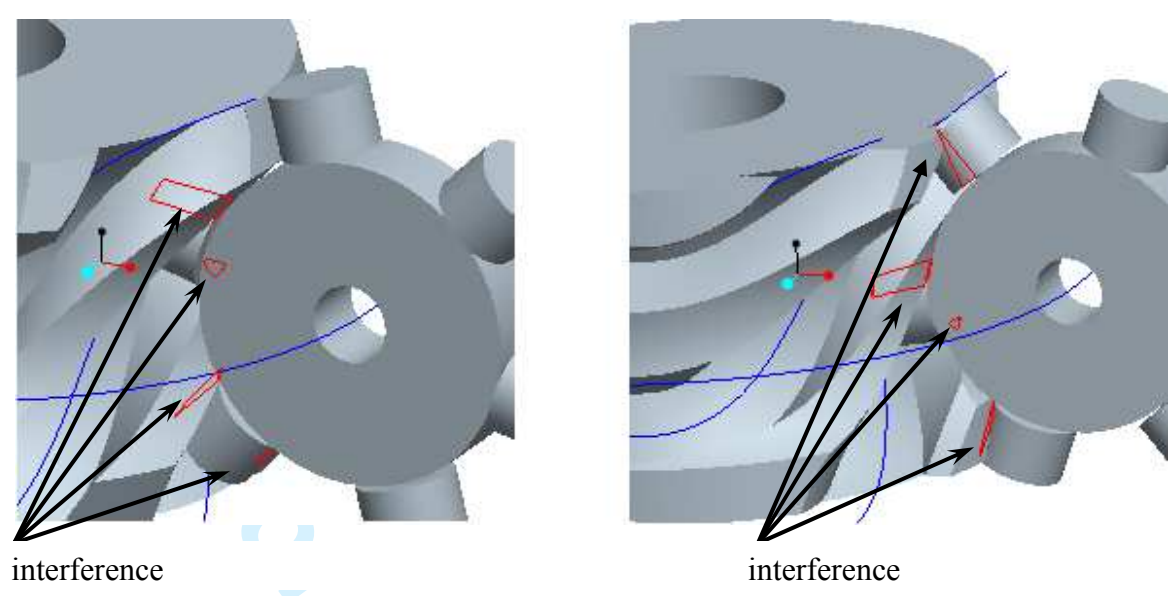

Figure 6. Interferences (in red colour) occur between components

## Appendix

Table 1: Angular input and output displacements, unit: Degree

No	$\alpha$	$\beta$	No	$\alpha$	$\beta$
1	0	0	1	0	0
2	0.5	0.6471	2	0.5	0.5427
3	0.5	0.6438	3	0.5	0.5479
5	0.5	0.6403	5	0.5	0.5531
6	0.5	0.6368	6	0.5	0.5582
7	0.5	0.6331	7	0.5	0.5633
8	0.5	0.6294	8	0.5	0.5683
9	0.5	0.6256	9	0.5	0.5731
10	0.5	0.6216	10	0.5	0.578
...	...	...	...	...	...
118	0.5	0.0001	209	0.5	0.0001
119	0.5	0	210	0.5	0
...	...	...	...	...	...
539	0.5	0	630	0.5	0
540	0.5	0.0004	631	0.5	0.0004
...	...	...	...	...	...
739	0.5	0.578	739	0.5	0.6217
740	0.5	0.5731	740	0.5	0.6256
741	0.5	0.5682	741	0.5	0.6294
742	0.5	0.5633	742	0.5	0.6331
743	0.5	0.5582	743	0.5	0.6368
744	0.5	0.5531	744	0.5	0.6403
745	0.5	0.5479	745	0.5	0.6437
746	0.5	0.5427	746	0.5	0.6471
Roller in groove 1 Starting point: $\alpha=196.50$ , $\beta=-67.3831$ End point: $\alpha=209.00$ , $\beta=67.5842$			Roller in groove 2 Starting point: $\alpha=151.00$ , $\beta=-67.5842$ End point: $\alpha=163.50$ , $\beta=67.3831$		

Table 2: Example of some selected clearances between cam surfaces and rollers

$\alpha$ [deg]	$e_1$ [ $\mu\text{m}$ ]	$e_2$ [ $\mu\text{m}$ ]	$e_3$ [ $\mu\text{m}$ ]	$e_4$ [ $\mu\text{m}$ ]
0	-	0.0585316	0	0
15	0.0528666	-	0.0351234	0.0473915
30	0.063994	0.0502574	0.0056034	0.0362505
45	0.0243202	0.0170940	0.0581564	0.0820387
60	0	0.0703851	0.0011278	0.0010219
75	0	0.0605575	0.0003903	0.0011722
90	0	0.0706481	0.0032800	0.0017334
105	0.0055780	0.0142335	0	0.0957572
120	0.0063138	0.0132114	0	0.0950316
135	0	0.0706482	0.0024268	0.0017334
150	0.0060959	0.0060959	0	0.0952285
165	0.0061338	0.0134631	0	0.0952182
180	0	0.0706481	0.0024268	0.0017334
195	0.0064939	0.0130263	0	0.0953030
210	0.0033976	0.0167813	0	0.0945793
225	0	0.0706372	0.0024266	0.0017335
240	0	0.0845015	0.0090981	0.125517
255	0	0.0587580	0.0120980	0.0184087
270	0	0.0857001	0.0019144	0.0147282
285	0.0161315	0.0409393	0.0386007	0
300	0.0000570	0.0421791	0.0071429	0
315	0	0	0.124019	0
330	0	0.0887387	0	-
345	0.0065067	0.202810	0.0229045	0
360	-	0.0585316	0	0

Note:  $e_1, e_2$ : clearance between surfaces 1, 2 and roller in groove 1 (model 1).

$e_3, e_4$ : clearance between surfaces 2, 4 and roller in groove 2 (model 1).