



HAL
open science

Congenital dyserythropoietic anemia type II (CDAII / HEMPAS): Where are we now?

Jonas Denecke, Thorsten Marquardt

► To cite this version:

Jonas Denecke, Thorsten Marquardt. Congenital dyserythropoietic anemia type II (CDAII / HEMPAS): Where are we now?. *Biochimica et Biophysica Acta - Molecular Basis of Disease*, 2009, 1792 (9), pp.915. 10.1016/j.bbadis.2008.12.005 . hal-00517927

HAL Id: hal-00517927

<https://hal.science/hal-00517927>

Submitted on 16 Sep 2010

HAL is a multi-disciplinary open access archive for the deposit and dissemination of scientific research documents, whether they are published or not. The documents may come from teaching and research institutions in France or abroad, or from public or private research centers.

L'archive ouverte pluridisciplinaire **HAL**, est destinée au dépôt et à la diffusion de documents scientifiques de niveau recherche, publiés ou non, émanant des établissements d'enseignement et de recherche français ou étrangers, des laboratoires publics ou privés.

Accepted Manuscript

Congenital dyserythropoietic anemia type II (CDAII / HEMPAS): Where are we now?

Jonas Denecke, Thorsten Marquardt

PII: S0925-4439(08)00267-6
DOI: doi:[10.1016/j.bbadis.2008.12.005](https://doi.org/10.1016/j.bbadis.2008.12.005)
Reference: BBADIS 62905

To appear in: *BBA - Molecular Basis of Disease*

Received date: 6 October 2008
Revised date: 6 December 2008
Accepted date: 15 December 2008



Please cite this article as: Jonas Denecke, Thorsten Marquardt, Congenital dyserythropoietic anemia type II (CDAII / HEMPAS): Where are we now?, *BBA - Molecular Basis of Disease* (2008), doi:[10.1016/j.bbadis.2008.12.005](https://doi.org/10.1016/j.bbadis.2008.12.005)

This is a PDF file of an unedited manuscript that has been accepted for publication. As a service to our customers we are providing this early version of the manuscript. The manuscript will undergo copyediting, typesetting, and review of the resulting proof before it is published in its final form. Please note that during the production process errors may be discovered which could affect the content, and all legal disclaimers that apply to the journal pertain.

**Congenital dyserythropoietic anemia type II (CDAII / HEMPAS): where
are we now?**

Jonas Denecke^{1*}, Thorsten Marquardt²

¹University Hospital of Rostock, Department of Pediatrics, Germany

²University Hospital of Muenster, Department of Pediatrics, Germany

* Corresponding author:

Jonas Denecke, M.D.

Department of Pediatrics

Rembrandtstraße 16/17

18057 Rostock

Germany

Phone: 00 49 381 4947060

Fax : 00 49 381 4947051

E-mail: deneckj@uni-muenster.de

Abstract:

Congenital diserythropoietic anemias (CDA) were classified according to bone marrow changes and biochemical features 40 years ago. A consistent finding in CDA type II, the most frequent subgroup of CDAs is a relevant hypoglycosylation of erythrocyte membrane proteins. It is a matter of debate if the hypoglycosylation is the primary cause of the disorder or a phenomenon secondary to other pathomechanisms.

The molecular cause of the disorder is still unknown although some enzyme deficiencies have been proposed to cause CDA II in the last two decades and a linkage analysis locating the CDA II gene in a 5 cM region on chromosome 20 was done in 1997.

In this review biochemical and genetic data are discussed and diagnostic methods based on biochemical observations of the recent years are reviewed.

Keywords: Hemphas; CDA II; congenital disorders of glycosylation; dyserythropoiesis; erythrocyte membrane glycosylation; CDAN2

The family of congenital dyserythropoietic anemias

Congenital dyserythropoietic anemia type II (CDA II) also known as hereditary erythroblastic multinuclearity with positive acidified-serum test (HEMPAS) is the most frequent member of the family of congenital dyserythropoietic anemias consisting of three entities:

CDA I is characterized by megaloblastic changes, ineffective erythropoiesis and nuclear abnormalities of erythroblasts including a “swiss chese”-aspect of erythroblasts on electron microscopy. Hemoglobin levels are variable with mean hemoglobin levels between 8-11 mg/dl [1]. The disorder follows an autosomal recessive trait. After linkage analysis [2] the gene defect in CDA I could be characterized as codanin-1 (CDAN1) [3]; the function of the gene product is unknown. In about 10% of CDA I patients skeletal abnormalities are associated with the disorder [4]. Several patients show a response to alpha-interferon therapy with increased blood hemoglobin levels and decreased iron overload. More than 150 patients suffering from CDA I are known.

CDA III is a more heterogeneous disorder consisting of subtypes with an autosomal recessive trait or sporadic occurrence. Most data are derived from a large family living in Sweden. Patients show dyserythropoiesis with giant multinucleated erythroblasts. In most cases anemia is mild and does not require transfusions. In contrast to other types of CDA no relevant iron overload can be noticed.

Only a few patients with CDA III have been described. The genetic defect is unknown although mapping analysis located the CDA III-gene to a 4.5-cM interval at chromosome 15p23 [5].

CDA II is the most frequent member of the congenital dyserythropoietic anemia family. More than 300 patients are known [6]. CDA II patients show characteristic biochemical and bone marrow changes that can be used for diagnostic purposes. A common finding in all typical

CDA II patients is an impaired glycosylation of erythrocyte membrane proteins [7]. The molecular basis is still unknown.

Clinical picture of CDA II

Mild to severe anemia, jaundice and splenomegaly are the predominant symptoms. Red cell size is mostly normocytic; the mean hemoglobin concentration is 9.1-9.8 g/dl [6]. Most CDA II patients do not require regular transfusions. However, up to 15% of the patients show transfusion dependent anemia and some patients were treated by bone marrow transplantation [8]. The mean age at diagnosis in a large collection of patients was 18.2 years [6]. Splenomegaly is present in 50-60% of CDA II patients. Beyond the age of 20 most patients develop iron overload and some patients develop liver cirrhosis, diabetes and heart failure [6, 9].

Bone marrow in CDA II

The classification of congenital dyserythropoietic anemias was done on the basis of characteristic changes of bone marrow cytology [10]. Bone marrow samples show distinct hypercellularity due to erythroid hyperplasia with 45-90% erythroid precursors. In CDA II, 10 to 45 percent (mean 20%) of all erythroblasts are bi- and multinucleated [10, 11] (Fig.1). If characteristic erythroblasts are present the diagnosis of CDA II is very likely although cases with typical bone marrow morphology but without typical biochemical alterations are known.

Biochemical changes in CDA II

Glycosylation in CDA II

CDA II Band 3 (anion exchange protein 1) and band 4.5 (glucose transporter 1), two abundant erythrocyte membrane proteins, show a sharper band and faster migration on sodium dodecyl

sulfate-polyacrylamide gel electrophoresis (SDS-PAGE) due to decreased glycosylation [12, 13]. The main erythrocyte membrane protein represents band 3 comprising 25-30% of total erythrocyte membrane protein [14]. Band 3 normally carries two polylactosamine chains ($[-3\text{Gal}\beta 1,4\text{-GlcNAc}\beta 1-]_n$) attached to a single N-linked bi-antennary asparagine-linked trimannosyl core structure [15] (Fig.2). In CDA II, band 3 and other red blood cell membrane proteins carry altered N-glycans with truncated polylactosamine structures [15, 16]. Immature glycans like hybrid- and high mannose oligosaccharides are more abundant in CDA II membrane proteins [15, 16] but there is no predominant N-glycan indicating a specific enzyme deficiency in the synthesis of the glycan. MALDI-TOF analysis of N-glycans derived from normal band 3 revealed a broad spectrum of small, medium and large polylactosamine type structures [17]. In contrast to normal band 3, the largest N-glycans released from CDA II band 3 were truncated and predominantly contained only one or two lactosamine repeats. In summary, the typical alteration of N-glycans derived from CDA II erythrocytes is a truncation of the glycans and the increase of immature high mannose and hybrid glycans. Further analysis using antibodies to linear polylactosamines (i-antibodies) and ESI-MS analysis clearly demonstrated, that polylactosamines on band 3 are not only truncated but also altered since branching of polylactosamines causing the I-phenotype of erythrocytes is missing in CDA II erythrocytes [18, 19]. Whether the lack of polylactosamine branching is a primary phenomenon of CDA II erythroblasts or due to the general shortening of N-glycans remains unclear.

Zdebska et al determined the molar composition of erythrocyte glycoconjugates in various CDA II patients and heterozygous gene carriers. Total carbohydrates on CDA II band 3 were reduced to about half of the carbohydrate content of healthy controls [20, 21]. Obligatory heterozygous gene carriers showed an intermediate content of N-glycans [21]. Polyglycosylceramides in normal red cells carry polylactosaminoglycans similar to those on

band 3 attached to ceramide instead of N-glycans. The amount of glycosphingolipids, lactotriaosylceramides, neolactotriaosylceramide and polyglycosylceramides is increased in CDA II erythrocytes [22]. This could be caused by the prolongation of G1 and possibly M phases of the mitotic cycle of the erythroid cells in which glycolipids are preferentially synthesized [23]. There are inconsistent data about the glycosylation of ceramides on erythrocytes. Zdebska et al demonstrated that ceramides are hypoglycosylated in CDA II red cells whereas the total amount of polyglycosylceramides is increased [22]. However, Fukuda et al described that poly-lactosaminylceramides are increased in CDA II red cells [24]. PNGaseF digestion of CDA II erythrocyte membrane proteins, exclusively cleaving N-linked oligosaccharides, resulted in a band 3 with an apparent molecular weight identical to healthy controls indicating a defect predominantly affecting the N-glycosylation in erythroblasts [17].

There is one report that not only erythrocyte membrane proteins but also serum transferrin, that is synthesized in the liver is hypoglycosylated in CDA II [25]. Due to the presence of high mannose and hybrid glycans on transferrin the authors suggested a common cause for hypoglycosylation of transferrin and erythrocytes in CDA II. We performed analysis of transferrin in 10 CDA II patients using isoelectric focusing and could not detect hypoglycosylation (data not shown).

Due to the frequency of iron overload in CDA II patients, mild hypoglycosylation of transferrin in the cohort investigated by Fukuda et al may be secondary to impaired liver function and not a feature of the disorder.

Investigation of glycophorin A, an erythrocyte membrane protein that carries 12 O-glycans and one N-glycan, demonstrated a hypoglycosylation of the protein in CDA II with respect to N- and O-glycosylation.

In summary, investigation of glycosylation in CDA II erythrocytes indicates that the defect impairs mainly N-glycosylation but may also affect glycosylation of ceramides and O-glycosylation of proteins [26].

“Double membranes” in CDA II erythrocytes

The phenomenon of double membranes in late erythroblasts and some erythrocytes from CDA II patients was first described in 1972 [27]. The origin of the membrane structure close to the erythrocyte membrane was suggested to be endoplasmic reticulum [28-30]. In 1996, Alloisio et al. proved the inner membrane fragments to be endoplasmic reticulum using western blot and electron microscopic studies [31].

The elimination of organelles is a unique feature of erythroid cell maturation. Late in erythropoiesis the erythroblast loses its nucleus and becomes a reticulocyte which further degrades internal organelles in order to become a mature erythrocyte [32]. In addition to the nuclear abnormalities unique to CDA II erythroblasts, the retention of organelle residues suggests that CDA II might be a maturation disorder of erythroblasts indicating that the hypoglycosylation of membrane proteins could be a secondary phenomenon.

Enzyme activity studies in CDA II

The consistent truncation of N-glycans on band 3 of erythrocyte membranes in CDA II led to the assumption that CDA II is primarily a disorder of glycosylation.

In the past, three different biochemical defects in the N-glycosylation pathway were proposed to cause CDA II on the basis of enzyme activity data, western or southern blots, or expression studies: i) a defect of α -mannosidase II [33] ii) a defect of N-acetylglucosaminyltransferase II [24] and iii) a defect of a membrane-bound galactosyltransferase [34].

In one patient, enzyme activities of GlcNAcT I, GlcNAcT II, GalT, GlcNAcT VIII and α -mannosidase II were determined in peripheral mononucleated cells and cultured B lymphocytes. [33]. While the enzyme activities of GlcNAcT I, GlcNAcT II, GalT and GlcNAcT VIII were comparable to healthy controls, the activity of α -mannosidase II was reduced and expression of α Man II assayed by northern blot analysis was reduced to <10% of controls. The hypothesis that α Man II plays a role in the pathogenesis of CDA II was supported by mice defective in α -mannosidase II that develop dyserythropoiesis and anemia. In these mice, an alternate pathway using α -mannosidase III compensates for the defect in non-erythroid mouse cell types [35].

In 2 patients with clinical and biochemical signs of CDA II, the activity of GlcNAcT II was assayed using lymphocytes. The activity of GlcNAcT II was reduced to 10% in one patient and to 30% of the activity of healthy controls in the second CDA II patient [24].

In another patient characterized by a lack of polylactosamines on erythrocyte proteins and membrane bound ceramides, Fukuda et al found the activity of a membrane-bound galactosyltransferase reduced to 24 % in mononucleated cells compared to controls. The overall galactosyltransferase activity in the serum of the patient was increased and the authors proposed a defect of a membrane-bound form of a galactosyltransferase as the cause of CDA II in this patient [34].

Although the enzymatic data were promising to explain the hypoglycosylation in CDA II molecular analysis of the respective genes revealed no mutations, neither in the case with low α -mannosidase II activity and decreased α -mannosidase II mRNA [33], nor in the case with aberrant splicing of the α -mannosidase II gene [36], nor in the case with low activity of the membrane bound galactosyltransferase (M. Fukuda, personal communication).

The major pitfall of all these enzyme activity studies is that – due to limited availability of erythroblasts - they were performed on cells not primarily affected by CDA II. In addition, the

studied enzymes are of general importance for the N-glycan synthesis in several tissues and not specific to erythropoiesis. Therefore it was not surprising that a genetic defect of the gene encoding N-acetylglucosaminyltransferase II, one of the candidates proposed for CDA II, was assigned to a different disease, congenital disorder of glycosylation type IIa (CDG-IIa), a severe multisystemic disorder that is clearly not related to CDA II [37].

Genetic issues in CDA II

Several glycosyltransferases contribute to the assembly of normal band 3 derived polylactosamines (Fig.2). Based on the structural data of erythrocyte membrane derived oligosaccharides of CDA II patients, early Golgi processing steps have been in the focus of interest but no defect in the coding genes could be elucidated [38]. The interaction between glycosyltransferases is complex and to a great extent unknown. This fact encouraged us to investigate additional glycosyltransferases either known to influence polylactosamine synthesis in cellular models [39, 40] or known to be directly involved in the assembly of polylactosamines (Fig.2).

The coding sequences of i-N-acetylglucosaminyltransferase (i-GnT, B3GNT6, NM_006876), N-acetylglucosaminyltransferase V (GnTV, MGAT5, NM_002410), galactosyltransferase V (GalTV, B4GALT5, NM_004776) and fucosyltransferase VIII (FuT8, FUT8, NM_178155) of a typical CDA II patient were sequenced using cDNA derived from lymphocyte-RNA as a template. No mutation was found in the coding sequence of i-GnT transferring N-acetylglucosamine (GlcNAc) in β 1,3-linkage to galactose, essential for polylactosamine synthesis [41], FuT8, the only known enzyme transferring fucose to the first GlcNAc attached to an asparagine of the protein [42], GalTV, a β 1,4-galactosyltransferase expressed in bone marrow [43], and GnTV, transferring GlcNAc in β 1,6 linkage to the α 1,6-branch of the

mannose core and playing a crucial role in the regulation of polylectosamine synthesis in some cell culture models [39].

A defect in I-N-acetylglucosaminyltransferase (GCNT2), responsible for the branching of polylectosamines and the creation of the I-antigen, was recently found to be the cause of the adult i-phenotype, an inherited disease clearly different from CDA II [44].

Since over a period of 30 years biochemical studies did not clearly reveal a candidate gene, in 1997 Gasparini et al. performed a genome wide linkage analysis of twelve Italian families and one French family suffering from CDA II with the typical clinical and biochemical picture of the disorder. A candidate region was elucidated on chromosome 20q11.2, termed CDAN2 locus spanning 5 cM [45]. No gene known to be involved in glycosylation is located within this area. Sequencing of candidate genes within this area performed by the same group did not show any mutation [46].

Later on, families of Italian and other origin were investigated and did not show association to 20q11.2 [20, 47, 48] and a founder effect was discussed [49]. At least 10% of CDA II patients do not show linkage to the mapping area and the authors suggest that CDA II would be a heterogeneous disorder [9].

Since then, the location of the markers on chromosome 20 found to have the highest LOD score in CDA II were changed and corrected in the current contigs (build 36.3) indicating that the CDAN2 locus might be on Chromosome 20 but is presumably different from the locus proposed in 1997; a fact that might also explain the exclusion of the locus in some typical CDA II patients [45] (Fig. 3).

In 2003, Paw et al described dyserythropoiesis in zebrafish as a sequel of mutations in the gene *slc4a1*, the band 3 analogon in zebrafish [50]. The fish shows anemia and double membranes of some erythrocytes comparable to CDA II patients. It remains questionable if zebrafish are good models for red blood cell disorders since - unlike mature mammalian

erythrocytes - fish erythrocytes remain nucleated. However, the fish model implicates, that mutations in band 3 or binding partners of band 3 might cause dyserythropoiesis. Although mutations in the gene coding for band 3 are known to cause severe spherocytosis with distal tubular acidosis [51] specific mutations might change the phenotype. Thus Perrota et al performed a haplotype analysis of the gene locus coding for band 3 (17q21-q22) and analysis of band 3 protein on SDS-PAGE to address the question whether band 3 alterations may cause CDA II in patients not associated with the 20q11.2 locus, but did not find a genetic linkage nor abnormalities of the band 3 protein [48].

Diagnostics of CDA II

The diagnosis of CDA II is typically derived from a bone marrow cytology showing the characteristic changes of erythroblasts described above. Due to the early description of increased hemolysis of CDA II erythrocytes under acidified conditions and after the addition of selected donor sera (acidified serum test, resulting in the synonymous term HEMPAS, hereditary erythroblastic multinuclearity with acidified serum test [52]), hemolysis induced by established donor sera is used to verify the diagnosis in specialized laboratories. Approximately 30% of randomized donor sera are able to lyse CDA II erythrocytes under acidified conditions but never the patients' own sera [52]. However, the test has a great variability in different laboratories and the sensitivity as well as specificity of the test is rather poor.

Some laboratories use antibodies for the i-antigen in order to prove the diagnosis of CDA II. While the presence of i-antigen consisting of linear polylactosamines is physiologic in healthy newborns, it is subsequently altered to branched polylactosamines coding for the I-antigen resulting in an adult I-antigen status after 18 month of life [53, 54]. It is well established, that

there is an increased amount of i-antigen on erythrocytes of CDA II patients, resulting in an increased aggregation after addition of anti-i-antibodies. Sensitivity seems to be good in a series of 45 CDA II patients [6]. The main pitfall may be that increased presentation of the i-antigen is also present in other disorders going along with increased erythrocyte turnover that might be a differential diagnosis to CDA II [55]. In addition, it has to be considered that another rare inherited disorder, the so called adult i-phenotype with persistence of the i-antigen is known, caused by a defect in a specific glycosyltransferase [44].

An apparent doubling of the cell membrane of some erythrocytes of CDA II patients was found as a typical feature in CDA II. As mentioned above, the doubling is due to residual membranes of endoplasmic reticulum that normally is eliminated during erythropoiesis [31]. Thus, electron microscopy studies of CDA II erythrocytes might be helpful for the diagnosis of CDA II. However, sensitivity and specificity of this phenomenon are unknown, especially with respect to other disorders affecting erythropoiesis.

Another test for CDA II is based on the detection of endoplasmic reticulum proteins in membrane preparations of erythrocytes using SDS-PAGE. Alloisio et al. used calreticulin antibodies to detect this ER specific protein in erythrocytes, demonstrating the presence in each of 20 CDA II patients but not in healthy controls, other types of anemia and obligatory heterozygous gene carriers suggesting that western blot analysis of calreticulin or other ER-markers from erythrocyte ghosts is a good and reliable diagnostic marker for CDA II [31].

Already in the first years after the first description of CDA II as a distinct entity, an altered mobility of band 3 (anion exchange protein 1) and band 4.5 (glucose transporter 1) on SDS-PAGE was described [12]. This increased mobility of band 3 as well as the decreased band width on SDS-PAGE is used as a diagnostic criterion. This criterion is a reliable, indirect hint for decreased glycosylation of band 3 although the appraisal is subjective and sometimes ambiguous, so that a positive result alone is not sufficient for the diagnosis..

Recently, lectin studies using tomato-lectin (*Lycopersicon esculentum*) specific to branched polylectosamines were shown to be of good diagnostic value in CDA II. Due to the severe truncation of polylectosamines in CDA II erythrocytes, tomato-lectin does not bind to erythrocyte membranes after separation by SDS-PAGE and western blotting [17, 19]. Using this technique, we did not find false positive or false negative results in our series of 30 patients. The test cannot be used for newborns and children under 12 months of age, since tomato-lectin does not bind to erythrocyte membranes in these patients due to incomplete expression of the i-phenotype (false positive results). In addition, transfusion of erythrocytes within 3-4 months before the testing may result in false negative results.

Modern analytical methods like mass spectrometry were used to analyse the exact composition and structure of glycans derived from CDA II erythrocytes and might be suitable for the diagnosis of CDA II [15, 17, 22, 56]. However, the methods are too elaborate to be used as a routine diagnostic test and are restricted for scientific purposes.

Heimpel et al. proposed that the diagnosis of CDA II requires evidence of congenital anemia, ineffective erythropoiesis and typical bone marrow findings and at least one of the biochemical criteria: positive acidified serum test, typical abnormalities in SDS-PAGE of erythrocyte membranes or double membrane of late erythroblasts [6]. However, the availability of new, well established biochemical tests will expand these criteria in the future.

Conclusions, history and future perspective

The alteration of N-glycans of erythrocyte membrane proteins is well established in CDA II. In the late eighties, several glycosyltransferases were assayed in different CDA II patients and lower enzyme activities were described in single patients [24, 33, 34]. However, genetic analysis did not reveal any mutation in the genes coding for the proposed enzymes and in other glycosyltransferases known to contribute to the assembly of the affected N-glycan

attached to band 3 of erythrocyte membranes. Today, the initial assumption, that CDA II is a primary glycosylation disorder causing dyserythropoiesis has shifted towards the view that both, dyserythropoiesis and dysglycosylation, share a common genetic and pathophysiological origin. Consequently, in 1997 a linkage analysis was done linking the CDA II gene to chromosome 20q11.2 in the majority of CDA II patients [45]. Surprisingly, in the last ten years, the CDA II gene was not found in this area although several genes were sequenced but are obviously not affected [46].

Thus, 40 years after the classification of congenital dyserythropoietic anemias and ten years after the first mapping approach for CDA II, the molecular cause of CDA II remains unknown. The molecular elucidation of CDA II is considerably aggravated due to the limited availability of affected erythroblasts. Therefore, it is to be expected that in contrast to several congenital disorders of glycosylation where the molecular basis was identified on the basis of the structural data of N-glycans [57], the molecular basis of CDA II will be clarified in the near future using genetic screening tools or by finding single patients with informative deletions or crossing over that allow to pinpoint the chromosomal origin of CDA II.

Acknowledgements : The authors were supported by grants from BMBF and IMF.

References:

- [1] H. Heimpel, Congenital dyserythropoietic anemias: epidemiology, clinical significance, and progress in understanding their pathogenesis, *Ann Hematol* 83 (2004) 613-621.
- [2] H. Tamary, L. Shalmon, H. Shalev, A. Halil, D. Dobrushin, N. Ashkenazi, M. Zoldan, P. Resnitzky, M. Korostishevsky, B. Bonne-Tamir, R. Zaizov, Localization of the gene for congenital dyserythropoietic anemia type I to a <1-cM interval on chromosome 15q15.1-15.3, *Am J Hum Genet* 62 (1998) 1062-1069.
- [3] O. Dgany, N. Avidan, J. Delaunay, T. Krasnov, L. Shalmon, H. Shalev, T. Eidelitz-Markus, J. Kapelushnik, D. Cattan, A. Pariente, M. Tulliez, A. Cretien, P.O. Schischmanoff, A. Iolascon, E. Fibach, A. Koren, J. Rossler, M. Le Merrer, I. Yaniv, R. Zaizov, E. Ben-Asher, T. Olender, D. Lancet, J.S. Beckmann, H. Tamary, Congenital dyserythropoietic anemia type I is caused by mutations in codanin-1, *Am J Hum Genet* 71 (2002) 1467-1474.
- [4] H. Heimpel, K. Schwarz, M. Ebnother, J.S. Goede, D. Heydrich, T. Kamp, L. Plaumann, B. Rath, J. Roessler, O. Schildknecht, M. Schmid, W. Wuillemin, B. Einsiedler, R. Leichtle, H. Tamary, E. Kohne, Congenital dyserythropoietic anemia type I (CDA I): molecular genetics, clinical appearance, and prognosis based on long-term observation, *Blood* 107 (2006) 334-340.
- [5] H. Sandstrom, A. Wahlin, Congenital dyserythropoietic anemia type III, *Haematologica* 85 (2000) 753-757.
- [6] H. Heimpel, V. Anselstetter, L. Chrobak, J. Denecke, B. Einsiedler, K. Gallmeier, A. Griesshammer, T. Marquardt, G. Janka-Schaub, M. Kron, E. Kohne, Congenital dyserythropoietic anemia type II: epidemiology, clinical appearance, and prognosis based on long-term observation, *Blood* 102 (2003) 4576-4581.
- [7] M.N. Fukuda, HEMPAS. Hereditary erythroblastic multinuclearity with positive acidified serum lysis test, *Biochim Biophys Acta* 1455 (1999) 231-239.
- [8] A. Iolascon, V. Sabato, D. de Mattia, F. Locatelli, Bone marrow transplantation in a case of severe, type II congenital dyserythropoietic anaemia (CDA II), *Bone Marrow Transplant* 27 (2001) 213-215.

- [9] A. Iolascon, J. Delaunay, S.N. Wickramasinghe, S. Perrotta, M. Gigante, C. Camaschella, Natural history of congenital dyserythropoietic anemia type II, *Blood* 98 (2001) 1258-1260.
- [10] H. Heimpel, F. Wendt, Congenital dyserythropoietic anemia with karyorrhexis and multinuclearity of erythroblasts, *Helv Med Acta* 34 (1968) 103-115.
- [11] S.N. Wickramasinghe, Congenital dyserythropoietic anaemias: clinical features, haematological morphology and new biochemical data, *Blood Rev* 12 (1998) 178-200.
- [12] V. Anselstetter, H.J. Horstmann, H. Heimpel, Congenital dyserythropoietic anaemia, types I and II: aberrant pattern of erythrocyte membrane proteins in CDA II, as revealed by two-dimensional polyacrylamide gel electrophoresis, *Br J Haematol* 35 (1977) 209-215.
- [13] A.J. Baines, J.P. Banga, W.B. Gratzler, D.C. Linch, E.R. Huehns, Red cell membrane protein anomalies in congenital dyserythropoietic anaemia, type II (HEMP AS), *Br J Haematol* 50 (1982) 563-574.
- [14] J.R. Casey, D.M. Lieberman, R.A. Reithmeier, Purification and characterization of band 3 protein, *Methods Enzymol* 173 (1989) 494-512.
- [15] M.N. Fukuda, T. Papayannopoulou, E.C. Gordon-Smith, H. Rochant, U. Testa, Defect in glycosylation of erythrocyte membrane proteins in congenital dyserythropoietic anaemia type II (HEMPAS), *Br J Haematol* 56 (1984) 55-68.
- [16] A. Iolascon, G. D'Agostaro, S. Perrotta, P. Izzo, R. Tavano, B. Miraglia del Giudice, Congenital dyserythropoietic anemia type II: molecular basis and clinical aspects, *Haematologica* 81 (1996) 543-559.
- [17] J. Denecke, C. Kranz, M. Nimtz, H.S. Conradt, T. Brune, H. Heimpel, T. Marquardt, Characterization of the N-glycosylation phenotype of erythrocyte membrane proteins in congenital dyserythropoietic anemia type II (CDA II/HEMPAS), *Glycoconj J* 25 (2008) 375-382.
- [18] H. Erdmann, H. Heimpel, H. Buchta, [Positive acid serum test and elevated agglutinability by Anti-i in patients with congenital dyserythropoietic anemia], *Klin Wochenschr* 48 (1970) 569-570.

- [19] H. Kameh, C. Landolt-Marticorena, J.H. Charuk, H. Schachter, R.A. Reithmeier, Structural and functional consequences of an N-glycosylation mutation (HEMPAS) affecting human erythrocyte membrane glycoproteins, *Biochem Cell Biol* 76 (1998) 823-835.
- [20] E. Zdebska, A. Iolascon, J. Spychalska, S. Perrotta, C. Lanzara, G. Smolenska-Sym, J. Koscielak, Abnormalities of erythrocyte glycoconjugates are identical in two families with congenital dyserythropoietic anemia type II with different chromosomal localizations of the disease gene, *Haematologica* 92 (2007) 427-428.
- [21] E. Zdebska, E. Mendek-Czajkowska, R. Ploski, B. Woeniewicz, J. Koscielak, Heterozygosity of CDAN II (HEMPAS) gene may be detected by the analysis of erythrocyte membrane glycoconjugates from healthy carriers, *Haematologica* 87 (2002) 126-130.
- [22] E. Zdebska, E. Golaszewska, J. Fabijanska-Mitek, H. Schachter, H. Shalev, H. Tamary, H. Sandstrom, A. Wahlin, J. Koscielak, Glycoconjugate abnormalities in patients with congenital dyserythropoietic anaemia type I, II and III, *Br J Haematol* 114 (2001) 907-913.
- [23] E. Zdebska, V. Anselstetter, T. Pacuszka, R. Krauze, A. Chelstowska, H. Heimpel, J. Koscielak, Glycolipids and glycopeptides of red cell membranes in congenital dyserythropoietic anaemia type II (CDA II), *Br J Haematol* 66 (1987) 385-391.
- [24] M.N. Fukuda, A. Dell, P. Scartezzini, Primary defect of congenital dyserythropoietic anemia type II. Failure in glycosylation of erythrocyte lactosaminoglycan proteins caused by lowered N-acetylglucosaminyltransferase II, *J Biol Chem* 262 (1987) 7195-7206.
- [25] M.N. Fukuda, G.F. Gaetani, P. Izzo, P. Scartezzini, A. Dell, Incompletely processed N-glycans of serum glycoproteins in congenital dyserythropoietic anaemia type II (HEMPAS), *Br J Haematol* 82 (1992) 745-752.
- [26] E. Zdebska, M. Adamczyk-Poplawska, J. Koscielak, Glycophorin A in two patients with congenital dyserythropoietic anemia type I and type II is partly unglycosylated, *Acta Biochim Pol* 47 (2000) 773-779.
- [27] G. Hug, K.Y. Wong, B.C. Lampkin, Congenital dyserythropoietic anemia type II. Ultrastructure of erythroid cells and hepatocytes, *Lab Invest* 26 (1972) 11-21.
- [28] J. Breton-Gorius, M.T. Daniel, J.P. Clauvel, B. Dreyfus, [Ultrastructural abnormalities of erythroblasts and erythrocytes in 6 cases of congenital dyserythropoietic anemia], *Nouv Rev Fr Hematol* 13 (1973) 23-49.

- [29] M.N. Fukuda, G. Klier, P. Scartezzini, Congenital dyserythropoietic anaemia type II (HEMPAS): characterization of aberrant intracellular organelles by immunogold electron microscopy, *Br J Haematol* 67 (1987) 95-101.
- [30] W. Vainchenker, J. Guichard, J. Breton-Gorius, Morphological Abnormalities in cultured erythroid colonies (BFU-E) from the blood of two patients with HEMPAS, *Br J Haematol* 42 (1979) 363-369.
- [31] N. Alloisio, P. Texier, L. Denoroy, C. Berger, E. Miraglia del Giudice, S. Perrotta, A. Iolascon, F. Gilsanz, G. Berger, J. Guichard, The cisternae decorating the red blood cell membrane in congenital dyserythropoietic anemia (type II) originate from the endoplasmic reticulum, *Blood* 87 (1996) 4433-4439.
- [32] M.J. Koury, S.T. Sawyer, S.J. Brandt, New insights into erythropoiesis, *Curr Opin Hematol* 9 (2002) 93-100.
- [33] M.N. Fukuda, K.A. Masri, A. Dell, L. Luzzatto, K.W. Moremen, Incomplete synthesis of N-glycans in congenital dyserythropoietic anemia type II caused by a defect in the gene encoding alpha-mannosidase II, *Proc Natl Acad Sci U S A* 87 (1990) 7443-7447.
- [34] M.N. Fukuda, K.A. Masri, A. Dell, E.J. Thonar, G. Klier, R.M. Lowenthal, Defective glycosylation of erythrocyte membrane glycoconjugates in a variant of congenital dyserythropoietic anemia type II: association of low level of membrane-bound form of galactosyltransferase, *Blood* 73 (1989) 1331-1339.
- [35] D. Chui, M. Oh-Eda, Y.F. Liao, K. Panneerselvam, A. Lal, K.W. Marek, H.H. Freeze, K.W. Moremen, M.N. Fukuda, J.D. Marth, Alpha-mannosidase-II deficiency results in dyserythropoiesis and unveils an alternate pathway in oligosaccharide biosynthesis, *Cell* 90 (1997) 157-167.
- [36] M.N. Fukuda, HEMPAS disease: genetic defect of glycosylation, *Glycobiology* 1 (1990) 9-15.
- [37] J.H. Charuk, J. Tan, M. Bernardini, S. Haddad, R.A. Reithmeier, J. Jaeken, H. Schachter, Carbohydrate-deficient glycoprotein syndrome type II. An autosomal recessive N-acetylglucosaminyltransferase II deficiency different from typical hereditary erythroblastic multinuclearity, with a positive acidified-serum lysis test (HEMPAS), *Eur J Biochem* 230 (1995) 797-805.

- [38] A. Iolascon, E. Miraglia del Giudice, S. Perrotta, M. Granatiero, L. Zelante, P. Gasparini, Exclusion of three candidate genes as determinants of congenital dyserythropoietic anemia type II (CDA-II), *Blood* 90 (1997) 4197-4200.
- [39] S. Yousefi, E. Higgins, Z. Daoling, A. Pollex-Kruger, O. Hindsgaul, J.W. Dennis, Increased UDP-GlcNAc:Gal beta 1-3GalNAc-R (GlcNAc to GalNAc) beta-1, 6-N-acetylglucosaminyltransferase activity in metastatic murine tumor cell lines. Control of polylactosamine synthesis, *J Biol Chem* 266 (1991) 1772-1782.
- [40] A.K. Chakraborty, J. Pawelek, Y. Ikeda, E. Miyoshi, N. Kolesnikova, Y. Funasaka, M. Ichihashi, N. Taniguchi, Fusion hybrids with macrophage and melanoma cells up-regulate N-acetylglucosaminyltransferase V, beta1-6 branching, and metastasis, *Cell Growth Differ* 12 (2001) 623-630.
- [41] K. Sasaki, K. Kurata-Miura, M. Ujita, K. Angata, S. Nakagawa, S. Sekine, T. Nishi, M. Fukuda, Expression cloning of cDNA encoding a human beta-1,3-N-acetylglucosaminyltransferase that is essential for poly-N-acetyllactosamine synthesis, *Proc Natl Acad Sci U S A* 94 (1997) 14294-14299.
- [42] Y. Yamaguchi, Y. Ikeda, T. Takahashi, H. Ihara, T. Tanaka, C. Sasho, N. Uozumi, S. Yanagidani, S. Inoue, J. Fujii, N. Taniguchi, Genomic structure and promoter analysis of the human alpha1, 6-fucosyltransferase gene (FUT8), *Glycobiology* 10 (2000) 637-643.
- [43] K. Furukawa, T. Sato, Beta-1,4-galactosylation of N-glycans is a complex process, *Biochim Biophys Acta* 1473 (1999) 54-66.
- [44] L.C. Yu, Y.C. Twu, C.Y. Chang, M. Lin, Molecular basis of the adult i phenotype and the gene responsible for the expression of the human blood group I antigen, *Blood* 98 (2001) 3840-3845.
- [45] P. Gasparini, E. Miraglia del Giudice, J. Delaunay, A. Totaro, M. Granatiero, S. Melchionda, L. Zelante, A. Iolascon, Localization of the congenital dyserythropoietic anemia II locus to chromosome 20q11.2 by genomewide search, *Am J Hum Genet* 61 (1997) 1112-1116.
- [46] C. Lanzara, R. Ficarella, A. Totaro, X. Chen, R. Roberto, S. Perrotta, C. Lasalandra, P. Gasparini, A. Iolascon, M. Carella, Congenital dyserythropoietic anemia type II: exclusion of seven candidate genes, *Blood Cells Mol Dis* 30 (2003) 22-29.

- [47] A. Beauchamp-Nicoud, P.O. Schischmanoff, N. Alloisio, P. Boivin, S.F. Parsons, F. Mielot, G. Tchernia, A. Legrand, E. Miraglia Del Giudice, P. Gasparini, A. Iolascon, S.N. Wickramasinghe, J. Delaunay, Suppression of CDA II expression in a homozygote, *Br J Haematol* 106 (1999) 948-953.
- [48] S. Perrotta, L. Luzzatto, M. Carella, A. Iolascon, Congenital dyserythropoietic anemia type II in human patients is not due to mutations in the erythroid anion exchanger 1, *Blood* 102 (2003) 2704-2705.
- [49] A. Iolascon, V. Servedio, R. Carbone, A. Totaro, M. Carella, S. Perrotta, S.N. Wickramasinghe, J. Delaunay, H. Heimpel, P. Gasparini, Geographic distribution of CDA-II: did a founder effect operate in Southern Italy?, *Haematologica* 85 (2000) 470-474.
- [50] B.H. Paw, A.J. Davidson, Y. Zhou, R. Li, S.J. Pratt, C. Lee, N.S. Trede, A. Brownlie, A. Donovan, E.C. Liao, J.M. Ziai, A.H. Drejer, W. Guo, C.H. Kim, B. Gwynn, L.L. Peters, M.N. Chernova, S.L. Alper, A. Zapata, S.N. Wickramasinghe, M.J. Lee, S.E. Lux, A. Fritz, J.H. Postlethwait, L.I. Zon, Cell-specific mitotic defect and dyserythropoiesis associated with erythroid band 3 deficiency, *Nat Genet* 34 (2003) 59-64.
- [51] M.L. Ribeiro, N. Alloisio, H. Almeida, C. Gomes, P. Texier, C. Lemos, G. Mimoso, L. Morle, F. Bey-Cabet, R.C. Rudigoz, J. Delaunay, G. Tamagnini, Severe hereditary spherocytosis and distal renal tubular acidosis associated with the total absence of band 3, *Blood* 96 (2000) 1602-1604.
- [52] J.H. Crookston, M.C. Crookston, K.L. Burnie, W.H. Francombe, J.V. Dacie, J.A. Davis, S.M. Lewis, Hereditary erythroblastic multinuclearity associated with a positive acidified-serum test: a type of congenital dyserythropoietic anaemia, *Br J Haematol* 17 (1969) 11-26.
- [53] W.L. Marsh, Anti-i: a cold antibody defining the Ii relationship in human red cells, *Br J Haematol* 7 (1961) 200-209.
- [54] W.L. Marsh, M.E. Nichols, M.E. Reid, The definition of two I antigen components, *Vox Sang* 20 (1971) 209-217.
- [55] J.M. Navenot, J.Y. Muller, D. Blanchard, Expression of blood group i antigen and fetal hemoglobin in paroxysmal nocturnal hemoglobinuria, *Transfusion* 37 (1997) 291-297.

[56] M.N. Fukuda, B. Bothner, P. Scartezzini, A. Dell, Isolation and characterization of poly-N-acetyllactosaminylceramides accumulated in the erythrocytes of congenital dyserythropoietic anemia type II patients, *Chem Phys Lipids* 42 (1986) 185-197.

[57] T. Marquardt, J. Denecke, Congenital disorders of glycosylation: review of their molecular bases, clinical presentations and specific therapies, *Eur J Pediatr* 162 (2003) 359-379.

ACCEPTED MANUSCRIPT

Legend:

Fig.1:

Characteristic changes in red blood cells and bone marrow in HEMPAS. A) bone marrow smear showing bi- and multinuclear erythroblasts and hypercellularity. B) Double membrane of erythrocytes due to residual endoplasmic reticulum. C) Erythrocyte ghost extracts analyzed by SDS-PAGE show that CDA II band 3 is sharper than control band 3 due to truncated N-glycans. D) A tomato lectin blot of the same gel as in (C) shows that the lectin does not bind to erythrocyte glycoproteins in CDA II patients..

Fig.2: Oligosaccharides of Band 3. Crucial Golgi enzymes for the assembly of normal poly-lactosamines in the Golgi

Assembly of the precursor oligosaccharide shown on the left is carried out in the endoplasmic reticulum. This glycan is transported to the Golgi apparatus for further processing to the glycan shown on the right. Three Man residues are cleaved by α ManI (1), a GlcNAc is attached to the Man- α -1,3 branch by GnTI (2), two Man residues on the Man α 1,6 branch are cleaved by α -ManII (3), and a second GlcNAc is attached to the Man α 1,6 branch by GnT-II (4).

In some glycans, FuT8 now attaches a fucose in α 1,6 linkage to the core GlcNAc (5). Elongation of the oligosaccharide is performed in the trans-Golgi probably by several β 1,4-galactosyltransferases (6) and i-GnT (7) resulting in linear poly-lactosamines with variable length (i-antigen). Branching of linear poly-lactosamines by adding a GlcNAc in β 1,6- linkage

to galactose of the linear polylectosamines (I-GnT, 8) and further elongation of this GlcNAc by β 1,4-galactosyltransferases (6) leads to the expression of the I-antigen. Sialic acid and oligosaccharides determining blood group characteristics are usually attached to terminal galactose of band 3 polylectosamines (r). The so called “bisecting” GlcNAc may be attached to the β -linked Man of the trimannosyl core by GnT III in the median Golgi (9)

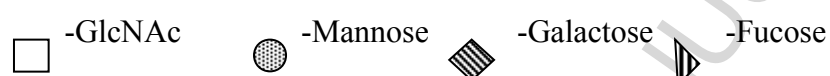

Fig.3:

Localization of deCODE markers in the mapping area of CDAN2 at the time of mapping (above) and according to the present contig (below). White boxed markers showed highest LOD-scores.

Abbreviations:

GnTI, UDP-N-acetylglucosamine: α -3-D-mannoside β -1,2-N-acetylglucosaminyltransferase I; GnTII, UDP-N-acetylglucosamine: α -6-D-mannoside β -1,2-N-acetylglucosaminyltransferase I; FuTVIII, GDP-L-Fucose:N-acetyl-beta-D-glucosaminide:alpha-1-6 fucosyltransferase; GnT-III: UDP-N-acetylglucosamine: β -D-mannoside β -1,4-N-acetylglucosaminyltransferase ;GnT-IV: UDP-N-acetylglucosamine: α 1,3-D-mannoside β 1,4-N-acetylglucosaminyltransferase; GnT-V, UDP-N-acetylglucosamine: α 1,6-D-mannoside β 1,6-N-acetylglucosaminyltransferase; β 1,4-GalT, UDP-galactose: β -D-N-acetylglucosaminide β 1,4-galactosyltransferase; α ManI, α -mannosidase I; α ManII, α -mannosidase II; GlcNAc, N-acetylglucosamine; Man, mannose; Gal, galactose; iGnT, UDP-N-acetylglucosamine: β -1,4-D-galactoside β 1,3-N-

acetylglucosaminyltransferase; IGnT, UDP-N-acetylglucosamine:β-1,4-D-galactoside β-1,6-N-acetylglucosaminyltransferase

ACCEPTED MANUSCRIPT

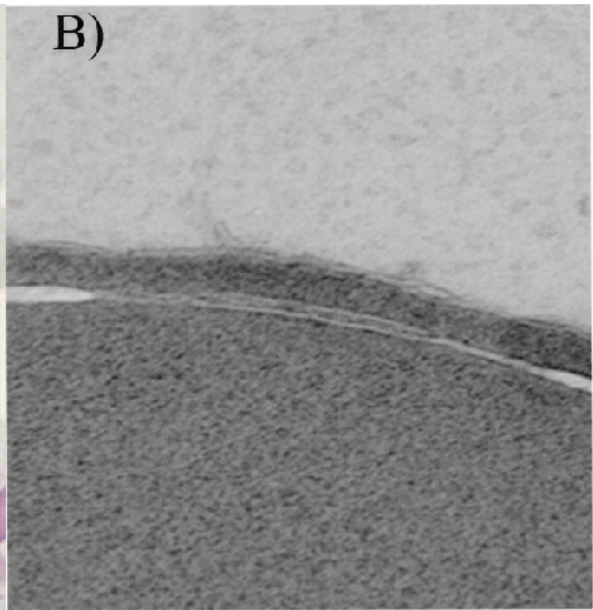
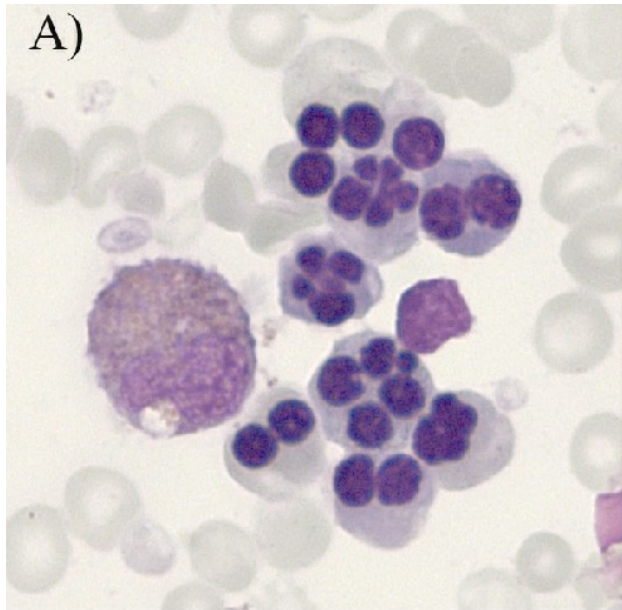

C) CDAII Control

D) CDAII Control

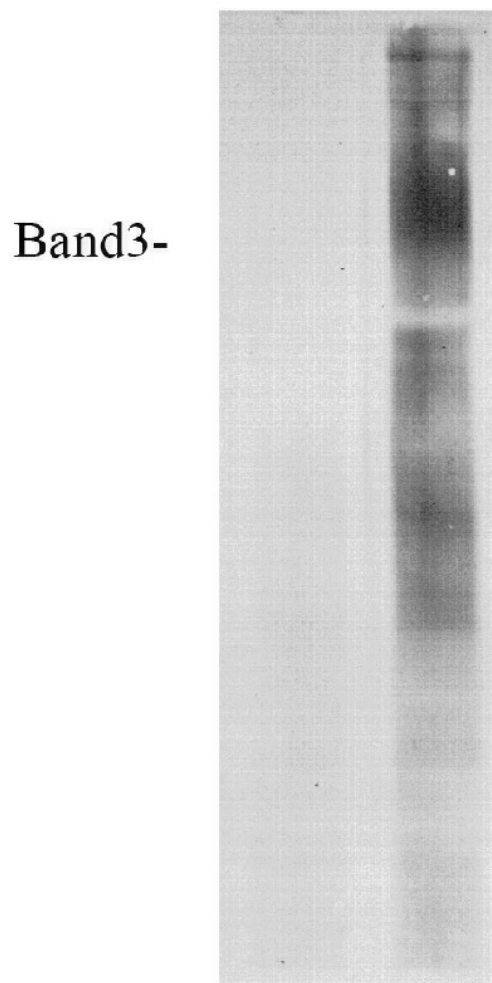
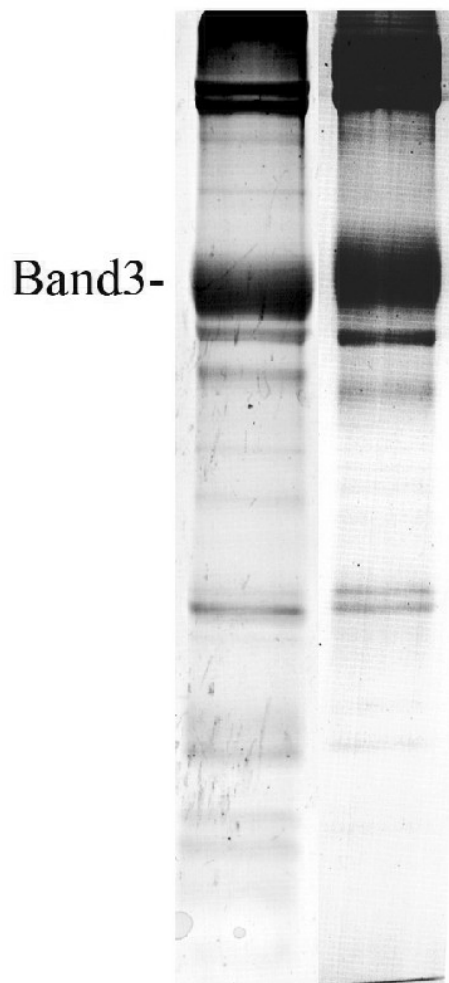

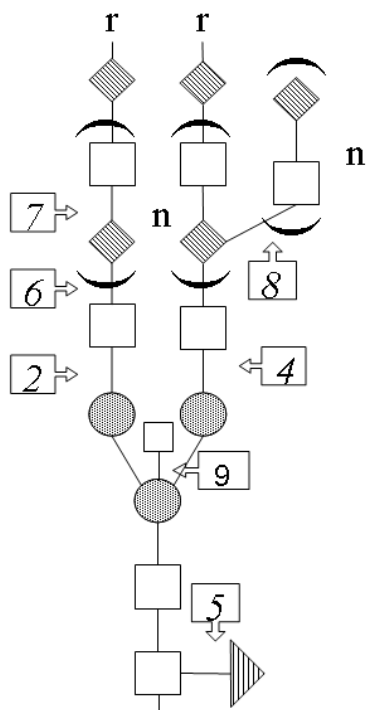
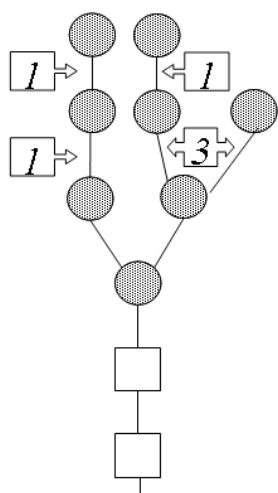

ACCEP

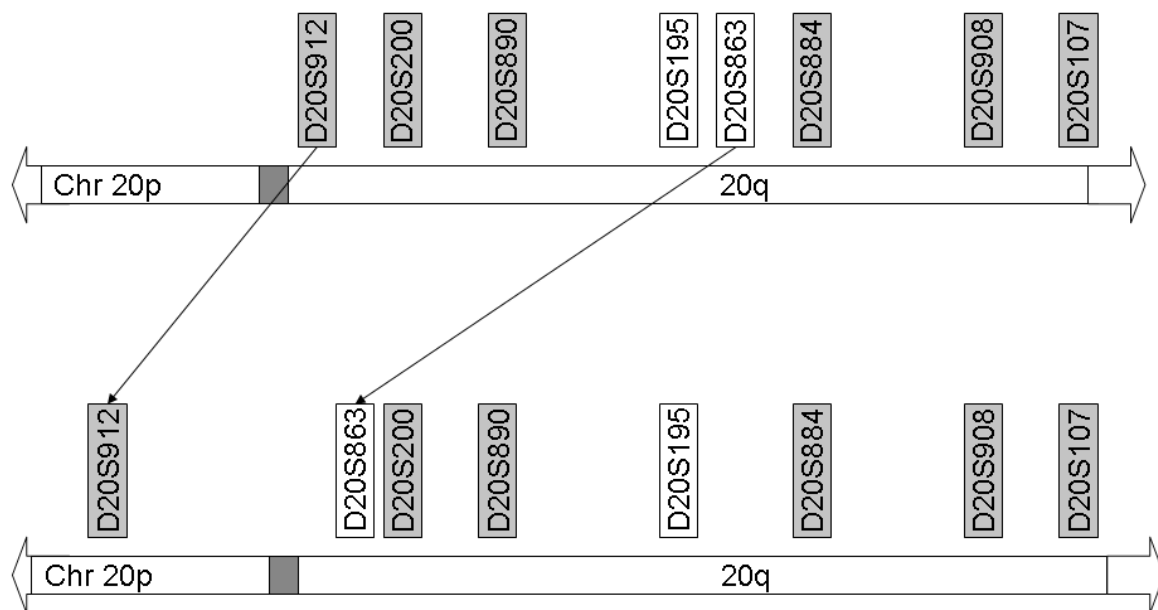

ACCEP