



HAL
open science

Modeling of sharp indentation experiments - some fundamental issues

Per-Lennart Larsson

► **To cite this version:**

Per-Lennart Larsson. Modeling of sharp indentation experiments - some fundamental issues. Philosophical Magazine, 2006, 86 (33-35), pp.5155-5177. 10.1080/14786430600589089 . hal-00513662

HAL Id: hal-00513662

<https://hal.science/hal-00513662v1>

Submitted on 1 Sep 2010

HAL is a multi-disciplinary open access archive for the deposit and dissemination of scientific research documents, whether they are published or not. The documents may come from teaching and research institutions in France or abroad, or from public or private research centers.

L'archive ouverte pluridisciplinaire **HAL**, est destinée au dépôt et à la diffusion de documents scientifiques de niveau recherche, publiés ou non, émanant des établissements d'enseignement et de recherche français ou étrangers, des laboratoires publics ou privés.



Modeling of sharp indentation experiments - some fundamental issues

Journal:	<i>Philosophical Magazine & Philosophical Magazine Letters</i>
Manuscript ID:	TPHM-05-Nov-0504.R2
Journal Selection:	Philosophical Magazine
Date Submitted by the Author:	12-Jan-2006
Complete List of Authors:	Larsson, Per-Lennart; Royal Institute of Technology, KTH Solid Mechanics
Keywords:	modelling, constitutive equations, contact mechanics, FEM, indentation
Keywords (user supplied):	



Modeling of sharp indentation experiments - some fundamental issues

Per-Lennart Larsson
KTH Solid Mechanics
Royal Institute of Technology
SE-10044, Stockholm
Sweden
Email: pelle@half.kth.se
Phone: +46-8-7907540

Abstract

A relevant interpretation of sharp indentation experiments requires a fundamental understanding of the mechanics involved in the process. Such understanding can only be achieved if an appropriate mechanical model is used in order to describe the problem. These models can in rare cases be purely analytical but nowadays numerical modeling is also a vital part of a mechanical approach. Furthermore, with the development of new materials and also nanoindentation devices, material (constitutive) modeling becomes very important. The aim of the present paper is first of all to present an overview of the state of the art of modeling of sharp indentation experiments. In particular indentation of classical Mises elastoplastic behaviour but also modeling of indentation of other types of materials will be touched upon. In addition, some fundamental issues of substantial importance at indentation modeling will be discussed. These issues include 1) the influence from large deformations, 2) differences and similarities between cone and pyramid indentation results, 3) the influence from residual stresses, 4) the effective elastic modulus at indentation and 5) differences and similarities between indentation and scratch results. Most of the results presented in these discussions have been published previously in international journals but the implications of these results have, in the authors opinion, not been fully appreciated by the indentation community, or at least not sufficiently discussed.

1. Introduction. Historical background.

Sharp indentation, or hardness, tests, associated with names like Knoop, Vickers and Berkovich, have for a long time been used for characterization of conventional engineering materials such as metals and alloys. In recent years, such tests have received increasing attention and appreciation due to the development of new experimental devices like the nanoindenter, Pethica et al. [1], enabling an experimentalist to determine the material properties from extremely small samples of the material. Another reason for the renewed interest in indentation testing is due to the fact that for many new engineering materials like ceramics, a standard uniaxial test often fails to deliver reliable results and, accordingly, indentation is the only alternative for material characterization. Furthermore, indentation is a very convenient tool for determining the material properties of thin films or strings in ready-to-use engineering devices.

The most important quantities given by an indentation test are the hardness H , here and in the sequel interpreted as the mean contact pressure, the contact area A or alternatively, the relation

between indentation load, P , and indentation depth, h , during loading as well as unloading. These quantities can then be used in order to determine the constitutive properties of the material by taking advantage of results from earlier theoretical and experimental analyses by Tabor [2], Johnson [3], [4], Doerner and Nix [5] and Oliver and Pharr [6]. Johnson [3], [4] also suggested that the outcome of a sharp indentation test on elastic-plastic materials will fall into one out of three different levels, depending on the material properties and the type of indenter used, as shown schematically in Fig. 1 where the normalized hardness, $\bar{H} = H/\sigma_r$, is depicted as function of the parameter

$$\Gamma = \frac{E \tan \beta}{(1 - \nu^2) \sigma_y}. \quad (1)$$

In Fig. 1, E is Young's modulus, ν is Poisson's ratio, σ_y is the flow stress at first yield, σ_r is the flow stress at a representative value of the plastic strain, a concept first suggested by Tabor [2] to be discussed in detail below (note that $\sigma_r = \sigma_y$ at perfect plasticity), and β is the angle between the sharp indenter and the undeformed surface of the material, see Fig. 2. As indicated above for materials with appreciable strain-hardening a better correlation with the schematic curve in Fig. 1 is given if σ_y in eq. (1) is replaced by some stress level, most frequently σ_r , representing the stress-strain characteristics at higher values of the plastic strain. This parameter will here and in the sequel be denoted Γ_h and explicitly defined as

$$\Gamma_h = \frac{E \tan \beta}{(1 - \nu^2) \sigma_r}. \quad (2)$$

In short, the three levels shown in Fig. 1 can be characterized as follows; In level I, $\Gamma, \Gamma_h < 3$, very little plastic deformation occurs during the indentation test and all global properties can be derived by an elastic analysis. In level II, $3 < \Gamma, \Gamma_h < 30$, an increasing amount of plastic deformation is present and both the elastic and the plastic properties of the material will influence the outcome of a hardness test. Johnson [3], [4] suggested, based on the fact that, in such a situation, the stress field just beneath the indenter is almost hydrostatic, that the process was very similar to the case of expansion of a spherical cavity in a large solid due to an internal pressure and derived the formula

$$H = \frac{2}{3} \sigma_r \left(1 + \ln \frac{E \tan \beta}{3(1 - \nu^2) \sigma_y} \right) \quad (3)$$

for the hardness. Finally then, in level III, $\Gamma, \Gamma_h > 30$, plastic deformation is present all over the contact area and elasticity no longer influences the hardness value for the material. This is also the region pertinent to most standard engineering materials, such as steel, many aluminiums and copper just to mention a few. By analysing the results from a number of experiments Tabor [2] concluded that the hardness in level III could be derived from the simple formula

$$H = C \sigma_r \quad (4)$$

where C is a constant that only depends on the geometry of the sharp indenter while, as mentioned above, σ_r is the representative flow stress at a representative value of the effective accumu-

lated plastic strain, ϵ_p . Based on experimental results Tabor [2] also suggested the values $C \approx 3$ and $\epsilon_p \approx 0.08$ for a Vickers indenter while Atkins and Tabor [7] found $C \approx 2.54$ and $\epsilon_p \approx 0.11$ for a cone indenter with an angle of 22° between the indenter and the undeformed surface. In this context it should also be mentioned that the representative stress used by Johnson [3], [4] in eq. (3) is essentially defined in the same way as proposed by Tabor [2].

It seems appropriate to here also point out that in case of classical elastoplastic material behaviour the indentation problem is self-similar with no characteristic length present neither in the governing equations nor in the boundary conditions. Consequently, the hardness, $H=P/A$, as well as a ratio h/\sqrt{A} , will be constant during the loading sequence of an indentation test and stresses and strains will be functions of the dimensionless variable x_i/\sqrt{A} (x_i being Cartesian coordinates as shown in Fig. 2), and material properties, alone. In this context, \sqrt{A} should be interpreted as a characteristic contact length. As a result, the indentation load and the contact area are directly proportional to the square of the indentation depth according to

$$\left. \begin{aligned} P &= g_1 h^2 \\ A &= g_2 h^2 \end{aligned} \right\}, \quad (5)$$

with the functions g_1 and g_2 depending only on the geometry of the indenter and the constitutive properties of the indented material. Clearly, eq. (5), and also the fact that H is constant during a sharp indentation test, fails at for example strain gradient material behaviour as then a characteristic length is present in the constitutive equation, cf. e. g. Fleck and Hutchinson [8].

To conclude then this historical background, eqs. (3) and (4) have been used extensively in order to determine the elastic-plastic material properties of a material from a simple hardness test yielding results of, for many applications, sufficient accuracy. However, with the development of modern computers and new numerical methods it has been possible to investigate the region of validity for the above-mentioned formulae in some more detail (and of course also improve upon) by computational simulations of indentation of materials with tailored constitutive properties and this issue will be discussed in the following section of the paper.

From the discussion above it is hopefully clear that (mechanical) modeling of indentation experiments is of fundamental importance when the experimental results are to be interpreted. Above, only classical elastoplastic materials have been touched upon but this is of course also true for other types of materials. Indeed, the development of the nanoindenter have strongly indicated the need for a better understanding of so called nonlocal (strain gradient) materials as such effects are very much present at, say, submicrometer indentation. **Partly as a consequence of this fact, already in 1993 Fleck and Hutchinson [8] presented a phenomenological constitutive theory for strain gradient plasticity and further progress as regards this issue was made by Gao et al. [9] and Huang et al. [10]. In these two latter articles a mechanism-based strain gradient plasticity theory, taken directly from the Taylor dislocation model, was developed and applied in order to study the inden-**

1
2
3
4
5
6
7
8
9
10
11
12
13
14
15
16
17
18
19
20
21
22
23
24
25
26
27
28
29
30
31
32
33
34
35
36
37
38
39
40
41
42
43
44
45
46
47
48
49
50
51
52
53
54
55
56
57
58
59
60

tation size effect as will be discussed somewhat more below (a simplification of the theory developed in [9] and [10] was also suggested by Huang et al. [11]).

Basically, mechanical modeling of indentation can (in the authors opinion) be divided into three subgroups, namely 1) *indentation modeling*, 2) *numerical modeling* and 3) *material modeling*. *Indentation modeling* concerns analytical, semi-empirical or empirical modeling of the relation between global or local indentation quantities and, most often, constitutive parameters. The discussion above related to elastoplastic materials is a good example of this feature. *Numerical modeling* obviously concerns the numerics involved when attacking indentation problems. Since the early 1970's numerical modeling has mainly been focused on the finite element method but nowadays also methods pertinent to atomistic or quasicontinuum approaches, cf. e.g. Shenoy et al. [12], are of interest. Finally, *material modeling* concerns appropriate constitutive models for an accurate analysis of indentation problems. Obviously, *numerical* and *material modeling* concern very general aspects of many different research areas and for this reason the main interest here will be focused on *indentation modeling*.

The aim of the present paper is to present first of all an overview of recent advances in indentation modeling of, in particular, classical elastoplastic materials but also a more general discussion about indentation modeling of other types of materials. With this as a background, some fundamental issues of substantial importance at indentation modeling will be discussed in detail. These issues include 1) the influence from large deformations, 2) differences and similarities between cone and pyramid indentation results, 3) the influence from residual stresses, 4) the effective elastic modulus at indentation and 5) differences and similarities between indentation and scratch results. It is the authors opinion that substantial knowledge do exist about these important issues but this has not yet been fully appreciated by the indentation community or, at least, further discussions and clarifications are needed. Hopefully, the present article can make a contribution in this respect.

It should be clearly stated that this is not by any means intended to be a complete overview of the state of the art of indentation modeling. There exist in the literature a large amount of similar articles, cf. e. g. Cook and Pharr [13], Lopez [14], Söderlund and Rowcliffe [15], Lawn [16], Oliver and Pharr [17] and Cheng and Cheng [18], discussing different aspects of indentation and, instead, here only some fundamental issues, as listed above, related to indentation modeling will be scrutinized. For clarity and convenience, the discussion is limited to sharp indentation exemplified by Vickers and cone indenters as shown in Fig. 2. In this content it should be mentioned that indentation using the Berkovich indenter, as most often is the case at nanoindentation, show very strong similarities with Vickers indentation, cf. e. g. Larsson [19], and for this reason essentially no distinction will be made in the discussion below between these two types of indenters.

2. Recent advances in indentation modeling of (elastoplastic) materials.

It is hopefully clear from the discussion above that in the past much knowledge has been gained as regards the relation between global indentation properties and material parameters at classical elastoplastic material behaviour. The relations (3) and (4) given by Johnson [3], [4] and Tabor [2] are in many cases very accurate and can be used with confidence at material characterization. In

particular so when the strain-hardening behaviour is regular and can be well approximated by a power law function, cf. e. g. Dao et al. [20] and Larsson [19].

Indentation modeling of materials with a more irregular strain-hardening behaviour is of course more involved but also in this case much is known. For level II indentation, Giannakopoulos et al. [21] and Larsson et al. [22] analysed Vickers and Berkovich indentation of elastic-plastic materials, by using finite element methods, and found that, for many materials of practical interest, high accuracy could only be achieved, when using an equation with the same form as eq. (3), by describing the hardness with two strain-hardening parameters (or representative stresses). In short, leaving out details about the deformation at the contact boundary, very good agreement with numerical and experimental results were found when the representative flow stress $\sigma_r(\epsilon_r = 0.08)$ in eq. (3) were replaced by a two-parameter characterization ($\sigma_y + \sigma_r(\epsilon_r = 0.3)$), $\sigma_r(\epsilon_r = 0.3)$ being the flow stress at 30% plastic strain. In addition, according to Giannakopoulos et al. [21] and Larsson et al. [22], the constant $2/3$ (in eq. (3), should be replaced by the values 0.29, for Vickers, and 0.27, for Berkovich, as determined from the numerical calculations. Early numerical investigations of cone indentation have also been performed, cf. e.g. Bhattacharya and Nix [23], [24], and Laursen and Simo [25], but these studies have not addressed in detail the issue of the accuracy of eq. (3) and (4) save for the case of level II indentation of perfectly plastic materials, Bhattacharya and Nix [23].

As regards detailed numerical studies of level III indentation this was performed later by Larsson [19]. Here, it was shown again that, when materials with an irregular strain-hardening behaviour are at issue, using a two-parameter description at level III conditions yielded very good agreement between experimental results and analytical/numerical predictions for both cone and Vickers/Berkovich indenters. In short, Larsson [19] suggested a relation (based on an extensive amount of FEM calculations)

$$H = C_1 \sigma_l + C_2 \sigma_h, \quad (6)$$

between the material hardness and strain-hardening characteristics of the indented material. In (5), C_1 and C_2 are constants depending only on the shape of the indenter and σ_l , σ_h are yield stresses at different values on the plastic strain.

It seems appropriate to emphasize here that eventhough these two-parameter descriptions discussed above produce very accurate results they have less practical value at material characterization (obviously because there are two representative stress values involved). They are, however, of importance in other situations when, for example, determination of residual stresses is of concern, cf. e. g. Carlsson and Larsson [26], [27], as in such a case the material (strain-hardening) behaviour is known and the crucial issue concerns high accuracy relations between hardness and (representative) stress values.

Hardness values alone, however, are not sufficient for a complete characterization of a material using sharp indentation and further information and indentation modeling is necessary. For this purpose it is convenient to introduce the indentation parameter (the relative contact area)

$$c^2 = \frac{A}{A_{nom}}, \quad (7)$$

A_{nom} being the nominal contact area resulting if the material neither sinks-in nor piles-up along the contact boundary. Obviously, if $c^2 < 1$ the resulting contact area is smaller than what could be expected from purely geometrical considerations (sinking-in) and the other way around if $c^2 > 1$ (piling-up). From the discussion above it can also be concluded that for a particular indenter geometry, c^2 is (as the hardness) a function of the material properties alone. It should be noted in passing that the P - h -relation can of course also be used to extract information related to material characterization but this information is (during the loading sequence of an indentation experiment) not independent of the information given by hardness and c^2 values.

Indentation modeling of the parameter c^2 is in many ways a much tougher task than trying to determine a relation between the material hardness and constitutive parameters. The reason for this is evident from Fig. 3, taken from Carlsson and Larsson [26], where it is shown that elastic effects are much more pronounced for this parameter and a truly rigid-plastic solution is only achieved at very high values on the Johnson parameter Γ (or Γ_h). This feature certainly complicates indentation modeling as obviously the parameter dependence of c^2 is more involved (for most materials) than for the hardness. However, in recent years there has been a rapid development of modeling tools such as advanced dimensional analysis (scaling), cf. e. g. Cheng and Cheng [18], and numerical methods, in particular then the finite element method. Based on such methods it is possible to perform by using FEM very comprehensive parameter studies, guided by dimensional analysis, with pertinent tailoring of the relevant material properties, in order to determine accurate relations between global indentation properties and material parameters. In short, modern modeling tools make it possible to perform advanced, comprehensive curve-fitting or reverse modeling which are necessary methods of analysis remembering that the resulting boundary problem is too complicated to be attacked by analytical methods.

Based on the above discussed procedure a number of interesting studies have been presented. This can be very well exemplified by the work by Mata [28]. Here comprehensive but straightforward general relations between global indentation variables (hardness and relative contact area) and material properties (for classical elastoplastic materials) were presented and used for determination of uniaxial stress-strain curves. Very good correlation with uniaxial test results was found, see Fig. 4, and these results, and similar ones presented in the literature, indicate that curve-fitting or reverse methods can be used with some definite confidence when material characterization by sharp indentation of metals and alloys are at issue.

Indeed, the method discussed above for determining general relations between global indentation variables and material properties is applicable for many other types of materials. Finite element (numerical) modeling of indentation problems is nowadays a fairly straightforward procedure and

with increasingly faster computers a large amount of problems can be solved in a relatively short time, also when the constitutive behaviour is quite complicated. Generally, it is not necessary to apply such features as explicit time-integration and/or remeshing procedures (save, perhaps, for some cases of thin film indentation analysis). In addition, almost every available commercial finite element program allow the implementation of a “self-constructed” constitutive behaviour which, as discussed previously, indicates that material modeling for indentation problems is more of a general research issue and not particularly an issue related to modeling of indentation problems. Despite of this though, indentation modeling of materials with a constitutive behaviour not accurately described by classical elastoplasticity is not very mature (the exception being of course elastic and viscoplastic materials for which classical analytical solutions by Sneddon [29] and Ting [30] have been further developed for pyramid indenters by for example Giannakopoulos et al. [21] and Larsson et al. [22] also including large deformation effects). Certainly, there exists a large amount of analyses for different kinds of materials, cf. e. g. Bower et al. [31] for power law creep, Storåkers et al. [32] for general viscoplasticity, Giannakopoulos and Larsson [33], Larsson and Giannakopoulos [34] and Narasimhan [35] for pressure-sensitivity, Fleck et al. [36] for porous materials and Reguero et al. [37] for crystal plasticity. However, these studies are nowhere near as detailed as the ones discussed above for classical elastoplasticity (or rests on the assumption of small strain theory to prevail) and can not be used when more general material characterization is at issue. **Having said this though, it is encouraging that in the case of strain gradient plasticity, a fairly involved material model, material science and solid mechanics modeling, including numerical modeling, have interacted in a very productive way resulting in good progress. In this context, previously discussed (and other similar) strain gradient material models, [8]-[11], have been implemented into finite element procedures and a lot of interesting results have been achieved for example concerning piling-up/sinking-in and the indenter tip radius effect. Representative work as regards this issue include Shu and Fleck [38], Begley and Hutchinson [39], Huang et al. [40], Xue et al. [41] and Qu et al. [42]. Furthermore, dislocation theory investigations, pertinent to sharp indentation, by for example Nix and Gao [43] and spherical indentation, by Swadener et al. [44], can be used to experimentally determine characteristic length scales in such nonlocal constitutive equations.**

So far the discussion has been restricted to issues related to the loading part of an indentation experiment but also when it comes to indentation modeling (and subsequently also for material characterization) of the unloading behaviour progress has been made in recent years. This is of course a direct result of the development during the 1980’s of instrumented devices for small scale indentation. The basic assumption when analysing the unloading part of an indentation test is, at least when material characterization is at issue, that initial unloading is well described as flat punch indentation of an elastic half-space (Boussinesq’s problem), cf. e. g. Loubet et al. [45]. Consequently, classical solutions, by for example Sneddon [46], could be used at initial unloading in order to determine the elastic stiffness of the material according to

$$\frac{E}{(1-\nu^2)} = \frac{\sqrt{\pi}}{2\sqrt{A}} \frac{dP}{dh} \quad (8)$$

where A is the contact area and dP/dh is the stiffness at initial unloading. The main problem when applying eq. (8) is to determine the contact area in a correct manner. Oliver and Pharr [6]

1
2
3
4
5 suggested in a now classical paper a fairly straight-forward procedure for this task and their
6 approach has been used extensively for both research and more applied purposes. However, it
7 should be pointed out that when piling-up of material around the indenter is more pronounced the
8 Oliver-Pharr procedure becomes less accurate, cf. e. g. Bolshakov and Pharr [47] and, accord-
9 ingly, there exist many suggestions of improvement of the Oliver-Pharr procedure. These sugges-
10 tions have been discussed in detail previously, Oliver and Pharr [17], and will not be dwelled upon
11 further here.
12
13

14
15 From the above discussion it is hopefully clear that indentation analysis of classical elastoplastic
16 materials nowadays is very well developed. Furthermore, there also exists powerful and (most
17 likely) sufficient analytical and numerical (and of course also experimental) tools to be used in
18 order to achieve the same level of knowledge for other types of materials. Having said this though,
19 it is also clear, at least in the authors opinion, that there still remains some fundamental issues that
20 must be further discussed in a, perhaps, more systematic manner. A detailed discussion about
21 these issues is the main objective of the present paper and this will be undertaken in the following
22 section.
23
24

25 26 27 **3. Fundamental issues at indentation modeling.** 28

29 In this section some fundamental issues at modeling of indentation experiments will be discussed
30 and hopefully clarified. It should be stated that there is no relation between the order of appear-
31 ance of each individual subject and it's importance for modeling. Having said this though it must
32 be pointed out that the question of whether or not large deformation theory should be applied at
33 indentation modeling is indeed of utmost importance for the accuracy of analytical and numerical
34 predictions.
35
36

37 **3.1 The influence from large deformations.** 38

39 Most if not all of the classical analytical contact (or indentation) solutions are based on the
40 assumption that small strain/deformation theory is sufficient for accurate predictions, cf. e. g.
41 Hertz [48] and Sneddon [46]. This is in many cases a very good assumptions and in particular so
42 for smooth indenters, such as the sphere, where, at least at initial and intermediate loading, large
43 strains are only found in small confined regions, cf. e. g. Biwa and Storåkers [49] and Storåkers et
44 al. [32]. However, at sharp indentations problems, at least for standard indenters with the angle β
45 (β is the angle between the indenter and the undeformed surface of the material) in Fig. 2 being
46 approximately 20° or larger, very large strains are present first of all close to the indenter tip and
47 secondly, they are present over the entire contact area as shown by Giannakopoulos et al. [21]. It
48 is therefore questionable whether or not small strain/deformation theory will provide results of
49 sufficient accuracy at sharp indentation analyses. However, this issue is of fundamental impor-
50 tance as also nowadays, many advanced analyses of sharp indentation are based on small defor-
51 mation theory, cf. e. g. Sakai et al. [50].
52
53
54
55
56

57 The possible effect from large deformations was recognized in early FEM analyses of cone inden-
58 tation by Bhattacharya and Nix [23], [24], using an hypoelastic-plastic version of Mises plasticity,
59
60

and Laursen and Simo [25], using an hyperelastic-plastic version of Mises plasticity. Indeed, from a numerical (FEM) point of view large deformation theory is actually to be preferred at indentation (contact) problems as convergence then is more rapid and more likely and the advantage of assuming small strain theory instead becomes obvious at more analytical (theoretical) studies. A detailed investigation of this feature has, to the authors knowledge, not been undertaken (or at least not published internationally) and it is not the intention to present such an investigation here either. Instead, scattered results from a number of different investigations will be studied leading to, hopefully, some straight-forward conclusions pertinent to this issue.

Giannakopoulos et al. [21] and Larsson et al. [22] presented FEM analyses of Vickers and Berkovich indentation of purely elastic as well as classical elastoplastic materials. Both small deformation and large deformation theory was used but only a very limited discussion about the similarities and discrepancies between the two sets of results were presented. Drawing upon the results from the two articles it was found that when it comes to purely elastic deformations global and local quantities given by small strain and large strain analyses are very similar both quantitatively and qualitatively. At least so when an hypoelastic formulation of Hooke's law is relied upon for the large strain results. For elastoplastic materials with strain-hardening the situation is somewhat different as then global properties (P - h -relation in this case) given by the two types of analyses starts to deviate. This is even more clear from presently performed FEM calculations, the commercial finite element package ABAQUS [51] was used, with results pertinent to cone indentation of an (hypo)elastic-perfectly plastic material, not investigated by Giannakopoulos et al. [21] and Larsson et al. [22], shown in Fig. 5. Obviously, the results given by large strain and small strain theory differs substantially. It should be emphasized here that the comparison shown in Fig. 5 is not strictly valid from a mechanical point of view as in both types of analyses the same uniaxial stress-strain curve with no hardening was used. A correct relationship between small strain and large strain field variables include the transformation (in nominal uniaxial compression)

$$\left. \begin{aligned} \sigma_{ls} &= \sigma_{ss}(1 - \varepsilon_{pss}) \\ \varepsilon_{pls} &= -\ln(1 - \varepsilon_{pss}) \end{aligned} \right\} \quad (9)$$

where ε_p is the accumulated plastic strain (effective strain in a multiaxial situation) and ls and ss denote large strain and small strain quantities respectively. If the relations in eq. (9) were accounted for the difference between the two sets of results in Fig. 5 would be smaller (but still substantial). However, the comparison shown in Fig. 5 is the most obvious from a practical engineering point of view and therefore seems the one most relevant for the present discussion. Indeed, similar results have been reported also for Brinell (spherical) indentation by Mesarovic and Fleck, [52], [53], where the results also indicate that large strain effects are more pronounced at no or low hardening materials.

Returning to the analyses by Giannakopoulos et al. [21] and Larsson et al. [22] these authors also conclude that for elastoplastic materials large strain effects are substantial when it comes to local field variables such as stresses and strains and in this case both quantitative and qualitative disagreement can be found. For example, Larsson et al. [22] conclude that the hydrostatic pressure at Berkovich indentation is completely compressive when a full large strain analysis is applied while

regions of tensile values appear in a small strain analysis. This result has indeed important implications as regards crack initiation at pyramid indentation.

As indicated above, large strain effects are small or negligible when elastic material behaviour is at issue. This has also been confirmed in comprehensive experimental analyses by Lim and Chaudri, [54], [55], pertinent to cone indentation of highly elastic polymers. For example, in [55] these authors compared their experimental results with the theoretically derived formula for elastic cone indentation by Sneddon [29] yielding

$$P = \frac{2Eh^2 \cot \beta}{\pi(1 - \nu^2)}. \quad (10)$$

In short, very good agreement between theory and experiments were found, see Fig. 6, indicating once again that large strain effects are small at elasticity.

To conclude then this subsection, large strain effects can be of importance at sharp indentation of elastoplastic materials (and most likely then also for other nonlinear materials) and must be accounted for when high accuracy is warranted. In particular, when it comes to local field variables substantial qualitative and quantitative differences are found between large strain and small strain results. At elastic material behaviour the two types of analyses give acceptably close results and there is no reason to believe that this does not apply for viscoelasticity as well.

3.2 Differences and similarities between cone and pyramid indentation results.

Eventhough advanced numerical methods and increasingly faster computers are available today solving truly three dimensional contact problems using FEM can be a rather time consuming task to undertake. Therefore, it is very common that when analysing three dimensional indentation problems (for example Vickers and Berkovich indentation) cone indentation is attacked instead as an axisymmetric (two-dimensional) approximation. However, the accuracy of such an approximative modeling has not been discussed in detail in the literature and this is what is attempted here in a small scale.

The first question as regards this feature concerns the equivalent angle of the conical indenter. Johnson [3] suggested that cone indentation with an angle β between the indenter and the undeformed surface of the material, see Fig. 2, being 19.7° would yield similar results as Vickers indentation based on the fact that such a cone would (at least nominally) displace the same amount of material as a Vickers indenter (and also a Berkovich indenter). This angle value has been used frequently in pertinent FEM analyses, cf. e. g. Bolshakov et al. [56]. Another angle value frequently used is 22° as this corresponds to the actual value between the indenter and the undeformed surface of the material at Vickers indentation, cf. e. g. Larsson [19]. In the authors opinion, the choice of angle value β is of little or no importance for at least the interpretation of the numerical results as long as β takes on a value in the region of 20° . As shown in Fig. 7, results taken from Atkins and Tabor [6] (experimental) and Larsson [57] (numerical), the hard-

ness is very weakly dependent on β in this region and furthermore, the difference in c^2 -values between for example $\beta = 19.7^\circ$ and $\beta = 22^\circ$ is not dramatic either, cf. results for an aluminium alloy 8009 as analysed by Bolshakov et al. [56] and Carlsson and Larsson [27]. Indeed, the difference between the c^2 -values can be well explained by the ratio $((\tan 22^\circ)/(\tan 19.7^\circ))^2$ corresponding to the size of the nominal contact areas for the two cone angles. It is also interesting to note that for this particular material cone indentation results pertinent to $\beta = 22^\circ$ are in better agreement with experimental Berkovich results than corresponding ones for $\beta = 19.7^\circ$, cf. Tsui et al. [58], Bolshakov et al. [56] and Carlsson and Larsson [27]. This is perhaps not expected as the angle $\beta = 19.7^\circ$ was chosen with precisely correspondence to Vickers (and Berkovich) indentation in mind.

More material related to the above discussion can be found in Larsson [19] where a fairly comprehensive FEM investigation of sharp indentation of elastoplastic materials were presented. Here it was found that hardness values at cone indentation ($\beta = 22^\circ$) of rigid-plastic materials, with standard power-law strain hardening according to

$$\sigma = \sigma_0 \varepsilon_p^{1/m}, \quad (11)$$

are close to Vickers results with the largest difference for perfectly plastic materials (approximately 10%). The same result was found for the area ratio c^2 as shown in Fig. 8. Again the largest difference was found for perfectly plastic materials (approximately 10%). It should be remembered though that piling-up (or sinking-in) of material is not constant along the contact boundary at pyramid indentation and the good agreement between the two sets of results reported in Fig. 8 is pertinent to the definition of c^2 in eq. (7) (at pyramid indentation this can be considered as an average measure of piling-up or sinking-in).

Above only global cone and Berkovich indentation results have been compared. It is, however, obvious that the details concerning the behaviour of local field variables at pyramid indentation can not be well captured by an approximative cone model. Basically, pyramid indentation is a truly three dimensional problem while axisymmetry prevails at cone indentation. This can also be concluded from the Vickers and Berkovich indentation analyses by Giannakopoulos et al. [21] and Larsson et al. [22] showing that stress and strain fields in these types of problems are nowhere near axisymmetry, not even at some distance from the contact region. This is, indeed, of great importance when crack propagation and growth at pyramid indentation are to be analysed.

Accordingly, it can be concluded that cone indentation approximations of pyramid indentation give in most cases both qualitatively and quantitatively good results for global indentation variables. As could be expected though, the situation is much worse for local field variables such as stresses and strains.

3.3 *The influence from residual stresses at indentation.*

1
2
3
4
5 In the past, several investigations dealing with the influence from in-plane residual stresses on the
6 results given by a sharp indentation test have been presented, cf. e. g. Lafontaine et al. [59]. The
7 basic features of the problem were not fully understood, however, until Tsui et al. [58] and
8 Bolshakov et al. [56] investigated, by using nano-indentation as well as numerical methods, the
9 influence of applied stress on hardness, contact area and apparent elastic modulus at indentation
10 of aluminum alloy 8009. Qualitative results of substantial interest were presented as it was shown
11 that the hardness was not significantly affected by applied (residual) stresses while the amount of
12 piling-up of material at the contact contour proved to be sensitive to stress (piling-up increased
13 when the applied stresses were compressive and decreased at tensile stresses), see Fig. 9. With
14 these results as a basis Suresh and Giannakopoulos [60] derived, by making certain assumptions
15 on the local stress and deformation fields in the contact region, a relation between the contact area
16 at indentation of a material with elastic residual stresses (and plastic residual strains) and the cor-
17 responding contact area at indentation of a material with no stresses present. The analysis by
18 Suresh and Giannakopoulos [60] was restricted to equi-biaxial residual stress and strain fields.

19
20
21
22
23 Further progress as regards modeling was achieved by Carlsson and Larsson, [26] and [27], in two
24 combined theoretical, numerical and experimental investigations. Basically, eventhough the theo-
25 retical approach was different, the results by Suresh and Giannakopoulos [60] were confirmed by
26 these authors. In short, it was shown that when an homogeneous equi-biaxial residual (or applied)
27 stress σ_{res} is present in a material the variation of the area ratio c^2 (as function of σ_{res}) is accu-
28 rately given by the relation

$$c^2 = c^2(\sigma_{res} = 0) - 0.32 \ln\left(1 + \frac{\sigma_{res}}{\sigma_y}\right) \quad (12)$$

29
30
31
32
33 where $c^2(\sigma_{res} = 0)$ is the area ratio for the stress-free material and otherwise in hopefully obvious
34 notation. The basis for eq. (12) is first of all the finding by Tsui et al. [58] and Bolshakov et al.
35 [56] that residual stresses only influences c^2 (and not the hardness) and secondly the previously
36 discussed feature that elastic effects are much more pronounced for c^2 than for the hardness.

37
38
39
40
41
42 Accordingly, the influence from residual stress on c^2 can be correlated with a Johnson-curve
43 according to Fig. 3 leading to eq. (12). Furthermore, Carlsson and Larsson [27] also suggested an
44 approximative method for extending the validity of eq. (12) to more general residual stress fields
45 but these relations do not admit a short discussion and will not be dwelled upon further here.

46
47
48
49
50
51
52
53
54
55
56
57
58
59
60
Unfortunately, it was found from the experimental results presented in Carlsson and Larsson [27]
that acceptable accuracy of results (based on the above discussed theoretical foundation) was hard
to achieve as c^2 is not strongly dependent on residual stresses in case of sharp indentation using
standard indenter geometries, cf. eq. (12), unless the residual stresses are very close to the mate-
rial yield stress. This is of course in particular so when determination of nonhomogeneous
stresses is at issue. A remedy to this problem was suggested by Larsson [57] who discovered that
the sensitivity of c^2 to residual stresses could be increased by using indenters with small (the

1
2
3
4
5 smaller the better) values on the angle β . However, for mainly two reasons this finding does not
6 significantly enhance the usefulness of sharp indentation testing when it comes to determination
7 of residual stresses. First of all, the “sensitivity increase” of c^2 at smaller angle values of β is not
8 sufficiently large for allowing high accuracy predictions and secondly, a smaller value on the β -
9 angle leads to increasing difficulties when it comes to determining correct values on the actual
10 contact area A , a feature that almost eliminates the advantage of higher sensitivity to residual
11 stresses achieved by reducing β (naturally though, the qualitative prediction capability is
12 improved). Accordingly, it can be concluded that at least quantitative determination of residual
13 stresses by using sharp indentation is a very difficult task to undertake.
14
15
16
17

18
19 Another approach to the problem of determining residual stresses using indentation was sug-
20 gested by Swadener et al. [61]. These authors found that in case of spherical indentation, indenta-
21 tion properties are significantly more sensitive (than at sharp indentation) to stress in the elastic-
22 plastic deformation regime (level II as defined above). Indeed, at spherical indentation in level II
23 the hardness, see Fig. 10, and of course also the area ratio, is strongly dependent of a residual (or
24 applied) stress field. This important finding was utilized in order to develop two methods for
25 determining residual stresses from load and depth sensing indentation experiments. These meth-
26 ods showed very promising results for the case of determination of equi-biaxial stress states, both
27 qualitatively and quantitatively. In this context it should be noted in passing that at spherical
28 indentation of elastoplastic materials the radius of the sphere constitutes a representative length
29 and, accordingly, the hardness will be a function of load (or indentation depth) in such an experi-
30 ment. Consequently, during a spherical indentation test all three indentation levels as shown in
31 Fig. 1 are represented, in contrast to the situation at sharp indentation, and information pertinent
32 to the findings by Swadener et al. [61] can then always be extracted from such a test.
33
34
35

36
37 Summing up the discussion above then, it can be concluded from the results presented in the liter-
38 ature that high accuracy quantitative predictions about residual stress using sharp indentation is
39 hard to achieve (in particular when the stress fields are nonhomogeneous), at least so based on the
40 progress achieved by the scientific community so far. When qualitative predictions as regards for
41 example the sign of the stress components is at issue sharp indentation might be a useful tool due
42 to it’s simplicity but otherwise spherical indentation constitutes a much better alternative. Having
43 said this though, it should be pointed out that sharp indentation can still be a valuable tool in this
44 context and especially then when the in-plane stresses are no longer equi-biaxial. It has been
45 pointed out by Kwon [62] that for such a situation the low-symmetry Knoop indenter can be used
46 to determine the ratio between in-plane residual principal stresses. It remains, however, to verify
47 this interesting suggestion by experimental and numerical investigations.
48
49
50

51 *3.4 The effective elastic modulus at indentation*

52

53
54 In Hertz [48] classical contact theory it is assumed that elastic and frictionless contact between
55 two bodies, characterized by radii of curvature R_1 and R_2 , prevails at small strain conditions.
56 One of the results given by the analysis by Hertz [48] is that the influence from the material con-
57 stants of the two bodies can be summarized by using an effective elastic modulus (or more cor-
58 rectly, an effective elastic stiffness) reading
59
60

$$\frac{1}{E_{eff}} = \frac{(1 - \nu_1^2)}{E_1} + \frac{(1 - \nu_2^2)}{E_2} \quad (13)$$

in hopefully obvious notation. Remembering that one of the assumptions in this contact theory is that each of the contacting bodies can be described by a radius of curvature there is no theoretical foundation whatsoever for using eq. (13) in order to describe the deformation of the indenter at sharp indentation problems. Despite of this though this is, indeed, a very common method used when analysing nanoindentation problems and in particular then when the previously discussed Oliver-Pharr-procedure for determining the elastic stiffness is applied.

The accuracy involved when using eq. (13) also at sharp indentation problems has been discussed and experimentally analysed by Chaudhri [63] and Lim and Chaudhri [54]. In particular in Lim and Chaudhri [54] a comprehensive experimental study dealing with this issue was performed. Basically, in the experiments a highly elastic rubber cone was indenting highly elastic polymeric materials (and also other types of materials) and the P - h -relation was recorded. If the indenter was rigid the Sneddon [29] analysis yielding eq. (10) would apply. A proper way to investigate the assumption of an elastic stiffness according to eq. (13) is, as was also done by Lim and Chaudhri [54], of course then to compare the experimental results with an equation

$$P = \frac{2E_{eff}h^2 \cot\beta}{\pi}. \quad (14)$$

Representative results from the experimental investigation is shown in Fig. 11. Note that as both indenter and indented material is deforming the mutual approach h_d is used instead of the indentation depth. It is clear that the accuracy of predictions based on Eq. (14) is not good and consequently, the deformation of the indenter is in this case not very well represented by the approximative expression in eq. (13). It should be pointed out in this context that at indentation with a truly rigid indenter Lim and Chaudhri [55] found very good agreement with Sneddon's [29] original equation.

Based on the discussion above it can be concluded that eq. (13) is not a very reliable tool to be used when accounting for indenter deformation at sharp indentation. It goes without saying that the main objection towards eq. (13) concerns the fact that it has no theoretical justification whatsoever. There may very well be situations where this approximation works well but there is no analytical way to determine when this is so and it seems appropriate to suggest here that sufficient experimental efforts are devoted towards a better understanding of this issue and before this is undertaken, a warning sign is flashed when it comes to using eq. (13) when analysing and modeling sharp indentation problems.

3.5 Differences and similarities between indentation and scratch testing. The existence of a representative strain at scratch testing.

Standard indentation testing and scratch testing obviously have many features in common but it is

also clear that there are many differences between the two methods. Indentation methods have been used primarily (but of course not exclusively) for constitutive characterization of materials while scratching often is used for determining wear resistance and material properties related to fracture mechanics. As in the case of indentation the scratch test has been used extensively in order to investigate different materials, mainly metals and polymers but also such materials as ceramics, glass and carbon/carbon composites, cf. e. g. Ichimura and Rodrigo [64], Li et al. [65] and Jouannigot et al. [66].

From a modeling point of view scratching is a much tougher problem than the indentation problem. The strain levels involved are very high and during a finite element analysis large distortion of elements can not be avoided. As a result, remeshing procedures are unavoidable and most often also explicit time-integration have to be applied. Consequently, a numerical analysis of the scratch test is significantly more time-consuming than a corresponding indentation analysis and for this reason, it is clear that much can be gained if the knowledge achieved during many years of indentation modeling can be applied also when modeling scratching. This is not an obvious feature though as the two tests are similar but definitely not identical and comprehensive mechanical investigations are needed in order to clarify this matter.

As mentioned above numerical analyses of scratching is very time-consuming and very few such investigations have been reported in the literature (at least when compared to the large number of numerical investigations of indentation). Recently, however, better numerical tools and faster computers have made such numerical (FEM) studies possible. When it comes to the question of differences and similarities between scratching and indentation there are some pertinent investigations that have been reported, cf. e. g. Bucaille et al., [67] and [68], and Wredenberg and Larsson [69], and it is the intention here to discuss based on these studies the very important issues of correlation of scratch experiments and the possible existence of a representative strain level also at scratching.

Wredenberg and Larsson [69] studied cone scratching of classical elastoplastic materials with isotropic power-law strain hardening according to

$$\sigma(\varepsilon_p) = \sigma_y + \sigma_0 \varepsilon_p^{1/m} \quad (15)$$

in hopefully obvious notation. The material parameters used in the analysis were pertinent to metals and alloys, i. e. level III in Fig. 1, but for completeness, additional calculations were performed with material parameters leading to smaller values on Γ_h in eq. (2). The objective of this study was to, first of all, determine if the Johnson parameter Γ_h in eq. (2) can be used to also correlate scratch testing and secondly, investigate if the Tabor relation in eq. (4) is valid also at scratching, i. e. does a representative stress (or strain) exist also at scratching. The outcome of this investigation can be well summarized in Fig. 12 where hardness normalized by a representative stress σ_r is depicted as function of Γ_h . Obviously, the curves resembles the corresponding ones from indentation testing and it can be concluded with good accuracy that the Johnson parameter is an appropriate choice for correlation also when scratch testing is at issue (the exception being for linear strain

1
2
3
4
5 hardening behaviour but this case is erratic also in indentation analysis). Furthermore, the repre-
6 sentative strain level found (leading to the good correlation reported in Fig. 12) was $\epsilon_p \approx 0.57$
7
8 which clearly indicates that scratch testing is not a good tool for determining the uniaxial strain-
9 hardening behaviour of a material. Wredenberg and Larsson [69] also considered the effect of
10 friction, which is much more pronounced at scratch testing, and found that this feature gave quan-
11 titative but not qualitative effects on the curves in Fig. 12. The results by Wredenberg and Larsson
12 [69] are confirmed by previous studies by Bucaille et al. [67], perfectly-plastic materials, and by
13 Bucaille et al. [68], polymeric materials. Indeed, for polymers Bucaille et al. [68] reports a repre-
14 sentative strain level $\epsilon_p \approx 1.24$.
15
16

17
18 Accordingly, **there are clear indications** that the basic features when it comes to correlating inden-
19 tation testing holds true also in case of scratching. **It is, however, also clear that further research is**
20 **needed as regards this issue. In addition, it should be stated that** the high strain levels involved
21 during the scratch test makes it much less appropriate for standard material characterization.
22
23

24 25 **4. Final remarks.**

26
27 The aim of this paper was first of all to present an overview of the state of the art of modeling of
28 sharp indentation experiments. In particular indentation of classical Mises elastoplastic behaviour
29 was discussed but also modeling of indentation of other types of materials was touched upon. In
30 addition, some fundamental issues of substantial importance at indentation modeling was dis-
31 cussed in some detail. These issues were 1) the influence from large deformations, 2) differences
32 and similarities between cone and pyramid indentation results, 3) the influence from residual
33 stresses, 4) the effective elastic modulus at indentation and 5) differences and similarities between
34 indentation and scratch results. It was not the authors intention to present any complete and final
35 solution to the above issues but, instead, to draw the indentation communities attention to the fact
36 that a lot of interesting results are available and ready to use when it comes to these issues.
37
38
39
40

41 42 **References.**

- 43
44 [1] J.B. Pethica, R. Hutchings and W.C. Oliver, Philosophical Magazine, **A48**, 593 (1983).
45
46 [2] D. Tabor, Hardness of metals, Oxford University Press (1951).
47
48 [3] K. L. Johnson, Journal of the Mechanics and Physics of Solids, **18**, 115 (1970).
49
50 [4] K. L. Johnson, Contact mechanics, Cambridge University Press (1985).
51
52 [5] M. F. Doerner and W. D. Nix, Journal of Materials Research, **1**, 601 (1986).
53
54 [6] W. C. Oliver and G. M. Pharr, Journal of Materials Research, **7**, 1564 (1992).
55
56 [7] A. G. Atkins and D. Tabor, Journal of the Mechanics and Physics of Solids, **13**, 149 (1965).
57
58
59
60

- 1
2
3
4
5
6
7 [8] N. A. Fleck and J. W. Hutchinson, *Journal of the Mechanics and Physics of Solids*, **41**, 1825
8 (1993).
- 9
10 [9] H. Gao, Y. Huang, W. D. Nix and J. W. Hutchinson, *Journal of the Mechanics and Physics of*
11 *Solids*, **47**, 1239 (1999).
- 12
13 [10] Y. Huang, H. Gao, W. D. Nix and J. W. Hutchinson, *Journal of the Mechanics and Physics of*
14 *Solids*, **48**, 99 (2000).
- 15
16
17 [11] Y. Huang, S. Qu, K. C. Hwang, M. Li and H. Gao, *International Journal of Plasticity*, **20**, 753
18 (2004).
- 19
20
21 [12] V. B. Shenoy, R. Miller, E. B. Tadmor, D. Rodney, R. Phillips and M. Ortiz, *Journal of the*
22 *Mechanics and Physics of Solids*, **47**, 611 (1999).
- 23
24 [13] R. F. Cook and G. M. Pharr, *Journal of the American Ceramic Society*, **73**, 787 (1990).
- 25
26
27 [14] J. Lopez, *Polymer Testing*, **12**, 437 (1993).
- 28
29 [15] E. Söderlund and D. J. Rowcliffe, in *Analysis of Depth-Sensing Indentation*, PhD thesis by E.
30 Söderlund (Department of Materials Science and Engineering, KTH, Stockholm, Sweden, 1995).
- 31
32 [16] B. R. Lawn, *Journal of the American Ceramic Society*, **81**, 1977 (1998).
- 33
34 [17] W. C. Oliver and G. M. Pharr, *Journal of Materials Research*, **19**, 3 (2004).
- 35
36 [18] Y.-T. Cheng and C.-M. Cheng, *Materials Research and Engineering*, **R44**, 91 (2004).
- 37
38 [19] P.-L. Larsson, *International Journal of Mechanical Sciences*, **43**, 895 (2001).
- 39
40 [20] M. Dao, N. Chollacoop, K. J. Van Vliet, T. A. Venkatesh and S. Suresh, *Acta Materialia*, **49**,
41 3899 (2001).
- 42
43 [21] A. E. Giannakopoulos, P.-L. Larsson and R. Vestergaard, *International Journal of Solids and*
44 *Structures*, **31**, 2679 (1994).
- 45
46 [22] P.-L. Larsson, E. Söderlund, A. E. Giannakopoulos, D. J. Rowcliffe and R. Vestergaard,
47 *International Journal of Solids and Structures*, **33**, 221 (1996).
- 48
49 [23] A. K. Bhattacharya and W. D. Nix, *International Journal of Solids and Structures*, **24**, 881
50 (1988).
- 51
52 [24] A. K. Bhattacharya and W. D. Nix, *International Journal of Solids and Structures*, **24**, 1287
53 (1988).
- 54
55
56
57
58
59
60

- 1
2
3
4
5 [25] T. A. Laursen and J. C. Simo, *Journal of Materials Research*, **7**, 618 (1992).
6
7
8 [26] S. Carlsson and P.-L. Larsson, *Acta Materialia*, **49**, 2179 (2001).
9
10 [27] S. Carlsson and P.-L. Larsson, *Acta Materialia*, **49**, 2193 (2001).
11
12 [28] M. Mata, Continuum analysis of sharp indentation experiments in metallic materials: theory
13 and finite element simulations. PhD thesis, Universitat Politecnica de Catalunya (2004).
14
15 [29] I. N. Sneddon, *International Journal of Engineering Science*, **3**, 47 (1965).
16
17 [30] T. C. T. Ting, *Journal of Applied Mechanics*, **33**, 845 (1966).
18
19 [31] A. F. Bower, N. A. Fleck, A. Needleman and N. Ogbonna, *Proceeding of the Royal Society*
20 *of London*, **A441**, 97 (1993).
21
22 [32] B. Storåkers, S. Biwa and P.-L. Larsson, *International Journal of Solids and Structures*, **34**,
23 3061 (1997).
24
25 [33] A. E. Giannakopoulos and P.-L. Larsson, *Mechanics of Materials*, **25**, 1 (1997).
26
27 [34] P.-L. Larsson and A. E. Giannakopoulos, *Materials Research and Engineering*, **A254**, 268
28 (1998).
29
30 [35] R. Narasimhan, *Mechanics of Materials*, **36**, 633 (2004).
31
32 [36] N. A. Fleck, H. Otoyoy and A. Needleman, *International Journal of Solids and Structures*, **29**,
33 1613 (1992).
34
35 [37] R. A. Regueiro, D. J. Bammann, E. B. Marin and K. Garikipati, *Journal of Engineering*
36 *Materials and Technology*, **124**, 380 (2002).
37
38 [38] J. Y. Shu and N. A. Fleck, *International Journal of Solids and Structures*, **35**, 1363 (1998)
39
40 [39] M. R. Begley and J. W. Hutchinson, *Journal of the Mechanics and Physics of Solids*, **46**,
41 2049 (1998).
42
43 [40] Y. Huang, Z. Xue, H. Gao, W. D. Nix and Z. C. Xia, *Journal of Materials Research*, **15**, 1786
44 (2000).
45
46 [41] Z. Xue, Y. Huang, , K. C. Hwang and M. Li, *Journal of Engineering Materials and Technol-*
47 *ogy*, **124**, 371 (2002).
48
49 [42] S. Qu, Y. Huang, W. D. Nix, H. Jiang, F. Zhang and K. C. Hwang, *Journal of Materials*
50 *Research*, **19**, 3423 (2004).
51
52
53
54
55
56
57
58
59
60

- 1
2
3
4
5 [43] W. D. Nix and H. Gao, *Journal of the Mechanics and Physics of Solids*, **46**, 411 (1998).
6
7
8 [44] J. G. Swadener, E. P. George and G. M. Pharr, *Journal of the Mechanics and Physics of Sol-*
9 *ids*, **50**, 681 (2002).
10
11 [45] J. L. Loubet, J. M. Georges, O. Marchesini and G. Meille, *Journal of Tribology*, **106**, 43
12 (1984).
13
14
15 [46] I. N. Sneddon, *Proceedings of the Cambridge Philosophical Society*, **42**, 29 (1945).
16
17 [47] A. Bolshakov and G. M. Pharr, *Journal of Materials Research*, **13**, 1049 (1998).
18
19
20 [48] H. Hertz, *Journale der Reine angewandte Mathematik*, **92**, 156 (1882).
21
22 [49] S. Biwa and B. Storåkers, *Journal of the Mechanics and Physics of Solids*, **43**, 1303 (1995).
23
24 [50] M. Sakai, M. Sasaki and A. Matsuda, *Acta Materialia*, **53**, 4455 (2005).
25
26
27 [51] ABAQUS, Users manual, version 6.3, Hibbit, Karlsson and Sorensen (2002).
28
29 [52] S. D. Mesarovic and N. A. Fleck, *Proceeding of the Royal Society of London*, **A455**, 2707
30 (1999).
31
32 [53] S. D. Mesarovic and N. A. Fleck, *International Journal of Solids and Structures*, **37**, 7071
33 (2000).
34
35
36 [54] Y. Y. Lim and M. M. Chaudhri, *Philosophical Magazine*, **83**, 3427 (2003).
37
38 [55] Y. Y. Lim and M. M. Chaudhri, *Journal of Applied Physics*, **98**, 073518-1 (2005).
39
40
41 [56] A. Bolshakov, W. C. Oliver and G. M. Pharr, *Journal of Materials Research*, **11**, 760 (1996).
42
43 [57] P.-L. Larsson, Report 378, Department of Solid Mechanics, KTH, Stockholm, Sweden, 2004.
44 Submitted to *Journal of Materials Processing Technology*.
45
46
47 [58] T. Y. Tsui, W. C. Oliver and G. M. Pharr, *Journal of Materials Research*, **11**, 752 (1996).
48
49 [59] W. R. Lafontaine, B. Yost and C.-Y. Li, *Journal of Materials Research*, **5**, 776 (1990).
50
51
52 [60] S. Suresh and A. E. Giannakopoulos, *Acta Materialia*, **46**, 5755 (1998).
53
54 [61] J. G. Swadener, B. Taljat and G. M. Pharr, *Journal of Materials Research*, **16**, 2091 (2001).
55
56 [62] D. Kwon, private discussion, 2005.
57
58
59 [63] M. M. Chaudhri, *Journal of Materials Research*, **16**, 336 (2001).
60

1
2
3
4
5
6 [64] H. Ichimura and A. Rodrigo, *Surface & Coatings Technology*, **126**, 152 (2000).
7

8 [65] K. Li, Y. Shapiro and J. C. M. Li, *Acta Materialia*, **46**, 5569 (1998).
9

10 [66] S. Jouannigot, J. Lamon and J. L. Loubet, *Key Engineering Materials*, **264-268**, 2271 (2004).
11

12 [67] J. L. Bucaille, E. Felder and G. Hochstetter, *Wear*, **249**, 422 (2001).
13

14 [68] J. L. Bucaille, E. Felder and G. Hochstetter, *Journal of Tribology*, **126**, 372 (2004).
15

16 [69] F. Wredenber and P.-L. Larsson, in *Computer Methods and Experimental Measurements for*
17 *Surface Effects and Contact Mechanics VII*, edited by J. T. M. de Hosson, C. A. Brebbia and S.-I.
18 Nishida (WIT Press, Southampton, 2005).
19
20
21
22
23
24
25
26
27
28
29
30
31
32
33
34
35
36
37
38
39
40
41
42
43
44
45
46
47
48
49
50
51
52
53
54
55
56
57
58
59
60

1
2
3
4
5 **Figure legends.**
6

7
8 1. Normalized hardness, $\bar{H} = H/\sigma_p$, as a function of $\ln\Gamma$, Γ defined according to eq. (1). Schematic of the correlation of sharp indentation testing of elastic-perfectly plastic materials as originally suggested by Johnson [3]. The three levels I, II, and III, pertinent to different indentation response, are also indicated in the figure.
9
10
11
12

13
14 2. Schematic of the geometry of the indentation tests. (a) Cone indentation. (b) Vickers indentation.
15
16

17
18 3. (a) Normalized hardness, $\bar{H} = H/\sigma_p$, and area ratio, c^2 , as functions of $\ln\Gamma$, Γ defined according to eq. (1). Schematic of the correlation of sharp indentation testing of elastic-perfectly plastic materials. The three levels I, II, and III, pertinent to different indentation response, are also indicated in the figure. (b) Detailed description of the behaviour of the area ratio, c^2 , as function of $\ln\Gamma$, Γ defined according to eq. (1), at cone indentation of elastic-perfectly plastic materials. (○) FEM results by Larsson [19] and Carlsson and Larsson [26].
19
20
21
22
23
24
25
26

27
28 4. Uniaxial stress-strain curves for SAF2507 superduplex stainless steel. (○) Uniaxial test results by Mata [28]. (—) Results derived from indentation tests using the methodology proposed by Mata [28].
29
30
31
32

33 5. Normalized indentation load, $P/P_{max_{ss}}$, as function of normalized indentation depth, h/h_{max} , for an (hypo)elastic-perfectly plastic material with the explicit material constants $E = 70$ GPa, $\nu = 0.3$, $\sigma_y = 400$ MPa. $P_{max_{ss}}$ is the maximum indentation load from the large strain solution. Present FEM-results for small strain and large strain formulation.
34
35
36
37
38
39

40 6. Indentation load, P , as function of indentation depth, h , at indentation of rigid cones ($\beta = 43^\circ$) on PDMS polymers. Explicit elastic material constants are given in Lim and Chaudhri [55]. (—) Predictions from eq. (10). (○) Selection of representative experimental results by Lim and Chaudhri [55].
41
42
43
44
45

46 7. The constant C , in eq. (4), as function of cone angle β , defined in Fig. 2, at cone indentation of an elastic-perfectly plastic material. (—) Experimental results by Atkins and Tabor [7]. (- - -) FEM results by Larsson [57].
47
48
49
50

51 8. Indentation invariant, c^2 , as function of $1/m$ at indentation of a rigid plastic power law material according to eq. (11). (O, - - -), FEM results by Larsson [19], and a fit to the results, for cone indentation. (□, - · -), FEM results by Larsson [19], and a fit to the results, for Vickers indentation.
52
53
54
55
56
57
58
59
60

1
2
3
4
5
6 **9.** Indentation invariant, c^2 , as function of applied (residual) in-plane equi-biaxial stress at cone
7 indentation of aluminium alloy 8009. Explicit material constants are given in Bolshakov et al.

8
9 [56]. (O), FEM results by Bolshakov et al. [56]. (- - -) Line indicating the c^2 -value for the stress-
10 free material.
11

12
13 **10.** Normalized hardness, $\bar{H} = H/\sigma_y$, as a function of the parameter $\ln(Ea/((1 - \nu^2)\sigma_y R))$ at
14 spherical indentation of an elastoplastic material with or without an residual (applied) in-plane
15 equi-biaxial stress field σ_{res} present in the material. Above, a is the contact radius during indenta-
16 tion and R is the radius of the spherical indenter. Fit to FEM results by Swadener et al. [61].
17
18

19
20 **11.** Indentation load, P , as function of mutual approach, h_d , at indentation of rubber cones
21 ($\beta = 30^\circ$) on PDMS polymers. Explicit elastic material constants are given in Lim and Chaudhri
22 [54]. (—) Experimental results by Lim and Chaudhri [54]. (- - -) Predictions from eq. (14).
23
24

25
26 **12.** Normalized scratch (normal) hardness, $\bar{H} = H/\sigma_r$, as a function of $\ln\Gamma_h$, Γ_h defined
27 according to eq. (2), at cone scratching of an elastoplastic material with strain-hardening accord-
28 ing to eq. (15). FEM results by Wredenberg and Larsson [69].
29
30
31
32
33
34
35
36
37
38
39
40
41
42
43
44
45
46
47
48
49
50
51
52
53
54
55
56
57
58
59
60

1
2
3
4
5
6
7
8
9
10
11
12
13
14
15
16
17
18
19
20
21
22
23
24
25
26
27
28
29
30
31
32
33
34
35
36
37
38
39
40
41
42
43
44
45
46
47
48
49
50
51
52
53
54
55
56
57
58
59
60

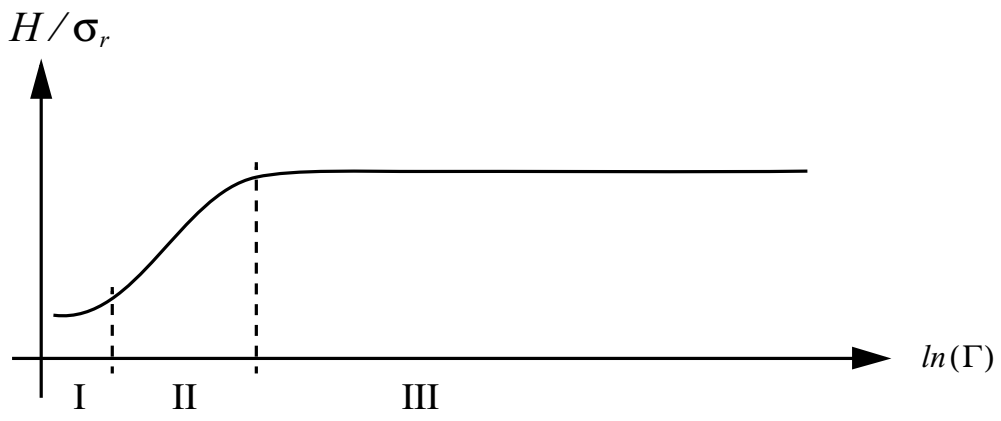

Figure 1

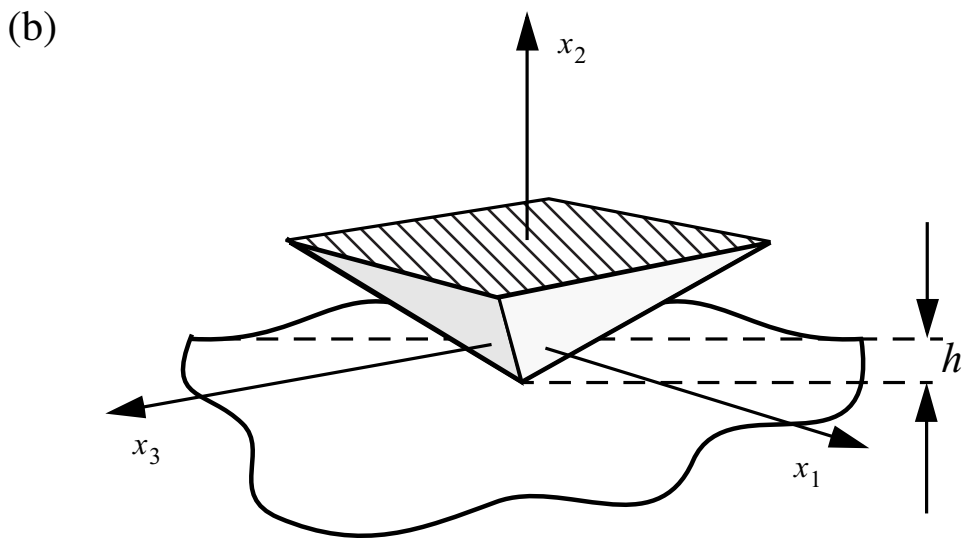
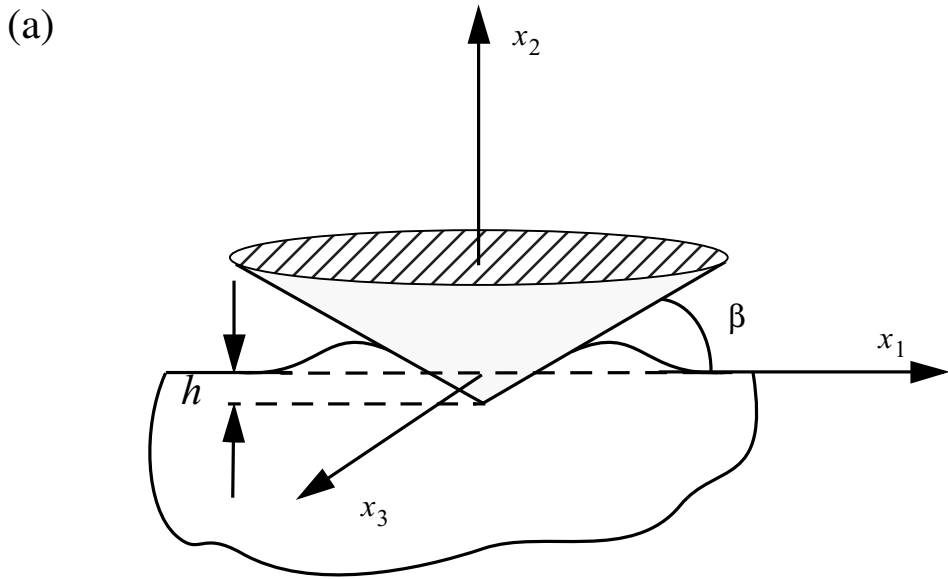

Figure 2

1
2
3
4
5
6
7
8
9
10
11
12
13
14
15
16
17
18
19
20
21
22
23
24
25
26
27
28
29
30
31
32
33
34
35
36
37
38
39
40
41
42
43
44
45
46
47
48
49
50
51
52
53
54
55
56
57
58
59
60

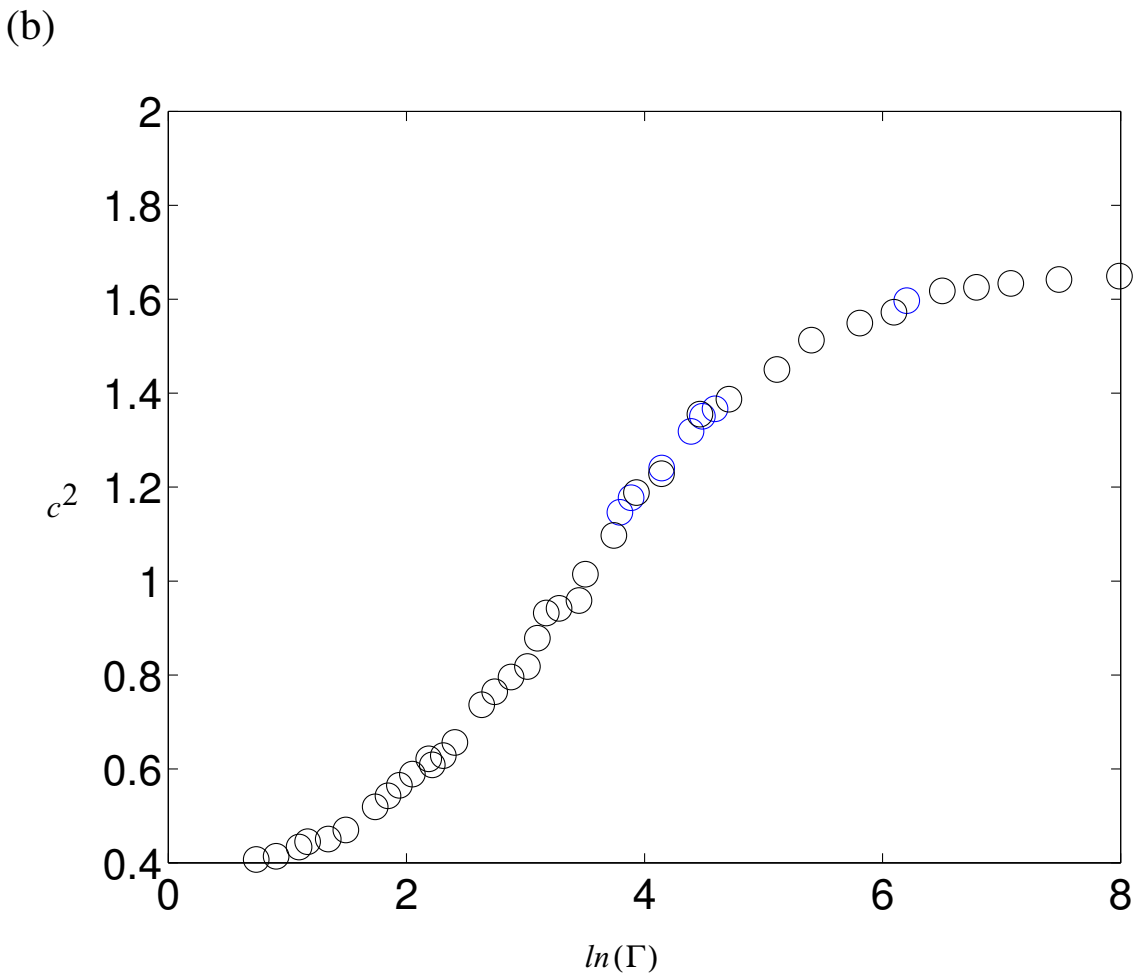
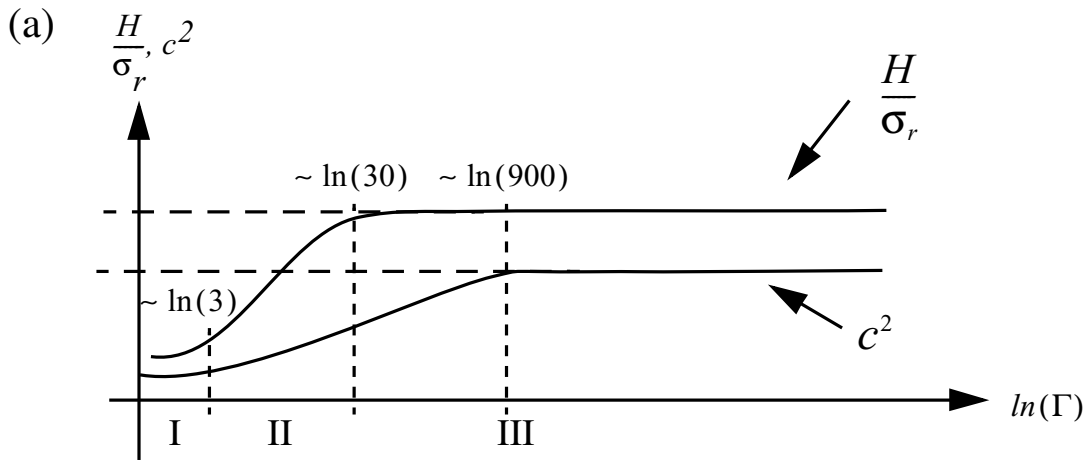
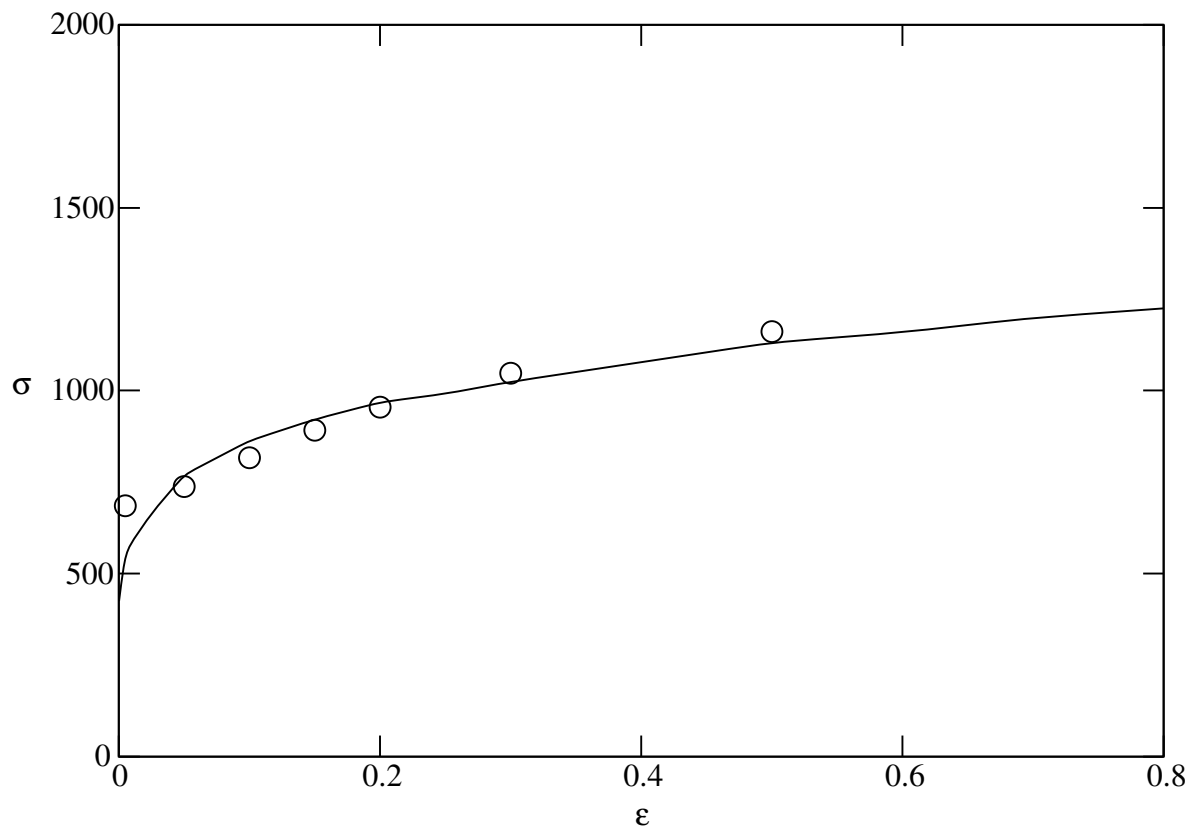

Figure 3

**Figure 4**

1
2
3
4
5
6
7
8
9
10
11
12
13
14
15
16
17
18
19
20
21
22
23
24
25
26
27
28
29
30
31
32
33
34
35
36
37
38
39
40
41
42
43
44
45
46
47
48
49
50
51
52
53
54
55
56
57
58
59
60

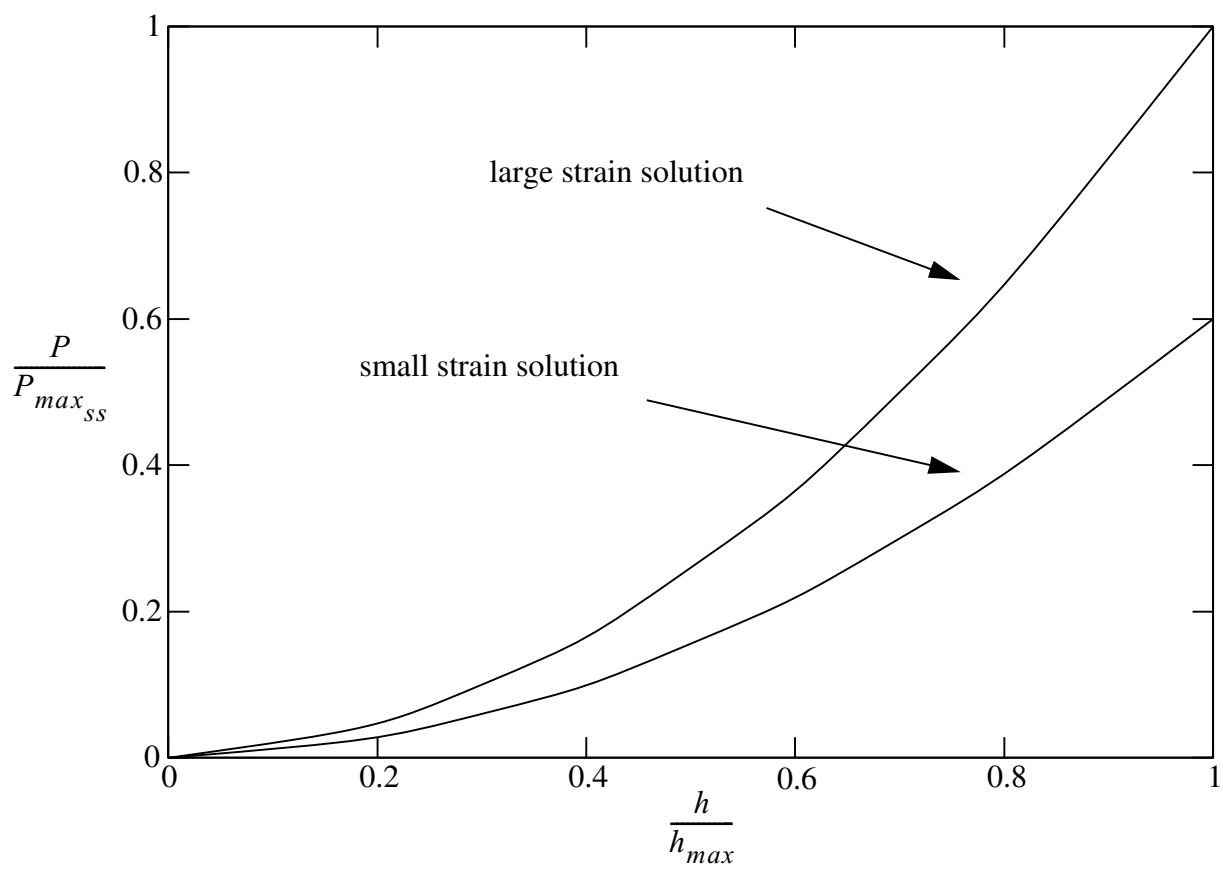
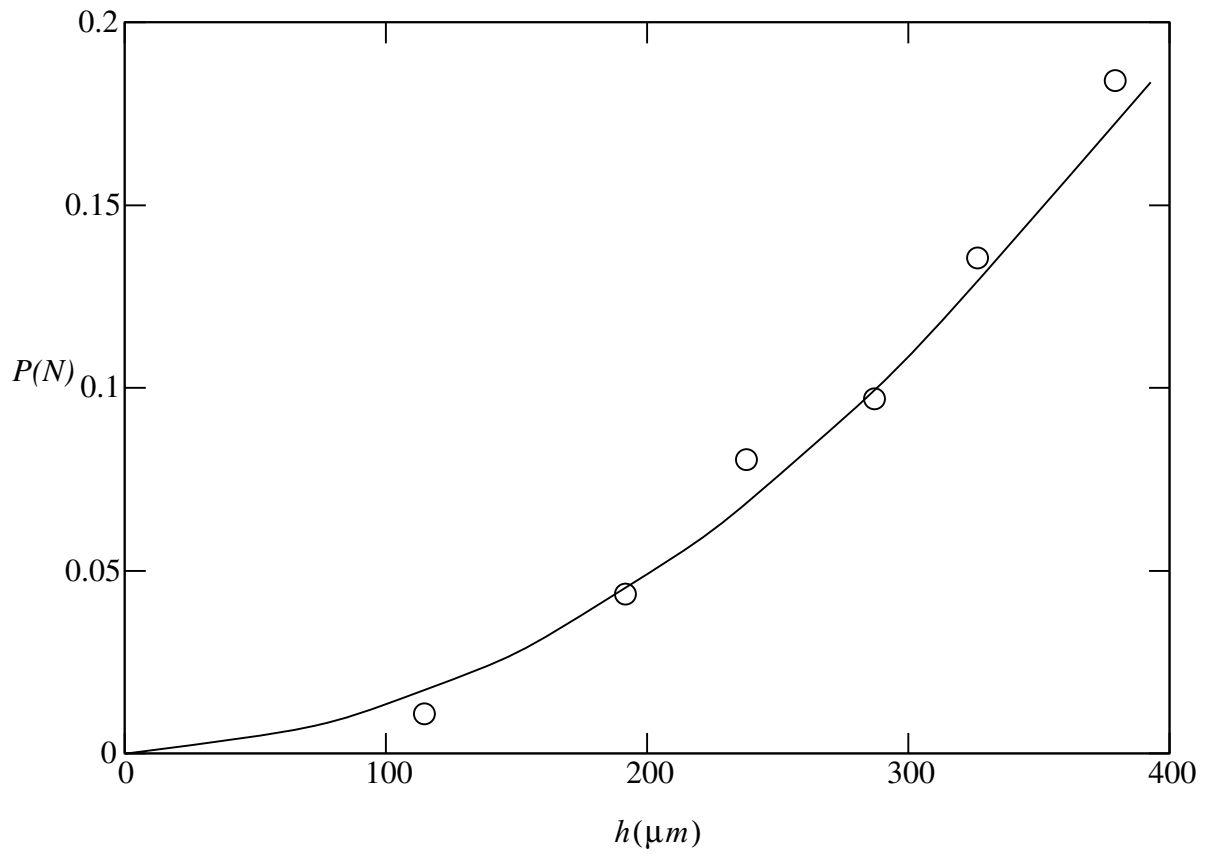

Figure 5

**Figure 6**

1
2
3
4
5
6
7
8
9
10
11
12
13
14
15
16
17
18
19
20
21
22
23
24
25
26
27
28
29
30
31
32
33
34
35
36
37
38
39
40
41
42
43
44
45
46
47
48
49
50
51
52
53
54
55
56
57
58
59
60

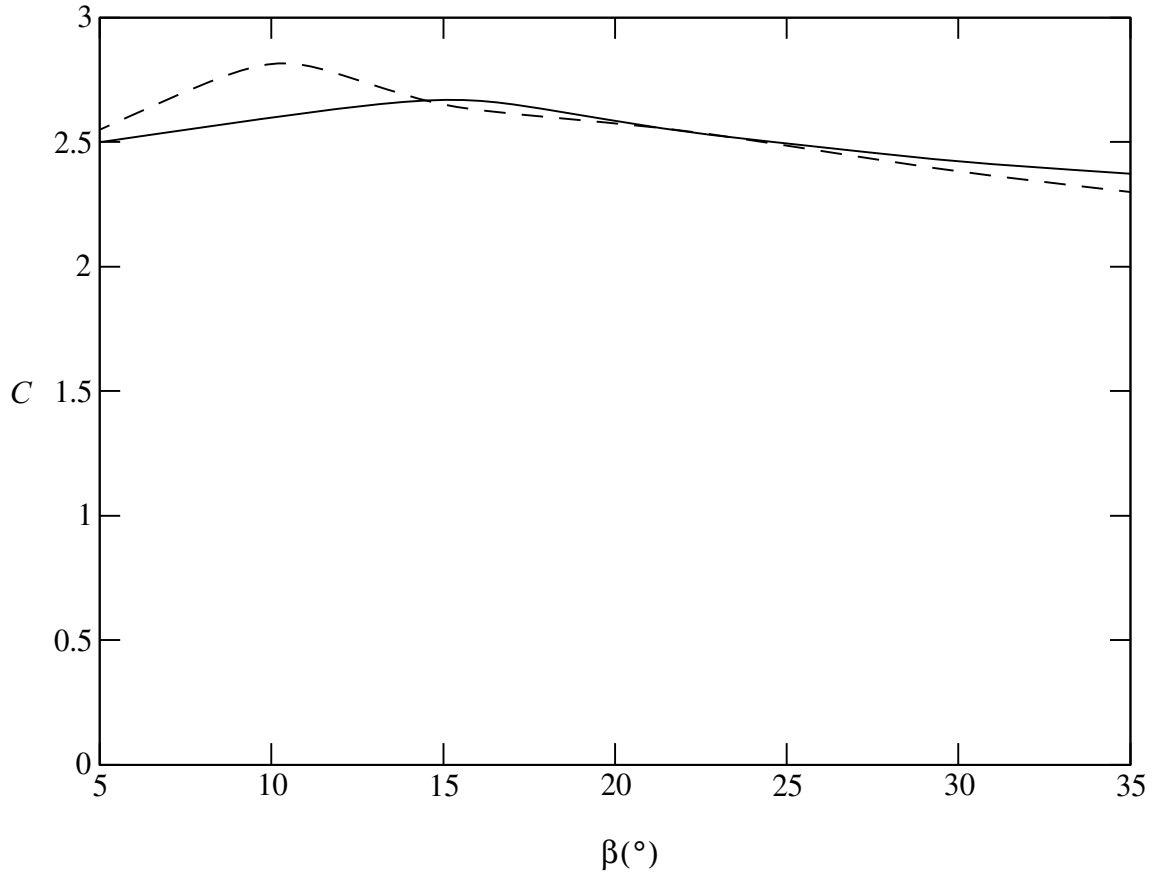

Figure 7

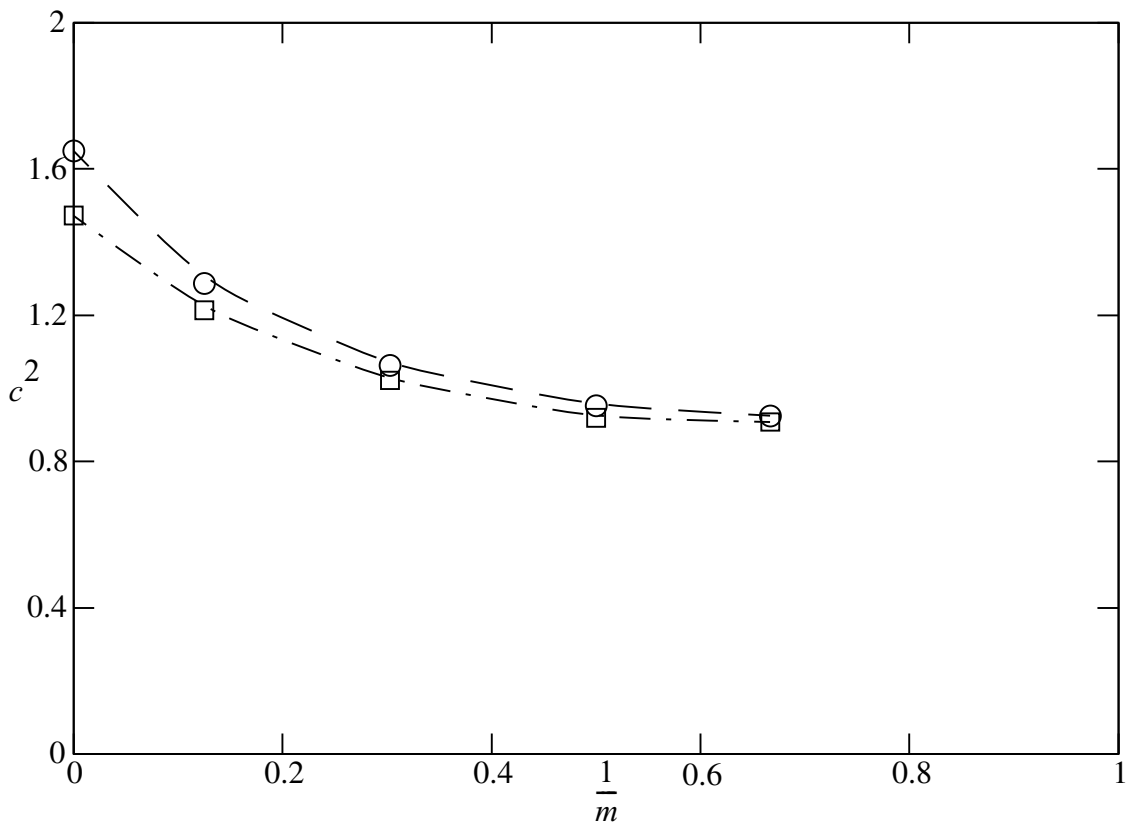

Figure 8

1
2
3
4
5
6
7
8
9
10
11
12
13
14
15
16
17
18
19
20
21
22
23
24
25
26
27
28
29
30
31
32
33
34
35
36
37
38
39
40
41
42
43
44
45
46
47
48
49
50
51
52
53
54
55
56
57
58
59
60

1
2
3
4
5
6
7
8
9
10
11
12
13
14
15
16
17
18
19
20
21
22
23
24
25
26
27
28
29
30
31
32
33
34
35
36
37
38
39
40
41
42
43
44
45
46
47
48
49
50
51
52
53
54
55
56
57
58
59
60

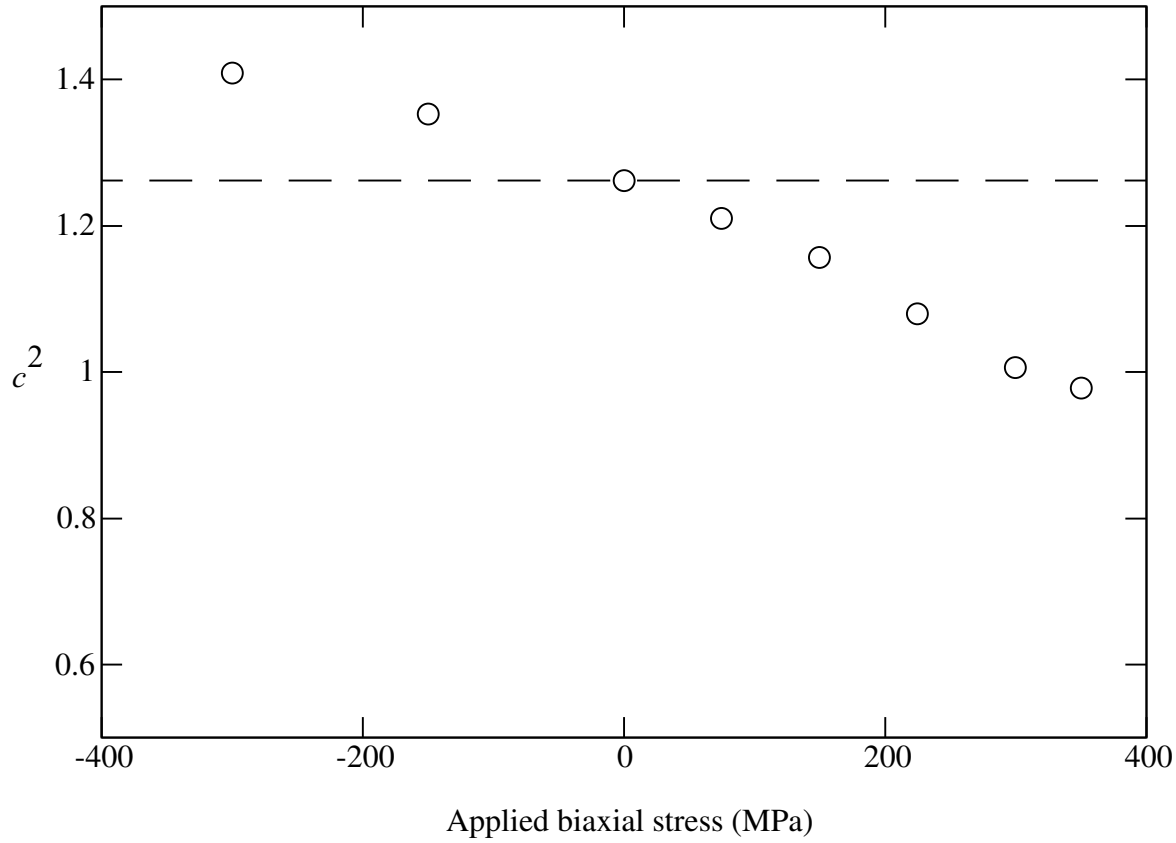

Figure 9

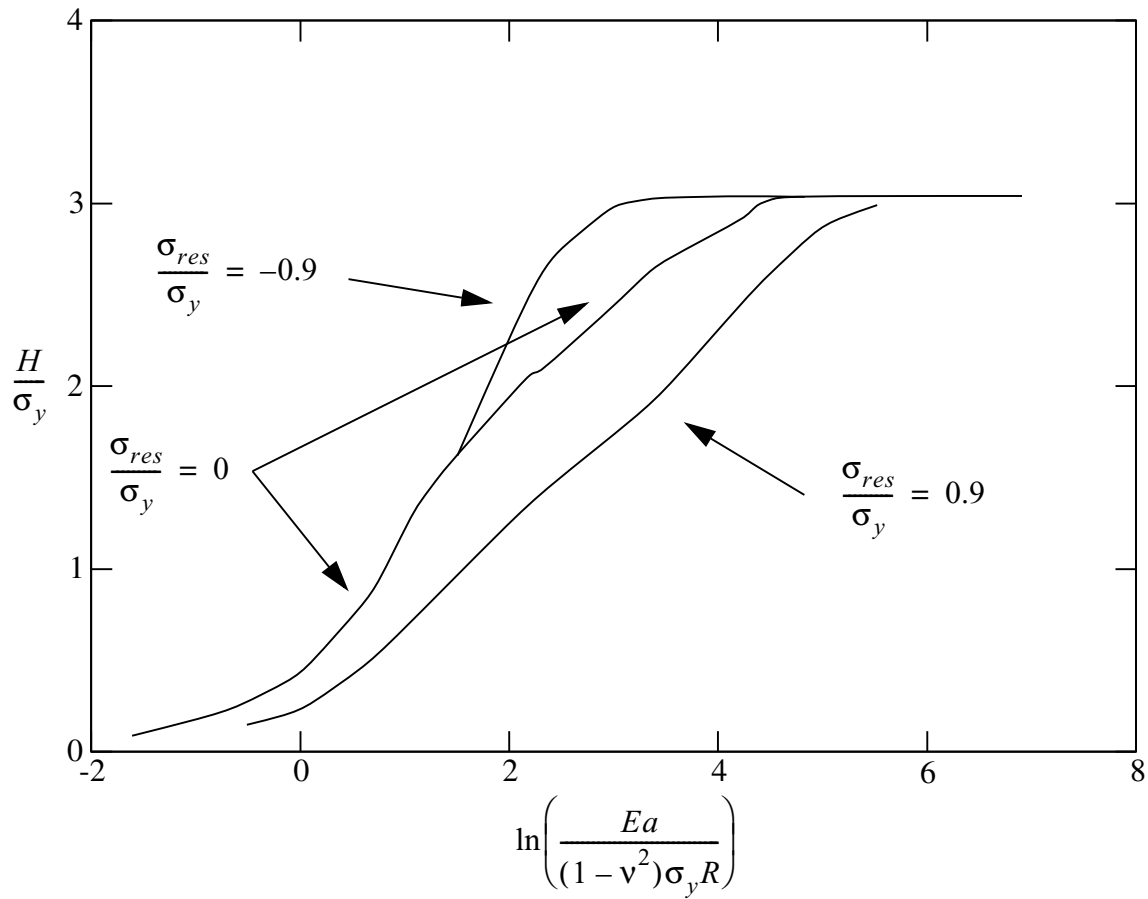

Figure 10

1
2
3
4
5
6
7
8
9
10
11
12
13
14
15
16
17
18
19
20
21
22
23
24
25
26
27
28
29
30
31
32
33
34
35
36
37
38
39
40
41
42
43
44
45
46
47
48
49
50
51
52
53
54
55
56
57
58
59
60

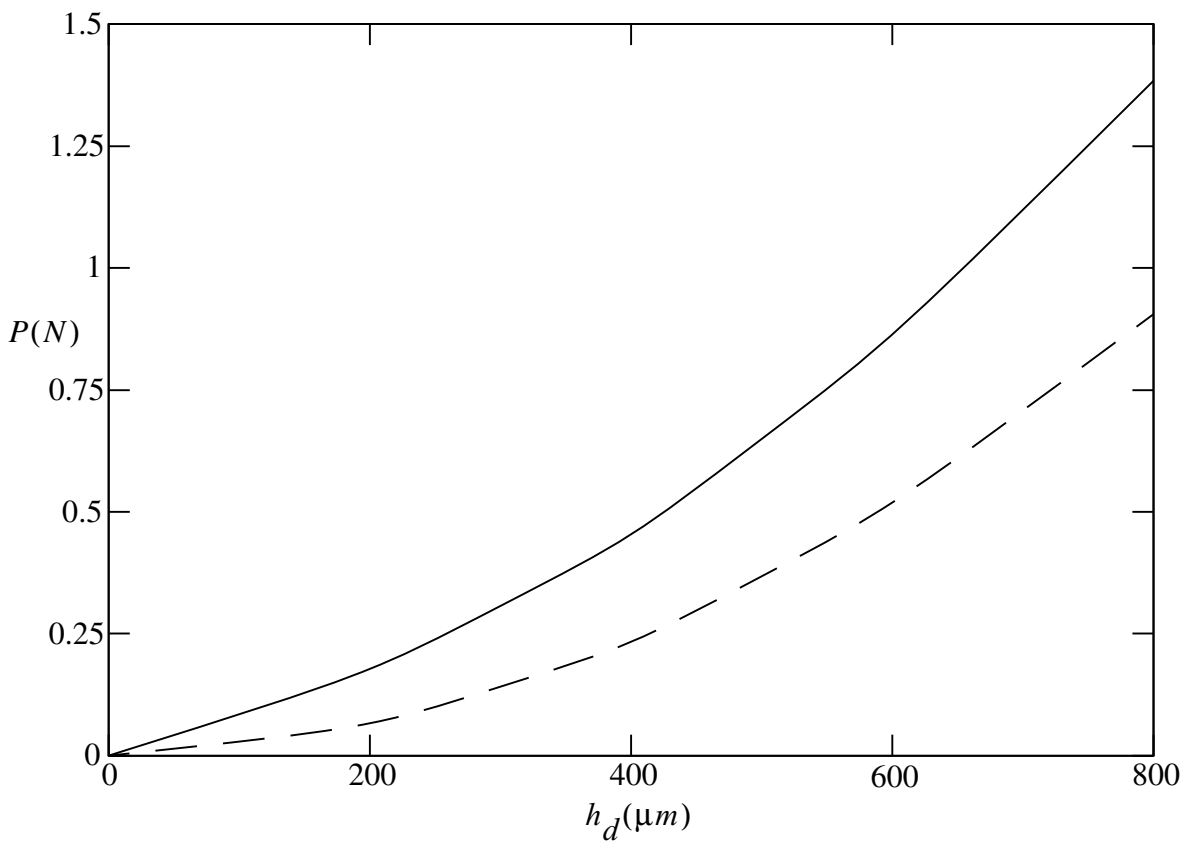

Figure 11

1
2
3
4
5
6
7
8
9
10
11
12
13
14
15
16
17
18
19
20
21
22
23
24
25
26
27
28
29
30
31
32
33
34
35
36
37
38
39
40
41
42
43
44
45
46
47
48
49
50
51
52
53
54
55
56
57
58
59
60

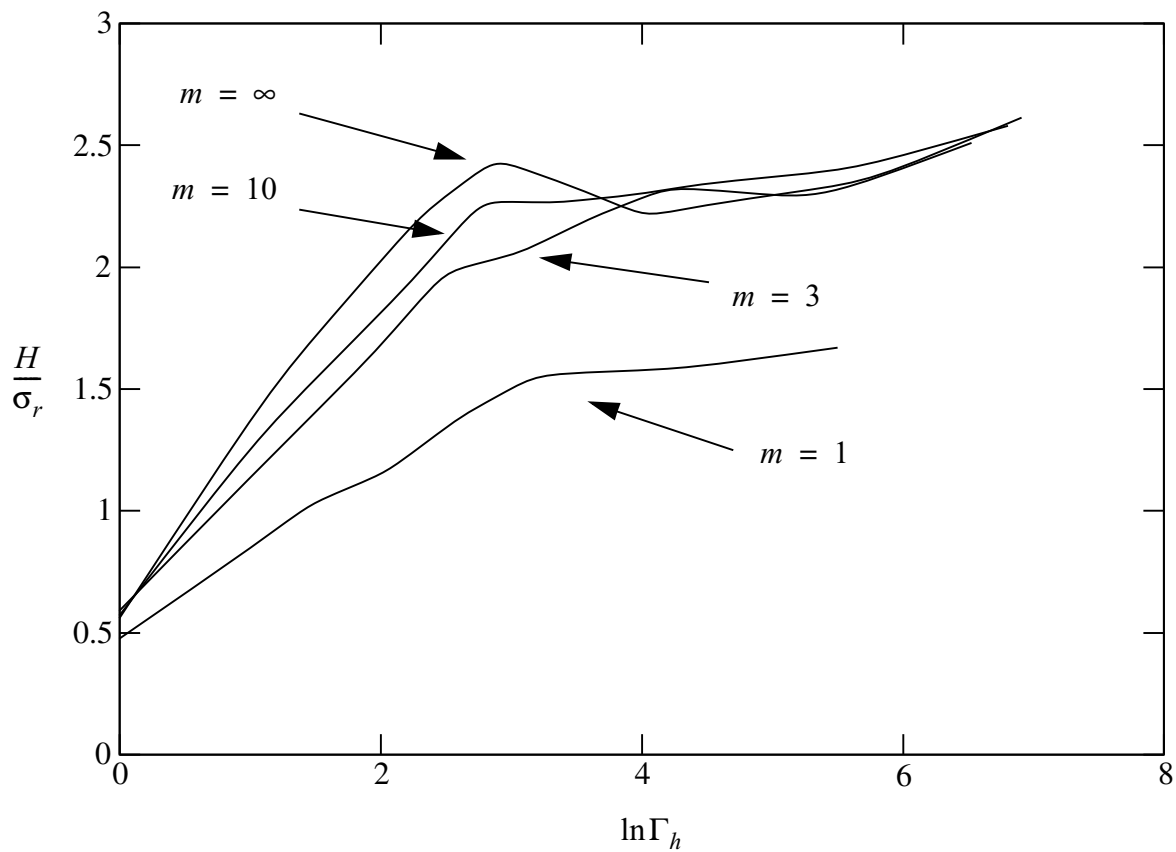

Figure 12