



**HAL**  
open science

## **FAIM2007 Special Issue: Capacity expansion decision in supply chains: A control theory application**

Xumei Yuan, Jalal Ashayeri

► **To cite this version:**

Xumei Yuan, Jalal Ashayeri. FAIM2007 Special Issue: Capacity expansion decision in supply chains: A control theory application. *International Journal of Computer Integrated Manufacturing*, 2009, 22 (04), pp.356-373. <10.1080/09511920802206419>. <hal-00513402>

**HAL Id: hal-00513402**

**<https://hal.science/hal-00513402v1>**

Submitted on 1 Sep 2010

**HAL** is a multi-disciplinary open access archive for the deposit and dissemination of scientific research documents, whether they are published or not. The documents may come from teaching and research institutions in France or abroad, or from public or private research centers.

L'archive ouverte pluridisciplinaire **HAL**, est destinée au dépôt et à la diffusion de documents scientifiques de niveau recherche, publiés ou non, émanant des établissements d'enseignement et de recherche français ou étrangers, des laboratoires publics ou privés.



HAL Authorization



**FAIM2007 Special Issue: Capacity expansion decision in supply chains: A control theory application**

Journal:	<i>International Journal of Computer Integrated Manufacturing</i>
Manuscript ID:	TCIM-2007-IJCIM-0149.R2
Manuscript Type:	Special Issue Paper
Date Submitted by the Author:	24-Apr-2008
Complete List of Authors:	Yuan, Xumei; Yanshan University, Department of Industrial Engineering Ashayeri, Jalal
Keywords:	SUPPLY CHAIN DYNAMICS, SYSTEM DYNAMICS
Keywords (user):	



## Capacity expansion decision in supply chains: A control theory application

X. Yuan<sup>a</sup> and J. Ashayeri<sup>b\*</sup>

<sup>a</sup> Department of Industrial Engineering, Yanshan University, China;

<sup>b</sup> Department of Econometrics & Operations Research, Tilburg University, The Netherlands

Received 1 January 2007; Final version received 17 March 2008

**Abstract.** The importance of capacity expansion decisions to lift constraints in parts of supply chains has increased significantly in recent years due to general ever-increasing performance requirements. Within a supply chain, insufficient capacity gradually leads to deteriorating delivery performance, and as a consequence, lowers revenue and market share. However, supply chain capacity expansion decisions are rather complex, and what should be taken into account includes not only the resources requirements but also the structure of the chain with its three main flows: goods, information and financial flows. Furthermore, for financial reasons, usually only limited investments can be made to expand capacities of a supply chain at one time. Therefore, it is critical to systemically address this decision by identifying the main (and mostly inter-dependent) factors affecting such a decision. This research proposes an approach to combine system dynamics loops and control theory simulations to thereby study and analyze the impacts of various factors on capacity expansion strategies within a supply chain. In order to identify those factors that play a key role in supply chain capacity expansion decisions, a set of control theory simulation experiments are designed. The study shows that financial reporting delays can distract capacity expansion decisions, which signifies that they are as important as delivery lead time, and can position a supply chain in distress by creating huge backlogs. It also shows that placing too much emphasis on sales force effectiveness (accurate forecasting) speeds up the reaction to demand changes and concludes that a balanced policy is desirable.

**Keywords:** Supply chains, capacity expansion, control theory, system dynamics

Deleted: Our

Deleted: ,

Deleted: The study

Deleted: ,

Deleted: concluding

### 1. Introduction

The widespread movement towards lean and agile supply chain is pulling many businesses into unfamiliar territory. Customers and competition are forcing supply chains to keep less inventory and resources, while simultaneously offering customers more flexibilities and shorter lead times. The result of such a move can be chaotic when capacity along the chain is not carefully designed. Effective capacity design has been increasingly emphasized because of the proven financial benefits that are gained from efficient customer response. Akkermans et al. (2003) consider capacity design as a one time decision. However, for many companies in a supply chain, it's inevitable to face demand for capacity expansion as an on-going decision, owing to technological developments, decreasing product life cycles, and a greater reliance on outsourcing. For financial reasons, only limited investments can be made in expanding the capacities of a supply chain at a time. Therefore, a balanced strategy is required to consider the proper rate of investment for capacity increases as opposed to other major investment decisions, such as increasing sales efforts to expand markets. The proper timing of these investment decisions impacts the revenue, the level of service provided, and the business growth. Accurate timing in expanding capacities will enhance the reliability of supply and delivery by independent business units within a chain. Therefore, the main actors in the supply chain must urgently resolve the tension between capacity deficit and economic profit, while ensuring sustainable business growth.

It was generally recognized that a good understanding of the dynamics of the constituent parts of a supply chain is the foundation of the design and operation of an efficient control strategy. Data analytic approaches are not effective in understanding dynamics in the supply chain, because the commercial environment changes too rapidly to permit the collection of consistent data series long enough to support statistical requirements. System dynamics modeling has a major role to play in supply chain design, especially at the aggregate level. Such modeling can help detect the missing feedback loops. In this paper, alternative supply chain modeling which in Control Engineering terms sometimes proved to be superior to system dynamics, namely Control Theory is used. The Forrester System Dynamics modeling enables us to gain important insights in the dynamic behavior of a system but our own experience with "live" supply chains shows that simulation modeling can be demanding and time consuming when neither historical data is available nor can be collected. The use of Control Theory can highlight areas of performance improvement, especially when combined with transfer function analysis for the areas with limited data or no data. This research proposes a framework for combining the system dynamics loops and control theory

\* Corresponding author. Email: j.ashayeri@uvt.nl

simulation to study and analyze the impacts of capacity expansion strategy systematically and quantitatively in a supply chain. A block diagram in which the sources of amplification may be diagnosed can replace the process of modeling of systems dynamics loops, and sensitivity analysis will allow measuring the impact of alternative solutions.

The purpose of the paper is twofold. The primary objective is to investigate the impact of capacity expansion decisions in supply chain and to increase the understanding of the effects of and interrelationships among the critical factors. The second objective is to show the use of control theory as a method to be applied to this type of problem.

This paper is organized as follows. First, the paper reviews briefly the main contributions relating to systems dynamics and control theory as simulation tools to study supply chain management problems. In Section 3, block diagram and transfer function description of Sterman's High-Tech Growth Firms' model are developed. In Section 4, a model of firm's capacity expansion process is developed based on adaptation of Sterman's model. This model depicts the process of capacity expansion, which includes many interacting parameters. In Section 5, sensitivity analysis of the improved model is made. Using orthogonal experimental design, the authors analyze the impact of each parameter. Then, the results are analyzed and explained. Finally, Section 6 presents the conclusions.

## 2. Literature review

### 2.1 Supply chain simulation

Simulation is used to model efficiently a wide variety of systems that are important to managers. One particularly fast-growing area of simulation applications lies in experiential games, nowadays referred to as "Board-Room Games". During the last decade simulation has been recognized as an important tool for modeling and analyzing supply chains, so much that all leading SCM software suites offer dynamic simulation module.

Simulation has been used as an effective means for analyzing dynamically changing internal supply chain variables to support the quantification of the benefits resulting from supply chain management (SCM) (Terzi & Cavalieri, 2004). Supply chain simulations can incorporate feedback processes and demonstrate the impact of supply chain dynamics, and then lead to insights into players' behavior, decisions making and supply chain dynamics. Also, simulation makes it possible to deploy holistic improvements through the supply chain, rather than partial or 'island' solutions.

Ingalls (1998) discussed why one would want to use simulation as the analysis methodology to evaluate supply chains, and its advantages and disadvantages against other analysis methodologies such as optimization and business scenarios. Approaches for system modeling and simulation fall into two broad categories: agent-based modeling (ABM) focuses on individuals (e.g., machines, people, company) that are related by behaviors, while equation-based modeling (EBM) focuses on observables (e.g. shipments per week, profit, delivery time) that are related by equations. Kleijnen (2005) distinguishes four simulation types for SCM: spreadsheet simulation, system dynamics, discrete-event dynamic system (DEDS) simulation and business games. For a literature survey of simulation in the supply chain context see (Terzi & Cavalieri, 2004) in which more than 80 papers have been reviewed. For supply chain simulation methods improving, one also can refer to Dalal et al. (2003), (Lee et al. (2002) and Conneely et al.(2004). In what follows the authors only briefly discuss the SD and control theory simulation literature.

### 2.2 System dynamics simulation

Based on information feedback and delays to understand the dynamic behavior of complex systems, System Dynamics (SD) is a computer-aided approach for analyzing and solving complex problems with a focus on policy analysis and design. As Angerhofer & Angelides (2000) summarized, SD has been applied to a wide range of problem domains, including work in corporate planning and policy design, economic behavior, public management and policy, biological and medical modeling, and supply chain management. For more details on System Dynamics, the reader is referred to Sterman (2000).

The use of SD modeling in supply chain has been very limited but recently given complexity in supply chains has gained increased popularity. A more recent overview of literature can be found in Ashayeri & Lemmens (2006) and Akkermans & Dellaert (2005). The former overviews the main papers in the field of SD modeling of SCM until 2004. The latter paper makes a brief review of SCM practice and theory for the past four decades and point at sensible and likely areas of further cross-fertilization of system dynamics and SCM.

Current research on SD modeling in supply chain management focuses on supply chain design and integration, bullwhip effect and information sharing, inventory decision and policy development, service supply chain management, procurement management, and closed-loop supply chain. Lyneis (2000) illustrates the proper use of system dynamics models for market forecasting and structural analysis, which can add value to clients. Ashayeri & Lemmens (2006) propose a system dynamics simulation modeling framework that allows managers to examine how improvements in demand reliability impact on the overall corporate bottom-line. Wilson (2002) applies system dynamics simulation to investigate the impact of five operational improvements in three supply chain scenarios: no information shared, VMI (vendor managed inventory), CPFR (collaborative planning, forecasting and replenishment). The results indicate that some partners benefit more by certain improvements, whereas others benefit less, and that reduced fluctuations in inventory depend on the type of improvement, the level of supply chain integration, and one's position in the supply chain. Croson & Donohue (2005) make an experiment to examine the

Deleted: we

Deleted: authors review

Deleted: we develop

Deleted: by improving Sterman's model, the authors

Deleted: we

Deleted: develop

Deleted: we make

Deleted: we

Deleted: We

Deleted: t

Deleted: the results

Deleted: we

Deleted: we

Deleted: are

Deleted: the reader

impacts of upstream inventory information sharing and downstream inventory information sharing. They find that only downstream information sharing leads to significantly lower order oscillations throughout the supply chain and upstream supply chain members benefit the most from downstream information sharing. Hilmola, Ojala & Norrman (2002) use SD model to analyze how synergies are going to be realized in the horizontal merger of two equally sized supply chains. Ovallea & Marquez (2003) develop a SD simulation model to explore and evaluate the advantages of a CONWIP-based supply chain policy, in comparison with a fully integrated supply chain. Marquez et al. (2004) develop comprehensive model of supply chain integration and use it to analyze and assess the operational and financial effectiveness of different e-collaboration tools at various levels of supply chain integration. Anderson et al. (2005) develop a capacity and backlog management model to investigate the dynamic behavior of service supply chains. Persson & Olhager (2002) evaluate alternative supply chain designs with respect to quality, lead-times and costs as the key performance parameters, and discuss the relationships among these parameters. Marquez & Blanchar (2004) study the procurement of strategic commodity-type parts and simulate three generic types of supplier contracts to accomplish varying degrees of security and flexibility. Georgiadis & Vlachos (2004) examine the impact of environmental issues on long-term behavior of a single product supply chain with product recovery using SD simulation model.

Many cases are also studied using system dynamics simulation method. Baumgaertel et al. (2001) make a simulation exercise at the DaimlerChrysler Corporation which identified a potential win-win situation for all partners along the supply chain if a new forecast policy is adopted. Akkermans & Vos (2003) report a case study from the telecommunication industry and aim to analyze relevant root causes and associated countermeasures of the amplification phenomenon in service supply chains. They find not all of the root causes and countermeasures of the amplification effects known from manufacturing research environments can be applied to service context. Akkermans (2001) studies opportunistic and partnership-driven attitudes in a supply network of ASML, which is the world's leading producer of advanced micro-lithographic manufacturing equipment. Cakravastia & Diawati (1999) propose a system dynamic model to facilitate assessment of logistic operating performance of shipbuilding industry in Indonesia. Higuchi & Troutt (2004) used SD to model the supply chain for the Japanese pet-toy called Tamagotchi. Ashayeri et al. (1998) model the distribution chain of Edisco (the European distribution arm of the US company Abbott Laboratories). Georgantzas (2003) simulates Cyprus' hotel value chain within the island's tourism custom-supplier value chain, and a SD simulation model helps test how Crypus' official strategy may affect tourist arrivals, hotel bed capacity and profitability. Holweg & Bicheno (2002) present the experiences of using supply chain simulations on an automotive steel supply chain. Ge et al. (2004) use SD approach to investigate the demand amplification problem of a supermarket chain in UK. Table 1 briefly summarizes current research on using SD modelling in supply chain.

[// place Table 1 here//](#)

### 2.3 Control Theory

Control theory (CT) is another approach to the deeper understanding of dynamic behaviour of systems. Classical control theory advocates a wide range of attributes and measures for proper design, such as stability, tracking ability and noise rejection and has developed various methods for describing and analyzing such systems.

As Towill (1982) mentioned, Simon (1952) first introduced control theory for the analysis of inventory and order-based production scheduling systems using the Laplace transform concepts to a single loop continuous time system, and after that, many authors followed. [A historical overview of using control theory in production and inventory control applications is given by Disney & Towill \(2002\). Contributions on replenishment rules and inventory fluctuations using transform techniques are described by Wikner et al. \(1991\), Grubbstrom \(1996, 2000\), Disney et al. \(2004\), Dejonckheere et al. \(2002, 2003, 2004\) and Lalwani et al. \(2006\). Table 2 briefly summarizes the historical development and also shows the increased interest in the use of CT in supply chain environment in recent years.](#)

It is noticeable from a literature search that contributions that utilize the Laplace transform are more numerous than those utilizing the z-transform. Disney et al. (2006) demonstrate that the management insights gained from both the continuous and discrete time approaches are very similar, and conclude that for practical purposes either time domain [can be used](#) in an analysis. Although the exact results may differ, their qualitative nature is essentially equivalent. This is particularly useful as questions that are difficult to analyze in one time domain may be easier in the other.

[// place Table 2 here//](#)

### 3. Control Theory simulation model of Sterman's High-Tech Growth Firms

The methodology used in this paper is control system engineering. In control systems engineering, the transfer function of a system represents the relationship describing the dynamics of the system under consideration. It algebraically relates a system's output to its input, which is easier to analyze and design. Disney & Towill (2002) provide an excellent summary of motives to use this particularly powerful method of systems analysis in supply chain, such as: (1) the use of standard forms simplifies benchmarking and promulgation of models describing best practice; (2) the judicious integration of transfer function techniques with simulation enables added insight into

Formatted: Indent: First line: 0 pt

Deleted: For a

Deleted: ,

Deleted: the authors

Deleted: we

Deleted: refer to

Deleted: The authors

Deleted: We

Deleted: also refer to

Deleted: for contributions on replenishment rules and inventory fluctuations using transform techniques

Deleted: we may use

Formatted: Indent: First line: 0 pt, Space After: 0 pt

Formatted: Font: (Asian) SimSun, (Asian) Chinese PRC

Deleted: Table 2. Previous work applying CT in the field of supply chain (Updated from Disney & Towill, 2002) ¶

Reference

... [1]

system design; (3) there exists a number of techniques for transferring problems from one domain into another domain in order to gain insight from situations that have already been met and solved elsewhere. [An useful tutorial on constructing the transfer function of a system can be found in Nise \(1995\).](#)

Sterman's model (see chapter 15) of High-Tech Growth Firms is used for the initial part of our study. [The transfer function approach is used](#) to modeling the complex interactions between different parts of the firms' supply chain. For every control rule, a transfer function is developed that completely represents the dynamics of this particular rule. [The authors first replicate Sterman's model using transfer function techniques and make a simulation using Simulink in MATLAB.](#) By applying the same input and settings, a control theory simulation study is performed to validate whether our simulation provides the same results as the system dynamics model used by Sterman. Then, improvements on the model for our research purpose, is given in section 4.

### 3.1 Model logic---causal loop structure

In SD, the simplest possible model is always used to capture the key decision rules of the top executives. Figure 1 shows that the High-Tech firm system consists of three sectors, each representing a different organizational subunit: sales, order fulfillment and capacity acquisition.

[// place Figure 1 here//](#)

The original general causal loop of Sterman's model is depicted in Figure 2.

[// place Figure 2 here//](#)

### 3.2 Block diagram and transfer function description of the system

It is useful at this stage to describe the individual building blocks of the model. Later, [a discription will be given on how these blocks are assembled together.](#) In order to facilitate understanding, [only the highlights will be presented.](#)

#### 3.2.1 Order fulfillment

In Sterman's model, it is assumed that the firm manufactures a complex high-tech product and operates a build-to-order system, like a semi-conductor company. Orders are accumulated in a backlog until they could be produced and shipped. The actual average delay in delivering orders (the mean residence time of orders in the backlog) is given by the ratio of the backlog to the current shipment rate. The difference equations required to capture backlog levels and delivery delay are shown in Eqs. (1)~(2).

$$\text{backlog}(t) = \text{backlog}(t-1) + \text{order\_rate}(t) - \text{shipmen\_rate}(t) \quad (1)$$

$$\text{delivery\_delay}(t) = \text{backlog}(t) / \text{shipment\_rate}(t) \quad (2)$$

The two rates, say, *order\_rate* and *shipment\_rate*, are converted into backlog levels in the *s* domain by the integration term,  $1/s$ .

*shipment\_rate* is determined by production capacity and capacity utilization, which is a function of the ratio of the desired production to the capacity. These can be shown by Eqs. (3)~(4).

$$\text{shipment\_rate}(t) = \text{capacity}(t) * \text{capacity\_utilization}(t) \quad (3)$$

$$\text{capacity\_utilization}(t) = f[\text{desired\_production}(t) / \text{capacity}(t)] \quad (4)$$

Desired production rate depends on the backlog and the normal delivery delay—the normal time required to process, build and ship an order.

$$\text{desired\_production}(t) = \text{backlog}(t) / \text{normal\_delivery\_delay} \quad (5)$$

Operations managers must accommodate variations in demand through changes in the level of capacity utilization because capacity is not under their direct control and responds only slowly to senior management's decisions to invest. The higher the backlog, the higher the utilization rate, though of course, utilization saturates when the firm's plants are operating at the maximum rate. The assumed capacity utilization function is shown in Figure 3.

[// place Figure 3 here//](#)

#### 3.2.2 Capacity acquisition

Investments in capacity are expensive and largely irreversible. Senior managers are reluctant to invest until there is clear evidence of need and until they could be sure that any new capacity would not go unutilized. Capacity is assumed to adjust to the desired level of capacity with a third-order delay, which is shown in Eq. (6).

$$\text{capacity}(t) = \text{smooth3}[\text{desired\_capacity}(t), \text{capacity\_aquisition\_delay}] \quad (6)$$

This can be realized in *S* domain by a third-order lags as Eq. (7).

$$G_t(s) = \left( \frac{1}{1 + T_{ca}s} \right)^3 \quad (7)$$

Where,  $T_{ca}$  is 1/3 of the capacity acquisition delay. The desired capacity is formed by anchoring on current capacity, then adjusting it up or down on various pressures which are measured by the firm's perceived ability to deliver compared to its goal. The causal loop of capacity expansion is shown in Figure 4.

Deleted: The authors

Deleted: We

Deleted: also refer to

Deleted: (

Deleted: ,

Deleted:

Deleted: for a useful tutorial on constructing the transfer function of a system.

Formatted: Font: (Asian) SimSun, (Asian) Chinese PRC

Deleted: We use

Deleted: a

Deleted: We

Deleted:

Deleted: we

Deleted: the authors make some

Deleted: , which

Deleted: ¶

<sp>

Formatted: Font: (Asian) SimSun, (Asian) Chinese PRC

Deleted: Figure 1. Sectors of the Sterman's Model.¶

Deleted: ¶  
Figure 2. The original causal loop of Sterman's model.¶  
¶

Formatted: Font: (Asian) SimSun, (Asian) Chinese PRC

Deleted: it will be

Deleted: we will

Deleted: described how

Deleted: we will

Deleted: present

// place Figure 4 here//

$$\text{desired\_capacity}(t) = \text{capacity}(t-1) * \text{effect\_of\_expansion\_pressure\_on\_desired\_capacity}(t) \quad (8)$$

$$\text{effect\_of\_expansion\_pressure\_on\_desired\_capacity}(t) \quad (9)$$

$$= f[\text{pressure\_to\_expand\_capacity}(t)]$$

$$\text{pressure\_to\_expand\_capacity}(t) = \frac{\text{delivery\_delay\_perceived\_by\_company}(t)}{\text{company\_goal\_for\_delivery\_delay}} \quad (10)$$

$$\begin{aligned} \text{delivery\_delay\_perceived\_by\_company}(t) &= \\ &= \text{delivery\_delay\_perceived\_by\_company}(t-1) + \\ & \frac{[\text{delivery\_delay}(t) - \text{delivery\_delay\_perceived\_by\_company}(t-1)]}{\text{time\_for\_company\_to\_perceive\_delivery\_delay}} \end{aligned} \quad (11)$$

The pressure to expand capacity has a nonlinear effect on desired capacity, as shown in Figure 5.

// place Figure 5 here//

Eq. (11) can be realized in  $s$  domain using first-order lag, which is shown in Eq. (12).

$$G_2(s) = \left( \frac{1}{1 + T_c s} \right) \quad (12)$$

Where,  $T_c$  is the time for company to perceive delivery delay.

### 3.2.3 The sales force

A part of the revenue of the firm is invested in the sales force. Shipment and price of the product determine the revenue. Sales budget is based on expected revenues, which are regularly updated and are modeled by smoothing actual revenue with a revenue reporting delay.

$$\text{revenue}(t) = \text{price} * \text{shipment\_rate}(t) \quad (13)$$

$$\begin{aligned} \text{expected\_revenue}(t) &= \\ \text{expected\_revenue}(t-1) &+ \frac{[\text{revenue}(t) - \text{expected\_revenue}(t-1)]}{\text{revenue\_reporting\_delay}} \end{aligned} \quad (14)$$

Eq. (14) can be realized in  $s$  domain by first-order lags as Eq. (15).

$$G_3(s) = \left( \frac{1}{1 + T_r s} \right) \quad (15)$$

Where,  $T_r$  is the revenue reporting delay. So,

$$\text{sales\_budget}(t) = \text{fraction\_of\_revenue\_to\_sales} * \text{expected\_revenue}(t) \quad (16)$$

The target sales force, that is, the number of sales representatives the sales organization can support, is determined by the sales budget and the average cost of a sales representative.

$$\text{target\_dales\_force}(t) = \frac{\text{sales\_budget}(t)}{\text{cost\_per\_dales\_representative}} \quad (17)$$

The actual sales force adjusts to the target sales force through the net hiring rate.

$$\text{sales\_force}(t) = \text{sales\_force}(t-1) + \frac{[\text{target\_sales\_force}(t) - \text{sales\_force}(t-1)]}{\text{sales\_force\_adjustment\_time}} \quad (18)$$

Eq. (18) can be realized in  $s$  domain by first-order lags.

$$G_4(s) = \frac{1}{1 + T_s} \quad (19)$$

Where,  $T_s$  is sales force adjustment time.

### 3.2.4 The market

The order rate depends on sales force and their effectiveness as measured by orders booked per person per month:

$$\text{order\_rate}(t) = \text{sales\_force}(t) * \text{sales\_effectiveness}(t) \quad (20)$$

For simplicity, sales effectiveness is assumed to depend only on the availability of the product measured by delivery delay.

$$\text{sales\_effectiveness}(t) = \text{normal\_sales\_effectiveness} * \text{effect\_of\_availability\_on\_sales\_effectiveness}(t) \quad (21)$$

$$\text{effect\_of\_availability\_on\_sales\_effectiveness}(t) = f\left(\frac{\text{delivery\_delay\_perceived\_by\_market}(t)}{\text{market\_target\_delivery\_delay}}\right) \quad (22)$$

$$\begin{aligned} \text{delivery\_delay\_perceived\_by\_market}(t) = & \\ \text{delivery\_delay\_perceived\_by\_market}(t-1) + & \\ \frac{[\text{delivery\_delay\_perceived\_by\_company}(t) - \text{delivery\_delay\_perceived\_by\_market}]}{\text{time\_for\_market\_to\_perceive\_delivery\_delay}} & \end{aligned} \quad (23)$$

The availability of product is measured by the ratio of delivery delay perceived by market to market target delivery delay and has a nonlinear effect on sales effectiveness, as shown in Figure 6.

[// place Figure 6 here//](#)

Eq. (23) can be realized in  $s$  domain using first-order lag, which is shown in Eq. (24).

$$G_s(s) = \frac{1}{1 + T_m s} \quad (24)$$

Where,  $T_m$  is the time for market to perceive delivery delay.

### 3.2.5 The block diagram of the full system

The block diagram of the whole system is shown in Figure 7. It describes, in a structured pictorial form, how the individual policies described earlier fit together to form the whole firm's operating environment.

[// place Figure 7 here//](#)

Of particular interests in the block diagram are the backlog, capacity and revenue signals. Setting the simulated time period as 10 years (120 months), with the same parameters as Sterman's original model, ~~the authors~~ get the same results, which are shown in Figure 8. This validates our modeling process and demonstrates the effectiveness of using transfer function technique to model business progress, which is more powerful compared with SD.

Deleted: we

[// place Figure 8 here//](#)

The simulation results from SD and CT validate our CT modeling process and demonstrate the effectiveness of using transfer function technique to model business progress. From the case study, ~~it is clear~~ that (1) it is very easy to form CT simulation model of supply chain processes with transfer function; (2) CT model relies on a few assumptions, less data is needed; (3) the form of transfer function is very neat, and it separates the input, output and system into separate parts which allows us to algebraically combine mathematical representations of subsystems to yield a total system representation for ease analysis and design which cannot be obtained with differential equation; (4) transfer function yields more intuitive information, then ~~system parameters~~ ~~can be changed and their effects on~~ ~~the the system response are sensed rapidly~~.

Deleted: we can also see

Deleted: we are able to change

Deleted: and rapidly

Deleted: the effect of these changes on the system response

## 4. Improvement on Sterman's model

The Sterman's model was meant only to illustrate economic growth considering two interacting investment decisions, namely capacity expansion and sales enlargement. The basic simulation results of this model clearly show that after 10 years simulation the backlog is almost seven times the capacity, which is not acceptable in reality because the large backlog would sway the customer towards the competitors. In order to characterize a reps in the original model, ~~some improvements~~ ~~are made~~, as shown in Figure 9.

Deleted: we made

[// place Figure 9 here//](#)

### 4.1 Price=f(capacity,backlog)

In Sterman's model, the price of the product is assumed to be constant, but in fact, with higher capacity, the quantity of products produced will be lower. According to the theory of economics, the price of the product will be lower. That means, the price is a function of capacity as shown in Figure 10. Berends & Romme (2001) also shows this relationship.

[// place Figure 10 here//](#)

Furthermore, the level backlog also has an effect on the price of product, which can be shown in Figure 11. This hints when the backlog is larger than the normal deliver delay, or the larger the waiting, the higher the price.

// place Figure 11 here//

$$\begin{aligned} price(t) &= f[capacity(t), backlog(t)] \\ &= f_1[capacity(t)] \times f_2\left[\frac{backlog(t)}{normal\_delivery\_delay * 80\% * capacity(t)}\right] \end{aligned} \quad (25)$$

Formatted: Font: (Asian) SimSun, (Asian) Chinese PRC

#### 4.2 Sales effectiveness=f(delivery delay, price)

Sales effectiveness depends on the attractiveness of the product, which depends on a host of attributes, including availability, price, financing terms, quality, support and service, and so on. For simplicity, the original model assumes attractiveness depends only on the availability of the product, which is measured by delivery delay. This is not consistent with the literature on Bullwhip effect, called "Customer Gaming", which suggests when the delivery performance decreases, customers tend to order larger quantities to guarantee their requirements and therefore even the best efforts placed for improving sales effectiveness (increasing investment in personnel or better forecasting) will not produce better situation. Therefore, if there is a substitute supply source, the order size will decrease, otherwise it will not. ~~The former is assumed in the case experiments.~~

In this improved model, in addition to the availability of the product, the sales effectiveness also depends on the price of the product. Through sales effectiveness, the price can influence the order rate. The price has a non-linear effect on sales effectiveness as shown in Figure 12.

// place Figure 12 here//

Then, the sales effectiveness is as follow:

$$\begin{aligned} sales\_effectiveness(t) &= normal\_sales\_effectiveness * \\ &[w_1 * effect\_of\_availability\_on\_sales\_effectiveness(t) + \\ &w_2 * effect\_of\_price\_on\_sales\_effectiveness(t)] \end{aligned} \quad (26)$$

Where,  $w_1$  and  $w_2$  are weights, which satisfy  $w_1 + w_2 = 1$ .

#### 4.3 Effect of expansion pressure on capacity correction

Once the capacity is acquired, it cannot be discarded or reduced unless an outsourcing option is used and even then some penalties are involved for immediate exit from the contracts. Therefore, expansion pressure would not have immediate impact on the desired capacity as shown in Figure 4. The capacity available is always utilized fully before expanding, and as such the lower bound of the effect of expansion pressure on capacity should be one. This is shown in Figure 13.

// place Figure 13 here//

#### 4.4 Sales force investment policy

The policy for investment in sales force is a very important factor for the stability of the backlog in the system. If ~~fixed value investment policy is used, such as setting the fraction of revenue to sales force to be 20%, the backlog is always out of control. For some cases, it is more than 5 times of the capacity. When the backlog is higher than what is expected, investment should not be put into sales force. The backlog should have an effect on sales force, as shown in Figure 14.~~

$$\begin{aligned} fraction\_of\_revenue\_to\_sales\_force(t) &= \\ f\left[\frac{backlog(t)}{normal\_delivery\_delay * 80\% * capacity(t)}\right] \end{aligned} \quad (27)$$

// place Figure 14 here//

#### 4.5 Shipment policy

For the shipment rate, ~~the same policy as beer game is used, in which shipment rate is decided considering the capacity of the firm and the sum of order rate and backlog. If the sum of order rate and backlog is larger than the capacity of the firm, the firm will produce products at full capacity, and the shipment rate equals to the capacity. Otherwise, the shipment rate equals to the sum of order rate and backlog. This is shown in Eq. (28).~~

$$shipment\_rate(t) = \min[capacity(t), order\_rate(t) + backlog(t - 1)] \quad (28)$$

### 5. Experiments

Deleted: We

Deleted: assume t

Deleted: our

Formatted: Font: (Asian) SimSun, (Asian) Chinese PRC

Deleted: we use

Deleted: then

Deleted: we

Deleted: we use

In this section, the authors present an experimental set of scenario runs to test the impacts of factors on capacity expansion decisions.

Deleted: we

### 5.1 Experiments design based on fractional factorial orthogonal arrays

The fractional factorial orthogonal array is a method of setting up experiments that only requires a fraction of the full factorial combinations. The term array simply refers to a mathematically derived matrix arrangement that constrains the way all the parameter set points are set up prior to running the experiment. An orthogonal array imposes an order on the way the matrix of experiments is carried out; orthogonal refers to the balance between the various combinations of parameters so that no one parameter is given more or less opportunity to express its effect on the response in the experiment than any of the other parameters. Orthogonal also refers to the fact that the effect of each parameter can be mathematically assessed independent of the effects of the other parameters.

### 5.2 Factors choosing

The authors perform an analysis of the behavior of capacity, backlog and revenue for different values of some factors. The choice of factors is rather a complicated process with an abundance literature, each suggesting a number of factors relating to their environment settings. For example, Rajagopalan & Swanminathan (2001) investigate the impact of production variety, cost of capital, capacity size, initial capacity multiple, holding cost, set-up time, and capacity purchase cost multiple on capacity acquisition decision in an environment with demand growth. Paik (2005) incorporates nine causes of the bullwhip effect as the variables in a simulation model and seeks to investigate the relationship between each of the causes and the severity of their effect on the bullwhip effect. He considers level of safety stock, timing of batch, multiple ordering, material delay, information delay, maximum capacity, production delay, average waiting time before purchasing, and number of echelons. Power & Sohal (2001) identify a total of 43 variables as relevant to agility, supply chain management practices and specific organizational performance outcomes of interest, and separate them into independent and dependent categories. Anderson et al. (2005) study the impact of service delay, capacity adjustment time, relative weights of end-customer demand and local demand in the target capacity decision, fractional effect of backlog on demand, and the coefficient of variation in the end-customer demand in a capacity management model of a two-stage serial service supply chain.

Deleted: We

This research investigates the capacity expansion decisions in supply chains. Eight factors are chosen, namely time for company to perceive delivery delay (P1), time for market to perceive delivery delay (P2), customer expected price (P3), importance weights for product availability impact and for price impact on the sales effectiveness (P4), capacity acquisition delay (P5), revenue reporting delay (P6), sales force adjustment time (P7), and normal delivery delay (P8). By changing the value of these eight factors, this study seeks to investigate the relationship between the factors and the severity of their effects on the capacity expansion decisions.

Deleted: We choose

Deleted: e

### 5.3 Experiment design

A factorial arrangement with the 8 chosen factors each at 3 levels is proposed as shown in Table 3, and a complete factorial experiment requires  $3^8 = 6561$  runs. However, since the number of runs required is so large that it is not economical to carry out the complete factorial experiment, fractional factorial is used. Using the Principle of orthogonal design, the authors choose the orthogonal form of  $L_{27}(3^{13})$  and get Table 4.

Deleted: we choose

[// place Table 3 here//](#)

Deleted: we

[// place Table 4 here//](#)

### 5.4 Experiment analysis

After running the 27 experiments and comparing the results from the revenue point of view, run 6, run 11, run 12 and run27 are considered outperforming runs. Figures 15 to 18 show the results of these four runs.

Formatted: Font: (Asian) SimSun, (Asian) Chinese PRC

Deleted: Table 3. 3 levels of the 8 factors.!

Levels

... [2]

[// place Figure 15 here//](#)

[// place Figure 16 here//](#)

[// place Figure 17 here//](#)

[// place Figure 18 here//](#)

Deleted: By comparing

Deleted: with

Deleted: we can see

Deleted: ing

Deleted: with

Deleted:

Deleted: , we can see

Deleted:

Through comparison between run 12 and run 27, it is evident that delay in revenue-reporting compensates or impacts sales adjustment time. Comparison between revenue-reporting delay and normal delivery delay shows revenue-reporting delay can compensate normal delivery delay. In other words, financial reporting delays can put off capacity expansion decisions, signifying they are as important as delivery lead-time and can position supply chain in distress (huge backlogs).

Using a monthly discount rate of 0.1%, the NPV (Net Present Value) for all runs are calculated. The NPV of run6, run11, run12 and run27 are shown in Table 5.

[// place Table 5 here//](#)

#### 5.4.1 Experiments on Run12

Table 5 shows that the NPV of run12 is the largest. ~~The effect of each factor to the level of sensitivity can be obtained through changing one at one time.~~ The results are shown in Table 6.

[// place Table 6 here//](#)

Changing P1 (time for company to perceive delivery delay) and P2 (time for market to perceive delivery delay) respectively ~~has no obvious impact on the stability of the backlog.~~ Bringing down P1 or bringing up P2 increases the NPV. The impact of P1 is relatively bigger than P2.

With P3 (the customer expected price) being brought down, NPV becomes much lower.

~~Changing P4 importance weights makes the NPV of the system much higher when the price of the product gets a more important weight than the availability of the product impact on sales effectiveness (in other words, the sales effectiveness is more sensitive to the price of the product).~~ Figure 19 shows that when sales effectiveness is more impacted by price (through more weight, P4), the capacity expansion decisions are taken earlier, creating more room for production and bringing the product price down, which in turn increases the total revenue.

[// place Figure 19 here//](#)

~~Decreasing P5 (the capacity acquisition delay) dramatically increases the NPV because of the quick acquisition of the capacity.~~

P6 (revenue-reporting delay) is responsible for the reaction times in capacity change. The shorter the delay, the faster is reaction to capacity expansion need, which is quite logical. Moreover, the shorter revenue reporting delay results in a larger NPV. This all suggests that financial reporting delay which is typically rooted in sorting out the Account Receivable (AR) and Account Payable (AP) can put supply chain in trouble, necessitating speeding up this process. A recent surge in SCM software solutions integrating financial flows is a witness to this conclusion (SAP, March 2006).

P7 (sales force adjustment time) is very responsible for the trend and the amplitude of backlog. Bringing it down decreases the oscillation of the backlog but with the cost of NPV. The shorter this period, the shorter on average backlog stays at zero status. ~~as is shown from Run 6.~~ Compared with other runs, Run 6 has very high NPV, but oscillation of the backlog is huge. With the sales force adjustment being changed to 12 and 6 respectively, the performance gets better.

P8 (Normal delivery delay) means goal of the delivery delay or expected lead-time. The longer it is, the lower is the NPV.

#### 5.4.2 Range analysis

Using the revenue as the indicator and neglecting the interactions between the factors, ~~the authors~~ calculate the range of each factor, which is shown in Table 7.

[// place Table 7 here//](#)

Where,

$$k_{ji} = \frac{\sum_{j=1}^8 \text{cumulative\_revenue}}{9} \quad (j = 1, 2, \dots, 8) \quad (i = 1, 2, 3)$$

$$R_j = \max\{k_{ji}\} - \min\{k_{ji}\} \quad (j = 1, 2, \dots, 8) \quad (i = 1, 2, 3)$$

It shows the best combination of all the factors is (1,12,10000, (0,9,0.1), 6,1,6,1). This experiment is also reported in Figure 20 and provides the same conclusions as discussed for the setting of Run12.

[// place Figure 20 here//](#)

## 6. Summary and conclusions

In today's highly unpredictable markets, firms are faced with the decision of matching supply with demand in the most profitable way. Supply chain capacity expansion is an expensive and rather complex decision, but too often it is overly simplified by merely adding a machine or an extra resource. This paper provides a simple conceptual framework to better understand the interaction of important factors on capacity expansion decisions. According to the conceptual framework, the main causal loops of the decision making process are drawn, and then translated into a control theory model, which can be easily simulated without extensive data requirements.

In this paper, using Serman's High-Tech Growth model as a starting point of our study, ~~the authors~~ argued that not only the resources but also the structure of the chain ~~need to be taken into account~~, considering three flows: goods, information, and funds. Therefore, it is more important to address capacity expansion systemically by identifying the main (and mostly inter-dependent) factors affecting such decisions. The hierarchies of capacity

Deleted: For this run by changing each factor at a time, the authors

Deleted: we can

Deleted: get

Deleted: t

Deleted: ,

Deleted: we can see

Deleted: both of them have

Deleted: By

Deleted: c

Deleted: , we can see

Deleted: that when the price of the product gets a more important weight than the availability of the product impact on sales effectiveness

Deleted: the NPV of the system is much higher (in other words, the sales effectiveness is more sensitive to the price of the product)

Deleted: ¶ ... [3]

Formatted: Font: (Asian) SimSun, (Asian) Chinese PRC

Deleted: . We can also see this

Deleted: we

Deleted: can

Formatted: Font: (Asian) SimSun, (Asian) Chinese PRC

Deleted: we

Deleted: we need to take into account

expansion can be seen as changes needed in: a) structures, systems and roles, b) resources (like machines, staff, etc.), and c) operating rules. Emphasizing on systemic capacity expansion and planning would improve identification of shortcomings in specific parts of supply chain design and monitoring, and would lead to more effective use of resources.

Based on the improved Serman's High-Tech Growth model, a set of control theory simulation experiments is designed to identify the factors that play a key role in supply chain capacity expansion decisions. Among the highlighted results, the study clearly shows a strong correlation between supply chain financial flow delays, commercial (marketing & sales) delays, and the goods flow delivery delays. It suggests that an increase in financial flow delays (like reporting) diminish the effectiveness of goods flow improvement. In other words, capacity expansion or improving physical resources will not be very effective. Among other interesting results, the study shows that commercial delays (like sales force adjustment time) is very responsible for the trend of the amplitude of backlog. Bringing it down would decrease the oscillation of the backlog in the chain. This means that sales efforts and related investment should be made in light of backlog or capacity available -- not totally independent.

Deleted: we designed

According to the study, a balanced approach is needed to expand capacity for economic growth. Without sufficient capacity or proper utilization capacity rates, the supply chain will not grow. The success of the supply chain is highly dependent on capacity availability and inter-company cooperation shown by structural delays in the simulation model. In addition, the model shows that supply chains need to assess their entire system assumptions and roles more closely if they want to minimize unexpected policy outcomes. Simple investment in resources will not be sufficient and may have negative effects.

Deleted: our

Deleted: We can further conclude that

Deleted: w

In this paper, the authors tested the validity of using control-theoretic models in a supply chain environment. In future research it might be interesting to design a supply chain controller using control theory. Another research path is to extend this study and examine a multi-echelon supply chain system.

Deleted: we

## References

- Akkermans, H. A., Bogerd, P., Yucsan, E. L. and Wassenhove, N. V., 2003. The impact of ERP on supply chain management: Exploratory findings from a European Delphi study. *European Journal of Operational Research*, 146(2), 284-301.
- Akkermans, H. and Dellaert, N., 2005. The rediscovery of industrial dynamics: the contribution of system dynamics to supply chain management in a dynamic and fragmented world. *System Dynamics Review*, 21(3), 173-186.
- Akkermans, H. and Vos, B., 2003. Amplification in service supply chains: An exploration case study from the telecom industry. *Production and Operations*, 12(2), 204-223.
- Akkermans, H., 2001. O tell me the truth about trust: An agent-based system dynamics simulation of opportunistic and partnership-driven attitudes in a high-tech supply network. *HICSS conference*.
- Anderson, E. G., Morrice, D. J. and Lundeen, G., 2005. The "physics" of capacity and backlog management in service and custom manufacturing supply chains. *System Dynamics Review*, 21(3), 217-247.
- Angerhofer, B. J. and Angelides, M. C., 2000. System dynamics modeling in supply chain management: Research review. *Proceedings of the 2000 Winter Simulation Conference*. 342-351.
- Ashayeri, J., Keij, R. and Broker A., 1998. Global business process re-engineering: a system dynamics based approach. *International Journal of Operations and Production Management*, 8(9/10), 832-864.
- Ashayeri, J. and Lemmens, L., 2006. Economic value added of supply chain demand planning: A system dynamics simulation. *Robotics and Computer Integrated Manufacturing*, 22(5-6), 550-556.
- Baumgaertel, H., Brueckner, S., Parunak, V., Vanderbok, R. and Wilke, J., 2001. *Agent models of supply network dynamics- Analysis, design, and operation* [online]. DaimlerChrysler Corp., Research , Technology. Available from: <http://www.damas.ift.ulaval.ca/~moyaux/bibtex/baumgaertel01.pdf> [Accessed 26 August 2007]
- Berends, P. A. J. And Romme, A. G. L., 2001. Cyclicity of capital-intensive industries: A system dynamics simulation study of the paper industry. *Omega*, 29(6), 543-552.
- Bienstock, D., Raskina, O., Saniee, I., and Wang, Q., 2006. Combined network design and multiperiod pricing, modeling, solution techniques, and computation. *Operations Research*, 54(2), 261-276.
- Cakravastia, A., , Diawati, L. 1999. *Development of system dynamic model to diagnose the logistic chain performance of shipbuilding industry in Indonesia* [online]. Available from: <http://www.systemdynamics.org/conf1999/PAPERS/PARA74.PDF> [Accessed 20 May 2006]
- Conneely, B., Duggan, J., , Lyons, G. J. 2004. *A Gaming Approach to Supply Chain Simulation* [online]. NUI, Galway Faculty of Engineering Research Day 2004. Available from: <http://corrib.it.nuigalway.ie/ResearchDay2004/infotech/ConneelyBryan.pdf> [Accessed 30 August 2007]
- Croson, R. and Donohue, K., 2005. Upstream versus downstream information and its impact on the bullwhip effect. *System Dynamics Review*, 21(3), 249-260.
- Dalal, M. A., Bell, H., Denzien, M., , Keller, M. P. 2003. Initializing a distribution supply chain simulation with live data. *Proceedings of the 2003 Winter Simulation Conference*. 1621-1626.

- Dejonckheere, J., Disney, S. M., Lambrecht, M. R. and Towill, D. R., 2002. Transfer function analysis of forecasting induced bullwhip in supply chains. *Int. J. Production Economics*, 78(2), 133-144.
- Dejonckheere, J., Disney, S. M., Lambrecht, M. R. and Towill, D. R., 2003. Measuring and avoiding the bullwhip effect: A control theoretic approach. *European Journal of Operational Research*, 147(3), 567-590.
- Dejonckheere, J., Disney, S. M., Lambrecht, M. R. and Towill, D. R., 2004. The impact of information enrichment on the Bullwhip effect in supply chains: A control engineering perspective. *European Journal of Operational Research*, 153(3), 727-750.
- Disney, S. M. and Towill, D. R., 2003. On the bullwhip and inventory variance produced by an ordering policy. *Omega*, 31(3), 157-167.
- Disney, S. M., Towill, D. R. and Velde, W. V. D., 2004. Variance amplification and the golden ratio in production and inventory control. *Int. J. Production Economics*, 90(3), 295-309.
- Disney, S. M., Towill, D. R., Warburton, R. D. H. 2006. On the equivalence of control theoretic, differential, and difference equation approaches to modeling supply chains. *Int. J. Production Economics*, 101(1), 194-208.
- Disney, S.M., Towill, D.R. 2002. A discrete linear control theory model to determine the dynamic stability of vendor managed inventory supply chains. *Int. J. Production Research*. 40 (1), 179-204.
- Ge, Y., Yang, J.B., Proudlove, N. and Spring, M. 2004. System dynamics modeling for supply-chain management: A case study on a supermarket chain in the UK. *Int. trans. in Ope.Res*, 11, 495-509.
- Georgantzias, N. C. 2003. Tourism dynamics: Cyprus' hotel value chain and productability. *System Dynamics Review*, 19(3), 175-212.
- Georgiadis, P. and Vlachos, D., 2004. The effect of environmental parameters on product recovery. *European Journal of Operational Research*, 157(2), 449-464.
- Grubbstrom, R. W. 1996. Stochastic properties of a production-inventory process with planned production using transform methodology. *Int. J. Production Economics*, 45(1-3), 407-419.
- Grubbstrom, R. W. 2000. Introducing capacity limitations into multi-level, multi-stage production-inventory systems applying the input-output/Laplace transform approach. *Int. J. Production research*, 38(17), 4227-4234.
- Higuchi, T., Troutt, M. D. 2004. Dynamic simulation of the supply chain for a short life cycle product—Lessons from the Tamagotchi case. *Computers, Operations Research*, 31(7), 1097-1114.
- Hilmola, O. P., Ojala L., Norrman, A. 2002. *The Elusive synergy of mergers: A system dynamics simulation of supply chains* [online]. Twelfth International Working Seminar on Production Economics, Igls/Innsbruck, Austria. Available from: [http://www.ipe.liu.se/rwg/igls/igls2002/volume1\\_2\\_3.htm](http://www.ipe.liu.se/rwg/igls/igls2002/volume1_2_3.htm). [Accessed 26 August 2007]
- Ho, D. C. K., Au, K. F. and Newton, E. 2002. Empirical research on supply chain management: a critical review and recommendations. *Int. J. Production research*, 40(17), 4415-4430.
- Holweg, M., Bicheno J. 2002. Supply chain simulation - a tool for education, enhancement and endeavour. *Int. J. Production Economics*, 78(2), 163-175.
- Ingalls, R. G. 1998. The value of simulation in modeling supply chains. *Proceedings of the 1998 Winter Simulation Conference*.
- Kleijnen, J., 2005. Supply chain simulation tools and techniques: a survey. *Int. J. Simulation, Process Modelling*, 1, 82-89.
- Lalwani, C. S., Disney, S. M. and Towill, D. R., 2006. Controllable, observable and stable state space representations of a generalized order-up-to policy. *Int. J. Production Economics*, 101(1), 172-184.
- Lee, Y. H., Cho, M. K., Kim, S. J. and Kim, Y. B. 2002. Supply chain simulation with discrete-continuous combined modeling. *Computer, Industrial Engineering*, 43(1-2), 375-392.
- Lyneis, J. M. 2000. System dynamics for market forecasting and structural analysis. *System Dynamics Review*, 16(1), 3-25.
- Marquez, A. C. 2004. Front-end, back-end and integration issues in virtual supply chain dynamics modeling. *Int. J. Logistics Systems and Management*, 1(1), 38-63.
- Marquez, A. C. and Blanchar, C., 2004. The procurement of strategic parts. Analysis of a portfolio of contracts with suppliers using a system dynamics simulation model. *Int. J. Production Economics*, 88(1), 29-49.
- Marquez, A. C., Bianchi, C. and Gupta, J. N. D., 2004. Operational and financial effectiveness of e-collaboration tools in supply chain integration. *European Journal of Operational Research*, 159(2), 348-363.
- Moon, S. A. and Kim, D. J., 2005. Systems thinking ability for supply chain management. *Supply Chain Management: An International Journal*, 10(5), 394-401.
- Nise, N. S., 1995. *Control Systems Engineering*. California: Benjamin/Cummings.
- Ovallea, O. R. and Marquez, A. C., 2003. Exploring the utilization of a CONWIP system for supply chain management: A comparison with fully integrated supply chains. *Int. J. Production Economics*, 83(2), 195-215.

- Paik, S. K., 2005. Factors affecting demand amplification in supply chains. *Sixteenth Annual Conference of POMS, Chicago, IL, April 29 - May 2, 2005*.
- Persson, F. and Olhager, J., 2002. Performance simulation of supply chain designs. *Int. J. Production Economics*, 77(3), 231-245.
- Power, D. J. and Sohal, A. S., 2001. Critical success factors in agile supply chain management. *Int. J. Physical Distribution , Logistics Management*, 31(4), 247-265.
- Rajagopalan, S. and Swaminathan, J. M., 2001. A coordinated production planning model with capacity expansion and inventory management. *Management Science*, 47(11), 1562-1580.
- Sterman, J. D., 2000. *Business dynamics, systems thinking and modeling for a complex world*. McGraw-Hill Higher Education.
- Terzi, S. and Cavalieri, S., 2004. Simulation in the supply chain context: a survey. *Computers in Industry*, 53(1), 3-16.
- Towill, D. R. 1982. Dynamic analysis of an inventory and order based production control system. *International Journal of Production Research*, 20(6), 671-687.
- Wikner, J., Towill, D. R. and Naim, M., 1991. Smoothing supply chain dynamics. *International Journal of Production Economics*, 22(3), 231-248.
- Wilson, M. C. 2002. *Operational Improvements in the Supply Chain: Who Benefits? Who Loses?* [online]. Available from: <http://www.systemdynamics.org/conf2002/papers/Wilso1.pdf> [Accessed 8 July 2006]

For Peer Review Only

Table 2. Previous work applying CT in the field of supply chain (Updated from Disney &amp; Towill, 2002) .

	Reference	Analysis techniques	Issues Considered	Supply Chain Decision Level		
				Strategic	Tactical	Operational
Pioneers	Simon(1952)	Differential equations and Laplace transforms	An inventory and order based production scheduling rule			X
	Tustin(1953)	Flow diagrams, Laplace and z-transforms	Economic systems			X
	Vassian(1955)	Difference equations and z-transforms	An order-and inventory-based production-scheduling algorithms			X
	Adelson(1966)	z-transforms	Second-order exponential smoothing forecasting algorithms within an inventory- and order-based production control system			X
	Deziel & Eilon(1967)	z-transforms, quadratic cost functions	A special conservative case of the APIOBPCS (Automatic Pipeline Inventory and Order Based Production Control System) structure where $T_i$ and $T_w$ always assume equal values $T_i$ : inverse of inventory based production control law gain $T_w$ : inverse of WIP based production control law gain			X
	Bessier & Zehna(1968)	z-transforms	Expend Vassian's model by using exponential smoothing as a specific forecasting technique			X
	Burns & Sivazlian(1978)	Signal flow graph, z-transforms	Order amplification of multi-echelon supply chain			X
1980's – 1990's	Towill(1982)	Block diagram and Laplace transforms	An inventory-and order-based production control system			X
	Popplewell & Bommey(1987)	Difference equations and z-transforms	A MRP system		X	
	John et al.(1994)	Block diagram and Laplace transforms	Incorporating a WIP controller into an inventory and order based production control system			X
	Grubstrom (1996)	Laplace transforms	Stochastic properties of a production – inventory process with planned production			X
	Grubstrom (1998)	NPV, Laplace transform and z-transform	MRP systems		X	
Contemporary	Grubstrom (2000)	Input-output analysis and Laplace transforms	Capacity-constrained multi-level, multi-stage production-inventory system		X	
	Dejonckheere et al. (2001)	Block diagram and z-transforms	The bullwhip performance of common forecasting mechanism			X
	Disney(2002)	Block diagram and z-transforms	Dynamic stability of a vendor managed inventory(VMI) supply chain		X	
	Dejonckheere et al.(2002)	Block diagram and Laplace transforms	The bullwhip generated by exponential smoothing algorithms			X
	Disney(2003)	Block diagram and z-transforms	Reducing the bullwhip and inventory variance produced by an ordering policy			X
	Dejonckheere et al.(2003)	Block diagram and z-transforms	A new replenishment rule to avoid bullwhip effect			X
	Disney(2004)	Block diagram and z-transforms	The golden ratio in production and inventory			X
	Dejonckheere et al.(2004)	Block diagram and z-transforms	The beneficial impact of information sharing on the bullwhip effect in multi-echelon supply chain	X		

	Lalwani et al.(2006)	State space model	Controllability, observability tests and stability analysis of a generalized order-up-to policy			X
--	----------------------	-------------------	---	--	--	---

Page 8: [2] Deleted

a

4/19/2008 8:18:00 PM

Table 3. 3 levels of the 8 factors.

Levels	P1	P2	P3	P4	P5	P6	P7	P8
1	3	12	10000	(0.5,0.5)	18	3	18	1
2	2	9	9000	(0.9,0.1)	12	2	12	2
3	1	6	8000	(0.1,0.9)	6	1	6	3

Table 4. Orthogonal forms.

Runs	Parameters							
	P1	P2	P3	P4	P5	P6	P7	P8
1	3	12	9000	(0.5,0.5)	18	3	18	1
2	3	12	9000	(0.5,0.5)	12	2	12	2
3	3	12	9000	(0.5,0.5)	6	1	6	3
4	3	9	10000	(0.9,0.1)	18	3	12	2
5	3	9	10000	(0.9,0.1)	12	2	6	3
6	3	9	10000	(0.9,0.1)	6	1	18	1
7	3	6	8000	(0.1,0.9)	18	3	6	3
8	3	6	8000	(0.1,0.9)	12	2	18	1
9	3	6	8000	(0.1,0.9)	6	1	12	2
10	2	12	10000	(0.1,0.9)	18	2	18	2
11	2	12	10000	(0.1,0.9)	12	1	12	3
12	2	12	10000	(0.1,0.9)	6	3	6	1
13	2	9	8000	(0.5,0.5)	18	2	12	3
14	2	9	8000	(0.5,0.5)	12	1	6	1
15	2	9	8000	(0.5,0.5)	6	3	18	2
16	2	6	9000	(0.9,0.1)	18	2	6	1
17	2	6	9000	(0.9,0.1)	12	1	18	2
18	2	6	9000	(0.9,0.1)	6	3	12	3
19	1	12	8000	(0.9,0.1)	18	1	18	3
20	1	12	8000	(0.9,0.1)	12	3	12	1
21	1	12	8000	(0.9,0.1)	6	2	6	2
22	1	9	9000	(0.1,0.9)	18	1	12	1
23	1	9	9000	(0.1,0.9)	12	3	6	2
24	1	9	9000	(0.1,0.9)	6	2	18	3
25	1	6	10000	(0.5,0.5)	18	1	6	2
26	1	6	10000	(0.5,0.5)	12	3	18	3
27	1	6	10000	(0.5,0.5)	6	2	12	1

Page 9: [3] Deleted

a

4/19/2008 8:28:00 PM

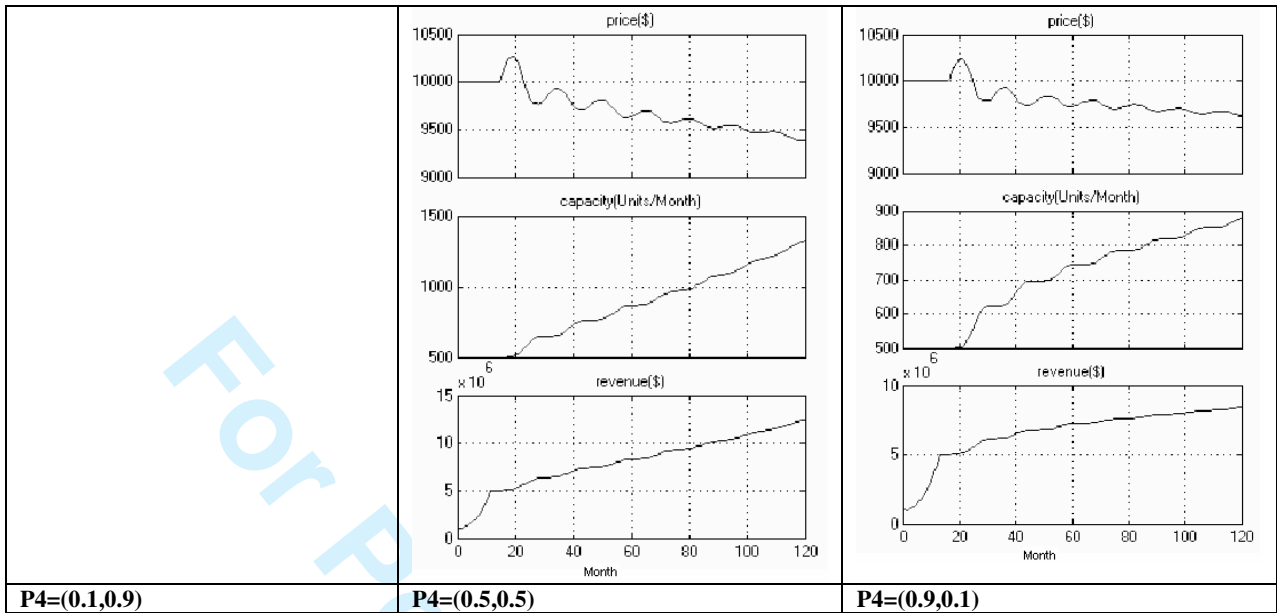

Figure 19. The results of Run12 with different values for P4.

## Capacity expansion decision in supply chains: A control theory application

X. Yuan<sup>a</sup> and J. Ashayeri<sup>b\*</sup>

<sup>a</sup> *Department of Industrial Engineering, Yanshan University, China;*

<sup>b</sup> *Department of Econometrics & Operations Research, Tilburg University, The Netherlands*

For Peer Review Only

---

\* Corresponding author. Email: j.ashayeri@uvt.nl

Table 1. Previous work applying SD in the field of supply chain.

Papers	1	2	3	4	5	6	7	8	9	Case study
Ashayeri et al., 1998						S		X		Edisico
Cakravastia & Diawati, 1999						M				Shipbuilding industry in Indonesia
Lyneis, 2000				X		M				Commercial jet aircraft industry
Baumgaertel et al., 2001	A					M				DaimlerChrysler Corporation
Akkermans, 2001	B									ASML
Holweg & Bicheno, 2002	B		X							Automotive steel supply chain
Wilson, 2002	B		X							
Hilmola, Ojala & Norrman, 2002	A									
Persson & Olhager, 2002	A					M				Mobile communications industry
Ovallea & Marquaz, 2003	B									
Akkermans & Vos, 2003			X			S				Telecommunication industry
Georgantzas, 2003				X		S				Crypus' Hotel
Marquez et al., 2004	B									
Marquez & Blanchar, 2004		X								
Georgiadis & Vlachos, 2004							X			
Higuchi & Troutt, 2004				X						Japanese pet-toy called Tamagotchi
Ge et al., 2004			X			S				A supermarket chain in UK
Akkermans & Dellaert, 2005									X	
Croson & Donohue, 2005			X							
Anderson et al., 2005			X			S				
Ashayeri & Lemmens, 2006				X		M			X	LG. Philips Displays Europe
<p>Legend:</p> <p>1. Supply chain Network structure design (<i>A-physical, B-policy</i>)</p> <p>2. Procurement management</p> <p>3. Bullwhip effect &amp; information sharing</p> <p>4. Forecasting</p> <p>5. Inventory &amp; production management</p> <p>6. Supply chain management environment (<i>M-manufacturing, S- service, including distribution &amp; transportation services</i>)</p> <p>7. Reverse Supply Chain (Close-loop supply chain)</p> <p>8. BPR(Business Process Re-engineering)</p> <p>9. Includes literature review</p>										

Table 2. Previous work applying CT in the field of supply chain (Updated from Disney &amp; Towill, 2002) .

	Reference	Analysis techniques	Issues Considered	Supply Chain Decision Level		
				Strategic	Tactical	Operational
Pioneers	Simon(1952)	Differential equations and Laplace transforms	An inventory and order based production scheduling rule			X
	Tustin(1953)	Flow diagrams, Laplace and z-transforms	Economic systems			X
	Vassian(1955)	Difference equations and z-transforms	An order-and inventory-based production-scheduling algorithms			X
	Adelson(1966)	z-transforms	Second-order exponential smoothing forecasting algorithms within an inventory- and order-based production control system			X
	Deziel & Eilon(1967)	z-transforms, quadratic cost functions	A special conservative case of the APIOBPCS (Automatic Pipeline Inventory and Order Based Production Control System) structure where $T_i$ and $T_w$ always assume equal values $T_i$ : inverse of inventory based production control law gain $T_w$ : inverse of WIP based production control law gain			X
	Bessier & Zehna(1968)	z-transforms	Expend Vassian's model by using exponential smoothing as a specific forecasting technique			X
	Burns & Sivazlian(1978)	Signal flow graph, z-transforms	Order amplification of multi-echelon supply chain			X
1980's – 1990's	Towill(1982)	Block diagram and Laplace transforms	An inventory-and order-based production control system			X
	Popplewell & Bommey(1987)	Difference equations and z-transforms	A MRP system		X	
	John et al.(1994)	Block diagram and Laplace transforms	Incorporating a WIP controller into an inventory and order based production control system			X
	Grubstrom (1996)	Laplace transforms	Stochastic properties of a production – inventory process with planned production			X
	Grubstrom (1998)	NPV, Laplace transform and z-transform	MRP systems		X	
Contemporary	Grubstrom (2000)	Input-output analysis and Laplace transforms	Capacity-constrained multi-level, multi-stage production-inventory system		X	
	Dejonckheere et al. (2001)	Block diagram and z-transforms	The bullwhip performance of common forecasting mechanism			X
	Disney(2002)	Block diagram and z-transforms	Dynamic stability of a vendor managed inventory(VMI) supply chain		X	
	Dejonckheere et al.(2002)	Block diagram and Laplace transforms	The bullwhip generated by exponential smoothing algorithms			X
	Disney(2003)	Block diagram and z-transforms	Reducing the bullwhip and inventory variance produced by an ordering policy			X
	Dejonckheere et al.(2003)	Block diagram and z-transforms	A new replenishment rule to avoid bullwhip effect			X
	Disney(2004)	Block diagram and z-transforms	The golden ratio in production and inventory			X
	Dejonckheere et al.(2004)	Block diagram and z-transforms	The beneficial impact of information sharing on the bullwhip effect in multi-echelon supply chain	X		
	Lalwani et al.(2006)	State space model	Controllability, observability tests and stability analysis of a generalized order-up-to policy			X

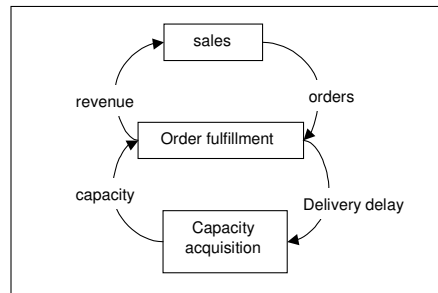

Figure 1. Sectors of the Serman's Model.

For Peer Review Only

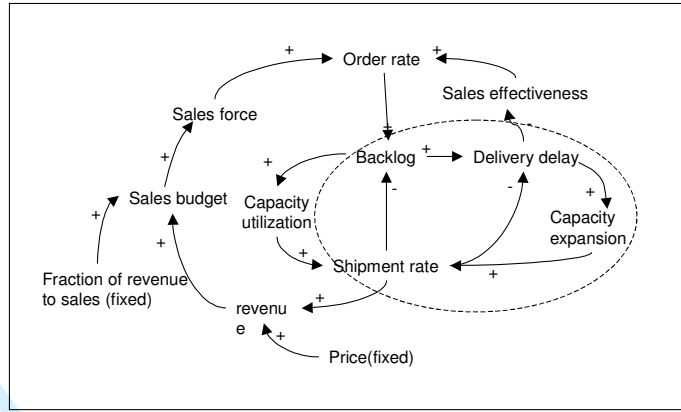

Figure 2. The original causal loop of Sterman's model.

For Peer Review Only

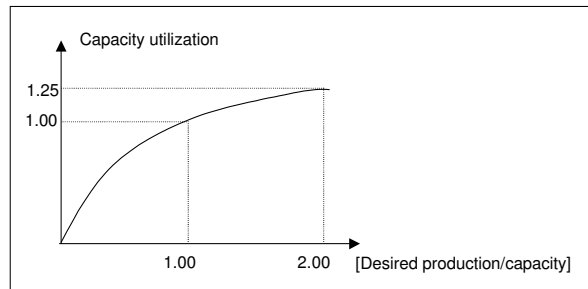

Figure 3. Capacity utilization function.

For Peer Review Only

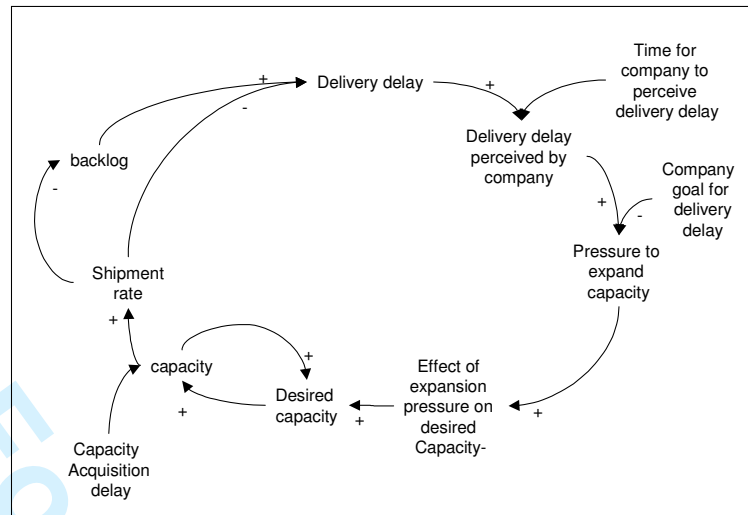

Figure 4. Details of capacity expansion causal loop (See dotted area in Figure 2).

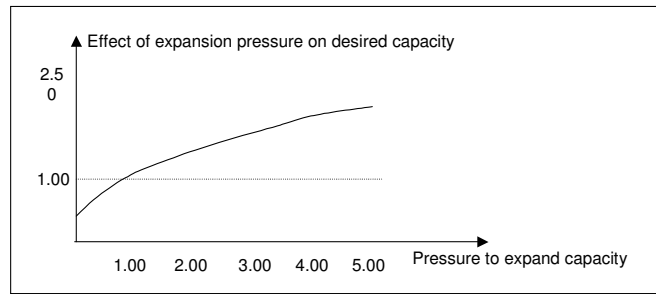

Figure 5. Effect of expansion pressure on desired capacity.

For Peer Review Only

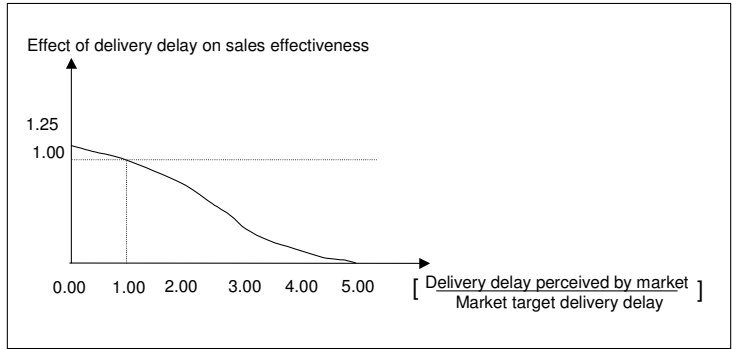

Figure 6. Effect of delivery delay on sales effectiveness.

For Peer Review Only

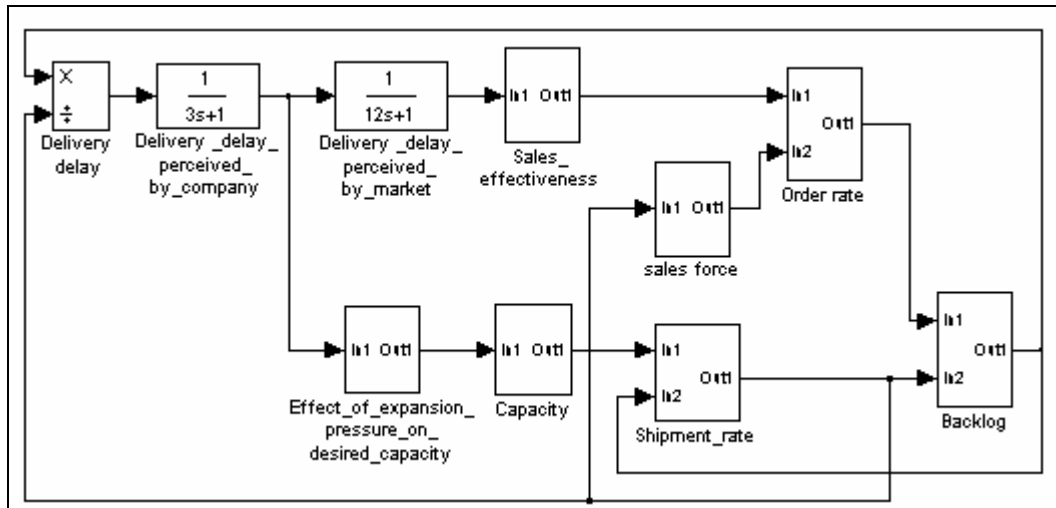

Figure 7. The block diagram of the whole system .

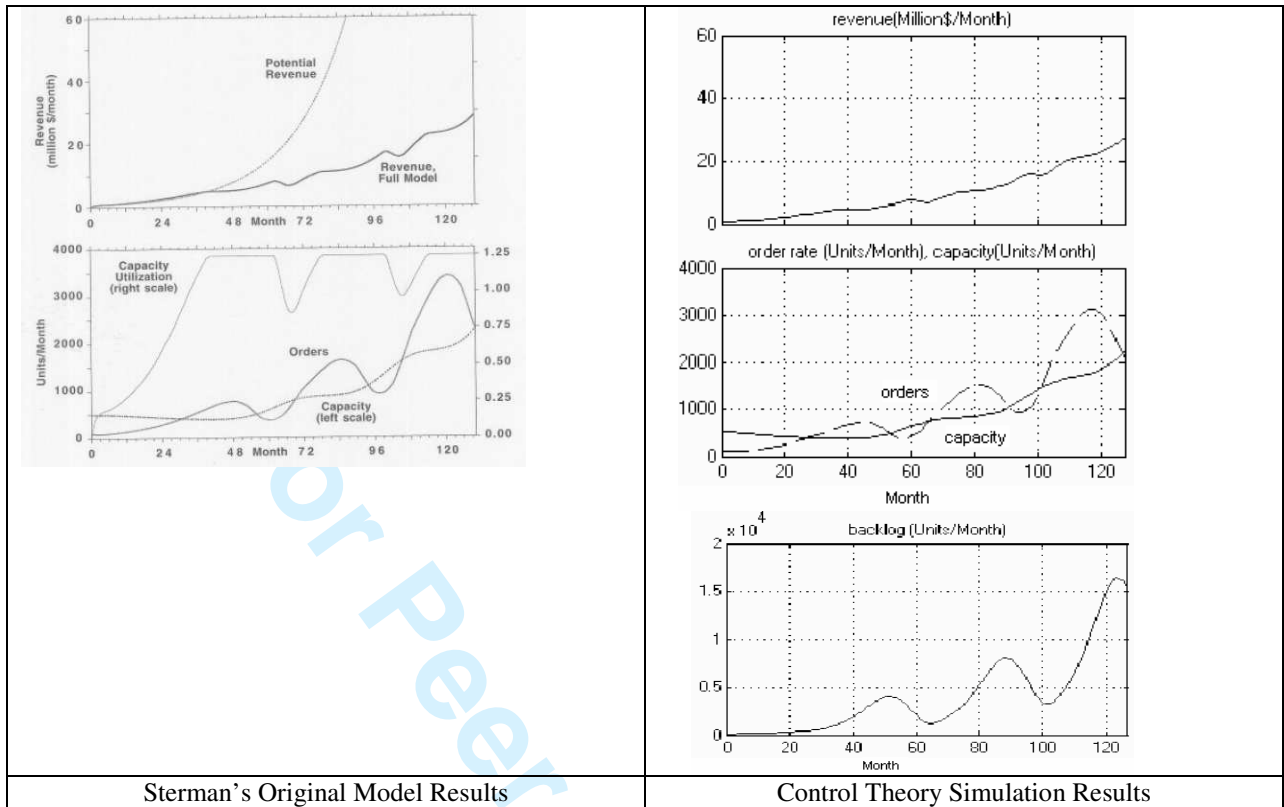

Figure 8. Simulation Model Behavior (system dynamics vs. control theory).

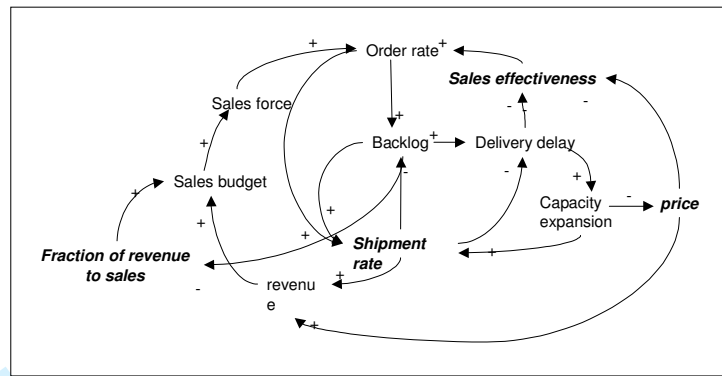

Figure 9. The general causal structure of improved model.

For Peer Review Only

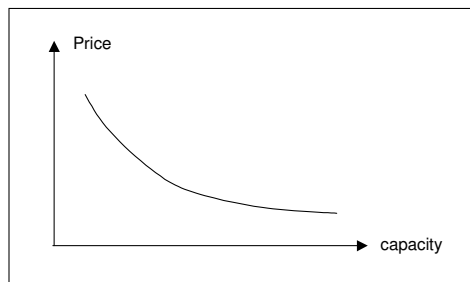

Figure 10. The relationship between price and capacity.

For Peer Review Only

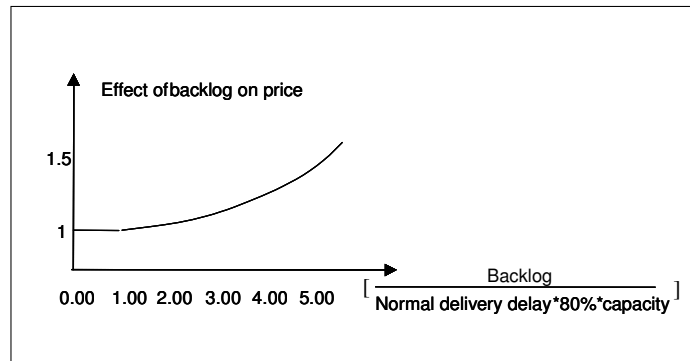

Figure 11. The effect of backlog on price.

For Peer Review Only

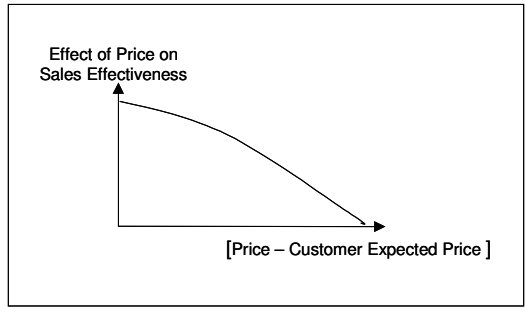

Figure 12. The effect of price on sales effectiveness.

For Peer Review Only

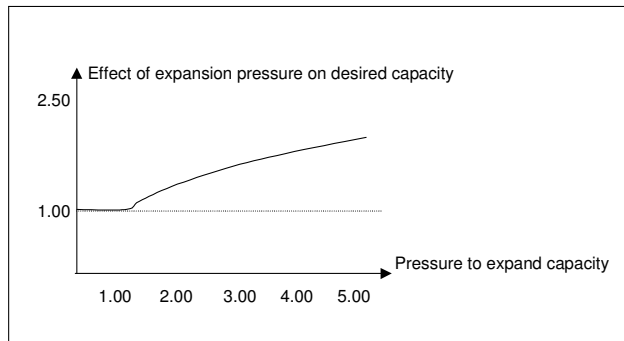

Figure 13. Effect of expansion pressure on desired capacity.

For Peer Review Only

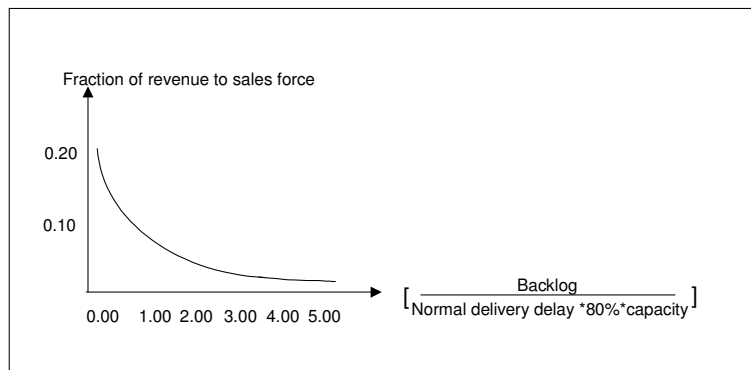

Figure 14. The effect of backlog on sales force investment.

For Peer Review Only

Table 3. 3 levels of the 8 factors.

Levels	P1	P2	P3	P4	P5	P6	P7	P8
1	3	12	10000	(0.5,0.5)	18	3	18	1
2	2	9	9000	(0.9,0.1)	12	2	12	2
3	1	6	8000	(0.1,0.9)	6	1	6	3

For Peer Review Only

Table 4. Orthogonal forms.

Runs	Parameters							
	P1	P2	P3	P4	P5	P6	P7	P8
1	3	12	9000	(0.5,0.5)	18	3	18	1
2	3	12	9000	(0.5,0.5)	12	2	12	2
3	3	12	9000	(0.5,0.5)	6	1	6	3
4	3	9	10000	(0.9,0.1)	18	3	12	2
5	3	9	10000	(0.9,0.1)	12	2	6	3
6	3	9	10000	(0.9,0.1)	6	1	18	1
7	3	6	8000	(0.1,0.9)	18	3	6	3
8	3	6	8000	(0.1,0.9)	12	2	18	1
9	3	6	8000	(0.1,0.9)	6	1	12	2
10	2	12	10000	(0.1,0.9)	18	2	18	2
11	2	12	10000	(0.1,0.9)	12	1	12	3
12	2	12	10000	(0.1,0.9)	6	3	6	1
13	2	9	8000	(0.5,0.5)	18	2	12	3
14	2	9	8000	(0.5,0.5)	12	1	6	1
15	2	9	8000	(0.5,0.5)	6	3	18	2
16	2	6	9000	(0.9,0.1)	18	2	6	1
17	2	6	9000	(0.9,0.1)	12	1	18	2
18	2	6	9000	(0.9,0.1)	6	3	12	3
19	1	12	8000	(0.9,0.1)	18	1	18	3
20	1	12	8000	(0.9,0.1)	12	3	12	1
21	1	12	8000	(0.9,0.1)	6	2	6	2
22	1	9	9000	(0.1,0.9)	18	1	12	1
23	1	9	9000	(0.1,0.9)	12	3	6	2
24	1	9	9000	(0.1,0.9)	6	2	18	3
25	1	6	10000	(0.5,0.5)	18	1	6	2
26	1	6	10000	(0.5,0.5)	12	3	18	3
27	1	6	10000	(0.5,0.5)	6	2	12	1

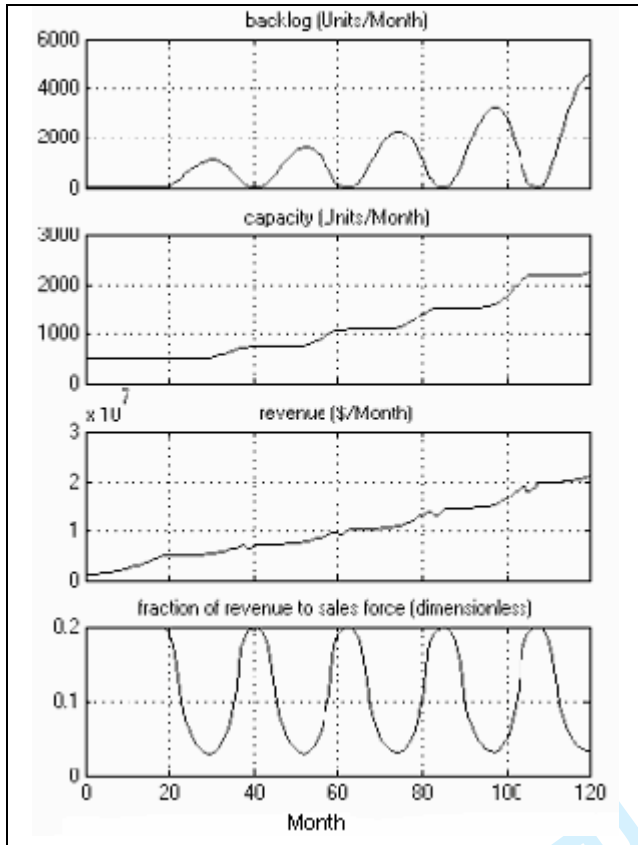

Figure 15. Run 6.

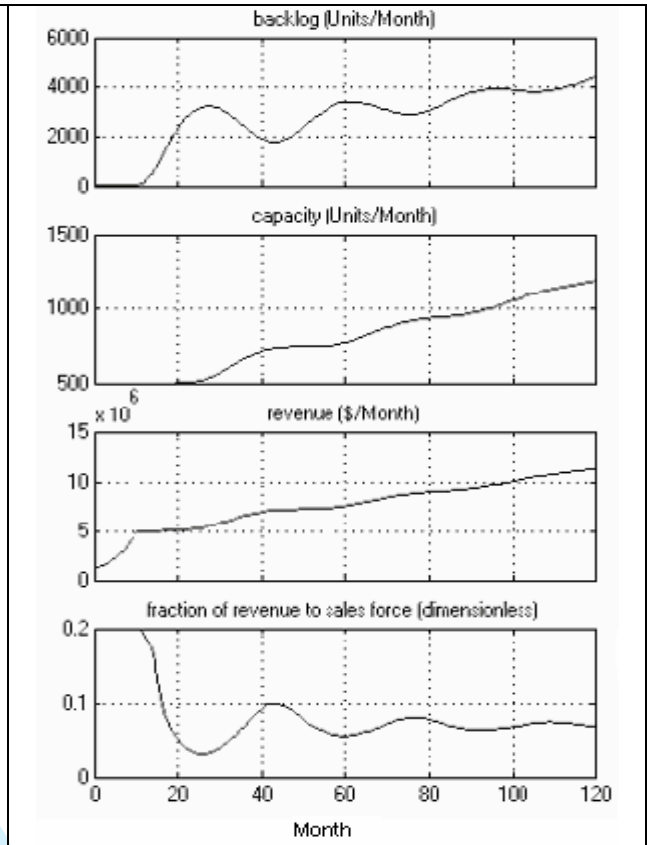

Figure 16. Run 11.

Review Only

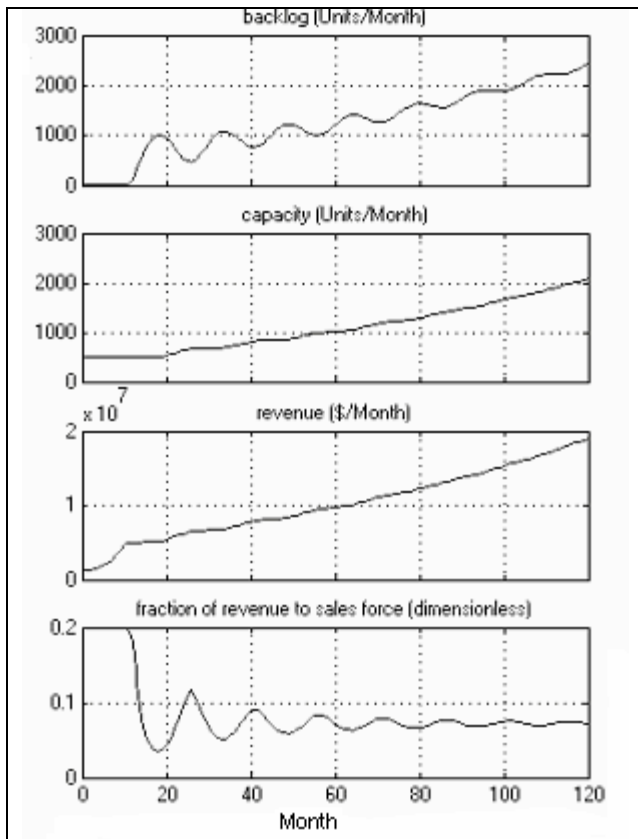

Figure 17. Run 12.

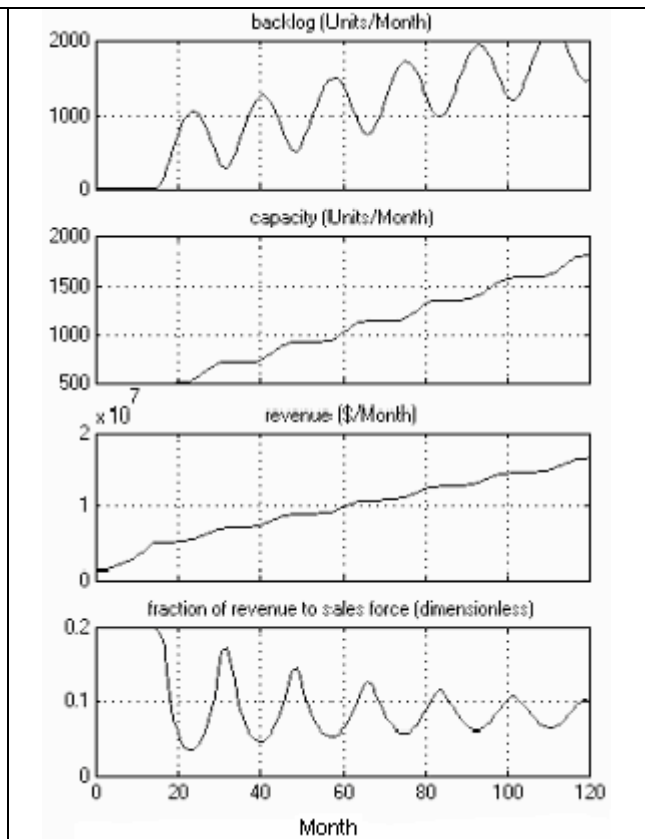

Figure 18. Run 27.

Review Only

Table 5. The NPV of outperformed runs.

Runs	Run 6	Run 11	Run 12	Run 27
NPV(\$)	628,157,289.79	507,831,026.68	653,074,686.81	620,756,836.28

For Peer Review Only

Table 6. The effect of each factor on NPV.

	Parameters	NPV(\$)	Difference in NPV (%)
P1	1	664,652,772.82	1.772858
	3	631,739,229.97	-3.26692
P2	9	652,513,732.78	-0.08589
	6	651,948,179.95	-0.17249
P3	9000	398,198,598.85	-39.0271
	8000	16,904,610.68	-97.4115
P4	(0.5,0.5)	533,830,868.18	-18.2588
	(0.9,0.1)	449,559,076.34	-31.1627
P5	18	437,529,662.61	-33.0047
	12	488,999,121.10	-25.1236
P6	2	708,487,333.90	8.484887
	1	772,439,375.18	18.27734
P7	18	731,980,743.02	12.08224
	12	711,959,081.38	9.016487
P8	2	623,233,553.67	-4.56933
	3	595,975,237.15	-8.74317
Original Run 12 (Parameters combination: 2,12,10000,(0.1,0.9),6,3,6,1)		653,074,686.81	

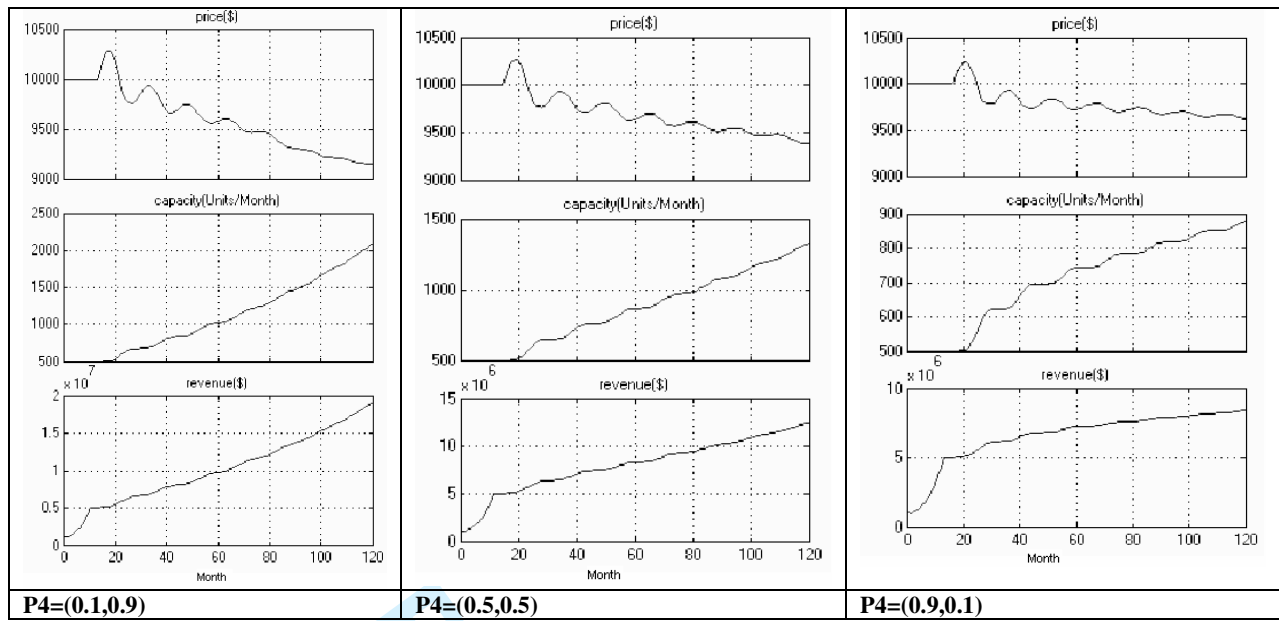

Figure 19. The results of Run12 with different values for P4.

Table 7. Range of each factor ( $\times 10^8$ ).

	P1	P2	P3	P4	P5	P6	P7	P8
$k_{j1}$	5.2	7.7	6.7	6.74	5.7	6.3	6.4	7.4
$k_{j2}$	7.1	6.6	9	7.3	6.2	6.5	6.6	5.9
$k_{j3}$	7.3	5.3	3.9	5.54	7.7	6.8	6.6	6.2
$R_j$	2.1	2.3	5.1	1.76	1.5	0.57	0.16	1.5

For Peer Review Only

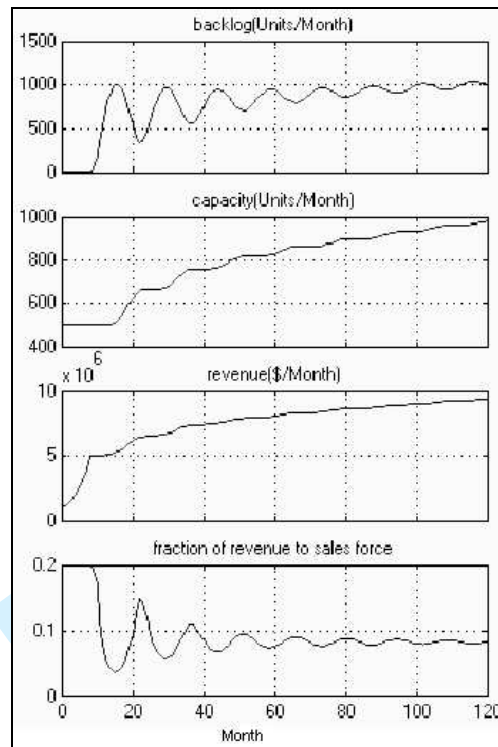

Figure 20. Range run results.