



HAL
open science

A novel approach to DFM in toolmaking: A case study

Joško Valentinčič, Daniel Brissaud, Mihael Junkar

► To cite this version:

Joško Valentinčič, Daniel Brissaud, Mihael Junkar. A novel approach to DFM in toolmaking: A case study. *International Journal of Computer Integrated Manufacturing*, 2006, 20 (01), pp.28-38. 10.1080/09511920600667333 . hal-00513373

HAL Id: hal-00513373

<https://hal.science/hal-00513373v1>

Submitted on 1 Sep 2010

HAL is a multi-disciplinary open access archive for the deposit and dissemination of scientific research documents, whether they are published or not. The documents may come from teaching and research institutions in France or abroad, or from public or private research centers.

L'archive ouverte pluridisciplinaire **HAL**, est destinée au dépôt et à la diffusion de documents scientifiques de niveau recherche, publiés ou non, émanant des établissements d'enseignement et de recherche français ou étrangers, des laboratoires publics ou privés.



A novel approach to DFM in toolmaking: A case study

Journal:	<i>International Journal of Computer Integrated Manufacturing</i>
Manuscript ID:	TCIM-2005-IJCIM-0017.R3
Manuscript Type:	Original Manuscript
Date Submitted by the Author:	20-Feb-2006
Complete List of Authors:	Valentinčič, Joško; University of Ljubljana, Faculty of Mechanical Engineering Brissaud, Daniel; University of Grenoble, INPG Laboratoires 3S Junkar, Mihael; University of Ljubljana, Faculty of Mechanical Engineering
Keywords:	PRODUCT DESIGN, ELECTRO-DISCHARGE MACHINING, EXPERT SYSTEMS, MACHINE SELECTION, MANUFACTURING ENGINEERING, DESIGN FOR MANUFACTURE
Keywords (user):	high speed milling (HSM), toolmaking



A novel approach to DFM in toolmaking: A case study

J. VALENTINČIČ†, D. BRISSAUD‡ AND M. JUNKAR†,

†University of Ljubljana, Faculty of Mechanical Engineering, Aškerčeva 6, SI-1000 Ljubljana, Slovenia, e-mail: lat@fs.uni-lj.si

‡Institut National Polytechnique de Grenoble, Laboratoire 3S, BP 53, 38041 Grenoble cedex 9, France, e-mail: daniel.brissaud@hmg.inpg.fr

Abstract

A novel approach to avoid the knowledge gap between design and production is presented in this paper. The main idea is to build a system in the form of a computer program whose core is the manufacturing expert systems to be used by the product designer. The system reveals critical features of the designed product from the manufacturing point of view and points them out to the product designer. The product designer can decide whether to change the critical part of the product or not. The system presented in this paper is prepared for the toolmaking, where a lot of relatively cheap products are made by one relatively expensive tool. Since the shape of the cavity in the tool is the negative shape of the product, small changes in the product design can significantly reduce the manufacturing costs of the tool.

Key words: *design for manufacture (DFM); electrical discharge machining (EDM); high speed milling (HSM); expert system; process selection; toolmaking*

1. Introduction

Ulrich and Eppinger (1995) discovered that from hundreds of product concepts, only five up to twenty will merit serious consideration. According to Allada and Anand (1995) it is due either to an inadequate exploration of all feasible alternative concepts or to an ineffective integration of the product design concepts with evaluation criteria such as ease of manufacture and production costs.

Design for manufacture (DFM) philosophy is characterized by a simultaneous design of a product and its manufacturing process in order to achieve the best outcome and consequently optimise the overall costs. The degree of integration between the product and the process is measured by *manufacturability* which implies easy production and can be approximated by the capacity to achieve the desired quality and productivity while optimising costs.

A lot of work has been done within the last ten years in the field of design, driven by manufacturing issues of tools. DFM needs a lot of *expert knowledge of the manufacturing process itself*. For example, knowledge on the wear process of an electrode machining of a tool is proposed by Mohri et al. (1995), a process planning system for sinking electrical discharge machining (EDM) operations is proposed by

Lauwers and Kruth (1994) and knowledge about comparison and selection of competitive technologies, such as EDM and high speed milling (HSM) in tool manufacturing, is proposed by Alam et al. (2002). The second part of the last work deals with the basic DFM techniques such as rules advising the designer, guidelines assisting him throughout methodology, simulation software to detect problems in shape, quality or productivity and cost calculation software to control manufacturing costs. An overview of this field is given in Boothroyd and Dewhurst (1994, 1998).

For DFM implementation, Lee et al. (1997, 1998) suggest the *rationalization of the design process*. Chin and Wong (1999) proposed a system for rationalization of the design process of tools for plastic injection and Ding et al. (2000) for the EDM electrode design process.

What becomes the most significant topic in DFM system is *the management of the whole body of knowledge and data*. Chen and Hsiao (1997) proposed a collaborative data management system. Young et al. (1999) proposed a system providing high-quality information on basis of which designers can make their decisions on-line. Lee et al. (1997, 1998) proposed to embody information into knowledge bases and expert systems.

The last portion of knowledge needed in a DFM system is related to the *design methodology*. Boothroyd and Dewhurst (1994) and Huang and Mak (1998) propose classical methodology based on seven steps: (1) product analysis to collect and clarify information, (2) manufacturing process analysis concerned with the collection, processing and reporting of process-specific and resource-specific data, (3) measurement of the interactions between product and process information in terms of the relevant performance indicators, (4) highlighting of problems, (5) diagnosis for effects and causes, (6) advices in redesign, and (7) prioritising changes in the design procedure, if necessary.

In this paper, an integrating system for the design of the product and its simultaneous adaptation to the tool manufacturing is proposed. The system is to be used by product designers. Based on the main principles of DFM techniques, its originality comes from both the adaptation methodology and the implementation of professional knowledge. The Design Adaptation System for Machining in Toolmaking (DASMT) aims to address the embodiment and detail design phases of the product definition, as well as the conceptual design phase of the die definition at an early stage, when there is still time to make significant changes. This methodology is extremely useful, as it enables evaluation and optimisation of the design and avoids designers' time-consuming iterations.

The paper is organised as follows: The techniques of DFM were introduced in the first section. In the second section, the novel approach to DFM, which is focused in toolmaking, is presented. A detailed insight into the DASMT is given in the third section. A case study is given in the fourth section. Finally, the conclusions are drawn in the last section.

2. Methodology of the design adaptation system for machining in toolmaking

In the batch production, the relation between the design and manufacturing of the product is very complex since the tool for batch production is required and it has to be produced beforehand. The relations between the design and manufacturing become even more complex if the tool is not produced in the same company than the product (e.g. casing, plastic bottle)

In general, tool consists of one or more cavities. The shape of the cavity depends on the product design, and is usually extremely complex. Therefore it is important to decompose it into individual *features* regarding the requested shape, tolerances and surface roughness of the cavity. A manufacturing feature can be defined as a geometrical form of the workpiece to which manufacturing properties are associated and for which a manufacturing process is known. *In the case of EDM process, a feature is a part of the tool which can be machined by an electrode or a set of electrodes for rough and fine machining on a given EDM machine.*

EDM and HSM are the two manufacturing processes generally applied for machining of tool features. In most cases, both processes are applied sequentially for the production of the given tool. When EDM is selected, the electrode will be made which shape will be transferred into the workpiece, i.e. tool. The entire design process consists of the product design, the tool design and the electrode design. The tool has to be designed according to the product design by taking into account all properties of the product manufacturing process (forging, moulding, etc.) as well as the tool manufacturing processes (EDM, HSM). The electrode itself is defined by the tool features and is generally machined by wire-EDM, milling process, etc. Consequently, the entire production process includes the simultaneous design of the product, the tool(s), the electrode(s) and the associated manufacturing processes. All these activities should be done simultaneously but unfortunately in practice this is still impossible.

As mentioned before, the DASMT aims to adapt the product design to the tool manufacturing. The system which presents the toolmaking knowledge on the design level was developed by the integration of results from the literature and our knowledge. If the product design is denoted as \mathbf{D}^* and the tool manufacturing is denoted as \mathbf{M} , then:

$$\mathbf{M}=F(\mathbf{D}^*). \quad (1)$$

The product design and the tool manufacturing are described by various attributes, $\mathbf{D}^*=(\mathbf{d}_1^*,\mathbf{d}_2^*,\dots,\mathbf{d}_p^*,\dots,\mathbf{d}_p^*)$ and $\mathbf{M}=(\mathbf{m}_1,\mathbf{m}_2,\dots,\mathbf{m}_q,\dots,\mathbf{m}_Q)$, respectively. Function F embraces several functions which describe the relations between the attributes \mathbf{d}_p^* and \mathbf{m}_q . The adaptation deal with the inverse problem of deriving the design attributes \mathbf{D}^* from manufacturing attributes \mathbf{M} :

$$\mathbf{D}^*=F^{-1}(\mathbf{M}). \quad (2)$$

For each manufacturing attribute \mathbf{m}_q , it is necessary to define all mapping functions f_r with other manufacturing attributes $\mathbf{m}_{q'}$ and design attributes \mathbf{d}_p^* :

$$\mathbf{m}_q=f_r(\mathbf{d}_p^*,\mathbf{m}_{q'}): p \in \{1,2,\dots,P\}; q,q' \in \{1,2,\dots,Q\}, q \neq q'; r \in \{1,2,\dots,R\}. \quad (3)$$

The mappings from the design to the process planning level are better defined than vice versa. Thus, function F is easier to describe than the inverse function F^{-1} which is needed for the adaptation of the product design to the manufacturing of the tool. In DASMT, function F is represented in the form of computer algorithms which are assembled into three expert subsystems (modules) for each field as described later. The inverse function F^{-1} is obtained by including the product designer into the interaction between the three expert systems.

3. The Design adaptation system for machining in toolmaking

The expert systems included into the design adaptation system for machining in toolmaking (DASMT) provide the manufacturing knowledge in the form of critical information of the product (critical from the manufacturing point of view) to the designer. The decision about the design adaptation is only dependant on the designer by considering the demands of the product and the demands of the tool. The latter are presented to the designer by DASMT in the form of the critical parts of the product design from the tool manufacturing point of view. Thus, the basic idea of the system is to determine the critical design attributes; the determination is based on the network of dependencies between the design and the manufacturing attributes.

First, the dividing plane of the tool is defined by the DASMT and both parts of the tool are segmented into several features according to the design data of the product. Further on, the appropriate machining process is defined for every feature and critical parts of the features are revealed. If the demands of the product enable the adaptation of the critical parts, the designer adapts those parts in order to ease the tool manufacturing. Once the designer changes the design configurations and the attributes, the DASMT makes changes of the tool design and adapts the machining processes and its machining parameters to the new, altered design. Adaptations are driven by improvements of product and tool definitions, minimising the overall production costs and maximising productivity. Substantial increases in the ease of tool production can be achieved by slight alterations of critical product design attributes which should however not deteriorate its functionality.

The general concept of DASMT is presented in figure 1. The upper part of the figure presents the information flow between the product designer, the tool engineer and the operator of the machine who actually makes the tool. The lower part of the given figure shows the information flow between the designer and the modules of DASMT. These are: Module for Tool Segmentation and Selection of the Machining Process (MSaSMP), Design Adaptation Module for EDM (DAM-EDM) and Design Adaptation Module for HSM (DAM-HSM).

[insert figure 1 about here]

The product design attributes \mathbf{D}^* are introduced to the MSaSMP as shown in figure 1. The module defines the dividing plane and segments each part of the tool into several features and for each feature it determines the appropriate machining process. Further on, a set of tool design attributes \mathbf{D} is generated. The relation

between \mathbf{D}^* and \mathbf{D} is relatively simple since the tool has a negative shape of the product. The product dimensions differ from the tool dimensions for the contraction of the product material due to the temperature dilatation. Nardin (1999) built the MSaSMP module and up to now it has been working as an autonomous system.

The machining process is selected for each feature described by tool design attributes \mathbf{D} : the selection is made between EDM and HSM. According to this selection, each tool feature is presented to the appropriate design adaptation module: DAS-EDM or DAS-HSM in order to be examined from the manufacturing point of view. In this process, the critical design attributes \mathbf{D}_{cr} which are the most problematic from the manufacturing point of view, are established. They are identical to the critical product design attributes \mathbf{D}_{cr}^* that are presented to the designer. The designer then tries to adapt the design focusing on the given critical product design attributes. The system is interactive: after every product design adaptation, the new critical product design attributes are calculated.

3.1 Modules of the DASMT

The whole DASMT consists of three modules. Nardin (1999) presented MSaSMP and thus it will not be presented in detail here. Since both other modules, namely DAM-EDM and DAM-HSM, have not been presented in the literature yet, they are briefly presented here.

DAM-EDM and DAM-HSM can also work as an autonomous system which solves specific problems such as tool design adaptation to the specific machining process. Such an autonomous system is to be used by the tool designer who makes tool design for the given product and optimizes the shape of tool features according to the selected machining process of the given feature. Since the tool designer is not familiar with the demands of the product, such optimization also requires the presence of the product designer.

The conceptual scheme is equal for both modules and is shown in figure 2. Design attributes of the tool are established by MSaSMP, where also the most appropriate machining process is selected for each feature of the tool and the attributes are sent to the corresponding module; the design attributes of the feature to be machined by EDM are sent to the DAM-EDM whereas the design attributes machined by HSM are sent to the DAM-HSM.

[insert figure 2 about here]

The kernel of DAM-EDM and DAM-HSM is an expert system which at first chooses an appropriate machine for the machining of the feature. The content of the machines' database depends on the machines which are available to the toolmaking company which will produce the tool. Each machine has its own machining parameters database. The EDM machines use different machining parameters to achieve the same machining results. On the other hand, not all of the HSM machines have the same performances and the same tools available in the given toolmaking company. Thus, the dashed line in figure 2 indicates that the machining parameters database depends on the selected machine. After the machine selection, the machining parameters are determined by the expert system.

Algorithms of the machine selection and the machining parameters selection strongly depend on the selected machining process. Further on, the DAM-EDM will be described.

3.2 The DAM-EDM

The description of the tool design has been formalised as design attributes which altogether describe the tool. According to the industrial as well as our own experience, ten tool design attributes have been selected to define the design to be adapted for the ease of EDM machining of the tool. The design attributes are in general vectors and noted as \mathbf{d}_i . Two attributes characterise the whole tool: the maximum dimensions of the tool (x, y, z) \mathbf{d}_1 and tool material \mathbf{d}_4 . Each tool feature is characterised by 7 attributes: shape of the feature \mathbf{d}_2 , tolerances of dimensions, shapes and position of the feature \mathbf{d}_3 , eroding surface size \mathbf{d}_5 , machining depth \mathbf{d}_6 , feature surface roughness \mathbf{d}_7 , allowed depth of the heat affected zone (HAZ) \mathbf{d}_8 , edge radii and depths that radii occur \mathbf{d}_9 and inclination of flank surfaces \mathbf{d}_{10} .

To describe the characteristics of EDM machines and their performances, two databases have been built. The first database consists of the EDM machines data which are available in the given toolmaking company. The important data are: the machine working area in x, y, z axes \mathbf{m}_1 , the list of the axes that can operate on the particular machine \mathbf{m}_2 , and the precision of the machine in each axis \mathbf{m}_3 .

The second database consists of machining parameters and their performances. A group of machining parameters, denoted as \mathbf{m}_5 , includes open-circuit voltage, electric current amplitude and pulse-on time. Each group of parameters is limited by the smallest eroding surface size that can be machined by the given values of the machining parameters. For each group of the machining parameters, the following performances are given: the relative corner wear of the electrode, the achieved surface roughness, the achieved depth of the HAZ and the requested machining allowance which should be taken into account when changing from rough to fine machining. This database is a direct copy of the technological tables, given by the machine manufacturer as assistance to the machine operator or as part of the machine controller. For the sake of completeness, the electrode material \mathbf{m}_4 and the required number of electrodes for machining of the given feature of the tool \mathbf{m}_6 are mentioned here.

Mappings from the tool design to the tool manufacturing are presented in figure 3. Some of the mappings are very simple, e.g. the machine working area, which is selected for the machining of the given tool, must be larger than the size of the tool. A more sophisticated problem is to determine the suitable machining parameters. It can be solved by the computer algorithm which takes into account the selected EDM machine (database of the machining parameters and process performances – mapping f_7) and the design attributes of the given feature (mapping f_5).

[insert figure 3 about here]

Since the purpose of this paper is to present the novel approach to manufacturing knowledge presentation on the design level, the algorithms for mapping from design to manufacturing level will not be described here but are instead

presented by Valentinčič (2000a). From figure 3, one can observe that the mappings are made from design to manufacturing level (function F). The inverse function F^{-1} is obtained through the user of DASMT, i.e. the product designer.

5. Case study

The following case study will show the procedure of the design adaptation of the feature which is to be machined by the EDM process. The software is written in Java language and is available on the Internet (Valentinčič et al. 2000b).

The drawing of the tool for producing chassis of the lock is given in figure 4. The dimensions and appurtenant tolerances, important for selection of the machining parameters, are encircled.

[insert figure 4 about here]

Tolerances are marked by letters a , b and d and are numbered as well. Letter a stands for the dimensional tolerances in the feature that are parallel to the machining direction. Letter b stands for the dimensional tolerances outside of the feature that are parallel to the machining direction (in our case, it gives the position of the feature on the tool). Letter d stands for the dimensional tolerances outside of the feature that are perpendicular to the machining direction (in our case, these tolerances are various depths in the feature). In equation 3 all of the tolerances are denoted as vector \mathbf{d}_3 .

In figure 4, each rounding is encircled as stated before. On the side of the circle, the depth in mm is written, measured from top of the feature to bottom of the roundness, e.g. roundness R 4.53 starts at depth 8.95 and ends at depth 13.08, thus its depth is $h=13.08$. In equation 3 all of the edge radii and the associated depths are denoted as vector \mathbf{d}_9 .

To perform the design adaptation, the feature is parametrically presented to the software by the design attributes \mathbf{D} . The design attributes are divided into two groups as shown in figure 3, namely the design attributes related to the machine selection (\mathbf{d}_1 to \mathbf{d}_3) and the design attributes related to the machining parameters selection (\mathbf{d}_4 to \mathbf{d}_{10}). Consequently, the design adaptation is performed in two stages.

5.1 Stage 1

In this stage, the available EDM machines have to be described by manufacturing attributes: working area of the machine \mathbf{m}_1 , machining axes of the machine \mathbf{m}_2 and machining precision of the machine \mathbf{m}_3 in x - y plane and z direction (figure 5). In our case there are four EDM machines available—in the workshop or outsourced. The machines are listed by priority: one can notice that *machine A* is the most simple machine which can only machine in z axis and as far as the achieved precision is concerned, it is relatively low. It is the least occupied machine, thus it has the highest priority (1). On the other hand, the *machine D* is the best machine available; it is the most precise and has four integrated axes. It is the most occupied machine, thus it has the lowest priority (4).

[insert figure 5 about here]

The size of the tool d_1 and shape of the feature d_2 are given on the sheet named Tool shape. This sheet is not shown in this paper since these attributes are not playing the role in the design adaptation in this case study. The tolerances d_3 are given on two sheets: tolerances marked by letter a and b on figure 4 are given on the sheet named Tolerances 1/2 (figure 6) and tolerances marked by letter d on figure 4 are given on the sheet named Tolerances 2/2 (figure 7).

[insert figure 6 about here]

[insert figure 7 about here]

In such a way, the tool feature is described to the DAM-EDM and the *machine C* for machining the given feature on the tool is selected. The *machine C* is marked by sign “<<” on figure 5. The design attribute which is the reason for the selection of the machine with priority 3, is the *critical design attribute*. In our case, it is the dimensional tolerance of the feature position parallel to the machining direction, marked by $b1$ in figure 4. The critical design attribute is marked with the sign “<<” in figure 6.

It is a designer’s task to decide whether to enlarge the given tolerance, e.g. from 0.01 to 0.02 mm. Since the tool is made out of two parts and the dividing plane should not be visible on the product, the position of the feature has to be made in the given tolerance. Enlargement of the tolerance is not acceptable and the feature has to be made by the selected machine.

5.2 Stage 2

At this stage, the design attributes specific for the feature are adapted for the machining by the selected machine. The design attributes of the feature are parametrically presented to the DAM-EDM system on the last sheet named Feature adaptation.

The selected machine defines the available machining parameters and their process performances which are assembled on the sheet named Machining parameters—this sheet is not enclosed in this paper, but one can check it by using the software published on the Internet (Valentinčič et al. 2000b).

The following design attributes describe the feature to be adapted to the EDM machining and are entered on the Feature adaptation sheet (figure 8). Tool material d_4 is in our case steel, eroding surface size d_5 is approximately 1000 mm², feature depth d_7 is the deepest point of the feature measured from the starting point of machining (in our case the feature depth equals 13.08 mm). The required depth of the HAZ is not specified.

The machining procedure of one axis machining, i.e. the machine allows machining only in one, usually vertical axis, differs from the machining procedure of multi-axes machining, also called planetary or orbital machining. In the case of one-

axis machining of vertical planes which are inclined for more than 5 degrees measured from the machining direction, the depth of machining where machining parameters have to be changed from rough towards fine machining depends on the inclination of the planes \mathbf{d}_{10} . In the given example (Figure 4) all the planes that are inclined for more than 5 degrees form the machining direction and are perpendicular to the machining direction. Thus, the value 90 degrees is given to the DAM-EDM as shown in figure 8. Last but not least, the edge radii and the associate depths (both denoted as vector \mathbf{d}_9) are entered to the DAM-EDM.

The button Machining parameters selection starts the EDM expert system which determines the technological parameters: chooses the electrode material \mathbf{m}_4 , selects the proper machining parameters \mathbf{m}_5 , calculates the depths at which the machining parameters have to be changed, calculates the required number of the electrodes \mathbf{m}_6 , and finds out the necessity of polishing as the last machining operation. In our case, the following technological parameters are selected for machining the given feature: copper as the electrode material, 2 electrodes are required, rough (starting) machining parameters marked by number 7 and finishing machining parameters marked by number 3 are selected. Polishing is not required.

The critical design attributes, which are defining the values of the technological parameters given above, are marked by sign “<<” on the Feature adaptation sheet (figure 8). They are: the feature depth \mathbf{d}_6 , surface roughness of the feature \mathbf{d}_7 and roundness and depth 3 which is the element of the vector \mathbf{d}_9 .

[insert figure 8 about here]

It is a designer's choice which of the critical design parameters can be adapted for easier feature machining: The depth of the feature cannot be changed but the surface roughness of the feature and some of the edge radii can be changed while the associate depths cannot be changed.

After some iterations of adapting the design attributes, the number of electrodes is reduced to 1 and the finishing machining parameters are changed from number 3 to number 4. To achieve this, the edge radii and the surface roughness have to be changed as shown in figure 9. By changing the finishing machining parameters and enlarging the radii, the machining time and machining costs are significantly reduced.

[insert figure 9 about here]

6. Conclusions

In this paper the DASMT system has been described. It belongs to the group of DFM systems but it differs from other DFM systems as it leaves the best design solutions to the designer himself who has the best knowledge about the demands of the product characteristics. Furthermore, the designers' knowledge also incorporates the knowledge about aesthetics, ergonomics, etc. In such a way the designers' creativity is fully supported: instead of leading the designer through the process of design, the

DASMT system only points out the weak parts of the product design from the manufacturing point of view and leaves full freedom to the designer to adapt it. The weak points of the design are revealed by expert systems DAM-EDM and DAM-HSM.

The design adaptation for the ease of manufacture is a complex task, particularly in toolmaking industry where plenty of decisions have to be coordinated. Thus, the modular approach to the system building is very suitable. Up to now, modules of the DASMT system have been developed separately, and each module works autonomously. Nardin (1999) presented the MSaSMP module while the DAM-EDM module with a case study has been presented in this paper. The case study clearly shows that the designers' creativity is not limited by the DAM-EDM system and that small changes of the design attributes can significantly improve the machinability of the tool.

The future work will be focused on the development of the DAM-HSM module for adapting features that will be machined by HSM. The DAM-HSM will follow the same philosophy as the DAM-EDM. Later, all three modules will be included into the general system—DASMT whose functionality is described in this paper.

References

- Ulrich, K.T., and Eppinger, S.D., 1995, *Product Design and Development*, McGraw-Hill, New York.
- Allada V., and Anand, S., 1995, Feature base modelling approaches for integrated manufacturing: state-of-the-art survey and future research directions, *International Journal of Computer Integrated Manufacturing*, 8/6, pp. 411-441.
- Mohri N., Suzuki, M., Furuya, M., and Saito, N., 1995, Electrode wear process in electrical discharge machining, *Annals of the CIRP*, **44**(1), pp. 165-168.
- Lauwers B., and Kruth, J.P., 1994, Computer aided process planning for EDM operations, *Journal of Manufacturing Systems*, **13**, pp. 313-322.
- Alam, M. R., Lee, K. S., Rahman, M., and Sankaran, K. S., 2002, Decision algorithm for selection of high-speed machining, EDM or a combination for the manufacture of injection moulds, *International Journal of Production Research*, **40**(4), pp. 845-872.
- Boothroyd G., and Dewhurst, P., 1994 *Product Design for Manufacture and Assembly*, Marcel Dekker Inc.
- Boothroyd Dewhurst Inc. 1998, BDI, software for world class product design, <http://www.dfma.com/software/index.html>
- Lee R.S., Chen, Y.M., and Lee, C.Z., 1997, Development of a concurrent mold design system: a knowledge-based approach, *Computer Integrated Manufacturing Systems*, **10**(4), pp. 287-307.

- Lee R.S., Chen, Y.M., Hsin, Y.C., and Kuo, M.D., 1998, A framework of a concurrent process planning system for mold manufacturing, *Computer Integrated Manufacturing Systems*, **11**(3), pp. 171-190.
- Chin, K.S., and Wong T. N., 1999, Integrated product concepts development and evaluation, *International Journal of Computer Integrated Manufacturing*, **12**(2), pp. 179-190.
- Ding, X.M., Fuh, J.Y.H., Lee, K.S., Zhang, Y.F., and Nee, A.Y.C., 2000, A computer-aided EDM electrode design system for mold manufacturing, *International Journal of Production Research*, **38**(13), pp. 3079-3092.
- Chen, Y.M., and Hsiao, Y.T., 1997, A collaborative data management framework for concurrent product and process development, *International Journal of Computer Integrated Manufacturing*, **10**(6), pp. 446-469.
- Young, R.I., Canciglieri, O., and Costa, C.A., 1999, Manufacturing Information Interactions in Data Model Driven design, *Journal of Engineering manufacture*, **213**(5), pp. 527-532.
- Huang, G.Q., Mak, K.L., 1998, The DFX shell: A generic applying 'Design for X' (DFX) framework for tools, *International Journal of Computer Integrated Manufacturing*, **11**(6), pp. 475-484.
- Valentinčič, J. 2000a, Adaptation of the product to electrical discharge machining in toolmaking, Faculty of mechanical engineering, Ljubljana, Master's thesis (selected chapters).
- Valentinčič, J., Orbanić, H., and Zlobec, S., 2000b, <http://www.fs.uni-lj.si/lat/dfm>
- Nardin, B. 1999, Načrtovanje preoblikovalnih tehnologij in orodij v majhnih in srednje velikih podjetjih, Faculty of mechanical engineering, Ljubljana, Master's thesis.

List of figure captions

Figure 1: Scheme of the DASMT

Figure 2: Conceptual scheme of DAM-EDM and DAM-HSM

Figure 3: Mappings of the design attributes of the tool to the manufacturing attributes of the tool.

Figure 4: Drawing of the lock - a case study

Figure 5: A database of available EDM machines

Figure 6: Required tolerances (1/2) of the feature to be machined by the EDM

Figure 7: Required tolerances (2/2) of the feature to be machined by the EDM

Figure 8: Feature adaptation for the ease of manufacturing - design and manufacturing parameters *before* the adaptation.

Figure 9: Feature adaptation for the ease of manufacturing - design and manufacturing parameters *after* the adaptation.

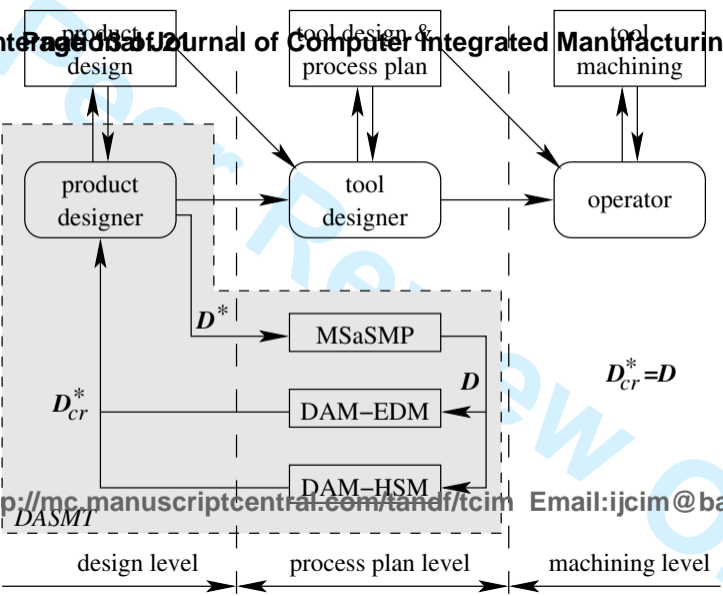

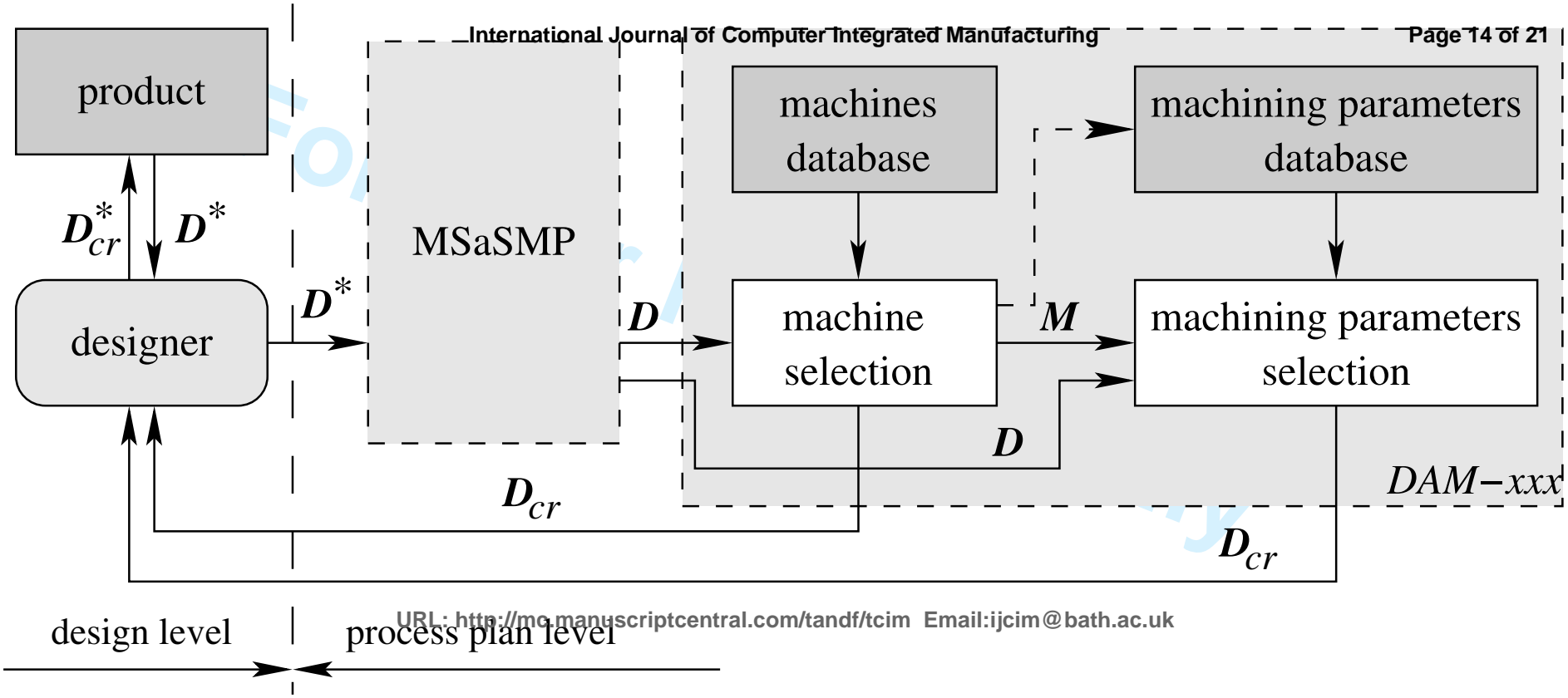

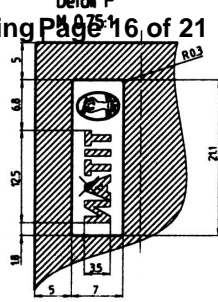
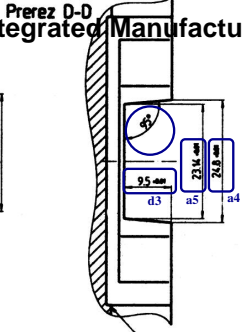
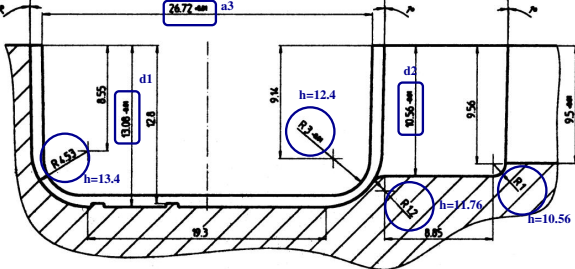

Prerez A-A

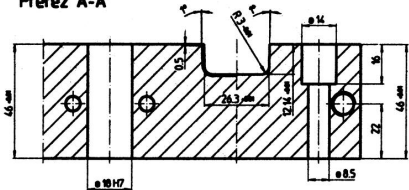

Prerez C-C

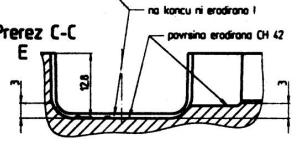

M 14

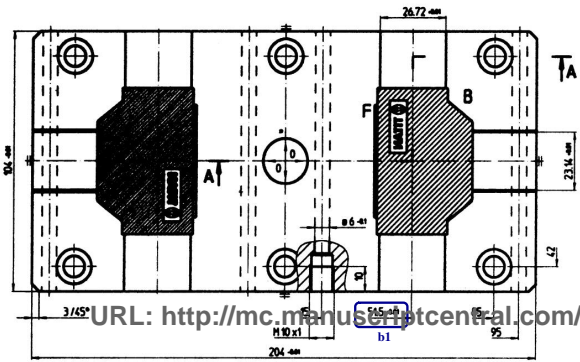

Detail B

M 12

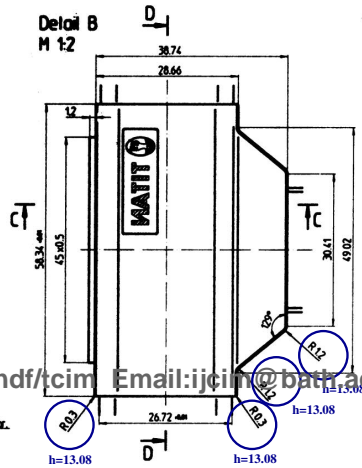

Instructions \ EDM machines \ Tool shape \ Tolerances 1/2 \ Tolerances 2/2 \ Machining parameters \ Feature adaptation \

Priority	Working area [mm]			Axes	Precision [mm]		Name
	x	y	z		x,y	z	
1	300	200	200	1	0.03	0.03	Machine A
2	500	400	400	1	0.02	0.01	Machine B
3	500	400	300	3	0.01	0.01	Machine C <<
4	800	500	400	4	0.003	0.003	Machine D

Machining axes Axes

z 1

z-x 2

z-x-y 3

z-x-y-c 4

A database of available EDM machines
351x252mm (72 x 72 DPI)

View Only

Instructions \ EDM machines \ Tool shape \ Tolerances 1/2 \ Tolerances 2/2 \ Machining parameters \ Feature adaptation \

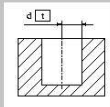
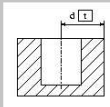
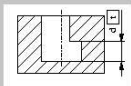
Type 'a' tolerances: Dimensional tolerances in the feature and parallel to the machining direction	Type 'b' tolerances: Dimensional tolerances outside of the feature and parallel to the machining direction	Type 'c' tolerances: Dimensional tolerances in the feature and perpendicular to the machining direction
		
1: <input type="text" value="0.01"/> 2: <input type="text" value="0.01"/> 3: <input type="text" value="0.01"/> 4: <input type="text" value="0.01"/> 5: <input type="text" value="0.01"/>	1: <input type="text" value="0.01"/> 2: <input type="text" value=""/> 3: <input type="text" value=""/> 4: <input type="text" value=""/> 5: <input type="text" value=""/>	1: <input type="text" value=""/> 2: <input type="text" value=""/> 3: <input type="text" value=""/> 4: <input type="text" value=""/> 5: <input type="text" value=""/>
<input type="button" value="Machine selection"/>		

Required tolerances (1/2) of the feature to be machined by the EDM
386x252mm (72 x 72 DPI)

Review Only

Instructions \ EDM machines \ Tool shape \ Tolerances 1/2 \ Tolerances 2/2 \ Machining parameters \ Feature adaptation

Type 'd' tolerances: Dimensional tolerances outside of the feature and perpendicular to the machining direction	Type 'e' tolerances: Shape tolerances of the cylinder	Type 'f' tolerances: Position tolerances of the feature of the tool
--	--	--

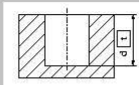

1:	0.01
2:	0.01
3:	0.01
4:	
5:	

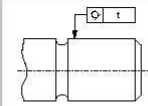

1:	
2:	
3:	
4:	
5:	

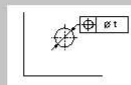

1:	
2:	
3:	
4:	
5:	

Machine selection

Required tolerances (2/2) of the feature to be machined by the EDM
351x252mm (72 x 72 DPI)

New Only

Instructions \ EDM machines \ Tool shape \ Tolerances 1/2 \ Tolerances 2/2 \ Machining parameters \ Feature adaptation

Tool material:

Eroding surface size: mm

Feature depth: mm

Surface roughness Ra: um

Depth of the HAZ: um

Are Ra and HAZ valid for vertical slopes? yes no

Inclination of planes inclined more than 5 degrees: deg

Roundness, depth 1: r = mm, h = mm

Roundness, depth 2: r = mm, h = mm

Roundness, depth 3: r = mm, h = mm

Roundness, depth 4: r = mm, h = mm

Roundness, depth 5: r = mm, h = mm

Electrode material:

Number of electrodes:

Rough regime:

Fine regime: Polish

Change regime at depth:

hi[1][7]	=	12.9799
hi[1][6]	=	0.04
hi[1][5]	=	0.0199
hi[1][4]	=	0.0099
hi[1][3]	=	0.0299
hi[2][7]	=	12.04
hi[2][6]	=	0.04
hi[2][5]	=	0.0199
hi[2][4]	=	0.0099
hi[2][3]	=	0.0299
hi[3][7]	=	10.46
hi[3][6]	=	0.04
hi[3][5]	=	0.0199
hi[3][4]	=	0.0099
hi[3][3]	=	0.0299
hi[4][7]	=	10.46
hi[4][6]	=	0.04
hi[4][5]	=	0.0199
hi[4][4]	=	0.0099
hi[4][3]	=	0.0299
hi[5][7]	=	12.9799
hi[5][6]	=	0.04
hi[5][5]	=	0.0199
hi[5][4]	=	0.0099
hi[5][3]	=	0.0299

Electrode edge wear length:

ld[5]	=	1.5615
ld[5][5]	=	-0.0018
ld[5]	=	1.5633
ld[5][4]	=	7.0E-4
ld[5]	=	1.5641
ld[5][3]	=	-0.0023
ld[5]	=	1.5665

Machining parameters selection

Feature adaptation for the ease of manufacturing - design and manufacturing parameters before the adaptation.

386x252mm (72 x 72 DPI)

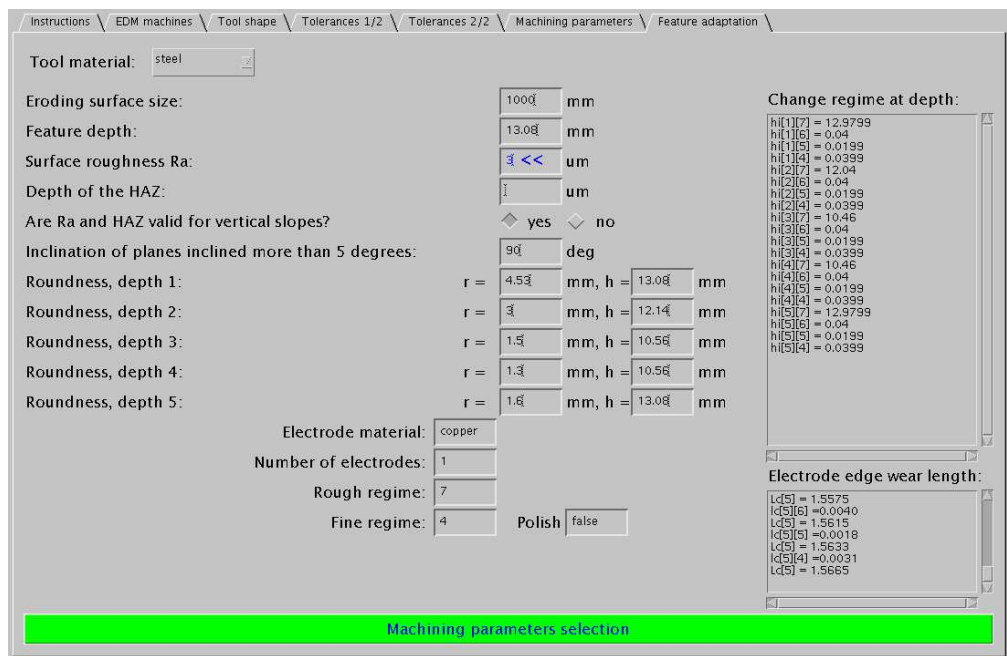

Feature adaptation for the ease of manufacturing - design and manufacturing parameters after the adaptation.
386x251mm (72 x 72 DPI)

view Only