



HAL
open science

(Special Issue STEP-NC) Integrating the CAx Process Chain for STEP Compliant NC Manufacturing of Asymmetric Parts

Stefan Heusinger, Roberto Ubertino Rosso, Peter Klemm, Stephen T Newman

► **To cite this version:**

Stefan Heusinger, Roberto Ubertino Rosso, Peter Klemm, Stephen T Newman. (Special Issue STEP-NC) Integrating the CAx Process Chain for STEP Compliant NC Manufacturing of Asymmetric Parts. *International Journal of Computer Integrated Manufacturing*, 2006, 19 (06), pp.533-545. 10.1080/09511920600622098 . hal-00513371

HAL Id: hal-00513371

<https://hal.science/hal-00513371>

Submitted on 1 Sep 2010

HAL is a multi-disciplinary open access archive for the deposit and dissemination of scientific research documents, whether they are published or not. The documents may come from teaching and research institutions in France or abroad, or from public or private research centers.

L'archive ouverte pluridisciplinaire **HAL**, est destinée au dépôt et à la diffusion de documents scientifiques de niveau recherche, publiés ou non, émanant des établissements d'enseignement et de recherche français ou étrangers, des laboratoires publics ou privés.



**(Special Issue STEP-NC) Integrating the CAx Process Chain
for STEP Compliant
NC Manufacturing of Asymmetric Parts**

Journal:	<i>International Journal of Computer Integrated Manufacturing</i>
Manuscript ID:	TCIM-2006-IJCIM-0018
Manuscript Type:	Special Issue Paper
Date Submitted by the Author:	02-Feb-2006
Complete List of Authors:	Heusinger, Stefan; Universität Stuttgart, ISW; VDE, DKE Rosso, Roberto; Universidade do Estado de Santa Catarina, Departamento de Ciencia da Computacao Klemm, Peter; Universität Stuttgart, ISW Newman, Stephen; University of Bath, Department of Mechanical Engineering
Keywords:	STEP NC, MACHINING PROCESSES, CNC MACHINING, CAD/CAM, CAPP
Keywords (user):	Turning



Integrating the CAx Process Chain for STEP Compliant NC Manufacturing of Asymmetric Parts

S. Heusinger^{1*}, R. S. U. Rosso-Jr^{2,3*}, P. Klemm¹, S. T. Newman³ and S. Rahimifard³

¹ ISW, University of Stuttgart, Seidenstr 36, Stuttgart, 70174, Germany

² Department of C. Sciences, Santa Catarina State University, Joinville, SC, 89223-100, Brazil

³ AMST Centre, Loughborough University, Loughborough, LE11 3TU, United Kingdom

* Correspondent authors: Stefan.Heusinger@isw.uni-stuttgart.de

Roberto.Rosso@Joinville.udesc.br

ABSTRACT

Acceleration of product development, decrease of NC programming effort and increase of product quality are demands from enterprises to make their products competitive. These requirements are hardly met by the today's used CAx process chain which is based on a multitude of interfaces and the standardised control data format ISO 6983. New concepts of product data modelling are necessary for a structured and object-oriented description of machining.

The development of STEP-NC (ISO 14649) over the last ten years has brought new opportunities for automating the CAx process chain. This paper portrays a methodology for implementation of a standardised CAx process chain for rotational asymmetric parts, which are described in the technology-oriented process model for turning (ISO 14649-12). The methodology is realised through a suite of STEP compliant NC software tools, based on STEP compliant information models to integrate the whole chain from design to machining. Component case studies are used to demonstrate and analyse the methodology. The final part of the paper discusses the major issues and deficiencies related to the current phase of development of this new approach.

1 Introduction

Today, products are required to be available in shorter and shorter time spans. At the same time, higher product complexity, quality requirements and requirements on a flexible adaptation to product maintenance and product variants result in a longer time span from conception to production. Thus, the efficiency of product development plays an increasingly important role for the economic performance of an industrial enterprise [Bjoerke1992]. Product development includes product planning, CAD (Computer Aided Design) in construction departments, NC (Numerical Control) planning and NC programming in a CAP system (Computer Aided Planning) and processing of the generated control data at the machine tool [Krause1993]. A special focus within the product development process lies in the CAx process chain which connects construction, programming and manufacturing of parts. There are more and more attempts to attain an integrated support of functions of these process chains like the generation of geometry data, part calculation, process planning and the generation of manufacturing data by the use of software tools [Krause1993]. Future-oriented concepts are dealing with “Virtual Production“ or the “Virtual Machine Tool“ for instance. Successful application of these concepts requires the use of one single, standardised data exchange format and respective methods in the total integrated CAx process chain. Up to now, the major bottleneck has been the provision of an appropriate data format and data integration, in particular at the interface between NC programming and Numerical Control. The new standard ISO 14649 (STEP-NC) overcomes the existing deficits and allows by the provision of geometry- and technology-oriented process models for the formulation of machining tasks.

2 Current situation

Today's CAx process chain is insufficient in supporting the demand for consistency of data. The process chain of construction and NC programming consists of stand-alone CAD and CAP systems or is realised by an integrated system. Stand-alone systems make use of standardised data exchange formats such as IGES (Initial Graphics Exchange Specification). The target data format for input in the NC is the machine-dependent data format based on ISO 6983 [ISO6983]. This is normally generated as the direct output format of the NC programming system. A major characteristic of this kind of process chain is the need for interconnecting software for the conversion as well as the extension and modification of the interchanged data, as shown in the left hand side of figure 1. Usually, this solution comes with a loss of information due to the need of conversion. For example, the information about the workpiece geometry is lost by the conversion to ISO 6983 as its sole description is that of the tool paths. Additional disadvantages are unidirectional data exchange, absence of consistency of data, low level information, and an absence of highly sophisticated functions such as five-axis machining [Storr2002].

Consequently, the following requirements for a process chain with incorporated systems and interfaces is as follows:

- I. An integrated process chain with a unified digital data representation from the CAD system, via CAP system to NC to ensure no loss of information at the data interfaces.
- II. The description of additional product information and features like tolerances, delivery dates, production costs, and service details.
- III. A central data pool for all systems in the process chain.

- IV. A bi-directional process chain for feedback of process data, to attain better diagnostic functions for the process (e.g. chatter avoidance) or machine adjustments (e.g. axis parameters) as well as the provision of optimised machining parameters.
- V. Provision of extended, standardised functionalities such as spline functions etc.
- VI. Accumulation of information and know-how about the product development from all departments, starting in the design up to the manufacturing department in order to support the user.
- VII. Description of the machining task without regard to a specific machine tool (machine-independent representation).

[insert figure 1 about here]

3 Product and process modelling with STEP-NC

The previously mentioned requirements make a completely new approach to product representation and NC programming necessary. It leads to an approach for the complete modelling of products across the product life cycle [Storr1996]. ISO 10303 (STEP = STandard for the Exchange of Product model data) [ISO10303-1] provides the definition of the information needed in the process chain from design to manufacturing. STEP offers a data format for the realisation of standardised interfaces [ISO10303-21] for the exchange of product data. The basis is formed by an object-oriented product model which is defined in the data modelling language EXPRESS [ISO10303-11] and also described in the STEP standard which specifies the information extent for an unambiguous description of products. The description

elements are entities which allow an abstract definition of arbitrary objects by use of their subordinated attributes.

The fundamental characteristic of the STEP approach is the feature which represents a geometric object of a workpiece. It is interpreted as a standardised, semantic-afflicted information and integration object. One major issue is that the term “feature” is not uniformly defined as yet [Vajna1997]. Instead, terms like object, technical element, shape element, function element or manufacturing element are often used. Major properties of features for use in CAD and CAP are a syntax to describe the shape, semantics to describe the technical meaning, and relations between syntax and semantic elements.

For the machining of features on machine tools, it is preferable to use manufacturing features as defined in AP 224 [ISO10303-224]. These features contain information from the machining viewpoint and thus differ from CAD construction features. To transfer construction features of the CAD system into manufacturing features of the NC programming system, feature recognition is usually applied. This means the extraction and generation of features out of geometry data of a CAD system. Another form of transfer can be provided by feature mapping i.e. the transmission of a feature from one to another representation.

Besides the machining features, additional technology-oriented methods and description elements are necessary, to describe the manufacturing process. This information is included in the machining model of STEP-NC (STEP-compliant data interface for Numerical Controls) [ESPRIT][ISO14649-10]. The manufacturing process is described by machining operations (*machining_operation*) applied to associated features (*machining_feature*). The machining operation defines a single working step which contains technical information (e.g. machining strategy),

technological parameters (e.g. feed and revolution speed) as well as the utilised tool. The information model element to structure the machining task is the main workplan (*workplan*) which contains either subordinate workplans or elementary machining working steps (*machining_workingstep*) [ISO14649-10]. The sequence of machining working steps is decisive for the sequence of machining the workpiece. It may be determined by the programmer or partly automated by the programming system, but depends on manufacturing-specific frame conditions (e.g. undertaking the finishing operation of a feature never before the roughing operation). Figure 2 shows the connections between the most important information model elements of STEP-NC [ISO14649-10][ISO14649-12].

[insert figure 2 about here]

The benefits by using a feature-based process chain can be derived from the following characteristics of STEP-NC:

- STEP-NC allows the programming of a machining task based on features and machining operations. The distinction between the part program and the NC program can be omitted. A STEP-NC program file contains all the construction and manufacturing information (geometry, machining operations, machining strategies, technologies, etc.) in an explicit form and has also the option to define tool paths.
- The larger information content and the better structure of a STEP-NC program compared to an ISO 6983 NC program make program modifications at the shop floor simpler and better comprehensible. Thus, programming errors are reduced significantly.

- The idea to use the same standardised data format within the whole process chain (CAD system, CAP system, and NC) makes, for the first time, a real bi-directional data exchange between the applications possible. As no conversions between different data formats are required, information loss is prevented. Besides, the interoperability between different machine tools and with different controllers will be simplified. By feedback of process data a closed loop of the process chain can be constructed.
- The post processor functionality can be placed to the best advantage in the NC. Only one post processor is required, which has to adapt the STEP-NC program to the respective machine tool / NC combination. Thus, external post processors and the effort for their administration and maintenance are no longer needed.
- Both, the NC and the programmer will be provided with an information base, which allows significantly enhanced functionality and optimisation possibilities (i.e. changing of machining sequence and machining parameters). By the bi-directional capability of the interface, feedback of modified STEP-NC data to a centralised data base or STEP-NC CAD/CAP/CAM and even to other NC machines is possible.
- All functions incorporated in the product development process (construction, process planning, manufacturing) interact and work with the same STEP-NC data base. Thus, necessary modifications and the required expertise are conserved and help to increase the efficiency of process planning.

4 Technology-oriented process model for turning

To satisfy the requirements of machining modelling several different, technology-specific process models within STEP-NC are necessary. Besides models for

milling/drilling, EDM (eroding) and inspection planning a turning model [ISO14649-12] has been developed as an important part of the new ISO standard (figure 2). The proposed document has been initially developed at ISW, University of Stuttgart, and consequently in co-operation with POSTECH University (Korea). The process is modelled with respect to compatibility to STEP and to the existing process models of STEP-NC.

The contents of the turning model is based on a requirements analysis of industrial users as well as on existing standards (e.g. DIN 8589 [DIN8589]). The main goal when developing the turning model was to cover the machining possibilities provided by use of ISO 6983, but additionally to make available the extended functionalities of STEP-NC. The model is structured, as shown in figure 2, with the geometry elements (manufacturing features), processes (machining operations), machining strategies, technology, machine functions and tools. The characteristics of the turning model are listed below:

- The manufacturing features contained in the turning model allow the description of the part to be manufactured. The geometry elements and their representation as manufacturing features of STEP-NC are shown in figure 3. The cut-in element often used in industry has no corresponding feature in STEP-NC since its geometry is implicitly defined by the tool's shape. Common for all features is their extension with manufacturing oriented characteristics. For instance, the characteristic "material side" represents the orientation of material removal (outside vs. inside turning). With respect to this information, the NC generates tool paths, refines strategies and chooses alternative tools or it permits the machining if available tools are not suited.

- The manufacturing process of the single or individual manufacturing features can be described by the respective machining operations. Figure 3 shows the possible machining operations for the different features. For knurling and cutting-in one adequate operation is available, the other operations are split in roughing and finishing operations.
- Machining strategies determine the method of machining and are assigned to the machining operations (see figure 2). The machining strategies characterise the possible tool paths for the manufacture of the associated feature: unidirectional strategies only cut material by forward feed motion, bi-directional strategies however cut material by forward as well as backward tool paths. Particular strategies are defined for the machining of threads and knurls.
- The turning technology comprises of all technology-oriented parameters. Important parameters in this context are feed and spindle speed.
- Machine functions are all switching operations of a machine tool. The NC of the machine tool delegates the execution of these switching operations by use of PLC functionality (Programmable-Logic Controller). All usual machine functions such as switching on or off the coolant supply or rotation of spindles are integrated in this turning model. Additional functions are concerned with tool changes, palet clamping or new cooling techniques like dispersion of coolant.
- Tool modelling is mainly oriented on ISO standards for tool holders (ISO 5610 [ISO5610], DIN 6261 [ISO6261]) and cutting inserts/replaceable inserts (ISO 1832 [ISO1832]). Harmonisation will be achieved with ISO 13399 [ISO13399-1]. The tool model ISO 14649-121 [ISO14649-121] will not be further discussed through this is outside the scope of this paper.

[insert figure 3 about here]

The geometry elements shown in figure 3, allow in combination with the machining operations and the machining strategies the representation of every conventional turning workpiece that can be manufactured on a machine tool. These elements are instantiated and parameterised for the data exchange based on the physical file format of ISO 10303-21 [ISO10303-21]. Figure 4 shows the representation of the manufacturing feature “cone“ and the associated machining operation “roughing cone“ for example. The bottom part of the figure shows a section of the corresponding STEP-NC data file.

[insert figure 4 about here]

5 Implementation

To show the benefits of the STEP-NC approach, a prototype implementation of an integrated, unified, and bi-directional process chain has been developed. Since commercial STEP-NC based CAD and CAP systems are not available, existing systems were analysed and extended or equipped with coupling modules with respect to the requirements of the process chain. Based on the turning model, the development of sample applications started at the ISW, University of Stuttgart.

In the first step a test workpiece had to be defined. The overall structure of the workpiece had to meet the requirements for applying the typical features and operations for turning. The designed workpiece is shown in figure 5. Besides simple working steps for machining cylinders and cones the workpiece in particular is

characterised by more complex working steps for applying threads or relief grooves subsequent to the threads.

[insert figure 5 about here]

5.1 File based process chain

A file based process chain using a unique data exchange format is the first step leading to an integrated, unified, and bi-directional process chain. The realisation of the prototype process chain shown in figure 6 and the implementation on a turning machine tool was accomplished in close co-operation with the turning machine tool manufacturer Boehringer Werkzeugmaschinen GmbH.

[insert figure 6 about here]

The initial stage of the process chain consists of geometric data being received from a CAD system in a data file (ISO 10303-AP203). The software prototype STEPturn, developed by ISW and serving CAP functionality, reads in the CAD data and displays the part geometry (figure 7). To attain manufacturing features, algorithms for automatic feature recognition have been implemented. Input and assignment of machining operations as well as selection and input of technology parameters and strategies is achieved through use of STEPturn. In the final stage, a STEP-NC data file is generated for output. The shop-floor-oriented programming system WOturn also developed at ISW (figure 8) is suited for the creation and modification of STEP-NC data files by machine operators.

[insert figure 7 about here]

[insert figure 8 about here]

The conversion of STEP-NC data files is necessary since no STEP-NC-compliant NC for turning currently is available. This conversion is made to the ShopTurn data format of Siemens which is the input format to generate tool paths for the NC Siemens 840D of the Boehringer machine tool. The respective conversion tool is shown in figure 9 and fits with its softkeys within the user dialog of the HMI (Human Machine Interface) of the control system.

[insert figure 9 about here]

Having completed these steps the NC programs are available in the data format to be executed at the machine tool. For its execution the turning machine tool Boehringer NG200 is used. This machine type allows the integration of all available techniques, up to complete machining. From an end-users view point these cost-savings together with interoperable process chain usage provide the possibility to transfer NC programs to several machine tools without post-processing. Though it should be recognised that the benefits of a consistent data model cannot be implemented without the know-how of a machine tool manufacturer. Boehringer has supported the STEP-NC approach by providing a machine tool for detailed testing and representation of the STEP-NC turning model as well as with assistance in the setting-up operation. Boehringer deems this new data model to form a significant step to increase flexibility and to save costs in metal-cutting manufacturing.

5.2 Process chain based on a STEP-NC server

The demands with respect to a bi-directional process chain are hardly conceivable with file based data exchange mechanisms. To accomplish the full advantages of an integrated, unified, and bi-directional process chain the bi-directional connection of all systems involved in the process chain has to be enabled. For consistency of data a centralised database has been preferred. Hence, a structure as shown in figure 10 with a STEP-NC server is believed to be the best solution. A STEP-NC client has been assigned to each of the addressed subsystems (e.g. CAD or CAP). Each client is responsible for connecting to and disconnecting from the STEP-NC server and has to perform some adaptation (e.g. automatic feature recognition within the CAD client). The connection between server and client is designed with DCOM (Distributed Common Object Model). The STEP-NC server contains information models (e.g. ISO 14649-12) and machining models, which represent the STEP-NC code for the desired workpiece. The information models are used to check the validity of the elements used within the exchanged machining models. The verification of the machining models is achieved with the implemented rules of the information models. By transferring a machining model into the STEP-NC server the respective validation and verification algorithms are performed, and if no error occurs the model is instantiated. Thereafter, the binary access to the machining model for machining the workpiece on a machine tool is possible.

[insert figure 10 about here]

6 Further Developments

Future developments, especially for the process model of turning, are aimed at the extension of complete machining of turn mill components with its representation in XML schemas.

The trend to the creation of integrated process chains offers new possibilities for information supply to the whole product development. For instance, the internet provides quick exchange of product model data and thus allows new forms of cooperation within manufacturing. The use of the internet shall be achieved by the development of an XML schema for STEP-NC. The use of XML promises benefits in the processing of data and data models since many software tools are available and extended syntax checking is possible.

By use of complete machining, more and more working-steps should be executed on a single machine tool. A major role is played by several forms of turning/milling centres which complement conventional turning with milling and excentric drilling capability. Four procedures are distinguished to describe complete machining: Integration of several techniques (e.g. turning and milling on a single machine), simultaneous operation with several tools, simultaneous operation of several workpieces and machining of both sides of a turning workpiece without manual change of clamping. The operation with several techniques is possible since the corresponding process models (e.g. milling/drilling, turning) are available. For the other procedures parallel processing and synchronisation are required. Parallel processing means simultaneous execution of several operations in the machine tool. Synchronisation means the time sequence of workingsteps. With respect to this aspect, appropriate concepts are to be developed which allow complete and/or parallel

machining. Several dissertations deal with this topic [Li2001] which may form the basis for further development of STEP-NC.

At Loughborough University the development of a STEP compliant manufacturing model to support the Process Planning activity for turn-mill machining has started. It uses references to elements of ISO14649 (e.g. Parts 10, 11 [ISO14649-11], and 12) and of ISO 10303 (e.g. Parts 203 [ISO10303-203], 224, and 240 [ISO10303-240]) to maximise interoperable information. The use of this information model is twofold: to aid in the initial decisions in a CAP system to create STEP-NC compliant programs and to support the adaptation of a STEP-NC program to run on a specific machine. This design supports the third level of compliance for STEP compliant CAD/CAP systems as defined by [Rosso2002] and [Newman2003] and uses ISO/STEP elements in the definition of the information models to support their functionality.

The proposed manufacturing model is divided in two parts the resources capabilities and the process capabilities of a given workstation. With these, it is possible for the process planner to decide on which machine a given workpiece shall be machined and which tools and work holding devices are to be used. The rationale behind this model is that the workstation to manufacture a workpiece is constrained by the capabilities of the resources to perform the required processes with the required process specifications. Furthermore, to adapt the STEP-NC program to a specific machine a large amount of information is necessary and should be kept in an organised mode. An initial view of the resources capabilities model which uses ISO 10303-224 or ISO 10303-240 and defines the tools close to the definitions of ISO 14649-111 (milling and drilling tools) [ISO14649-111] and ISO 14649-121 (tools for turning) is shown in figure 11.

This model forms the basis for further research on a STEP-NC compliant information structure to support both turning and milling operations on NC turning centres. It provides the basis to define additionally the milling capability of the NC turning centre, which can be mapped onto the mill/turn representations in parts 11 & 12 of ISO14649.

[insert figure 11 about here]

7 Conclusions

To accelerate product development, an integrated product representation is required. Product data management systems assist the departments incorporated in the development process. In today's CAx process chains, the consistency of data is lost at the latest in the output interface of the NC programming system. The new ISO standard 14649 provides the first data exchange format which will not only be used for part programs, but also be applied for the operation of a NC. Thus information-conservation and bi-directional integrated process chains from the CAD system, via the CAP system to the NC can be realised. In effect, the multiplicity of different interfaces and the resulting loss of information can be avoided. Thus, a STEP-NC approach can be used to describe machining tasks by use of technology-oriented process models.

By the extension of STEP-NC a process model for turning was developed. This model provides features and machining operations suited for turning. Machining strategies and the description of machine functions complete the turning model. First applications, like STEPturn or the shop-floor-oriented programming system (WOPTurn) have been developed. The conversion of STEP-NC code to ShopTurn has

made it possible to machine a test workpiece on a real machine tool from Boehringer Werkzeugmaschinen GmbH using a Siemens 840D control system. The full representation of the system leads to an integrated, unified, and bi-directional process chain based on a STEP-NC server.

8 References

- [Bjoerke1992] Bjoerke, O.; Myklebust, O.: IMPPACT ESPRIT 2165 Integrated Modelling of Products and Processes Using Advanced Computer Technologies. Tapir, Trondheim, 1992.
- [DIN8589] DIN 8589: Fertungsverfahren Spanen; Einordnung, Unterteilung, Begriffe. Berlin: Beuth, 1981.
- [ESPRIT] ESPRIT-IMS Project #29708 STEP-NC. <http://www.step-nc.org/>
- [ISO10303-1] ISO 10303-1: Industrial automation systems and integration – Product data representation and exchange – Part 1: Overview and fundamental principles. Geneva: ISO, 1992.
- [ISO10303-11] ISO 10303-11: Industrial automation systems and integration – Product data representation and exchange – Part 11: Description methods: EXPRESS language reference manual. Geneva: ISO, 1991.

- [ISO10303-21] ISO 10303-21: Industrial automation systems and integration – Product data representation and exchange – Part 21: Clear text encoding of the exchange structure. Geneva: ISO, 1992.
- [ISO10303-203] ISO 10303-203: Industrial automation systems and integration -- Product data representation and exchange – Part 203: Application protocol: Configuration controlled 3D designs of mechanical parts and assemblies. Geneva: ISO, 1994.
- [ISO10303-224] ISO 10303-224: Industrial automation systems and integration – Product data representation and exchange – Part 224: Application Protocol: Mechanical Product Definition for Process Planning Using Machining Features. Geneva: ISO, 2000.
- [ISO10303-240] ISO/CD 10303-240: Industrial automation systems and integration – Product data representation and exchange – Part 240: Application protocol: Process Plans for machined products. CD – Ballot Version, 2003.
- [ISO13399-1] ISO/DIS 13399-1: Cutting tool data representation and exchange – Part 1: Overview, fundamental principles and general information model. Geneva: ISO, 2004.

- [ISO14649-10] ISO 14649-10: Industrial automation systems and integration – Physical device control – Data model for computerized numerical controllers – Part 10: General Process Data. Geneva: ISO 2004.
- [ISO14649-11] ISO 14649-11: Industrial automation systems and integration – Physical device control – Data model for computerized numerical controllers – Part 11: Process data for milling. Geneva: ISO, 2004.
- [ISO14649-12] ISO/FDIS 14649-12: Industrial automation systems and integration – Physical device control – Data model for computerized numerical controllers – Part 12: Process data for turning. Geneva: ISO, 2004.
- [ISO14649-111] ISO/DIS 14649-111: Industrial automation systems and integration – Physical device control – Data model for computerized numerical controllers – Part 111: Tools for milling. Geneva: ISO, March 2004.
- [ISO14649-121] ISO/DIS 14649-121: Industrial automation systems and integration – Physical device control – Data model for computerized numerical controllers – Part 121: Tools for turning. Geneva: ISO, March 2004.

- [ISO1832] ISO 1832: Indexable inserts for cutting tools – Designation. Geneva: ISO, 1991.
- [ISO5610] ISO 5610: Single-point tool holders for turning and copying, for indexable inserts – Dimensions. Geneva: ISO, 1998.
- [ISO6261] ISO 6261: Boring bars (tool holders with cylindrical shank) for indexable inserts – Designation. Geneva: ISO, 1995.
- [ISO6983] ISO 6983: Numerical control of machines – Program format and definition of address words – Part 1: Data format for positioning, line motion and contouring control systems. Geneva: ISO, 1982.
- [Krause1993] Krause, F.-L. et al.: Product Modelling. In: CIRP Annals 1993, Keynote Papers, Vol. 42/2/1993, Hallwag Publishers, Bern, Stuttgart 1993, pp. 695-706.
- [Li2001] Li, R.: Agentenbasierte NC-Planung für die Komplettbearbeitung auf Dreh-/Fräszentren. Heimsheim: Jost Jetter Verlag, 2001. Zugl. Dissertation Universität Stuttgart, 2001.
- [Newman2003] Newman, S.T., Allen, R.D.; Rosso Jr., Roberto: CAD/CAM solutions for STEP Compliant CNC Manufacture. International Journal of Computer Integrated Manufacturing, Vol. 16, No. 7-8, 2003, 590-597.

- [Rosso2002] Rosso Jr., Roberto; Allen, R.D.; Newman, S.T.: Future Issues for CAD/CAM and Intelligent CAC Manufacture. Proceedings of the 19th International Manufacturing Conference – IMC-19. Queen's University Belfast – Belfast, Northern Ireland, 28, 29 and 30/August/2002, pp115-124.
- [Storr1996] Storr, A.; Itterheim, C.; Ströhle, H.: First Application of a New NC Interface Based on Machining Objects: User Oriented Modification for the Machining of Sculptured Surfaces. In: Proceedings of the 6th International FAIM Conference, Atlanta, May 13-15, 1996, S.237...245.
- [Storr2002] Storr, A.; Heusinger, S.: STEP-NC – Grundlage einer CAD/NC-Prozesskette – Das Prozessmodell für die Drehbearbeitung. wt Werkstattstechnik online 92 (2002) H.5, S. 210-217.
- [Vajna1997] Vajna, S.: Features zur Optimierung des Produktentstehungsprozesses und der datenverarbeitungstechnischen Integration. VDI 1322, Features verbessern die Produktentwicklung, 1997, S. 51-62.

List of figure captions

Figure 1: Comparison of a conventional and a feature-based process chain

Figure 2: Basic connections between information model elements of STEP-NC

Figure 3: Geometry elements and their representation in STEP-NC

Figure 4: Sample workpiece and its representation in a STEP-NC file

Figure 5: Test workpiece for validating the process chain

Figure 6: Implemented process chain for turning

Figure 7: Prototype CAP system: STEPturn

Figure 8: Prototype Shop Floor Programming system: WOPturn

Figure 9: Conversion tool for translating STEP-NC to ShopTurn format

Figure 10: Prototype process chain with a STEP-NC server

Figure 11: Proposal of a STEP compliant manufacturing model (resources)

Figures & captions

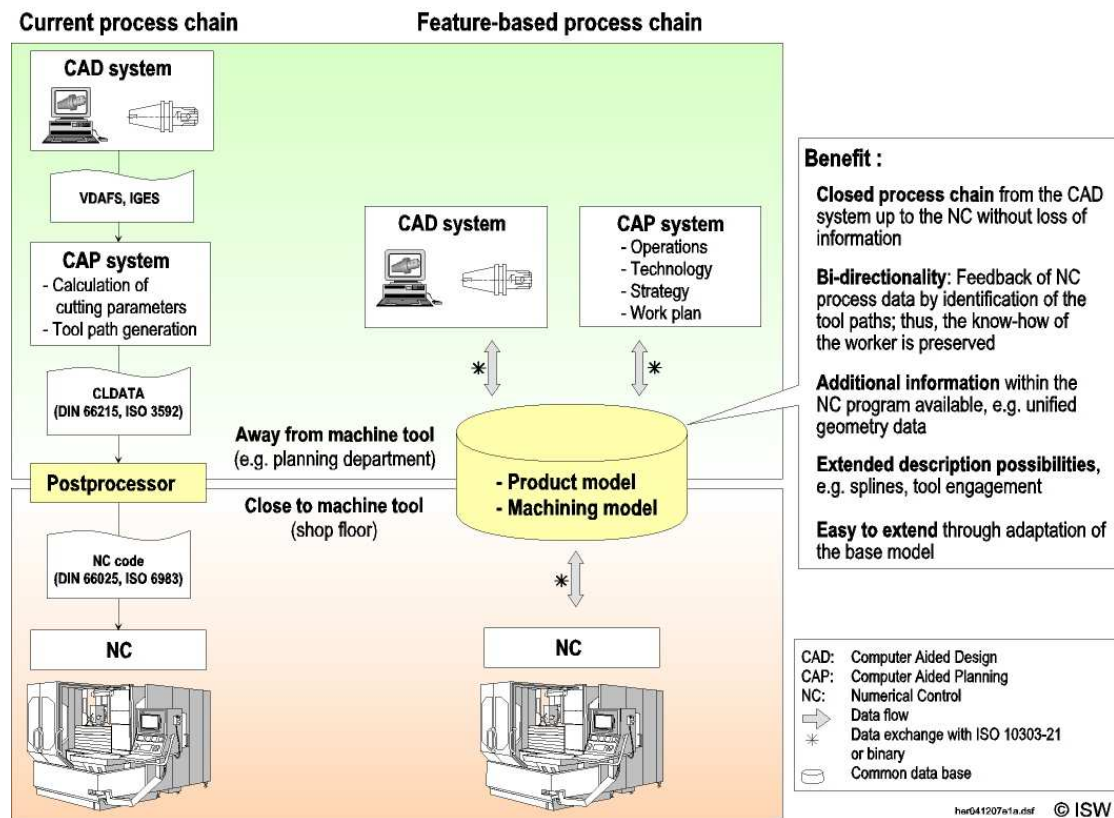

Figure 1: Comparison of a conventional and a feature-based process chain

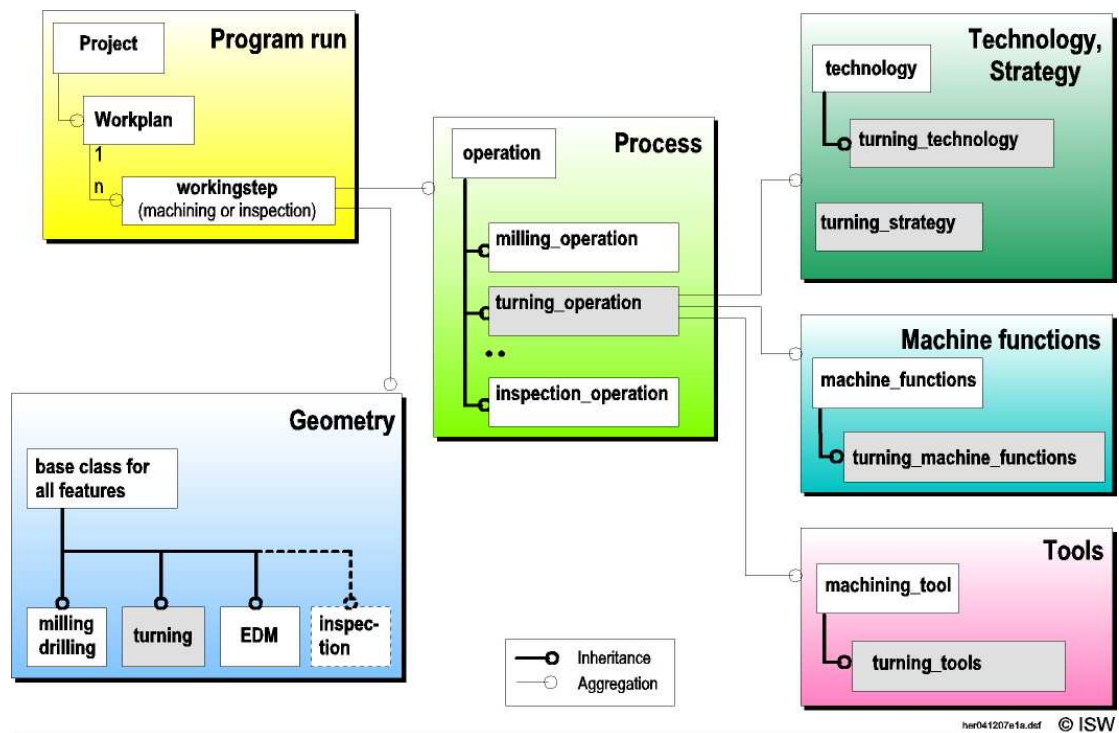
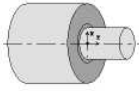
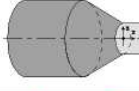
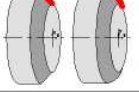
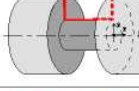

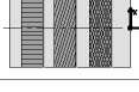



Figure 2: Basic connections between information model elements of STEP-NC

Geometry element	Denotation	Feature in STEP-NC	Possible operations
	- End face - Step	- outer_diameter_ to_shoulder	- Facing (rough and finish)
	- Cylinder - Cone	- outer_diameter	- Contouring (rough and finish)
	- Chamfer - Rounded corner	- revolved_flat - revolved_round	- Contouring (rough and finish)
	- Groove	- groove	- Contouring, grooving or multistep_grooving (resp. rough and finish)
	- General outside contour	- general_revolution	- Contouring (rough and finish)
	- Knurl	- knurl	- Knurling
	- Thread	- thread	- Threading (rough and finish)
	- Cut in		- Cutting_in

hor041207e1a.dxf © ISW

Figure 3: Geometry elements and their representation in STEP-NC

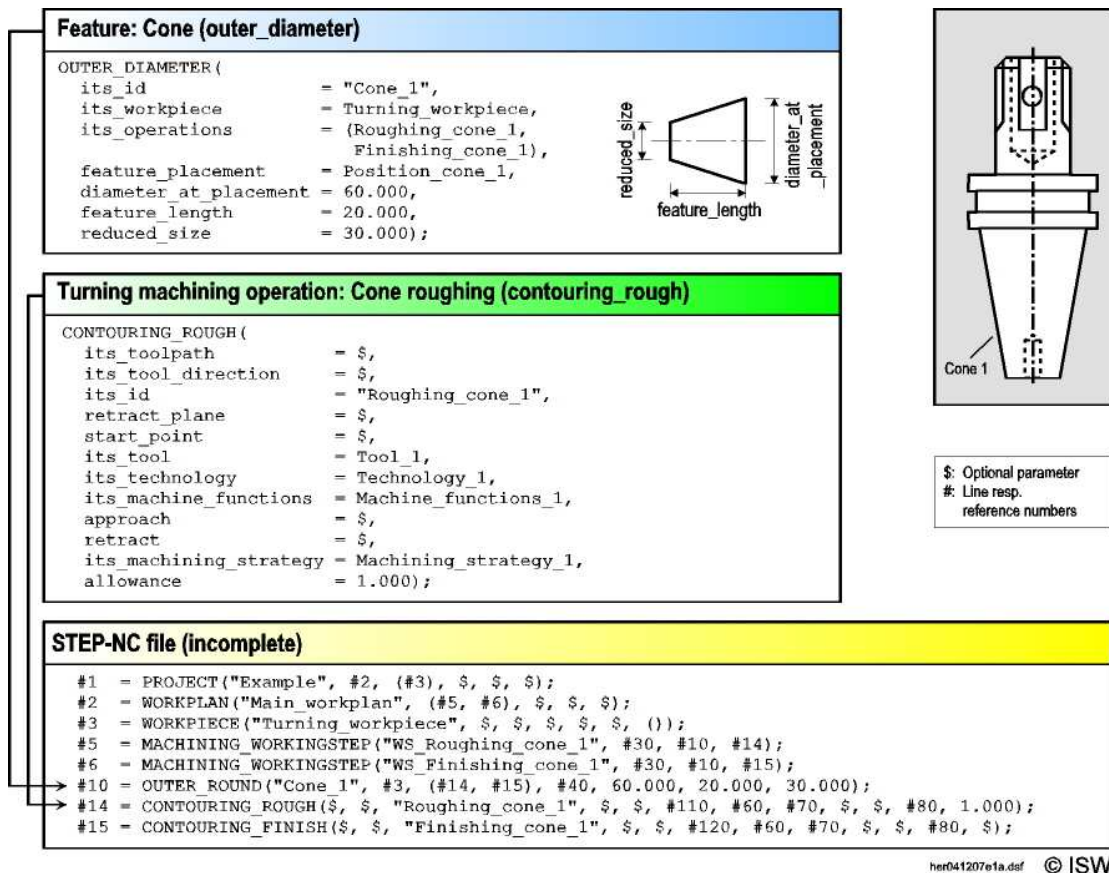

Figure 4: Sample workpiece and its representation in a STEP-NC file

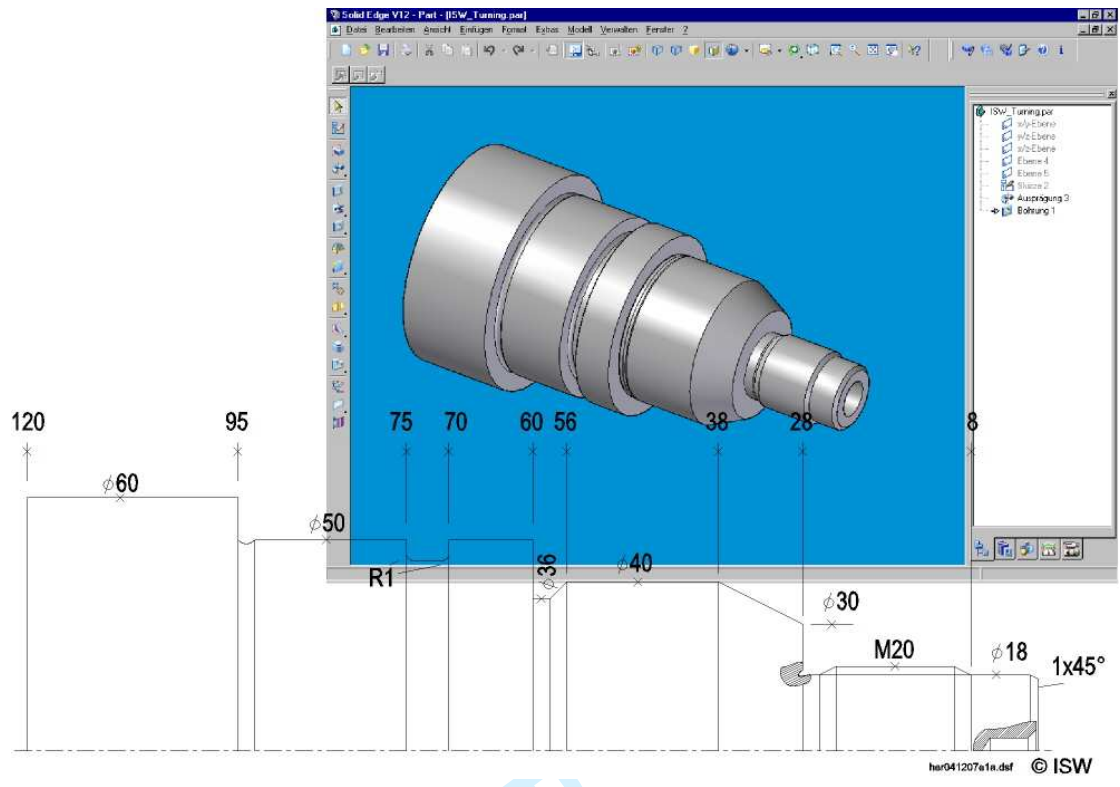

Figure 5: Test workpiece for validating the process chain

Review Only

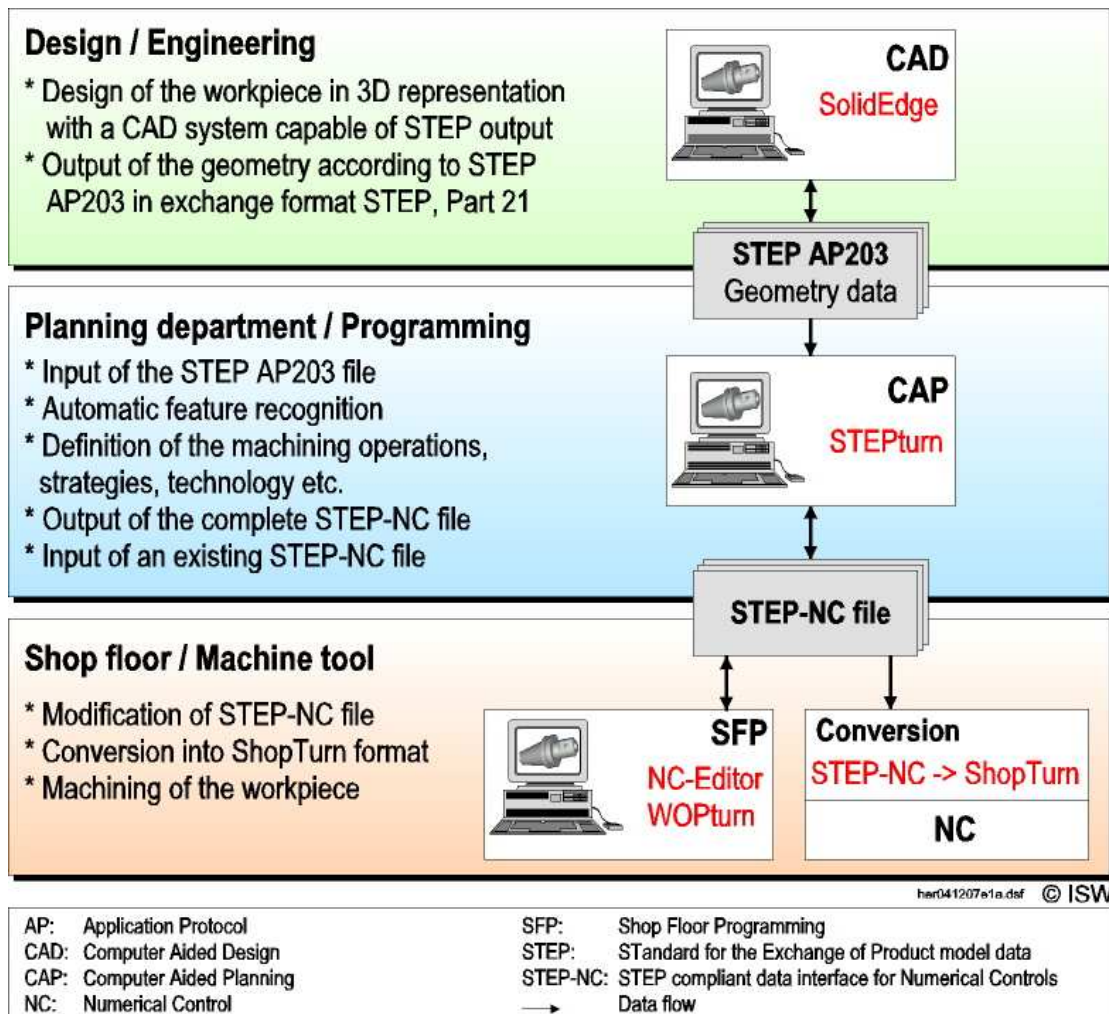

Figure 6: Implemented process chain for turning

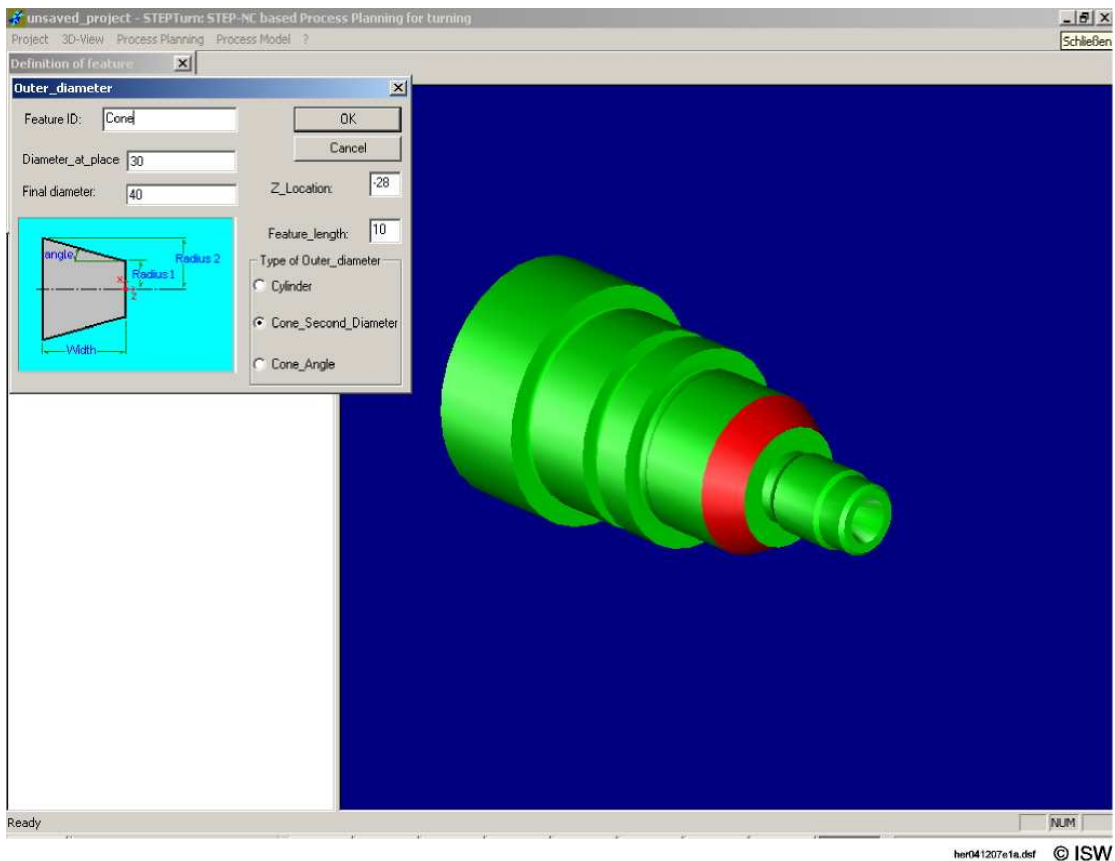

Figure 7: Prototype CAP system: STEPTurn

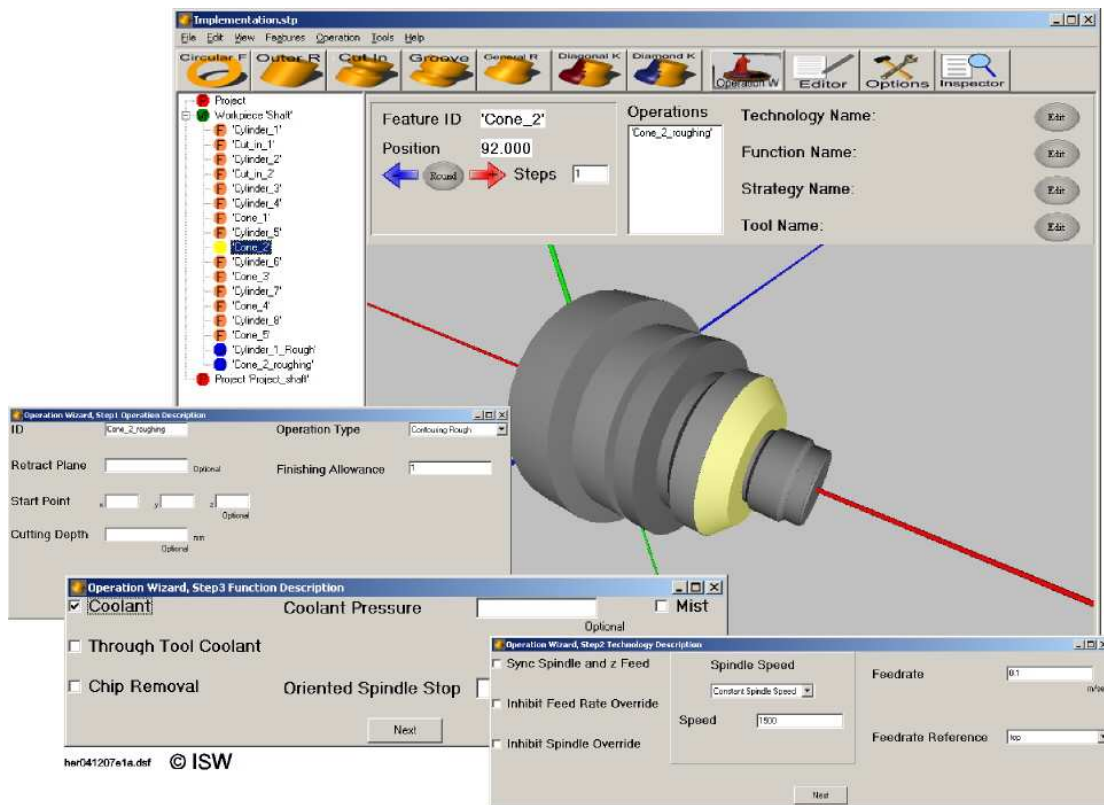

Figure 8: Prototype Shop Floor Programming system: WOPturn

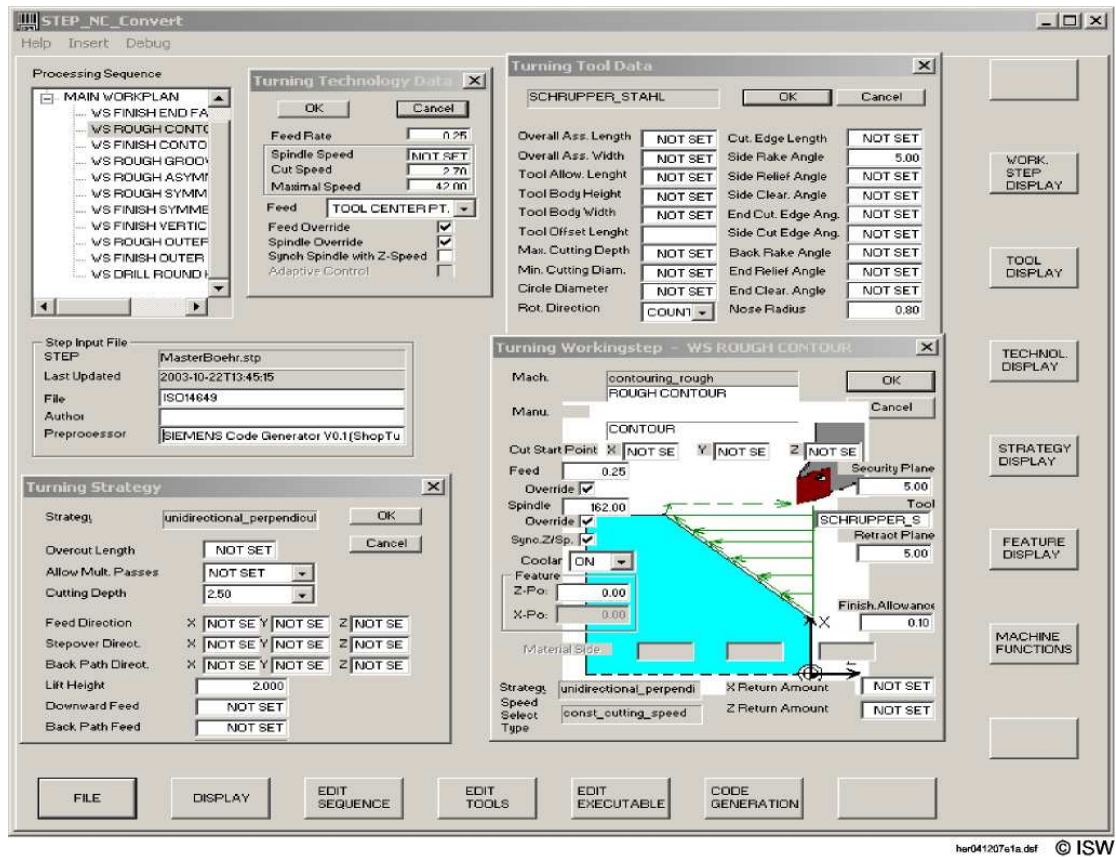

Figure 9: Conversion tool for translating STEP-NC to ShopTurn format

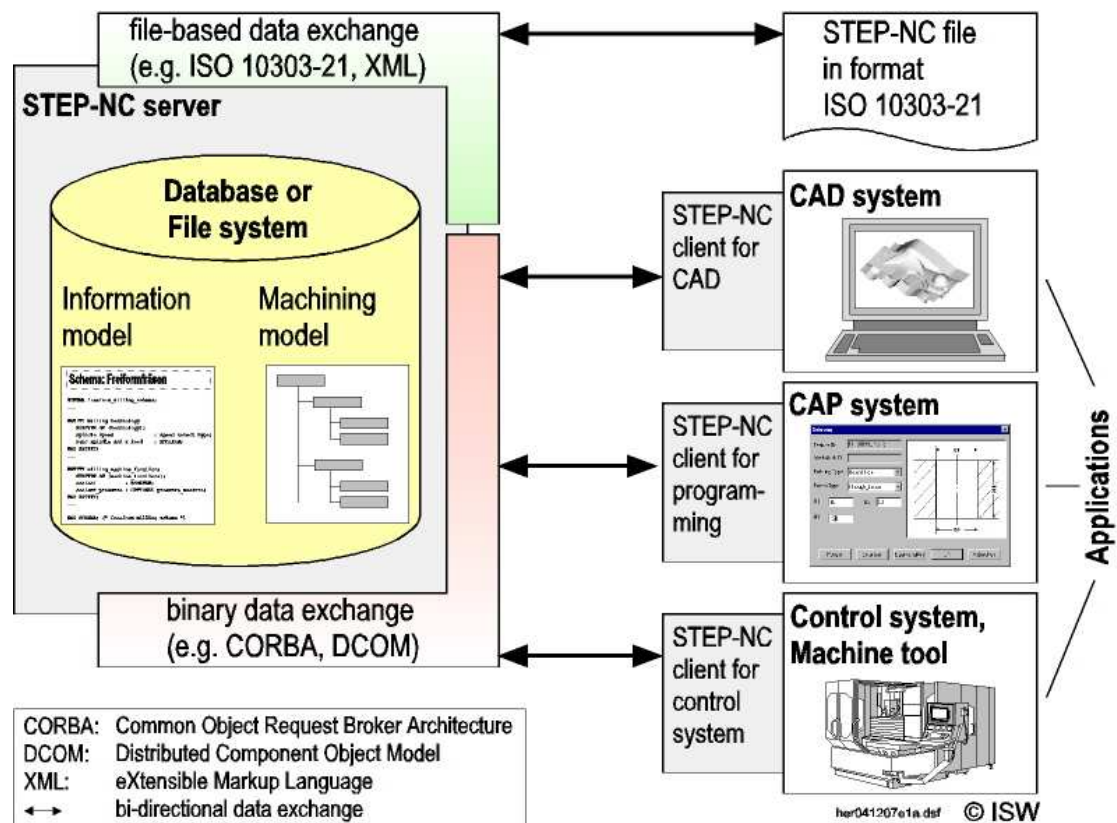

Figure 10: Prototype process chain with a STEP-NC server

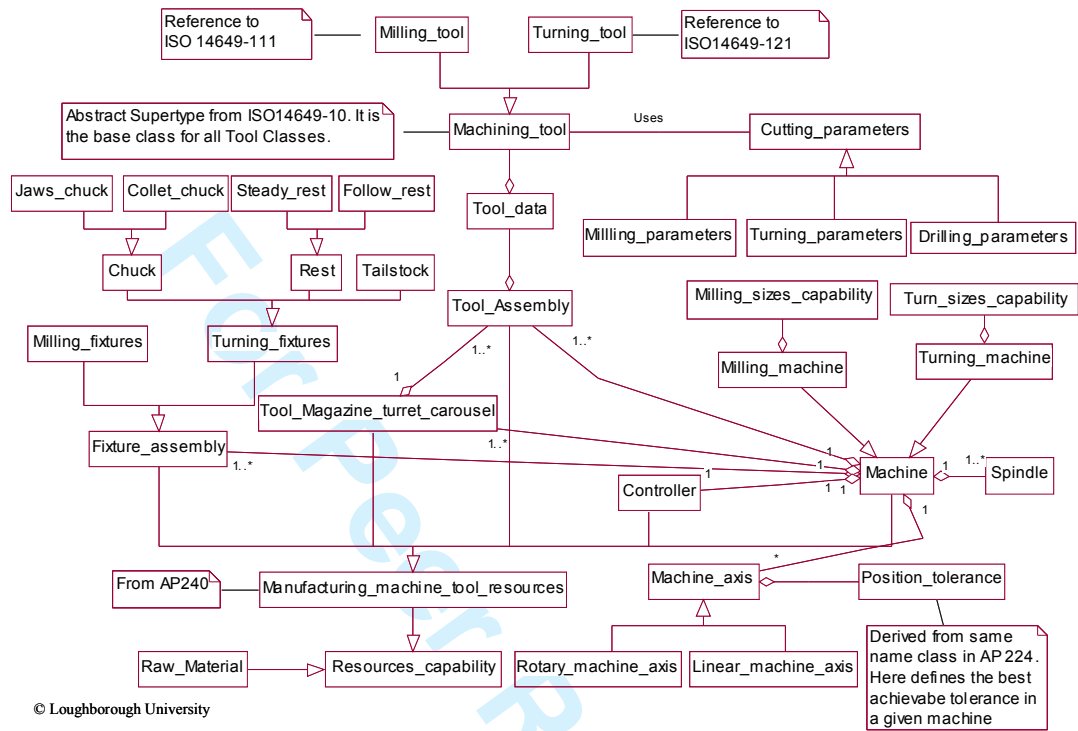
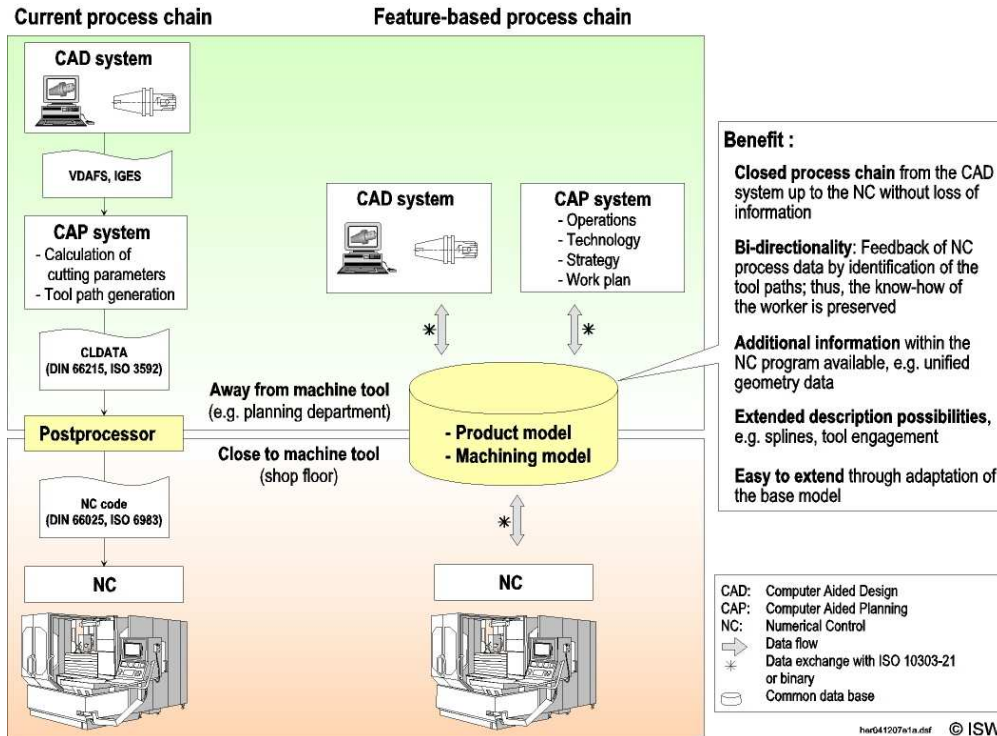
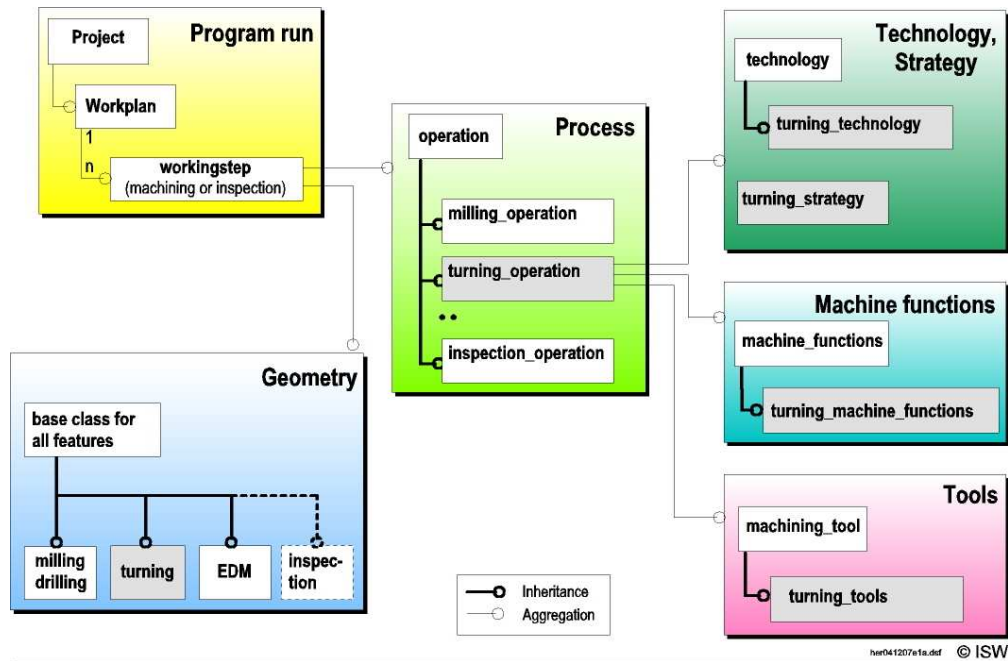

Figure 11: Proposal of a STEP compliant manufacturing model (resources)





278x205mm (96 x 96 DPI)

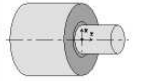
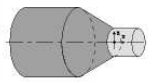
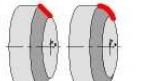
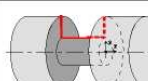
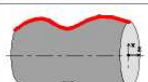

280x184mm (96 x 96 DPI)

Review Only

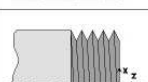
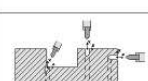
Geometry element	Denotation	Feature in STEP-NC	Possible operations
	- End face - Step	- outer_diameter_ to_shoulder	- Facing (rough and finish)
	- Cylinder - Cone	- outer_diameter	- Contouring (rough and finish)
	- Chamfer - Rounded corner	- revolved_flat - revolved_round	- Contouring (rough and finish)
	- Groove	- groove	- Contouring, grooving or multistep_grooving (resp. rough and finish)
	- General outside contour	- general_revolution	- Contouring (rough and finish)
	- Knurl	- knurl	- Knurling
	- Thread	- thread	- Threading (rough and finish)
	- Cut in		- Cutting_in

her041207e1a.dxf © ISW

245x201mm (96 x 96 DPI)

Feature: Cone (outer_diameter)

```

OUTER_DIAMETER(
  its_id           = "Cone_1",
  its_workpiece   = Turning_workpiece,
  its_operations  = {Roughing_cone_1,
                    Finishing_cone_1},
  feature_placement = Position_cone_1,
  diameter_at_placement = 60.000,
  feature_length  = 20.000,
  reduced_size    = 30.000);

```

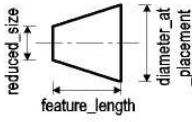

Turning machining operation: Cone roughing (contouring_rough)

```

CONTOURING_ROUGH(
  its_toolpath     = $,
  its_tool_direction = $,
  its_id           = "Roughing_cone_1",
  retract_plane    = $,
  start_point      = $,
  its_tool         = Tool_1,
  its_technology   = Technology_1,
  its_machine_functions = Machine_functions_1,
  approach         = $,
  retract          = $,
  its_machining_strategy = Machining_strategy_1,
  allowance        = 1.000);

```

STEP-NC file (incomplete)

```

#1 = PROJECT("Example", #2, (#3), $, $, $);
#2 = WORKPLAN("Main workplan", (#5, #6), $, $, $);
#3 = WORKPIECE("Turning workpiece", $, $, $, $, $, ());
#5 = MACHINING_WORKINGSTEP("WS Roughing_cone_1", #30, #10, #14);
#6 = MACHINING_WORKINGSTEP("WS Finishing_cone_1", #30, #10, #15);
#10 = OUTER_ROUND("Cone_1", #3, (#14, #15), #40, 60.000, 20.000, 30.000);
#14 = CONTOURING_ROUGH($, $, "Roughing_cone_1", $, $, #110, #60, #70, $, $, #80, 1.000);
#15 = CONTOURING_FINISH($, $, "Finishing_cone_1", $, $, #120, #60, #70, $, $, #80, $);

```

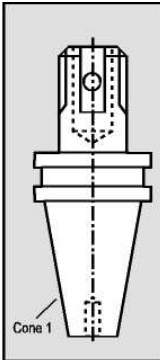

\$: Optional parameter
#: Line resp. reference numbers

her041207e1a.dxf © ISW

234x185mm (96 x 96 DPI)

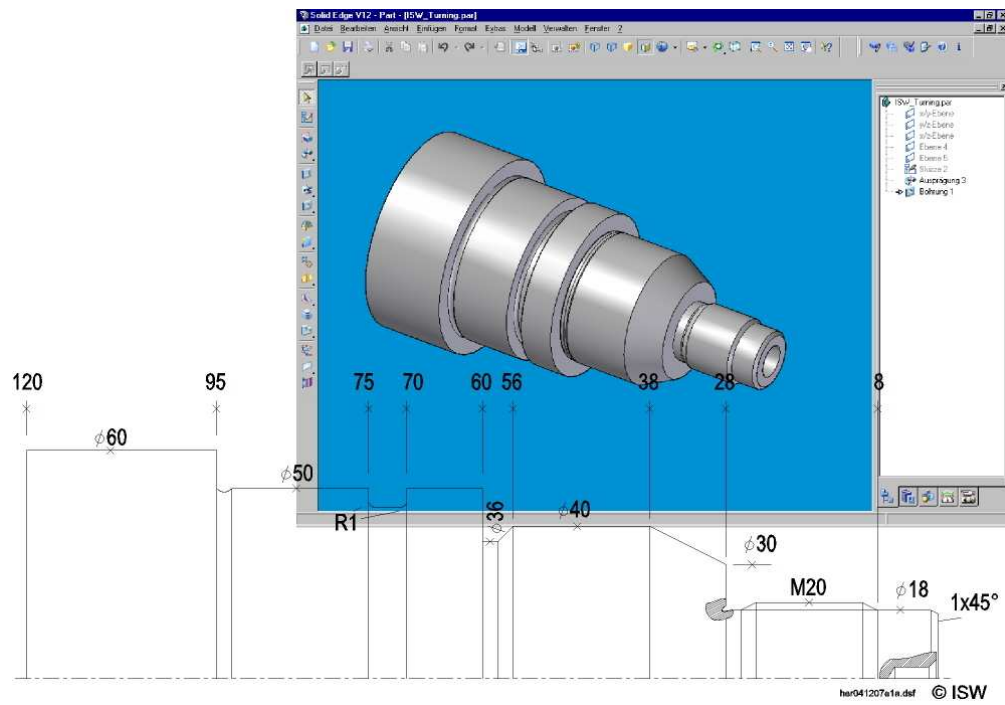

262x182mm (96 x 96 DPI)

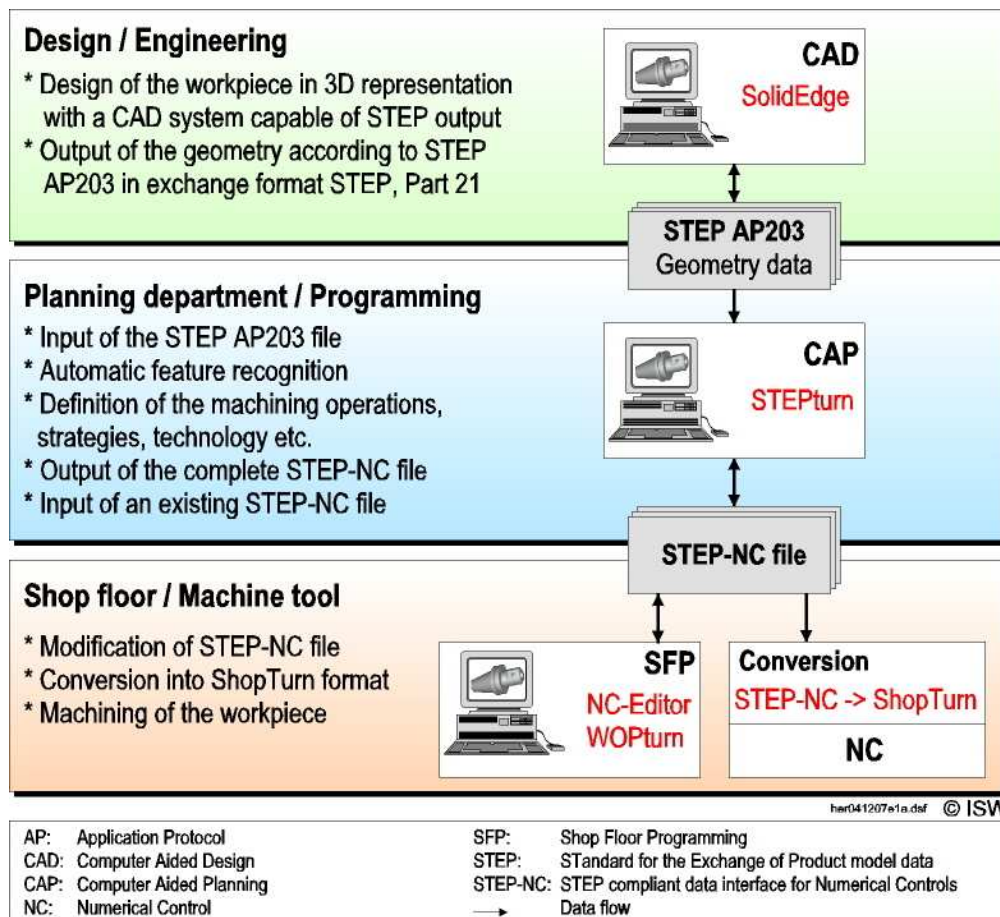

207x189mm (96 x 96 DPI)

Only

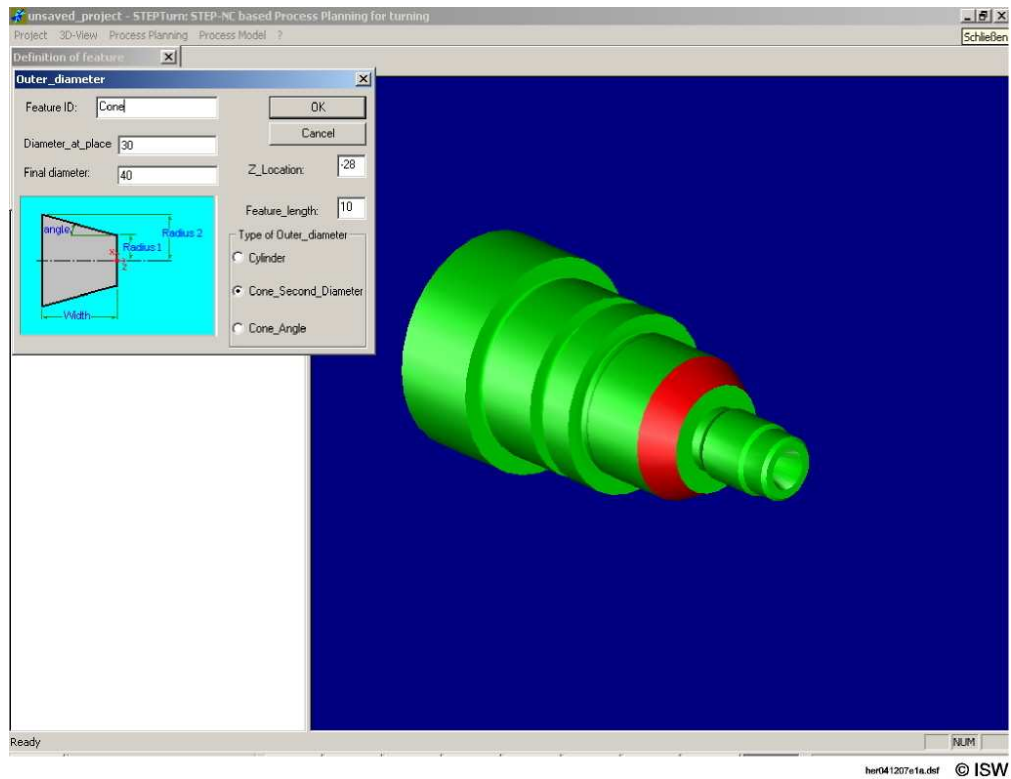

271x210mm (96 x 96 DPI)

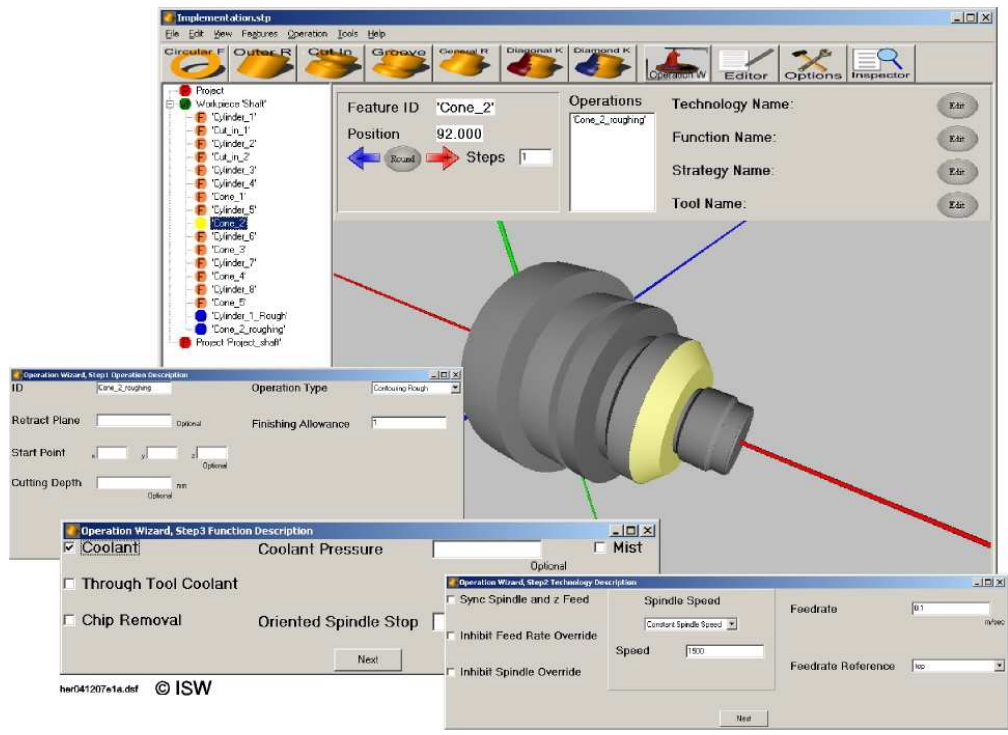

255x184mm (96 x 96 DPI)

View Only

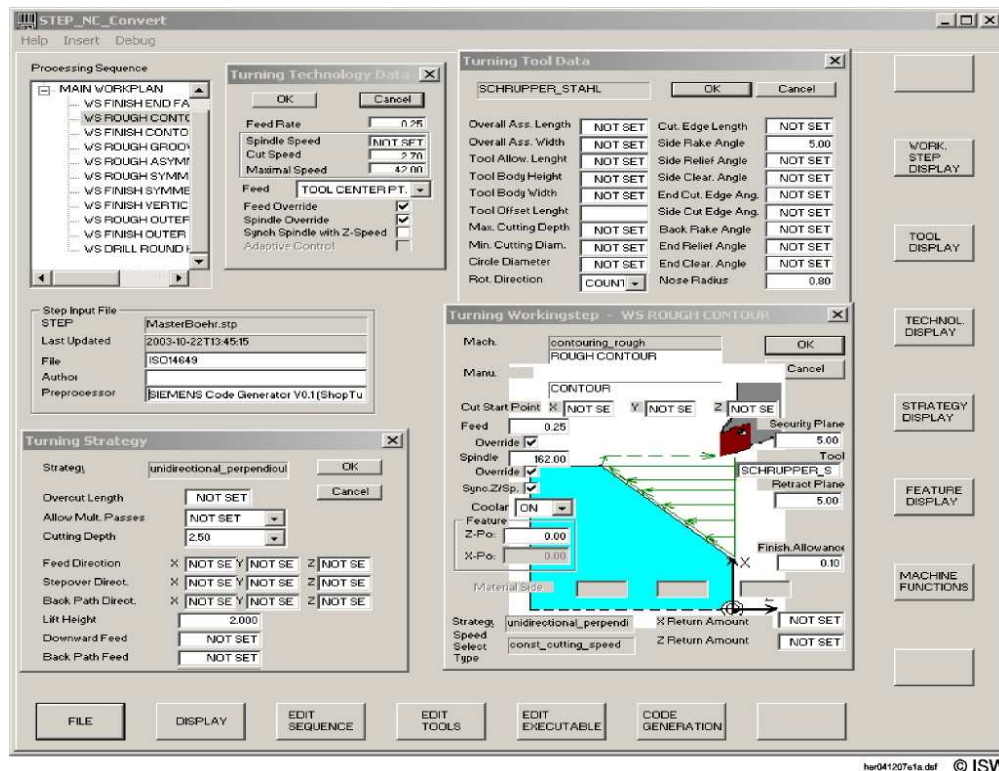

271x209mm (96 x 96 DPI)

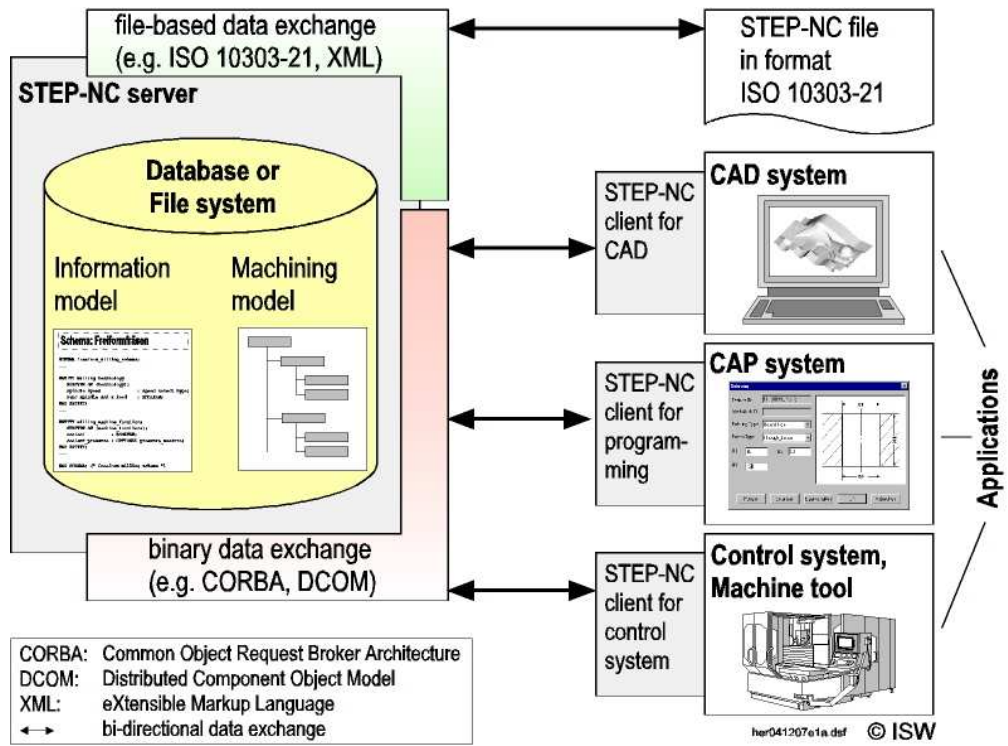

210x155mm (96 x 96 DPI)

new Only

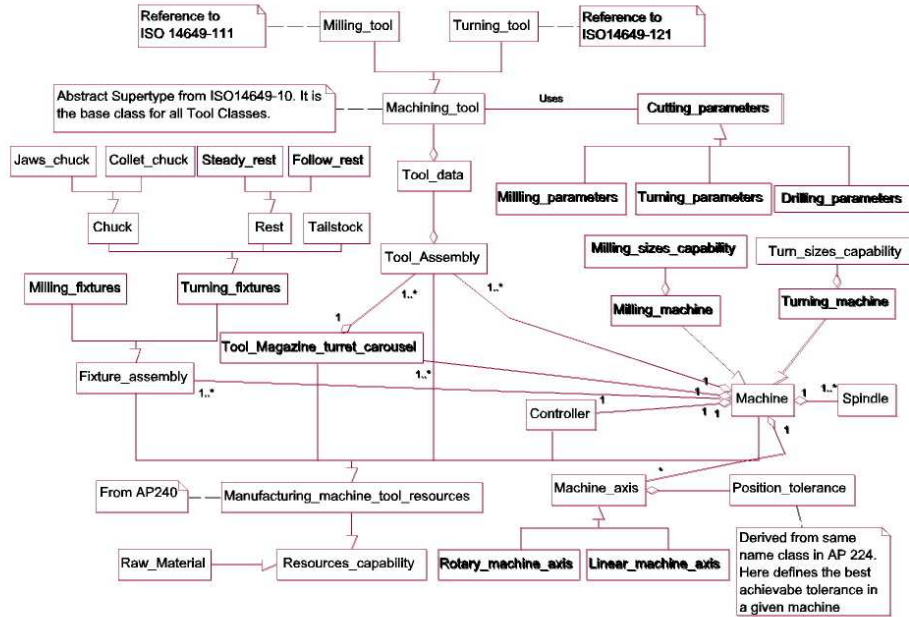

269x182mm (96 x 96 DPI)

view Only