



HAL
open science

A multidisciplinary model for floorplan design

Maria Gloria del Rio-Cidoncha, Juan Martínez Palacios, Juan Eugenio Iglesias

► **To cite this version:**

Maria Gloria del Rio-Cidoncha, Juan Martínez Palacios, Juan Eugenio Iglesias. A multidisciplinary model for floorplan design. *International Journal of Production Research*, 2007, 45 (15), pp.3457-3476. 10.1080/00207540600889550 . hal-00512937

HAL Id: hal-00512937

<https://hal.science/hal-00512937>

Submitted on 1 Sep 2010

HAL is a multi-disciplinary open access archive for the deposit and dissemination of scientific research documents, whether they are published or not. The documents may come from teaching and research institutions in France or abroad, or from public or private research centers.

L'archive ouverte pluridisciplinaire **HAL**, est destinée au dépôt et à la diffusion de documents scientifiques de niveau recherche, publiés ou non, émanant des établissements d'enseignement et de recherche français ou étrangers, des laboratoires publics ou privés.



A multidisciplinary model for floorplan design

Journal:	<i>International Journal of Production Research</i>
Manuscript ID:	TPRS-2006-IJPR-0274.R1
Manuscript Type:	Original Manuscript
Date Submitted by the Author:	21-Jun-2006
Complete List of Authors:	del Rio-Cidoncha, Maria; University of Seville, Departamento de Ingeniería Gráfica Palacios, Juan; University of Seville, Departamento de Ingeniería Gráfica Iglesias, Juan; University of Seville, Applied Physics III
Keywords:	FACILITY LAYOUT, EXPERT SYSTEMS, ROUTING
Keywords (user):	Slicing-trees, Architecture and Industry



A multidisciplinary model for floorplan design

Gloria del Río-Cidoncha¹, Juan Martínez-Palacios¹ and J.Eugenio Iglesias²

¹ Departamento de Ingeniería Gráfica de la Universidad de Sevilla, Escuela Superior de Ingenieros, Av. de los Descubrimientos s/n, 41092 Sevilla (SPAIN), +34954486160, cidoncha@esi.us.es.

² Corresponding author: Departamento de Física Aplicada III de la Universidad de Sevilla, Escuela Superior de Ingenieros, Av. de los Descubrimientos s/n, 41092 Sevilla (SPAIN), +34954488130, jeig@kth.se.

The aim of this work is to develop and implement a model for facility layout design. The first step will be to study the traditional process of positioning, locating or distributing the different facilities, which will be done with the help of slicing trees. Afterwards, the connections between the facilities will be handled, looking for the shortest path that communicates them all, by the means of an expert system. Finally, the orientation of the original surface will be treated, using rules from Feng Shui. These three aspects and their different techniques will be integrated into a single application, joining as well the knowledge and experience from architects and engineers.

The space distribution algorithm of the application itself provides excellent results. Apart from that, the application considers the routing problem, especially important in Architecture (not so important in industrial plan design, when there are no walls between facilities). The application also considers the orientation of the surface, which contributes to improve the comfortability of the building and power saving. The main advantage of the application is that, while being a good tool for solving the facility layout problem, it also considers the routing and orientation of the building.

Keywords: architecture and industry; layout optimization; slicing trees; expert system; routing.

1. State of the art in floorplan design

The general design process is explained in first place in this section. Afterwards, the different approaches to the floorplan problem by engineers and architects are reviewed. Finally, the different methodologies for floorplan generation and solution optimization techniques are also reviewed. The goal of the design process is to get a description of a product or service satisfying certain needs and wishes. Independently of the way in which the process is characterized and the type of product or service, the stages depicted in figure 1 are always present.

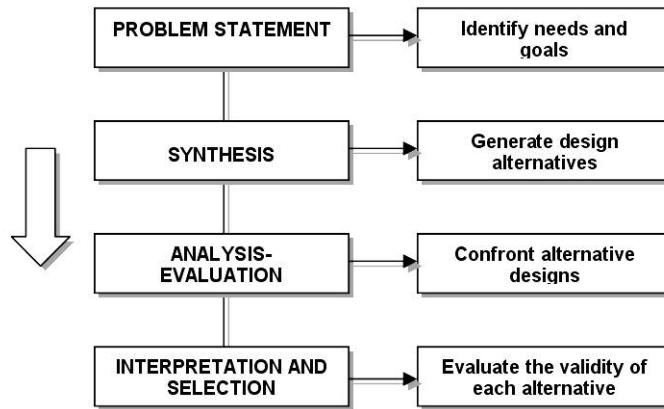

Figure 1: Stages in the design process

In the engineering field, different strategies to solve the implantation problem have arisen along time. The most important ones are, in chronological order: Inmer (1950)[1], Buffa (1955)[2], Muther [3] and Reed (1961) [4], Nadler(1965) [5] and Apple (1977)[6]. The most famous one is Muther, the author of SLP (Systematic Layout Planning), which has been the most widely used method until today. SLP is a common choice for solving facility layout problems, independently of their nature: industrial plants, hospitals, offices, shopping malls, etc.

In Architecture, architectonic composition is defined as the search of physical layouts or organizations that reach certain goals while keeping some restrictions (Coyne 1988 [7]). In figure 2, the architectonic conception processes from the last decade are compared with the traditional methodology. As it can be noticed, the structure of the process remains the same, although all the stages are nowadays computer-assisted.

Traditional	Functional scheme	Design by hand	Coordinate dimensions
Lebahar [17]	Architectonic design	Search of the architectonic object	Construction model
Quintrand [18]	Intention	Project	Realization
Coyne [7]	Adimensional stage	Connectivity and control requirements	Dimensional stage
Coiné and Gero [33]	Functional scheme stage	Sketch stage	Dimensional stage
Seed [20]	Architectonic programming	Schematic layout design	Schematic configuration design

Figure 2: Strategies of architectonic composition, from [8].

A comparison of the solutions to the composition problem, starting from the different visions engineers and architects have from it, is performed here. In Architecture, the design process has been a traditionally debated matter. Several different theories and thinking ways coexist. In Engineering, on the other hand, there has been a methodological discussion about the implantation problem and from there on a general acceptance of the SLP method. Both disciplines differ clearly in the goals to achieve and in the number of solutions, too. As a common factor, it can be stated that the three design stages in the architectonic composition process are the same as in the traditionally considered in industrial design (figure 3).

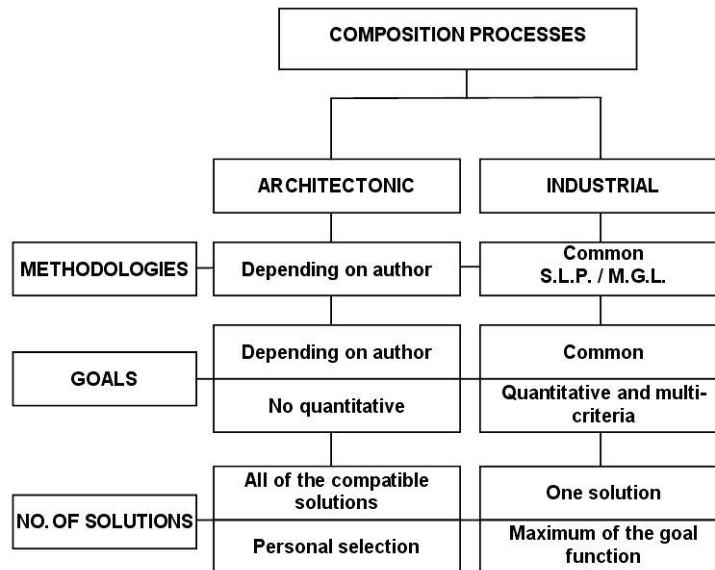

Figure 3: Comparison of composition processes.

The aim of layout generation methods (LGM) is not only to exhaustively list all the solutions that accomplish the requirements, but also to act as an initial filter. There are three different classifications. First of all, depending on the the cost function. Multi-criteria techniques, being unanimously accepted nowadays, are the most important ones, but with several different formulations depending on the author. Second of all, depending on the way of generating the solution: starting from a previous one (improvement methods) or creating a new possible one (construction methods). The third criterion that has been utilized in order to classify the methods is the way of locating the activities, an aspect that is closely related to the mathematical description of the problem. There are three different categories: methods based on discrete techniques, methods that use an analytic formulation of the problem, and methods based on partitioning an initial domain through slicing algorithms. The numerous techniques that are currently utilized for selecting solutions are presented in figure 4. The different origins and authors that used them first for floorplan design are shown in the same figure.

Exact methods	Mathematical formulation	Gilmore [21]
General methods	Computer-assisted techniques	Armour y Buffa [16]
Lattice theory	Planar and dual lattices	Buffa [2]
Simulated Annealing	Random search based on simulating the cooling down process of a metal	Kirpatrick, Gelatt and Vecchi [22]
Tabu Search	Evaluating solutions with tabu conditions and memory from previous operations	Glover [34]
Genetic algorithm	Darwin's evolution theory	Tam [14]
Fuzzy Logic	Fuzzy set theory	Grobelyny [23][24]
Artificial intelligence	Emulation of human thinking with a computer	Akin [25]

Figure 4: Techniques for optimizing solutions, from [8].

2. Techniques in the proposed methodology

Everything that is required to implement the proposed methodology is described in this section. In first place, slicing trees and their applications on floorplan design will be explained, as well as their applications to very large scale integration circuits (VLSI) and, in particular, to an advanced PLAYOUT [9] system. Such a system has worked as a reference for the method proposed in this work. Afterwards, Feng Shui (an oriental discipline for adequation and harmonization of the environment) and its applications to architectonic design will be explained. In third place, as an intrinsic application of artificial intelligence, the known methods for looking for the trajectories that interconnect two points will be enunciated.

2.1 Slicing trees

Trees are a method of representing the arrangement of facilities on a certain floor. There are two different types of trees that are utilized: cut trees and slicing trees. Cut trees are an older technique in which the initial surface is not considered until the final separation is made. When using slicing trees, one starts from the initial geometry and recursively divides the surface with cuts in perpendicular directions. They admit a code for the cut operations, as shown in figure 5.

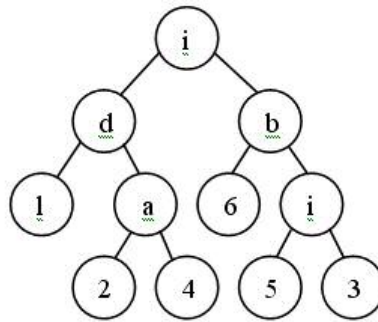

Figure 5: Character array: idal24b6i53.

Slicing trees constitute structures from which layout families can be generated. This tree-shaped structures are organized in internal nodes, which characterize the partitioning cuts, and external nodes, which represent the layout spaces. The structure of a slicing tree must be designed in such a way that it shows the proximity requirements between related activities, clustering those ones between which there is a large flow of materials. The hierarchic grouping process is represented in a diagram called dendrogram (figure 6).

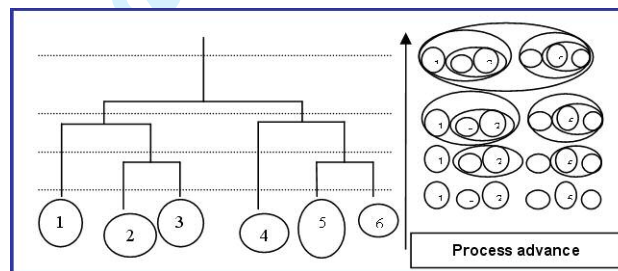

Figure 6: Activity clustering.

2.1.1 VLSI circuit design with Playout

An integrated circuit is constituted by a board made out of silicon which is divided into smaller regions that, thanks to special chemical processes, have different conducting properties. In the case of VLSI technology, the component density is huge, with millions of combinations between conducting, commuting and dielectric cells in a small integrated-circuit wafer. The integrated circuit design problem includes the following variables: the elements to be integrated on the board, their areas and the required connectivity between them. Two restrictions are considered: minimizing the total board area and keeping adequate response times between elements.

In floorplan design, the matter is how to distribute certain facilities, each one with a certain surface, on a given floor, knowing that there is a need for some spaces to be close to other ones. Possible restrictions on areas and distances between them must also be considered. If both problems are analyzed, a clear analogy can be observed. The electronic components are equivalent to the facilities. The board is analogue to the available floor. The connectivity requirements between circuit components are equivalent to the proximity requirements between rooms or departments.

This similarity makes it possible to utilize integrated circuit techniques to solve the floorplan problem. In this work, a procedure whose initial purpose was to design VLSI

1
2
3 layouts is used. This design system, which is computer assisted, is called PLAYOUT
4 [9], and was created at University of Kaiserslautern (Germany) in the Computer Science
5 Department by professor Zimmerman's group in 1995. It is a hierarchic system with a
6 top-down methodology. PLAYOUT consists of: the MIMOLA software system (MMS),
7 the schematic input, the distributor, the shape function generator (SFG), the chip planner,
8 the cell synthesizer and the chip synthesizer.
9

10
11 The chip planner is the central tool. It carries out two independent tasks: locating and
12 wiring. Wiring is the calculation of the minimum layout between the cells. Locating is
13 the topology determination, which is calculated with slicing trees. Its goals are to
14 minimize the net length and to avoid cell stretching. The locating is divided into three
15 stages:
16

- 17 · Partitioning: separating different groups of activities in the tree. Different algorithms
18 can be used: cluster, mincut, ratio-cut and inplace.
- 19 · Orienting: deciding if the separation is made by an horizontal or vertical line.
- 20 · Ordering: decide whether to place to the left or to the right, if the cut is vertical, or up
21 or down, if it is horizontal.

22 23 24 25 26 27 28 29 **2.2 Feng Shui as an architectonic design tool**

30
31 Feng shui is the taoist science and art of living in harmony with the environment. The
32 Earth is seen as a permanent source of energies, that must flow acted upon by basic
33 principles. In order to find them, an orderer work sequence must be followed. This
34 sequence starts with analyzing the shape of the floor and the contour of the building,
35 and then studying the orientation and distribution of the modules in each floor.
36
37

38 39 40 *2.2.1 Shape analysis*

41
42 Shape analysis is the most important aspect in residential Feng Shui studies. It is
43 necessary that the floor and its contour are proportioned to the building. The election of
44 a contour shape for a flat or house depends on three factors: stability, balance and
45 uniformity. Stability is created when, in a building, no floor is much bigger than the
46 other ones. A floor is balanced when its shape is not irregular. Uniformity is defined as
47 the lack of ridges and hard structures.
48
49

50 51 52 *2.2.2 Floor orientation and distribution*

53
54 In order to study the layout and orientation of modules on the floor of a house, the
55 geomantic chart is utilized. It provides a distribution in harmony with the environment,
56 and that harmony is transmitted to the inhabitants, contributing to their well-being. The
57 process starts from the building year in the Chinese calendar. Depending on it, one of
58 the Nine Cycles charts is picked. Numbers are then obtained for every box in the chart,
59 and an orientation is finally provided by the geomantic compass.
60

Feng Shui finishes here. It is now the architect's task to apply his knowledge to the information provided by Feng Shui to design different floorplans for the studied house or flat.

2.3 Route search as a problem within Artificial Intelligence

Finding the shortest way between two points in a network [10] is the purpose of methods that look for the best route. If the shortest way beginning from a certain point S and finishing in another one G is to be found, the most obvious strategy is to consider all the possible trajectories. If they are represented, a search tree is obtained. Every leaf in the tree represents a route, and the branches connect routes to single-step route extensions. Figure 8 shows a search tree that represents the possible paths from the initial leaf in figure 7.

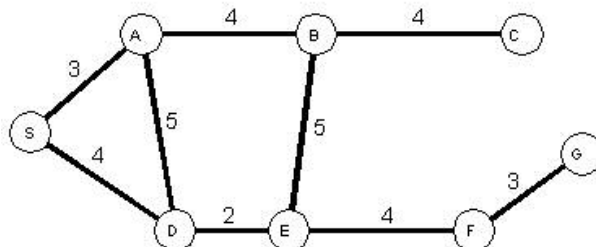

Figure 7: Basic search problem.

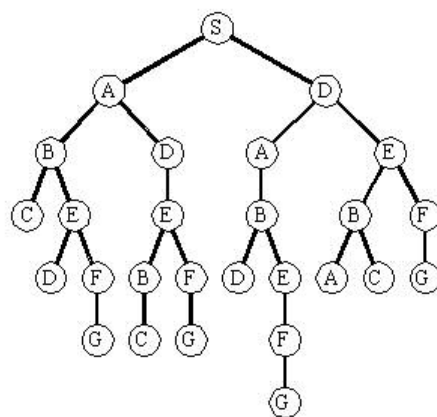

Figure 8: Search tree from the problem in figure 7.

A disadvantage with search trees is that their size grows exponentially. There are search methods that try to minimize the amount of checked paths (Breadth-first search, Depth-first search, etc). But there are also shortest path search methods, which try to solve the problem of finding the shortest path between two points. There are several proposed methods:

- British Museum: all the possible paths are found and the best one selected. It is a good method when the tree is small.

- Branch-and-bound search: partial trajectories are studied and the shortest one chosen. This path is extended in all the possible ways and is studied again. This is useful when the tree is large.
- Subestimation incorporation: hypothesis about the remaining distance to the destination are made.
- Dynamic programming: improves branch-and-bound, suppressing redundant partial trajectories.
- A*: combines dynamic programming and subestimation incorporation.

3. Development of a method for solving the floorplan design problem

There are three necessary steps to make a floorplan design. In the first one, the relationships between different modules, their distribution or location, are established. In a second step, the corridors that communicate the facilities with each other in the most simple and fast way are found. This task is known as routing. In the last step, the spaces are geographically oriented.

For the locating problem, slicing trees were used, extending a technique for VLSI circuits to the floorplan design problem. For the routing problem, an expert system based on rules for production was chosen as the most appropriate for the functional requirements. For the orientation problem, a computer assisted numerical method was used for handling the recommendations provided by Feng Shui. This three modules are synthesized in the proposed CEF methodology, where CEF stands for Cut-Expert-Feng Shui.

3.1 Floorplan distribution or locating

It is important to bear in mind that floorplan design consists of “ordering in the most efficient way certain spaces between which certain interactions exist: flow of materials, resources or information” [11]. Some criteria must be set in order to evaluate which alternative is the best one. These criteria aim at maximizing habitability and beauty in Architecture and at maximizing efficiency and minimizing costs in Engineering.

3.1.1 Problem statement

In general, the starting point of the floorplan design problem consists of:

- A domain floor D with a given geometry and area, $D(A)$.
- The spaces or activities to distribute, with area a_i and geometry $D_i(a_i)$.
- Proximity requirements between certain spaces or activities, know as relational intensities w_{ij} .

The goal is to minimize the total relational cost the system:

$$C = \sum_{i=1}^m \sum_{j=1}^m w_{ij} d_{ij}$$

while keeping the area under the limits of the original floor:

$$\sum_{i=1}^m a_i \leq A$$

The distance d_{ij} is the one between the centres of gravity of the activities i and j . Moreover, the following constraints must also be satisfied:

$$\begin{aligned} q_{i,\min} &\leq q_i \leq q_{i,\max} \\ 0 &\leq o_i \leq o_{i,\max} \\ i, j &= 1, 2, \dots, m \end{aligned}$$

where q_i is the aspect ratio of activity i : length divided by width. Setting a limit for this value [8] prevents the algorithm from generating too elongated spaces, which are especially inappropriate in Architecture. On the other hand, o_i is the dead area ratio of activity i . This parameter indicates the existence of occupied areas in the initial domain floor D and the distortion this fact causes on the shape of the solution.

3.1.2 Utilized methodology

The proposed CEF methodology divides the process into three steps: partitioning, orienting and ordering, which were described in section 2.1. For partitioning the initial rectangle, as CEF can handle just this type of geometry, the ratio-cut algorithm was used because it gives a large importance to balancing the areas to both sides of the cut. Figure 9, in which A_i and B_i are the subgroups of rooms or activities created by the cut, shows that the design parameter for this algorithm is the ratio between the weight of a cut and the product of the sizes of the sub-trees. The heuristic of the algorithm is to minimize that parameter. When the value of the parameter is equal for two distributions, the one with a bigger denominator or the one with more similar area is chosen.

For orienting, the Lather method [12] was used (figure 10). It proposes orienting the cut so that it is parallel to the shortest side of the partitioned surface. It requires a continuous analysis of the shape of the partitioned surface, so that all the resulting shapes are under control. For ordering, the purpose of the CEF program is to minimize the function that represents the transport cost between spaces, figure 11. All the possible distributions are calculated, and the one that provides the minimum cost function value is spared.

1
2
3
4
5
6
7
8
9
10
11
12
13
14
15
16
17
18
19
20
21
22
23
24
25
26
27
28
29
30
31
32
33
34
35
36
37
38
39
40
41
42
43
44
45
46
47
48
49
50
51
52
53
54
55
56
57
58
59
60

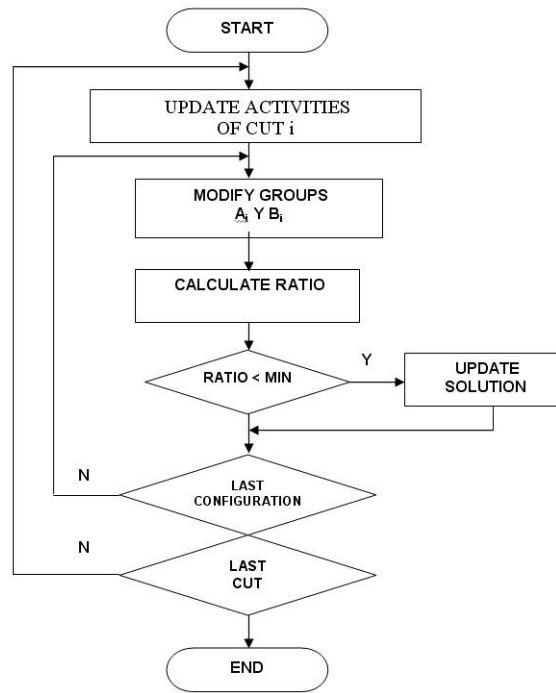

Figure 9: Ratio-cut algorithm.

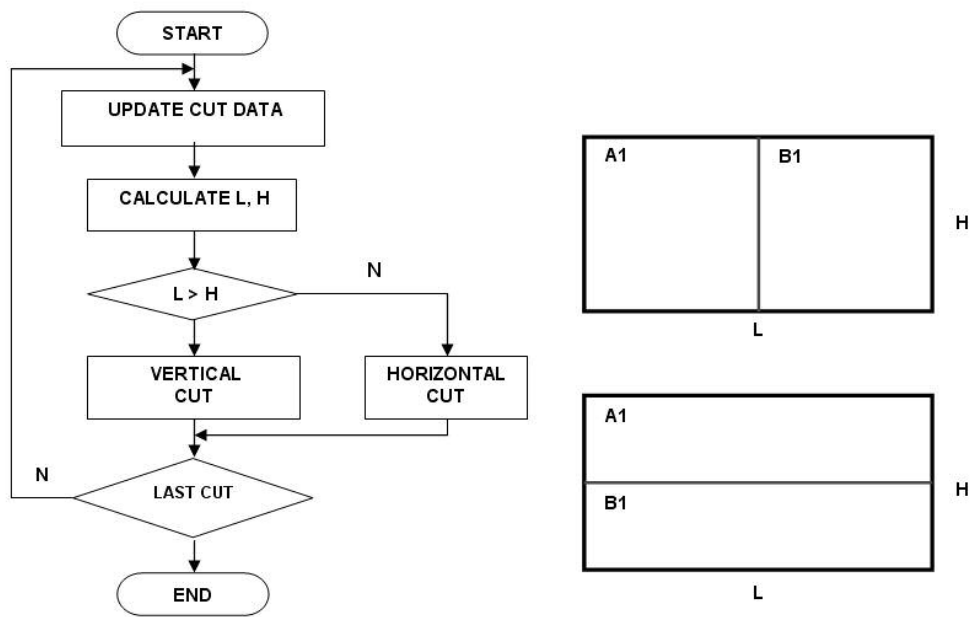

Figure 10: Lather method: spaces with elongated shapes are avoided.

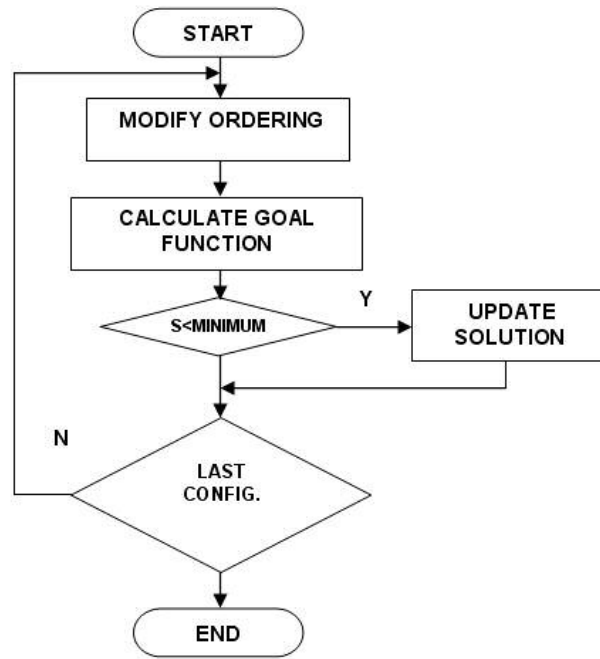

Figure 11: Minimization of the goal function, that is, the sum of distances between the centers of gravity of the related spaces or activities.

3.2 Routing

Once the locating problem is solved, the next step is to find the smallest net that interconnects all the departments or modules. A method for solving this problem has been searched. The algorithm for looking for the tree that provides a minimum laying was adapted, analyzing at the same time the connection between square spaces with equal size and the best way of joining sub-trees that interconnect groups of modules. Synthesizing these three analysis, an algorithm that reaches a local minimum in a reasonable time was obtained. The algorithm will be translated to production rules, so that an expert system for module connection is available.

According to the terms defined in figure 12, the method operates in the following way:

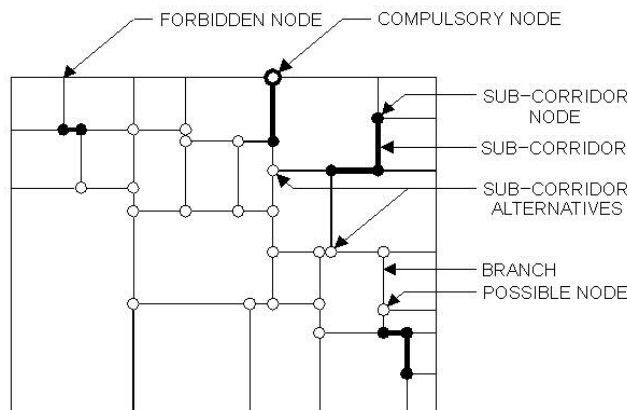

Figure 12: Definition of terms used in the heuristic.

· Mark the nodes which are not desired to be part of any corridor as forbidden. Mark the input node as compulsory.

· Mark the branches that lead to forbidden nodes also as forbidden.

· Look for the nodes that are marked as compulsory or have been configured like that in the process of forbidding nodes or branches. This way there will not be isolated modules.

· Check the different alternatives for sub-corridors and, in the case of any of them having just one alternative, make that node and the branch that communicates it part of the sub-corridor.

· When no more branches can be added, the longest non-forbidden branch is eliminated. Once a branch is discarded, the process continues until all the sub-corridors are merged into one, that connects all the spaces. In this point, a solution has been reached, but it has to be revised in order to look for local improvements (for example, branches that form loops).

3.3 Orientation in floorplan design

The third and last stage of the methodology stage is the orientation. The empirical rules depicted in figure 13, which depend on the type of space and are related to the cardinal points, were obtained from Feng Shui.

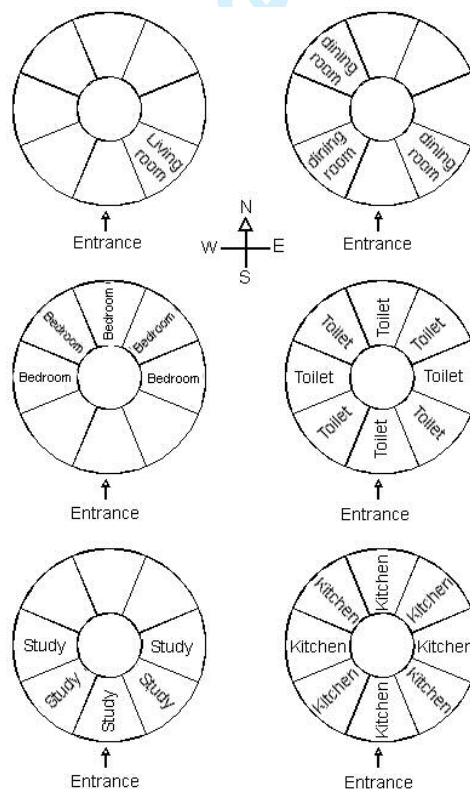

Figure 13: Orientations recommended by Feng Shui.

In order to put together the Feng Shui recommendations on relationships between spaces, a diamond-tipped relational diagram (figure 14) has been used. Capital letters represent the relationships that are directly derived from previously drawn conclusions. Lower-case letters represent the relationships that are introduced from the PAKUA anagram. The A, U and X categories are used in the first case. The rest are used for the inducted categories.

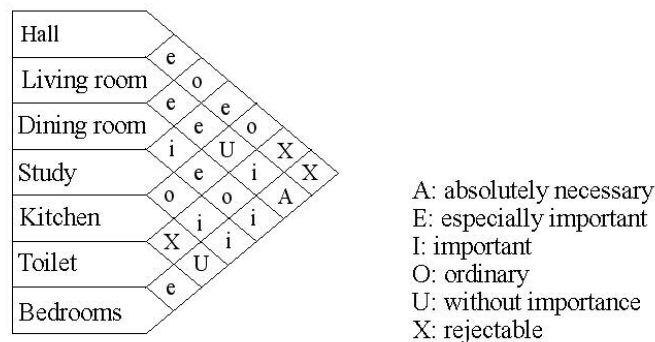

Figure 14: Diamond-tipped relational diagram.

When these recommendations are analyzed, their parallelism with the occidental house conception can be appreciated.

4. Description and analysis of the results

The purpose of this section is to validate the CEF method that has been proposed as a solution to the floorplan design problem, both for industry and architecture, by applying it to different problems that have already been studied by other authors. As the CEF method consists of three modules (locating, routing and orienting) that work independently, their efficiency will be initially tested one by one. A later experiment will test how the system works on the whole.

4.1 Locating module in engineering.

In order to develop the experimental part of the locating module in engineering, the problem posed by Francis and White in 1974 [13] is used. For validating the proposed method, the results will be compared to those from other authors that have studied the same floorplan design problem. The selected methods are

- Francis and White method.
- Kar Yan Tam (KYT) method [14].
- ARBOGEN method [15].

The Francis and White method, based on a CRAFT [16] improvement method, requires an initial solution as starting point. KYT is a hybrid method, based on genetic algorithms and slicing trees. It utilizes clustering techniques to generate a dendrogram that represents the structure of the tree. ARBOGEN is also a hybrid method based on genetic algorithms and slicing trees. As opposed to KYT, it also admits different slicing

tree structures, applying the genetic algorithms in a double level in order to look for the most adapted species. The different results are presented in figure 15.

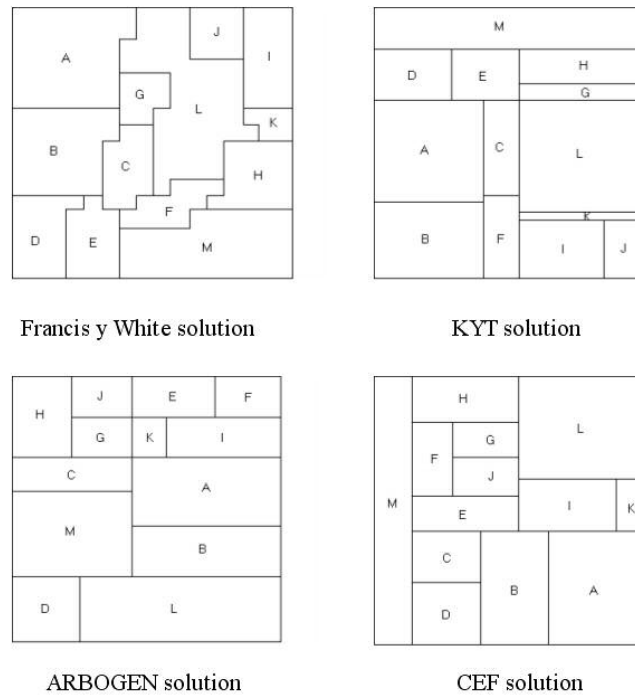

Figure 15: Obtained results.

The results are compared according to the following criteria:

- Resulting geometric shapes: the comparison with the Francis and White solution is not possible, as its geometry is not rectangular. The other represented solutions use slicing trees and have rectangular geometries. In these cases it is interesting to calculate the length-width ratio for the spaces, setting certain limits for acceptable values. This ratio indicates the quadrature of the spaces. The mean values are shown in table 1.
- Transport costs: to make a quantitative comparison, they were calculated by multiplying each flow by the corresponding transport cost and by the distance between each pair of activities. The sums of all the partial costs are shown in table 2. CEF 1 is exactly the same as CEF but with binary relational intensities.

Method	KYT	ARBOGEN	CEF
Mean ratio	3.39	2.04	1.75

Table 1: Mean quadrature ratio.

Method	CRAFT	KYT	ARBOGEN	CEF-1	CEF-2
Cost	4521.5	6324.2	7470.5	4379.6	4246.2

Table 2: Transport costs.

It can be appreciated in table 2 that the distribution obtained with the method proposed in application 1 achieves a transport cost 17.7% and 41.3% less than KYT and ARBOGEN, respectively. Application 2 achieves an even lower cost, showing the importance of utilizing integer relational intensities in the design program, as the approximation to the real problem is larger.

4.2 Locating module in architecture

It is important to emphasize in first place the impossibility of quantizing aesthetic and composition factors, such as habitability, balance and beauty, which are important goals of an architectonic distribution. Moreover, as opposed to what happens in engineering, there are several strategies to approach the floorplan design problem. This review, that is the design process itself, shows the composing procedure (the main discussion point) and its formalization and conceptualization (most of the researchers' aim).

There are two differentiating aspects between the different models: the number of solutions that are obtained and kind of goal function (figure 16). Most of the architecture-specific applications provide all the possible solutions, leaving the definitive choice in the professional's hands. It is in the goal function where more diversity between methods can be found, even if many researches focus on optimizing dimensional aspects (such as wall lengths, areas...), summed up in different parameters. Fewer try to maximize the proximity between spaces with related needs, single goal for every industrial procedure.

Number of obtained solutions	Single solution	Roth [35], Del Río [8]	
	All possible solutions	Ligett [36], Coyne [7], Canivell [26], Kovács [27], Maculet [28], Schwarz et al [29] [30], Flemming et al [20], Charman [31], Smith [32], Medjdoub [19].	
Goal function kind	Geometric	Area	Ligett [36], Roth [35]
		Length	Canivell [26], Medjdoub [19]
	Relational	Del Río [8]	
	Other	Coyne [7], Kovács [27], Maculet [28], Schwarz et al [29] [30], Flemming et al [20], Charman [31], Smith [32],	

Figure 16: Different approaches depending on the number of solutions and the kind of cost function.

4.3 Routing module

The problem of connecting a set of spaces, where each one can be connected to the net by any point of its perimeter, is a rather particular problem, and there are not many studies or resolution algorithms about it, as its most important application is floorplan design. That is why programs outside floorplan design had to be searched in order to compare the routing module application. Another field in which trees that interconnect

points are searched is microelectronics. In this context, the ORCAD-PCB program is presented. It is a commonly used program for printed circuit wiring. Comparing both solutions, it is observed that search times are in average 62% longer in CEF than in ORCAD-PCB. On the other hand, CEF takes advantage of this extra time to obtain a shorter solution (4.5% of the length of the net in average).

4.4 Complete method

All the abilities of the application will now be used at the same time: locating the spaces, orientating the floor and obtaining the corridor that communicates all the modules with minimum length. In order to evaluate the results, the floor of an already built house is compared to the solution from the CEF program. The construction of the studied house was finished in 1994. It was designed by the architect Jaime López de Asiaín y Martín. Its floor is shown in figure 17. The solution provided by the CEF method is shown in figure 18.

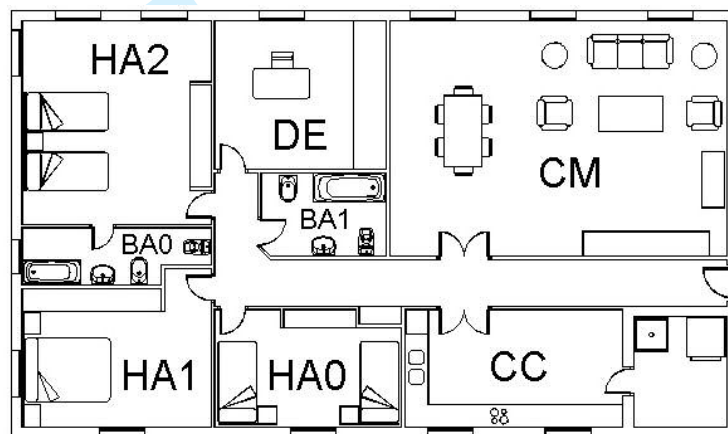

LEGEND:
 HAX = bedrooms BAX = bathrooms CM = living room
 DE = office CC = kitchen

Figure 17: The floor of the studied house.

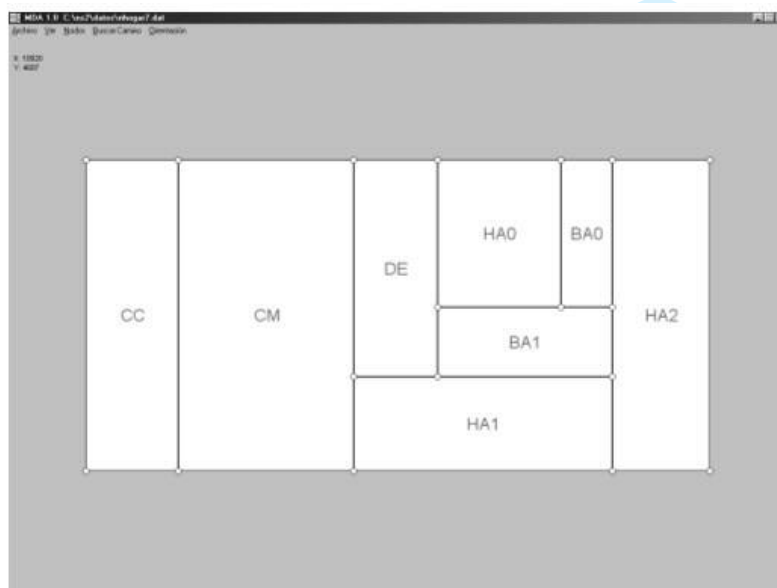

Figure 18: Solution with CEF.

The similarity with the real floor is large. Considering the locations of the rooms, only the kitchen - dining-room cut, which is done by a vertical wall, is different to the separations on the real floor. This is due to the weak relationship established between the kitchen and the other rooms by Feng Shui, which makes the separation between the kitchen and the other rooms the first cut to be performed.

The routing module of the application was employed to establish the path that communicates all the rooms. The result is shown in figure 19.

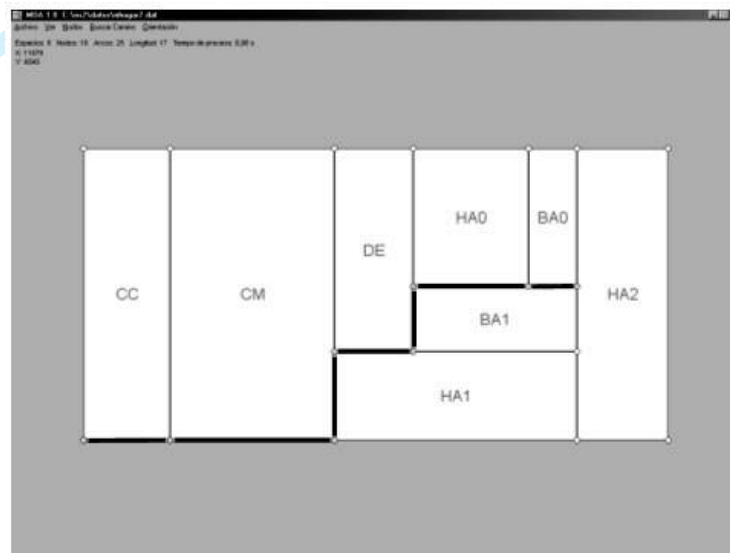

Figure 19: Routing.

Even when an implantation can be oriented without performing its routing, the best disposition (related to the cardinal points) among those ones that are possible is chosen according to Feng Shui rules. As it can be appreciated in figure 20, the program shows the geographic north direction and reports the amount of degrees that the floor should be rotated with respect to the one shown on the screen.

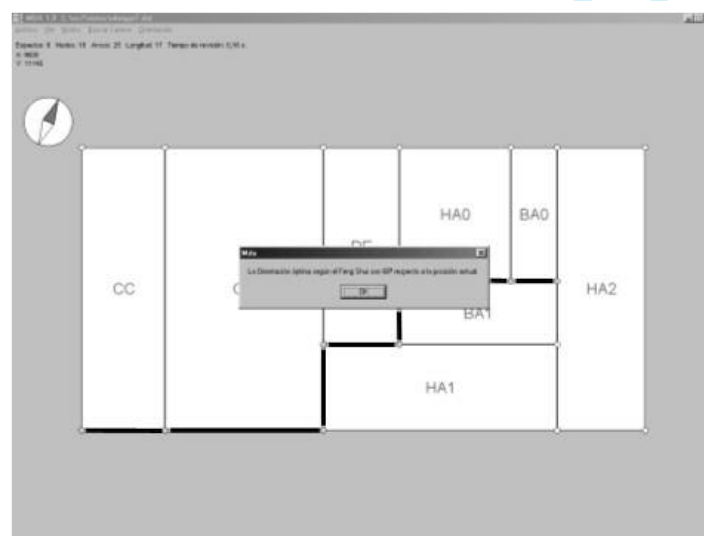

Figure 20: Solution from figure 19 oriented.

5. Conclusions and future work

The proposed CEF methodology tackles in an integrated way the three aspects that determine the configuration of a floorplan: location, routing and orientation. The handling is the same for industrial and architectonic floors: a single application with common inputs and a single output is used. The modular configuration that was chosen for the application contributes especially to this fact.

Reviewing the conclusions for each module, it must be emphasized that, for the locating module, advantage was taken of the similarity with integrated circuit design. A procedure with slicing trees was utilized, leading to a heuristic that looks for the optimal solution for the distribution with computer-assisted techniques. The methodology allows to easily formulate a multi-criteria goal function. The main disadvantage with the employed slicing tree techniques is that they lead to elongated spaces, but the ratio-cut algorithm in cut selection contributes to the geometric control of the solutions. As a consequence of the two previous aspects, the obtained layouts have a modular configuration. Finally, it can be concluded that this module provides better solutions than the other known locating methods.

Concerning routing, the system provides high quality solutions, even if they are approximations, as it has been shown in the experiments. The main characteristic of the module is its flexibility: the capacity of adapting to different requirements. This is derived from two aspects: the utilized production rules and the division of the module into three parts that work independently from each other. Finally, regarding orientation, it has been shown how Feng Shui principles, taken out from bibliography, can be used through a routine written in C++.

CEF is currently being successfully used by the “Miguel Ángel López y Asociados” architecture studio in Seville (Spain). It is also utilized by “Ayesa”, a powerful Spanish company that designs and builds industrial plants. It is even used experimentally by professor Laura Roa at University of Seville in order to develop a teleassistance system for nephrology (“NEFROTEL”).

Regarding the future work, it is important to mention that only rectangular floors have been studied in this article. The software could be updated so that it could handle irregular shapes. It could also be extended to design distributions along different floors, including the necessary spaces for stairs and elevators. Finally, it would also be desirable to be able to define a relational intensity matrix that represents asymmetric flows of materials. This would be especially important in industrial plants, where the flow of materials from room A to room B can be very different from the flow from room B to room A.

REFERENCES

- [1] Immer JR. Layout planning techniques. Mc Graw Hill, New York, 1950.
- [2] Buffa ES. Sequence analysis for functional layouts. *The Journal of Industrial Engineering*, pages 12–25, March 1955.
- [3] Muther R. Systematic Layout Planning. Industrial Education Institute, Boston, 1961.
- [4] Reed R. Plant Layout: Factors, Principles and Techniques. Homewood, IL, 1961.
- [5] Nadler G. What systems really are. *Modern Materials Handling*, 20(7):41–47, 1965.
- [6] Apple JM. Plant layout and material handling. John Wiley and Sons, New York, 1977.
- [7] Coyne RD. Logic models of design. Pitman Publishing, London, 1988.
- [8] Del Río-Cidoncha MG. A model for architectural design layout. PhD thesis, School of Industrial Engineering of University of Seville (Spain), 2002.
- [9] Zimmerman G. A hierarchical design system. Proceeding IFIP, 1989.
- [10] González A. Sistema experto para minimizar los recorridos en una distribución en planta. Master's thesis, ES Ingenieros, Universidad de Sevilla, 1999.
- [11] Tompkins JA; White JA. Facilities Planning. Wiley and Sons, New York, 1996.
- [12] Lengauer T. Combinatorial Algorithms for Integrated Circuit Layout. Wiley and Sons, Chichester, 1990.
- [13] Francis RL; White JA. Facility layout and location, an analytical approach. Prentice-Hall Inc, Englewood Cliffs, New Jersey, 1974.
- [14] Tam KI. A simulated annealing algorithm for allocating space to manufacturing cells. *International Journal Production Research*, 30(1):63–87, 1992.
- [15] Santamarina Siurana MC. Métodos de optimización en la generación de distribuciones de plantas industriales mediante la aplicación de algoritmos genéticos y técnicas basadas en árboles de corte. PhD thesis, Universidad Politécnica de Valencia (Spain), 1995.
- [16] Armour GC; Buffa ES. A heuristic algorithm and simulation approach to relative location of facilities. *Management Science*, 9(2):294–309, 1963.
- [17] Lebahar JC. Le dessin d'architecte. Roquevaire: Parenthese, Marseille, 1983.
- [18] Quintrand P et al. SLa conception assistée par ordonnateur en Architecture. Hermes, Paris, 1985.
- [19] Medjdoub B. Methode de conception fonctionnelle en architecture: une approche CAO basée sur les contraintes: ARCHIPLAN. PhD thesis, Ecole Centrale de Paris, 1996.
- [20] Flemming U et al. Seed-proyect. *Journal of Architectural Engineering*, 1:147–203, 1995.
- [21] Gilmore PC; Gomory RE. Multistage cutting stock problems of two and more dimensions. *Operation Research*, 13:94–120, 1963.
- [22] Kirkpatrick S; Gelatt CD; Vecchi MP. A heuristic algorithm and simulation approach to relative location of facilities. *Optimization by simulated annealing*, 220(4598):671–680, 1983.
- [23] Grobelny J. On one possible fuzzy approach to facilities layout problems. *International Journal Production Research*, 25(8):1123–1141, 1987.
- [24] Grobelny J. The fuzzy approach to facilities layout problem. *Fuzzy Sets and Systems*, 23:175–190, 1987.
- [25] Akin O. Models of architectural knowledge: an information processing view of architectural design. PhD thesis, Carnegie-Mellon University, Pittsburgh, 1979.
- [26] Canivell J. Procedimiento interactivo para la generación y optimización de organizaciones espaciales en planta. PhD thesis, Universidad de Sevilla, 1986.
- [27] Kovacs LB. Knowledge based floor plan design by space partitioning: A logic programming approach. *Artificial Intelligence in Engineering*, 6(4):162–185, 1991.
- [28] Maculet R. Représentation des connaissances spatiales (Algèbre de Manhattan) et raisonnement spatial avec contraintes. PhD thesis, Université Paris 6, 1991.
- [29] Schwarz A; Berry DM; Shaviv E. On the use of the automated building design system. *Computer Aided Design*, 26(10):747–762, October 1994.
- [30] Schwarz A; Berry DM; Shaviv E. Representing and solving the automated building design problem. *Computer Aided Design*, 26(9), September 1994.
- [31] Charman P. Gestion des contraintes géométriques pour l'aide à l'aménagement spatial. PhD thesis, l'École Nationale des Ponts et Chaussées, 1995.
- [32] Smith I. Creative design objects from cases for interactive spatial composition. 4th International Conference on Artificial Intelligence in Design (AID 96), Stanford University, 1996.
- [33] Coyne RD; Rosenman MA; Radford AD; Balachandran MB; Gero JS. Knowledge-Based Design systems. Addison-Wesley Publishing Company, Reading, Massachusetts, 1990.
- [34] Glover F. Tabu search: tutorial. Technical report, Center for Applied Artificial Intelligence, University of Colorado, 1989.
- [35] Roth J; Hashimshony R; Wachman A. Turning a graph into a rectangular floor plan. *Building and Environment*, 17(3):163–173, 1982.
- [36] Ligett RS; Mitchel WJ. Optimal space planning in practice. *Computer Aided Design*, 13(5):277–288, 1981.