



HAL
open science

Uniqueness of the perfect fusion grid on Z^d

Jean Cousty, Gilles Bertrand

► **To cite this version:**

Jean Cousty, Gilles Bertrand. Uniqueness of the perfect fusion grid on Z^d . Journal of Mathematical Imaging and Vision, 2009, 34 (3), pp.291-306. 10.1007/s10851-009-0147-0 . hal-00511818v2

HAL Id: hal-00511818

<https://hal.science/hal-00511818v2>

Submitted on 26 Aug 2010

HAL is a multi-disciplinary open access archive for the deposit and dissemination of scientific research documents, whether they are published or not. The documents may come from teaching and research institutions in France or abroad, or from public or private research centers.

L'archive ouverte pluridisciplinaire **HAL**, est destinée au dépôt et à la diffusion de documents scientifiques de niveau recherche, publiés ou non, émanant des établissements d'enseignement et de recherche français ou étrangers, des laboratoires publics ou privés.

Uniqueness of the perfect fusion grid on \mathbb{Z}^d

Jean Cousty · Gilles Bertrand

Revised version: April 2009

Abstract Region merging methods consist of improving an initial segmentation by merging some pairs of neighboring regions. In a graph, merging two regions, separated by a set of vertices, is not straightforward. The perfect fusion graphs defined in [J. Cousty et al., “Fusion Graphs: Merging Properties and Watersheds”, *JMIV 2008*] verify all the basic properties required by region merging algorithms as used in image segmentation. Unfortunately, the graphs which are the most frequently used in image analysis (namely, those induced by the direct and the indirect adjacency relations) are not perfect fusion graphs. The perfect fusion grid, introduced in the above mentioned reference, is an adjacency relation on \mathbb{Z}^d which can be used in image analysis, which indeed induces perfect fusion graphs and which is “between” the graphs induced by the direct and the indirect adjacencies. One of the main results of this paper is that the perfect fusion grid is the only such graph whatever the dimension d .

Keywords adjacency relation · region merging · perfect fusion graph · perfect fusion grid · chessboard · line graph · discrete geometry · digital topology · image processing

J. Cousty
Asclepios Research Project, INRIA Sophia Antipolis, France; and
Université Paris-Est, Laboratoire d'Informatique Gaspard-Monge, équipe A3SI, ESIEE, France
E-mail: j.cousty@esiee.fr

G. Bertrand
Université Paris-Est, Laboratoire d'Informatique Gaspard-Monge, équipe A3SI, ESIEE, France
E-mail: g.bertrand@esiee.fr

Introduction

Image segmentation is the task of delineating objects of interest that appear in an image. In many cases, the result of such a process, also called a segmentation, is a set of connected regions lying in a background which constitutes the separation between regions. To define regions, an image is often considered as a graph whose vertex set is made of the pixels of the image and whose edge set is given by an adjacency relation on these pixels. In this framework¹, the regions correspond to the connected components of foreground pixels (see for instance Fig. 1).

A popular approach to image segmentation, called region merging [1,2], consists of progressively merging pairs of regions, starting from an initial segmentation that contains too many regions (see, for instance, Figs. 1a and b). Given a subset S of an image equipped with an adjacency relation, merging two neighboring regions (connected components) of S is not straightforward. A problem occurs when we want to merge a pair of neighboring regions A and B of S and when each point adjacent to these two regions is also adjacent to a third one that we want to preserve during the merging operation. Fig. 1c illustrates such a situation, where x is adjacent to regions A, B, C and y to A, B, D . Thus, we cannot merge A and B while preserving both C and D . This problem has been identified in particular by T. Pavlidis (see [1], section 5.6: “When three regions meet”), and, as

¹ Another framework, popular in image analysis, consists of considering a segmentation as a partition of the image domain where each element of the partition represents a segmented region. Thus the regions are not separated by “background pixels”. As we will see in Section 5, in many cases, this framework also falls in the scope of the present paper.

far as we know, has not been solved in general. A major contribution of [3] is the definition of a merging operation and the study of a class of graphs, called the *perfect fusion graphs*, where such a situation cannot occur.

In 2-dimensional image analysis, two adjacency relations on \mathbb{Z}^2 , called the *4-* and the *8-adjacencies* [5], are commonly used. With the 4-adjacency (resp. the 8-adjacency), each point is adjacent to its 4 (resp. 8) closest neighbors. For instance, the graph in Fig. 1c is induced by the 4-adjacency. As seen above, the two neighboring regions A and B cannot be merged, while preserving all other regions, by removing x and y from the set of black vertices. Thus, in general, the graphs induced by the 4-adjacency are not perfect fusion graphs. Similar configurations can be found with the 8-adjacency. Thus the graphs induced by the 8-adjacency are not perfect fusion graphs either. More generally, the graphs induced by the direct and the indirect adjacencies [5,6], which generalize the 4- and the 8-adjacencies to \mathbb{Z}^d , are not perfect fusion graphs (see Section 6 in [3]).

In [3], we introduce a family of graphs on \mathbb{Z}^d that we call the *perfect fusion grids*, which can be used in image analysis, which are indeed perfect fusion graphs, and which are “between” the graphs induced by the direct and the indirect adjacencies. Let us give an intuitive presentation of these graphs in the two dimensional case. Consider the set \mathcal{C} of all black squares in a chessboard (see Fig. 2). The perfect fusion grid is simply the graph obtained, by setting adjacent any two summits which belong to a same square in \mathcal{C} (see, for instance, the two graphs depicted Fig. 2). Fig. 3a shows a set of regions obtained in this grid thanks to a watershed algorithm [7]. It can be seen on Fig. 3b that the problems pointed out in the previous paragraphs do not exist in this case: any pair of neighboring regions can be merged by simply removing from the black vertices the points which are adjacent to both regions (see Fig. 3b,c). Furthermore, it can be verified on Fig. 2 that any two points which are 4-adjacent are necessarily adjacent for the perfect fusion grid and that any two points adjacent for the perfect fusion grid are necessarily 8-adjacent. In this sense, the perfect fusion grid satisfies the geometric constraint of being “between” the graphs induced by the 4- and the 8-adjacency relation.

One of our main result in this paper (Theorem 21) establishes that the perfect fusion grid is the only perfect fusion graph on \mathbb{Z}^d which is between the direct and the indirect adjacency relations, whatever the dimension $d \in \mathbb{N}_*$. The outline of the paper is the following: we first recall in Section 1 some definitions

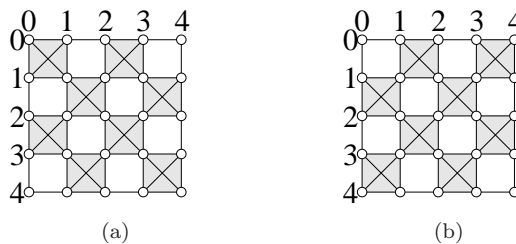

Fig. 2 Illustration of the two perfect fusion grids on \mathbb{Z}^2 . The gray squares constitute subsets of the two chessboard on \mathbb{Z}^2 and the associated graphs are the subgraphs of the perfect fusion grids $(\mathbb{Z}^2, A_{(1,1)}^2)$ and $(\mathbb{Z}^2, A_{(1,0)}^2)$ induced by $\{0, \dots, 4\} \times \{0, \dots, 4\}$.

and properties related to region merging and perfect fusion graphs. Then, in Section 2, we propose a set of definitions and properties to handle cubical grids in arbitrary dimension. Afterward, Section 3 provides a definition of the perfect fusion grids which is based on the notion of a chessboard in \mathbb{Z}^d . In Section 4, we prove the unicity theorem of the perfect fusion grids. Finally, in Section 5, we establish three properties, based on the notion of a *line graph*, which allow us to make a strong link between the framework developed in this paper and the approaches of segmentation based on edges rather than vertices (*i.e.* when the regions are separated by a set of edges). In order to ease the reading, this article² is self-contained.

1 Perfect fusion graphs

1.1 Basic notions on graphs

Let E be a set, we denote by 2^E the set composed of all subsets of E . Let $X \subseteq E$, we write \bar{X} for the *complementary set* of X in E , *i.e.*, $\bar{X} = E \setminus X$. Let E' be a set. The *Cartesian product* of E by E' , denoted by $E \times E'$, is the set made of all pairs (x, y) such that $x \in E$ and $y \in E'$.

We define a *graph* as a pair (E, Γ) where E is a set and Γ is a binary relation on E (*i.e.* $\Gamma \subseteq E \times E$) which is anti-reflexive (for any $x \in E$, $(x, x) \notin \Gamma$) and symmetric (for any x and y in E , $(y, x) \in \Gamma$ whenever $(x, y) \in \Gamma$). Each element of E (resp. Γ) is called a *vertex or a point* (resp. an *edge*). We will also denote by Γ the map from E to 2^E such that, for any $x \in E$, $\Gamma(x) = \{y \in E \mid (x, y) \in \Gamma\}$. Let $x \in E$, the set $\Gamma(x)$ is called the *neighborhood* of x and if $y \in \Gamma(x)$, we say that y is *adjacent to* x . If $X \subseteq E$, the *neighborhood* of X , denoted by $\Gamma(X)$, is the set $[\cup_{x \in X} \Gamma(x)] \setminus X$.

² A part of the results of this paper has been presented, without proofs, in a conference article [8].

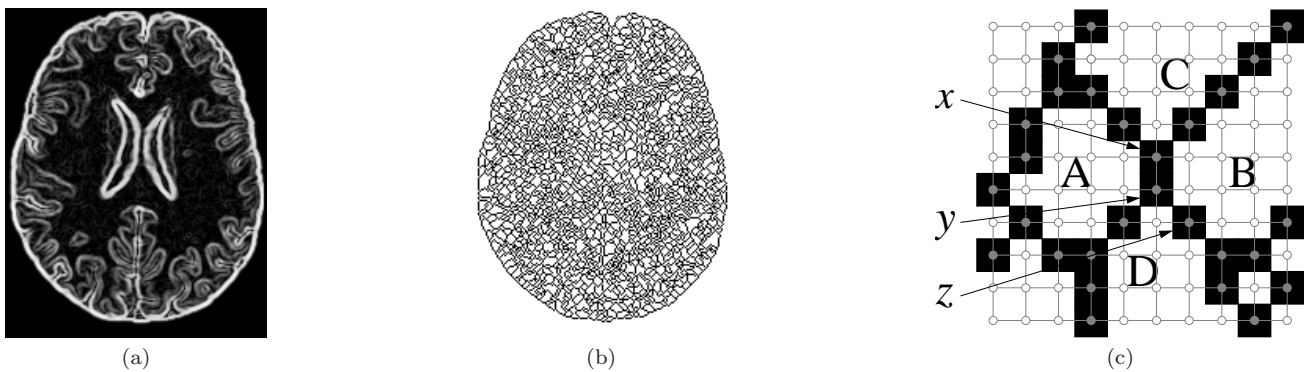

Fig. 1 (a): Original image (cross-section of a brain, after applying a gradient operator). (b): A segmentation of (a) (obtained by a watershed algorithm [4] using the 4-adjacency relation). (c): A zoom on a part of (b); the graph induced by the 4-adjacency relation is superimposed in gray.

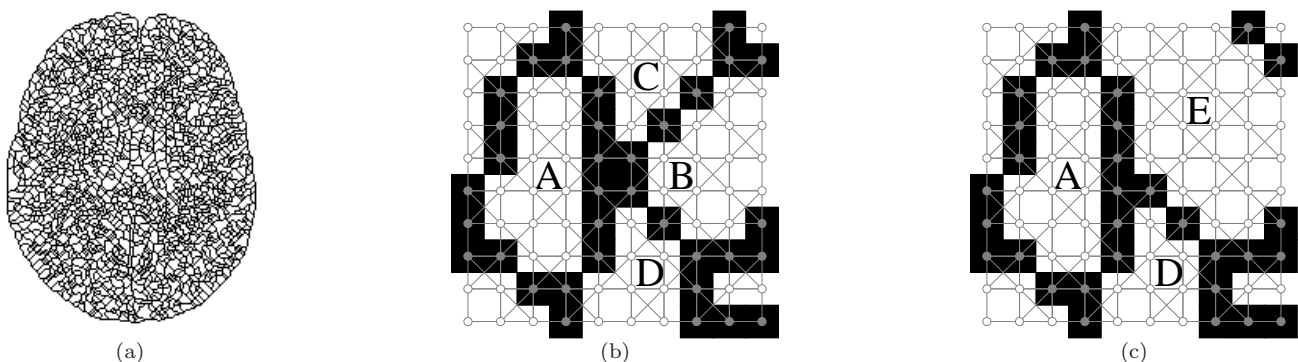

Fig. 3 (a) A segmentation of Fig. 1a obtained on a perfect fusion grid. (b) A zoom on a part of (a); the regions A, B, C and D correspond to the ones of Fig. 1c; the corresponding perfect fusion grid is shown in gray. (c) Same as (b) after having merged B and C to form a new region E.

Let $G = (E, \Gamma)$ and $G' = (E', \Gamma')$ be two graphs, we say that G and G' are *isomorphic* if there exists a bijection f from E to E' such that, for all $x, y \in E$, y belongs to $\Gamma(x)$ if and only if $f(y)$ belongs to $\Gamma'(f(x))$.

Let $G = (E, \Gamma)$ be a graph. Let $S \subseteq E$, the set S is a *clique for G* if any two elements x and y of S are adjacent. A clique S for G is said to be a *maximal clique for G* if, $S = S'$ whenever S' is a clique for G and $S \subseteq S'$.

Let $G = (E, \Gamma)$ be a graph and let $X \subseteq E$, we define the *subgraph of G induced by X* as the graph $G_X = (X, \Gamma \cap [X \times X])$. We also say that G_X is a *subgraph of G* .

Let (E, Γ) be a graph and $X \subseteq E$. A *path* in X is a sequence $\langle x_0, \dots, x_\ell \rangle$ such that $x_i \in X$, $i \in [0, \ell]$, and $(x_{i-1}, x_i) \in \Gamma$, $i \in [1, \ell]$. The set X is *connected* if, for any $x, y \in X$, there exists a path in X from x to y . Let $Y \subseteq X$, we say that Y is a (*connected*) *component* of X if Y is connected and maximal for this property, *i.e.* if $Z = Y$ whenever $Y \subseteq Z \subseteq X$ and Z connected.

Important remark. From now on, when considering a graph $G = (E, \Gamma)$, we always assume that E is

connected and that G is *locally finite*, *i.e.* the set $\Gamma(x)$ is finite for any $x \in E$.

1.2 Region merging and perfect fusion graphs

Consider the graph (E, Γ) depicted in Fig. 4a, where a subset S of E (white and gray vertices) is composed of four regions (connected components). If we replace the set S by, for instance, the set $S \cup T$ where $T = \{x, y, z\}$, we obtain a set composed of three regions (see Fig. 4b). We can say that we “merged two components of S through T ”. This operation may be seen as an “elementary merging” in the sense that only two regions of S were merged while all other regions of S were preserved. On the opposite, replacing the set S by the set $S \cup T'$, where $T' = \{w\}$ (see Fig. 4c), would merge three components of S . This section recalls the definitions introduced in [3] related to such merging operations in graphs. Then, we remind the definition of the perfect fusion graphs, which are the graphs in which any two neighboring regions can be merged through

their common neighborhood while preserving all other regions.

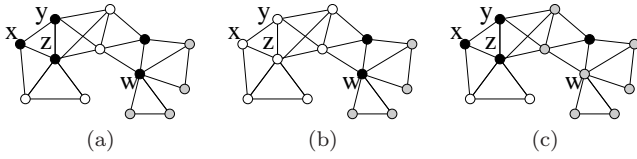

Fig. 4 Illustration of merging. (a) A graph (E, Γ) and a subset S of E (white and gray points). (b) The white and gray points represent a subset $S \cup T$ where $T = \{x, y, z\}$. (c) The white and gray points represent a subset $S \cup T$ where $T' = \{w\}$.

Let (E, Γ) be a graph and let $S \subseteq E$. Let A and B be two distinct components of S and $T \subseteq \bar{S}$. We say that A and B can be merged (for S) through T if A and B are the only connected components of S adjacent to T and if $A \cup B \cup T$ is connected.

In other words (see Property 21 in [3] for a formal proof), the two regions A and B can be merged through T if and only if $A \cup B \cup T$ is a component of $S \cup T$. More precisely, they can be merged if and only if the components of $S \cup T$ are the same as the components of S except that A and B are replaced by $A \cup B \cup T$.

For instance, in Fig. 4a the two white components can be merged through $\{x, y, z\}$ but the two gray components cannot be merged through $\{w\}$.

Let (E, Γ) be a graph, $S \subseteq E$, and let A and B be two distinct connected components of S . We set $\Gamma(A, B) = \Gamma(A) \cap \Gamma(B)$ and we say that $\Gamma(A, B)$ is the *common neighborhood* of A and B . If the common neighborhood of A and B is nonempty, A and B are said to be *neighbors*.

Definition 1 (perfect fusion graph) Let (E, Γ) be a graph. We say that (E, Γ) is a perfect fusion graph (PFG) if, for any $S \subseteq E$, any two connected components A and B of S which are neighbors can be merged through $\Gamma(A, B)$.

In other words, the PFGs are the graphs in which two neighboring regions A and B can always be merged by removing from the separating set (\bar{S}) all the points which are adjacent to both regions. This class of graphs permits, in particular, to rigorously define hierarchical schemes (*i.e.* procedures which consist of successive region merging steps) and to implement them in a straightforward manner. Furthermore, we have shown [7] that the watershed transform [9, 10, 4, 11, 12], which is a popular segmentation method to obtain an initial segmentation for such a hierarchical scheme [13–16], satisfy stronger properties in PFGs than in general graphs.

The graph of Fig. 4a is not a PFG since the two gray components cannot be merged through $\{w\}$ which is their common neighborhood. On the other hand, the graph of Fig. 5 is a PFG. For instance, it can be verified in Fig. 5b that any two components of the white vertices which are neighbors can be merged through their common neighborhood.

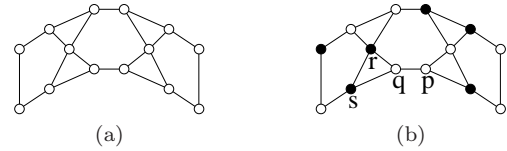

Fig. 5 An example of a perfect fusion graph with, in (b), a subset of the vertices (in white) on which the perfect fusion property can be tested.

The definition of the PFGs is based on a condition which must be verified for all subsets of the vertex sets. This means, if we want to check whether a graph is a PFG, then, using the straightforward method based on the definition, this will cost an exponential time with respect to the number of vertices. In fact, the PFGs can be recognized in a simpler way thanks to the following conditions which can be checked independently in the neighborhood of each vertex.

We denote by G^\blacktriangle the graph of Fig. 6.

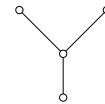

Fig. 6 The graph G^\blacktriangle used to characterize the perfect fusion graphs.

Theorem 2 (from Theorem 41 in [3]) The three following statements are equivalent:

- i) (E, Γ) is a PFG;
- ii) the graph G^\blacktriangle is not a subgraph of (E, Γ) ;
- iii) for any $x \in E$, any $X \subseteq \Gamma(x)$ contains at most two connected components.

Thanks to Theorem 2, it can be verified that the graph (E, Γ) depicted in Fig. 5 is a PFG. Indeed, G^\blacktriangle is not a subgraph of (E, Γ) . Remark in particular that the subgraph induced by $\{p, q, r, s\}$ is not G^\blacktriangle since it contains the edge (r, s) .

The next corollary follows straightforwardly from Theorem 2, and will be used in some subsequent proofs.

Corollary 3 If (E, Γ) is a PFG, then any subgraph of (E, Γ) is a PFG.

2 Cubical grids in arbitrary dimensions

Digital images are defined on (hyper-) rectangular subsets of \mathbb{Z}^d (with $d \in \mathbb{N}_*$). For region merging applications, \mathbb{Z}^d must be equipped with an adjacency relation reflecting the geometrical relationship between its elements. We provide, in this section, a set of definitions (which were first introduced in [17]) that allows for recovering the adjacency relations [5] which are the most frequently used in 2- and 3-dimensional image analysis and permit to extend them to images of arbitrary dimension (see [6] for an alternative definition of these adjacency relations on \mathbb{Z}^d).

Let \mathbb{Z} be the set of integers. We consider the families of sets H_0^1 and H_1^1 such that $H_0^1 = \{\{a\} \mid a \in \mathbb{Z}\}$ and $H_1^1 = \{\{a, a+1\} \mid a \in \mathbb{Z}\}$. Let $m \in [0, d]$. A subset C of \mathbb{Z}^d which is the Cartesian product of exactly m elements of H_1^1 and $(d-m)$ elements of H_0^1 is called a $(m-)$ cube of \mathbb{Z}^d .

Observe that an m -cube of \mathbb{Z}^d is a point if $m = 0$, a (unit) interval if $m = 1$, a (unit) square if $m = 2$ and a (unit) cube if $m = 3$.

Let \mathcal{C} be a set of cubes of \mathbb{Z}^d . The *binary relation induced by \mathcal{C}* is the set of all pairs (x, y) of \mathbb{Z}^d such that there exists a cube in \mathcal{C} which contains both x and y . Let (E, Γ) be a graph. We say that (E, Γ) is the *graph induced by \mathcal{C}* if $E = \cup\{C \mid C \in \mathcal{C}\}$ and Γ is the relation induced by \mathcal{C} . We call *cubical grid* any graph induced by a set of cubes.

Definition 4 (m -adjacency) Let $m \in [1, d]$. The m -adjacency on \mathbb{Z}^d , denoted by Γ_m^d , is the binary relation induced by the set of all m -cubes of \mathbb{Z}^d . If $(x, y) \in \Gamma_m^d$, we say that x and y are m -adjacent.

Observe that two points x and y of \mathbb{Z}^d (with $x = (x_1, \dots, x_d)$ and $y = (y_1, \dots, y_d)$) are m -adjacent if and only if $|x_i - y_i| \leq 1$ for any $i \in [1, d]$ and $\sum_{i=1}^d |x_i - y_i| \leq m$.

In the literature, Γ_1^2 and Γ_2^2 are often referred to as the *4-* and the *8-adjacencies* on \mathbb{Z}^2 , and Γ_1^3 , Γ_2^3 and Γ_3^3 are often referred to as the *6-*, the *18-* and the *26-adjacencies* on \mathbb{Z}^3 . The relations Γ_1^d and Γ_d^d are sometimes called respectively the *direct* and the *indirect adjacencies* on \mathbb{Z}^d .

Examples of graphs induced by Γ_1^2 and Γ_2^2 are shown in respectively Figs. 7a and b. The graphs induced by Γ_1^2 and Γ_2^2 are not, except in some degenerated cases, PFGs. For instance, it can be seen that any two white components which are neighbors in Fig. 7a cannot be merged. Thus, this graph which is induced by Γ_1^2 is not a PFG. In Fig. 7b, let us consider the set S of white and gray vertices. The two components of S , depicted in gray, are neighbors since

the points x and y are adjacent to both but they cannot be merged through $\{x, y\}$. Thus, this graph which is induced by Γ_2^2 is not a PFG. More generally, the graphs which are the most frequently used in image analysis (namely, those induced by Γ_1^d and Γ_d^d , with $d = 2, 3$) are not PFGs (see Sec. 6 in [3]).

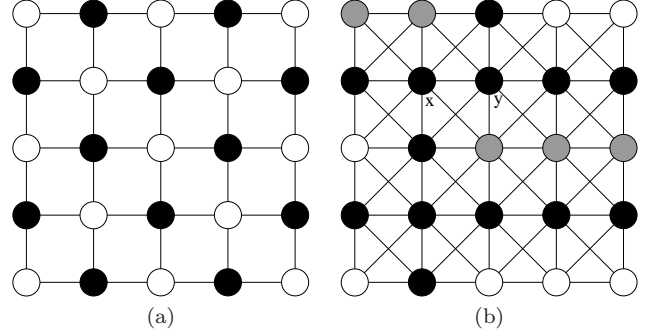

Fig. 7 (a): A graph induced by the 4-adjacency relation; no component of the set of white vertices can be merged. (b): A graph induced by the 8-adjacency relation; let S be the set of white and gray vertices; the two gray components A and B are neighbors and cannot be merged through their common neighborhood $\Gamma^*(A, B) = \{x, y\}$.

We now introduce a set of definitions and properties which allow us to handle the cubes of \mathbb{Z}^d and which will be used in the next section to define the perfect fusion grids.

In the following, we will denote by \mathcal{C}^d the set of all d -cubes of \mathbb{Z}^d . We define the *index map of \mathcal{C}^d* as the map φ from \mathcal{C}^d to \mathbb{Z}^d , such that for any $C \in \mathcal{C}^d$, $\varphi(C)_i = \min\{x_i \mid x \in C\}$, where $\varphi(C)_i$ is the i -th coordinate of $\varphi(C)$, for any $i \in [1, d]$. It may be seen that C is equal to the Cartesian product: $C = \{\varphi(C)_1, \varphi(C)_1 + 1\} \times \dots \times \{\varphi(C)_d, \varphi(C)_d + 1\}$. Thus, clearly φ is a bijection and allows for indexing the d -cubes of \mathbb{Z}^d .

Fig. 8 shows the values of the index map of \mathcal{C}^2 associated with a (rectangular) subset of \mathbb{Z}^2 .

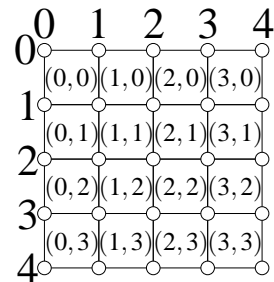

Fig. 8 Index map of \mathcal{C}^2 associated with a subset of \mathbb{Z}^2 .

We set $\mathbb{U}_* = \{1, -1\}$, $\mathbb{O} = \{0\}$ and $\mathbb{U} = \mathbb{O} \cup \mathbb{U}_*$. Let $u = (u_1, \dots, u_d) \in \mathbb{U}^d$. We denote by $-u$ the element of \mathbb{U}^d defined by $(-u)_i = -u_i$ for any $i \in [1, d]$. The number of non null coordinates of u is called the *dimension* of u .

Property 5 Let C and D be two d -cubes of \mathcal{C}^d .

1. The intersection between C and D is nonempty if and only if there exists $u \in \mathbb{U}$ such that $\varphi(C) = \varphi(D) + u$.
2. Furthermore, $C \cap D$ is an m -cube ($m \leq d$) if and only if there exists $u \in \mathbb{U}^d$ such that $(d - m)$ is the dimension of u and $\varphi(C) = \varphi(D) + u$.

Proof 1) The proof is trivial.

2) By 1), $C \cap D = \emptyset$ if and only if there is no $u \in \mathbb{U}^d$ such that $\varphi(C) = \varphi(D) + u$. Suppose now that $C \cap D \neq \emptyset$. By 1) there exists $u \in \mathbb{U}^d$ such that $\varphi(C) = \varphi(D) + u$. Let m be the dimension of u . Let us define, for any $i \in [1, d]$, the set K_i by:

$$\begin{aligned} K_i &= \{\varphi(D)_i, \varphi(D)_i + 1\} \text{ if } u_i = 0, \\ K_i &= \{\varphi(D)_i + 1\} \text{ if } u_i = 1, \text{ and} \\ K_i &= \{\varphi(D)_i\} \text{ if } u_i = -1. \end{aligned}$$

Let $K = K_1 \times \dots \times K_d$. By definition K is a $(d - m)$ -cube. Therefore, to complete the proof, it is sufficient to show that $x \in C \cap D$ if and only if $x \in K$. The sets C and D are the Cartesian products:

$$\begin{aligned} C &= \{\varphi(D)_1 + u_1, \varphi(D)_1 + u_1 + 1\} \times \dots \times \\ &\quad \{\varphi(D)_d + u_d, \varphi(D)_d + u_d + 1\}, \text{ and} \\ D &= \{\varphi(D)_1, \varphi(D)_1 + 1\} \times \dots \times \{\varphi(D)_d, \varphi(D)_d + 1\} \end{aligned}$$

Thus, $x \in C \cap D$ if and only if, for any $i \in [1, d]$, one of the following statements holds true:

1. $x_i = \varphi(D)_i + u_i = \varphi(D)_i$
2. $x_i = \varphi(D)_i + u_i = \varphi(D)_i + 1$
3. $x_i = \varphi(D)_i + u_i + 1 = \varphi(D)_i$
4. $x_i = \varphi(D)_i + u_i + 1 = \varphi(D)_i + 1$

Thus, $x \in C \cap D$ if and only if, for any $i \in [1, d]$,

- when $u_i = 0$, $x_i = \varphi(D)_i$ (case 1 above) or $x_i = \varphi(D)_i + 1$ (case 4 above),
- when $u_i = 1$, $x_i = \varphi(D)_i + 1$ (case 2 above), and
- when $u_i = -1$, $x_i = \varphi(D)_i$ (case 3 above).

Hence, by definition of K , $x \in C \cap D$ if and only if $x \in K$. \square

Let $x \in \mathbb{Z}^d$ and $u \in \mathbb{U}^d$, we denote by $C(u, x)$ the cube of \mathbb{Z}^d defined by $\{x_1, x_1 + u_1\} \times \dots \times \{x_d, x_d + u_d\}$. In other words, $C(u, x)$ is the set of all points y such that, for any $i \in [1, d]$, $y_i = x_i$ or $y_i = x_i + u_i$. We also set $\hat{C}(u, x) = C(-u, x)$

Fig. 9 illustrates this definition on \mathbb{Z}^2 and \mathbb{Z}^3 .

Remark 6 Let $x \in \mathbb{Z}^d$. Let u and v be two elements in \mathbb{U}^d ,

1. a subset C of \mathbb{Z}^d is a cube which contains x if and only if there exists $w \in \mathbb{U}^d$ such that $C = C(w, x)$;
2. $C(u, x) \cap \hat{C}(u, x) = \{x\}$;
3. $C(u, x) \subseteq C(v, x)$ if and only if, for any $i \in [1, d]$, $u_i = v_i$ or $u_i = 0$; and
4. $C(u, x)$ is an m -cube (with $m \in [1, d]$) of \mathbb{Z}^d if and only if m is the dimension of u .

In order to prove properties related to objects of arbitrary dimension, an important method consists of proceeding by induction on the dimension. The notion of section introduced hereafter is fundamental for proving by induction the main claims of this paper.

Let $x \in \mathbb{Z}^d$ and let u be an element of \mathbb{U}^d the dimension of which equals m . We denote by $P(u, x)$ the set $\{y \in \mathbb{Z}^d \mid \forall i \in [1, d], y_i = x_i + k_i \cdot u_i, \text{ where } k_i \in \mathbb{Z}\}$. We say that $P(u, x)$ is a (m) -section of \mathbb{Z}^d .

Remark 7 Let $x \in \mathbb{Z}^d$, $m \in [1, d]$ and let u, v be two elements of \mathbb{U}^d ,

1. $P(u, x) = P(v, x)$ if and only if, for any $i \in [1, d]$, $|u_i| = |v_i|$;
2. for any $y \in P(u, x)$, $C(u, y) \subseteq P(u, x)$ and $\hat{C}(u, y) \subseteq P(u, x)$; and
3. if m is the dimension of u and $n \in [1, d]$, then the subgraph of $(\mathbb{Z}^d, \Gamma_n^d)$ induced by $P(u, x)$ is isomorphic to $(\mathbb{Z}^m, \Gamma_k^m)$, where $k = \min\{m, n\}$.

3 Perfect fusion grids

As said in the previous section, the graphs associated with the adjacency relations which are the most frequently used in 2- and 3-dimensional image analysis are not, in general, PFGs. In [3], we introduced a family of graphs on \mathbb{Z}^d , called the *perfect fusion grids*, which are indeed PFGs and which are “between” Γ_1^d and Γ_d^d . In this section, we recall the definition of the perfect fusion grids and study some of their properties.

The perfect fusion grids can be defined, whatever the dimension $d \in \mathbb{N}_*$, by the mean of *chessboards*. Intuitively, a chessboard \mathcal{C} on \mathbb{Z}^d is a set of d -cubes which spans \mathbb{Z}^d (i.e. $\cup\{C \in \mathcal{C}\} = \mathbb{Z}^d$) and such that the intersection of any two cubes in \mathcal{C} is either empty or reduced to a point. We will show that there are two chessboards on \mathbb{Z}^2 . The gray squares shown in Figs. 2a and b constitute subsets of these two chessboards. The gray cubes shown in Fig. 10 constitute a subset of a chessboard on \mathbb{Z}^3 . The perfect fusion grids are the graphs induced by the chessboards on \mathbb{Z}^d (see, for instance, the graphs of Figs. 2a and b).

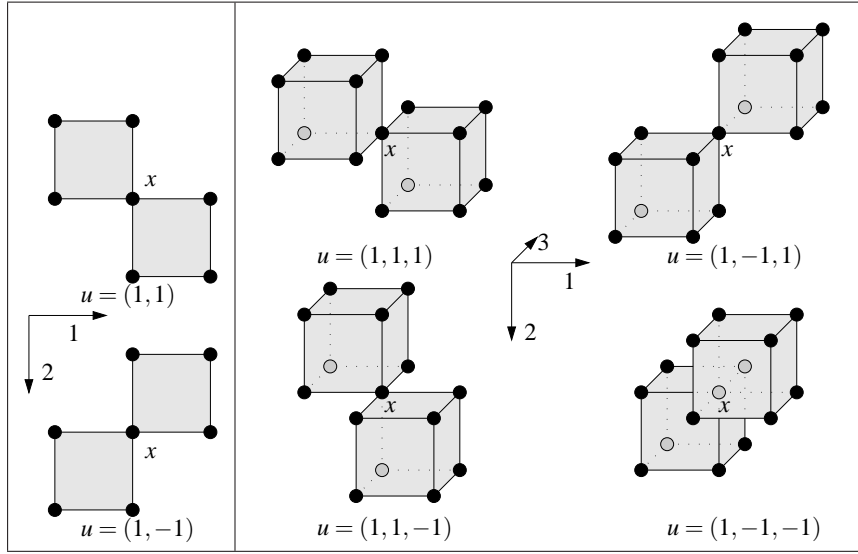

Fig. 9 First (resp. second) column: all possible local configurations in a local chessboard on \mathbb{Z}^2 (resp. \mathbb{Z}^3). In each column, we assume that \mathbb{Z}^d is oriented as shown by the arrows. Then, the element $u \in \mathbb{U}_*^d$ which “generates” each configuration $C(u, x) \cup \hat{C}(u, x)$ is written under the configuration.

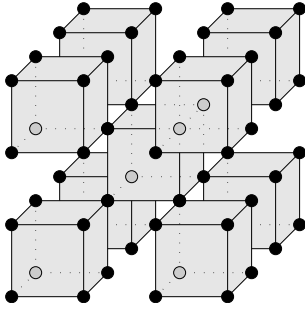

Fig. 10 The gray cubes constitute a subset of a chessboard on \mathbb{Z}^3 .

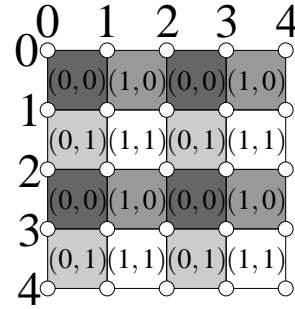

Fig. 11 The map ψ associated with a subset of \mathbb{Z}^2 .

Let us now give formal definitions of these notions.

Let $\mathbb{B} = \{0, 1\}$. Every element of \mathbb{B}^d is a *binary word of length d* . We set $\bar{0} = 1$ and $\bar{1} = 0$. If $b = (b_1, \dots, b_d)$ is in \mathbb{B}^d , we define \bar{b} as the binary word of \mathbb{B}^d such that for any $i \in [1, d]$, $(\bar{b})_i = (\bar{b}_i)$.

We remind that \mathcal{C}^d denotes the set of all d -cubes of \mathbb{Z}^d and that φ is the index map of \mathcal{C}^d . We define the map ψ from \mathcal{C}^d to \mathbb{B}^d such that for any $C \in \mathcal{C}^d$ and any $i \in [1, d]$, $\psi(C)_i$ is equal to $[\varphi(C)_i \bmod 2]$, that is the remainder in the integer division of $\varphi(C)_i$ by 2.

Fig. 11 shows the values of ψ associated with a (rectangular) subset of \mathbb{Z}^2 .

Definition 8 (chessboard & perfect fusion grid)

Let $b \in \mathbb{B}^d$.

We set $\mathcal{C}_b^d = \{C \in \mathcal{C}^d \mid \psi(C) = b\}$ and we say that the set $\mathcal{C}_b^d \cup \mathcal{C}_{\bar{b}}^d$ is a (global) chessboard on \mathbb{Z}^d .

Let \mathcal{C} be the chessboard on \mathbb{Z}^d defined by $\mathcal{C}_b^d \cup \mathcal{C}_{\bar{b}}^d$. We denote by Λ_b^d the adjacency relation induced by \mathcal{C} and

we say that the pair $(\mathbb{Z}^d, \Lambda_b^d)$ is a perfect fusion grid on \mathbb{Z}^d .

Figs. 11 and 2 illustrate these definitions on \mathbb{Z}^2 . In Figs. 11, the cubes which belong to $\mathcal{C}_{(0,0)}^2$, $\mathcal{C}_{(0,1)}^2$, $\mathcal{C}_{(1,0)}^2$ and $\mathcal{C}_{(1,1)}^2$ are represented with distinct gray levels. The gray cubes in Fig. 2a and b belong respectively to the chessboard $\mathcal{C}_{(0,0)}^2 \cup \mathcal{C}_{(1,1)}^2$ and to the chessboard $\mathcal{C}_{(1,0)}^2 \cup \mathcal{C}_{(0,1)}^2$. The depicted graphs are the two associated perfect fusion grids $\Lambda_{(1,1)}^2$ and $\Lambda_{(1,0)}^2$.

From their very definition, the number of distinct perfect fusion grids can be easily determined. The cardinality of \mathbb{B}^d is 2^d . Let b and b' in \mathbb{B}^d . Since $\mathcal{C}_b^d \cup \mathcal{C}_{\bar{b}}^d = \mathcal{C}_{\bar{b}}^d \cup \mathcal{C}_b^d$, and since $\mathcal{C}_b^d \cup \mathcal{C}_{\bar{b}}^d \neq \mathcal{C}_{b'}^d \cup \mathcal{C}_{\bar{b}'}^d$ whenever $\{b, \bar{b}\} \neq \{b', \bar{b}'\}$, there exist 2^{d-1} distinct chessboards on \mathbb{Z}^d . Thus, there are also 2^{d-1} distinct perfect fusion grids on \mathbb{Z}^d . However, any two (distinct) perfect fusion grids are equivalent up to a “binary translation”.

Property 9 (Property 58 in [3]) *Let b and b' be two elements of \mathbb{B}^d . There exists $t \in \mathbb{B}^d$ such that, for any x and y in \mathbb{Z}^d , we have $y \in \Lambda_b^d(x)$ if and only if $y + t \in \Lambda_{b'}^d(x + t)$.*

Certain classes of graphs (such as the PFGs, see Theorem 2.iii) can be locally characterized. It means that it can be tested if an arbitrary graph belongs to such a class by independently checking a condition in a limited neighborhood of each point. The following properties (Property 12 and Theorem 20) show that the chessboards and the perfect fusion grids can also be locally characterized.

Definition 10 (local chessboard) *Let \mathcal{C} be a set of d -cubes of \mathbb{Z}^d . We say that \mathcal{C} is a local chessboard on \mathbb{Z}^d if, for any $x \in \mathbb{Z}^d$, there exist two d -cubes C and \hat{C} of \mathbb{Z}^d such that:*

1. C and \hat{C} are the only two elements of \mathcal{C} which contain x ; and
2. $C \cap \hat{C} = \{x\}$.

For instance, it may be seen that, on \mathbb{Z}^2 (resp. \mathbb{Z}^3), a local chessboard \mathcal{C} is a set of 2-cubes (resp. 3-cubes) such that, for any point x , the cubes of \mathcal{C} which contain x match one of the two (resp. four) configurations depicted in the first (resp. second) column of Fig. 9. Observe that this notion of a local chessboard corresponds exactly to the intuitive idea given in the introduction of the section. As assessed by the following property, we can indeed prove that any global chessboard is necessarily a local chessboard.

Observe that two d -cubes C and \hat{C} of \mathbb{Z}^d are such that $C \cap \hat{C} = \{x\}$ for some $x \in \mathbb{Z}^d$ if and only if there exists $u \in \mathbb{U}_*^d$ such that $C = C(u, x)$ and $\hat{C} = \hat{C}(u, x)$. Thus, the local chessboards can be characterized as follows.

Remark 11 *Let \mathcal{C} be a set of d -cubes of \mathbb{Z}^d . The set \mathcal{C} is a local chessboard on \mathbb{Z}^d if and only if, for any $x \in \mathbb{Z}^d$, there exists $u \in \mathbb{U}_*^d$ such that $C(u, x)$ and $\hat{C}(u, x)$ belong to \mathcal{C} and such that they are the only two elements in \mathcal{C} which contain x .*

Property 12 *Let $b \in \mathbb{B}^d$. The chessboard $\mathcal{C} = \mathcal{C}_b^d \cup \mathcal{C}_{\bar{b}}^d$ is a local chessboard such that for any $x \in \mathbb{Z}^d$, the only two d -cubes of \mathcal{C} which contain x are $C(u, x)$ and $\hat{C}(u, x)$, where $u \in \mathbb{U}_*^d$ and $u_i = (-1)^{(x_i - b_i)}$ for any $i \in [1, d]$.*

Proof Let $x \in \mathbb{Z}^d$. As usual, let φ be the index map of \mathcal{C}^d . By the very definition of φ , it may be seen that any d -cube C of \mathbb{Z}^d which contains x is such that, for any $i \in [1, d]$, $\varphi(C)_i = x_i - 1$ or $\varphi(C)_i = x_i$.

Thus, by definition of ψ , there exists a unique d -cube C' which contains x and which belongs to \mathcal{C}_b^d . Let $u \in \mathbb{U}_*^d$ be defined by $u_i = (-1)^{(x_i - b_i)}$ for any $i \in [1, d]$. We set $C' = C(u, x)$ and we will prove that $C' = C$. By definition, C' is equal to the Cartesian product $C' = \{x_1, x_1 + (-1)^{(x_1 - b_1)}\} \times \cdots \times \{x_d, x_d + (-1)^{(x_d - b_d)}\}$. Let $i \in [1, d]$. Let us first suppose that $(x_i - b_i)$ is even. Then, $(-1)^{(x_i - b_i)} = 1$. Thus, by definition of φ , $\varphi(C')_i = x_i$. In this case, either x_i and b_i are both even or x_i and b_i are both odd. Thus, $\psi(C')_i = b_i$. Suppose now that $(x_i - b_i)$ is odd. Then, $\varphi(C')_i = x_i - 1$. In this case, $(x_i \bmod 2) = \bar{b}_i$. Hence, $\psi(C') = (\varphi(C')_i \bmod 2) = b_i$. Thus, for any $i \in [1, d]$, we have $\psi(C')_i = b_i$. Hence, $C' \in \mathcal{C}_b^d$. Furthermore, by definition of C' , $x \in C'$. Thus, by definition of C , $C = C'$. Using similar arguments, we can prove that $\hat{C}(u, x)$ is the only d -cube of $\mathcal{C}_{\bar{b}}^d$ which contains x . This completes the proof of Property 12. \square

The previous property allows us to study $\Lambda_b^d(x)$, for any $b \in \mathbb{B}^d$ and $x \in \mathbb{Z}^d$. In particular, it is clear that, for any $x \in \mathbb{Z}^d$, any subset of $\Lambda_b^d(x)$ contains at most two connected components. Hence, by Theorem 2.iii, we deduce the following property.

Corollary 13 *Let $b \in \mathbb{B}^d$. Then the graph $(\mathbb{Z}^d, \Lambda_b^d)$ is a PFG.*

Another consequence of Property 12 is that any perfect fusion grid on \mathbb{Z}^d is between the graphs induced by the 1-adjacency and the d -adjacency.

Corollary 14 *Let $b \in \mathbb{B}^d$. Then, we have $\Gamma_1^d \subseteq \Lambda_b^d \subseteq \Gamma_d^d$.*

Proof 1) Let us prove the first inclusion relation. It follows from Property 12 that, for any $x \in \mathbb{Z}^d$, there exists $u \in \mathbb{U}_*^d$ such that $C(u, x) \cup \hat{C}(u, x) \subseteq \Lambda_b^d(x)$. If y is a point which is 1-adjacent to x , then, by definition of Γ_1^d , there exists a unique $j \in [1, d]$ such that $|y_j - x_j| = 1$ and, for any $i \in [1, d] \setminus \{j\}$, $y_i = x_i$. If $y_j - x_j = u_j$, then y belongs to $C(u, x)$ and if $y_j - x_j = -u_j$, then y belongs to $\hat{C}(u, x)$. In these two cases, y belongs to $\Lambda_b^d(x)$, which proves the first inclusion.

2) By definition, the relation Λ_b^d is induced by a chessboard and Γ_d^d is induced by \mathcal{C}^d . Thus, to establish the second inclusion, it suffices to note that any chessboard on \mathbb{Z}^d is a subset of \mathcal{C}^d . \square

Property 12 also explicits a practical way to manipulate the perfect fusion grids. Let $b \in \mathbb{B}^d$ and suppose for instance that we are interested in constructing the graph $(\mathbb{Z}^d, \Lambda_b^d)$. To reach this goal, starting from an

empty relation Γ , a straightforward algorithm, according to Property 12, consists of repeating the following three steps for each point $x \in \mathbb{Z}^d$:

- $u := ((-1)^{(x_1-b_1)}, \dots, (-1)^{(x_d-b_d)})$;
- $C := C(u, x)$ and $\hat{C} := \hat{C}(u, x)$;
- for each $y \in C \cup \hat{C}$ do $\Gamma := \Gamma \cup (x, y)$.

Let us now prove an essential result (Theorem 20) that will be used in the sequel and which states that any local chessboard is a global chessboard. To this end, we start by four lemmas (Lemmas 15, 17, 18 and 19).

Lemma 15 *Let \mathcal{C} be a local chessboard. Let C and C' be distinct d -cubes of \mathbb{Z}^d such that $C \cap C' \neq \emptyset$ and suppose that $C \in \mathcal{C}$. Then, $C' \in \mathcal{C}$ if and only if there exists $u \in \mathbb{U}_*^d$ such that $\varphi(C') = \varphi(C) + u$.*

Proof Let us first suppose that $C' \in \mathcal{C}$. Let $x \in C \cap C'$. By the very definition of a local chessboard $C \cap C' = \{x\}$. Thus, since $\{x\}$ is a 0-cube, by Property 5, there exists an element in \mathbb{U}_*^d (i.e., an element in \mathbb{U}^d whose dimension is d) such that $\varphi(C') = \varphi(C) + u$. This proves the forward implication.

Let us now suppose that there exists $u \in \mathbb{U}_*^d$ such that $\varphi(C') = \varphi(C) + u$. Then,

$$C = \{\varphi(C)_1, \varphi(C)_1 + 1\} \times \dots \times \{\varphi(C)_d, \varphi(C)_d + 1\}; \text{ and} \quad (1)$$

$$C' = \{\varphi(C)_1 + u_1, \varphi(C)_1 + u_1 + 1\} \times \dots \times \{\varphi(C)_d + u_d, \varphi(C)_d + u_d + 1\}. \quad (2)$$

Let us consider the point $x \in \mathbb{Z}^d$ defined by $x_i = \varphi(C)_i + 1$ if $u_i = 1$ and $x_i = \varphi(C)_i$ if $u_i = -1$, for any $i \in [1, d]$. If $u_i = 1$, then $\{\varphi(C)_i, \varphi(C)_i + 1\} = \{x_i - 1, x_i\} = \{x_i - u_i, x_i\}$ and $\{\varphi(C)_i + u_i, \varphi(C)_i + u_i + 1\} = \{x_i - 1 + u_i, x_i + u_i\} = \{x_i, x_i + u_i\}$. If $u_i = -1$, then $\{\varphi(C)_i, \varphi(C)_i + 1\} = \{x_i, x_i + 1\} = \{x_i, x_i - u_i\}$ and $\{\varphi(C)_i + u_i, \varphi(C)_i + u_i + 1\} = \{x_i + u_i, x_i + u_i + 1\} = \{x_i + u_i, x_i\}$. Hence, equations 1 and 2 can be rewritten as:

$$C = \{x_1, x_1 - u_1\} \times \dots \times \{x_d, x_d - u_d\} \quad (3)$$

$$C' = \{x_1, x_1 + u_1\} \times \dots \times \{x_d, x_d + u_d\}. \quad (4)$$

Thus, $C = \hat{C}(u, x)$ and $C' = C(u, x)$. Therefore, since $C \in \mathcal{C}$ and since both C and C' contain x , by Remark 11, we deduce that $C' \in \mathcal{C}$. \square

For instance, in Fig. 10, if the central gray cube belongs to a local chessboard on \mathbb{Z}^3 then and only then the other depicted gray cubes also belong to this local chessboard.

Remark 16 *Let \mathcal{C} be a local chessboard. Let $\langle u^1, \dots, u^\ell \rangle$ be a sequence of elements in \mathbb{U}_*^d and C be a d -cube of \mathbb{Z}^d . If C belongs to \mathcal{C} , by induction on Lemma 15, it may be deduced that the d -cube C' of \mathbb{Z}^d , defined by $\varphi(C') = \varphi(C) + \sum_{k=1}^\ell u^k$, also belongs to \mathcal{C} .*

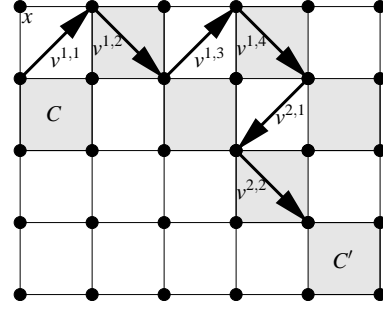

Fig. 12 Illustration of the method used to prove Lemma 17. We suppose that \mathbb{Z}^2 is oriented as shown in Fig. 9 and that $x = (0, 0)$ and we consider C and C' as the 2-cubes of $\mathcal{C}_{(0,1)}^2$ defined by $\varphi(C) = (0, 1)$ and $\varphi(C') = (4, 3)$.

For instance, in Fig. 12, if the 2-cube C belongs to a local chessboard \mathcal{C} on \mathbb{Z}^2 , then the 2-cube C' also belong to \mathcal{C} since $\varphi(C') = \varphi(C) + v^{1,1} + v^{1,2} + v^{1,3} + v^{1,4} + v^{2,1} + v^{2,2}$.

Lemma 17 *Let \mathcal{C} be a local chessboard on \mathbb{Z}^d . Let $b \in \mathbb{B}^d$ and $C \in \mathcal{C}_b^d$. If C belongs to \mathcal{C} , then any $C' \in \mathcal{C}_b^d$ belongs to \mathcal{C} .*

Proof Let $C' \in \mathcal{C}_b^d$. We are going to show that there exists a sequence $s = \langle u^1, \dots, u^\ell \rangle$ of elements in \mathbb{U}_*^d such that $\varphi(C') = \varphi(C) + \sum_{k=1}^\ell u^k$. Hence, by Remark 16, this will complete the proof of Lemma 17. In order to build such a sequence, we will proceed dimension by dimension. Let $i \in [1, d]$. We set $R_i = [\varphi(C')_i - \varphi(C)_i]$. We observe that R_i is even since $\psi(C) = \psi(C') = b$. We consider $s^i = \langle v^{i,1}, \dots, v^{i,|R_i|} \rangle$, the sequence of $|R_i|$ elements in \mathbb{U}_*^d defined, for any $j \in [1, |R_i|]$, by:

$$(v^{i,j})_i = 1 \text{ if } R_i \geq 0 \text{ and } (v^{i,j})_i = -1 \text{ if } R_i < 0 \text{ and} \\ (v^{i,j})_k = (-1)^j \text{ for any } k \in [1, d] \setminus \{i\}.$$

Fig. 12 shows the sequences s^1 and s^2 when C and C' are the 2-cubes of $\mathcal{C}_{(0,1)}^2$ defined by $\varphi(C) = (0, 1)$ and $\varphi(C') = (4, 3)$.

Let $\sigma^i = \sum_{j=1}^{|R_i|} v^{i,j}$. We have:

$$(\sigma^i)_i = R_i; \text{ and}$$

$$(\sigma^i)_k = 0 \text{ for any } k \in [1, d] \setminus \{i\} \text{ (since, as seen above, } \\ R_i \text{ is even)}.$$

Thus, $\varphi(C') = \varphi(C) + \sum_{i=1}^d \sigma^i$. Let $s = \langle u^1, \dots, u^\ell \rangle$ be the sequence defined by concatenation of s^1, s^2, \dots , and s^d , i.e., $s = \langle v^{1,1}, \dots, v^{1,|R_1|}, v^{2,1}, \dots, v^{2,|R_2|}, \dots, v^{d,|R_d|} \rangle$. It can be seen that $\sum_{k=1}^\ell u^k = \sum_{i=1}^d \sigma^i$. Hence, $\varphi(C') = \varphi(C) + \sum_{k=1}^\ell u^k$. Therefore, according to Remark 16, C' belongs to \mathcal{C} . \square

Lemma 18 *Let \mathcal{C} be a local chessboard on \mathbb{Z}^d and let $b \in \mathbb{B}^d$. Let $C \in \mathcal{C}_b^d$. If C belongs to \mathcal{C} , then any $C' \in \mathcal{C}_b^d$ belongs to \mathcal{C} .*

Proof Let $u \in \mathbb{U}_*^d$. From Lemma 15, the cube D such that $\varphi(D) = \varphi(C) + u$ also belongs to \mathcal{C} . It may be seen that, for any i in $[1, d]$, $\psi(D)_i = \overline{\psi(C)_i}$. Hence, since $C \in \mathcal{C}_b^d$, $D \in \mathcal{C}_b^d$. Thus, by Lemma 17, any $C' \in \mathcal{C}_b^d$ belongs to \mathcal{C} . \square

Lemma 19 *Let \mathcal{C} be a local chessboard on \mathbb{Z}^d , let $b \in \mathbb{B}^d$ and let $C \in \mathcal{C}_b^d$. If C belongs to \mathcal{C} , then any $C' \in \mathcal{C}^d \setminus [\mathcal{C}_b^d \cup \overline{\mathcal{C}_b^d}]$ does not belong to \mathcal{C} .*

Proof Let $C' \in \mathcal{C}^d \setminus [\mathcal{C}_b^d \cup \overline{\mathcal{C}_b^d}]$. We set $c \in \mathbb{B}^d$ such that, for any $i \in [1, d]$, $c_i = 0$ if $\psi(C')_i = b_i$ and $c_i = 1$ otherwise. Let $D \in \mathcal{C}^d$ be defined by $\varphi(D) = \varphi(C') + c$. For any $i \in [1, d]$, $\psi(D)_i = [(\varphi(C')_i + c_i) \bmod 2] = [(\psi(C')_i + c_i) \bmod 2]$ which, by definition of c_i , equals b_i . Thus, $D \in \mathcal{C}_b^d$. Therefore, according to Lemma 17, D belongs to \mathcal{C} . By Property 5, we have $D \cap C' \neq \emptyset$. Furthermore, there exist distinct i and j in $[1, d]$ such that $c_i = 0$ and $c_j = 1$ (otherwise, C' would belong to $\mathcal{C}_b^d \cup \overline{\mathcal{C}_b^d}$). Thus, $c \notin \mathbb{U}_*^d$. Hence, by Lemma 15, C' does not belong to \mathcal{C} . \square

From Property 12, Lemmas 17, 18 and 19, we can establish the equivalence between global and local chessboards.

Theorem 20 *Let \mathcal{C} be a set of d -cubes of \mathbb{Z}^d . The set \mathcal{C} is a chessboard on \mathbb{Z}^d if and only if \mathcal{C} is a local chessboard on \mathbb{Z}^d .*

Thus, to check whether a graph (\mathbb{Z}^d, Γ) is a perfect fusion grid it suffices to verify that it is induced by a local chessboard. This can be done by independently analyzing the neighborhood of each of its vertices.

4 Unicity theorem

We prove in this section one of the main result of our paper. It states that the only PFGs which are “between” Γ_1^d and Γ_d^d are the perfect fusion grids. Since any two perfect fusion grids are equivalent up to a binary translation (Property 9), this result establishes the uniqueness of the perfect fusion grid in any dimension $d \in \mathbb{N}_*$.

Theorem 21 *Let (\mathbb{Z}^d, Γ^d) be a graph such that $\Gamma_1^d \subseteq \Gamma^d \subseteq \Gamma_d^d$. The pair (\mathbb{Z}^d, Γ^d) is a PFG, if and only if it is a perfect fusion grid on \mathbb{Z}^d .*

In other words, the perfect fusion grid is, in any dimension, the only graph, “between” the direct and indirect adjacencies, which verify the property that any two neighboring regions can be merged through their common neighborhood while preserving all other regions.

We have seen that the perfect fusion grids are PFGs between Γ_1^d and Γ_d^d . Thus, thanks to Theorem 20, in order to establish Theorem 21, it suffices to prove that any PFG between Γ_1^d and Γ_d^d is induced by a local chessboard.

Important remark. In the following, we assume that the graph (\mathbb{Z}^d, Γ^d) is a PFG such that $\Gamma_1^d \subseteq \Gamma^d \subseteq \Gamma_d^d$. Furthermore, when no confusion may occur, the graph (\mathbb{Z}^d, Γ^d) is simply written Γ^d .

In the case $d = 1$, $\Gamma^d = \Gamma_1^1$ (since $\Gamma_1^1 \subseteq \Gamma^d \subseteq \Gamma_1^1$) which obviously is a PFG.

In order to give an intuition of the proof of Theorem 21 in arbitrary dimension, let us first establish it (in a combinatorial manner) in the case $d = 2$. To this end, as said above, we have to show that Γ^2 is induced by a local chessboard on \mathbb{Z}^2 . Thus, we must show that, for any $x \in \mathbb{Z}^d$, there exists $u \in \mathbb{U}_*^2$ such that the graph induced by $\Gamma^2(x)$ is equal to the graph induced by $C(u, x) \cup \hat{C}(u, x)$. Since $\Gamma_1^2 \subseteq \Gamma^2$, we know that the edges depicted in bold Fig. 13a belong to Γ^2 . In this figure, the subgraph induced by $\{x_8, x, x_2, x_4\}$ is isomorphic to G^\blacktriangle , thus, since Γ^2 is a PFG, by Theorem 2.ii, either $(x_2, x_4) \in \Gamma^2$ or $(x_2, x_8) \in \Gamma^2$. We will consider here the case $(x_2, x_4) \in \Gamma^2$ (such as depicted in Fig. 13b). However, the arguments given below also hold true (up to a rotation of $\pi/2$) in the case where $(x_2, x_8) \in \Gamma^2$. If $(x_4, x_6) \in \Gamma^2$, then the subgraph induced by $\{x_4, x_6, x_2, w\}$ is isomorphic to G^\blacktriangle (where w is the point shown in Fig. 13b). Thus, according to Theorem 2.ii, $(x_4, x_6) \notin \Gamma^2$ since Γ^2 is a PFG (Fig. 13c). Using similar arguments (with the point w' shown in Fig. 13c), it can be deduced that $(x_6, x_8) \in \Gamma^2$ and that $(x_8, x_2) \notin \Gamma^2$ (Fig. 13d). If $(x, x_5) \in \Gamma^2$, then the subgraph of Γ^2 induced by $\{x, x_2, x_5, x_8\}$ would be isomorphic to G^\blacktriangle . Thus, again by Theorem 2.ii, $(x, x_5) \notin \Gamma^2$. Using symmetric arguments, we obtain $(x, x_1) \notin \Gamma^2$ (Fig. 13f). By considering the points x_4, x, x_3, x_5 , it may be seen that necessarily $(x, x_3) \in \Gamma^2$ (otherwise the subgraph of Γ^2 induced by $\{x_4, x, x_3, x_5\}$ is isomorphic to G^\blacktriangle). Using symmetric arguments we obtain $(x, x_7) \in \Gamma^2$ (Fig. 13e). Hence, it can be seen that there exists $u \in \mathbb{U}_*^2$ such that the neighborhood of x for Γ^2 is induced by $C(u, x) \cup \hat{C}(u, x)$. Thus, Γ^2 is a perfect fusion graph only if it is induced by a local chessboard on \mathbb{Z}^2 .

Property 22 *For any $x \in \mathbb{Z}^d$, there exists $u \in \mathbb{U}_*^d$ such that $C(u, x)$ and $\hat{C}(u, x)$ are the only two maximal cliques for Γ^d which contain x .*

The following corollary follows straightforwardly from Property 22 and, by the observations stated below Theorem 21, it completes the proof of Theorem 21.

of a point x in this section can take $\#(d-1) = 2^{d-2}$ configurations (since there are 2^{d-1} elements in \mathbb{U}_*^{d-1} and since $C(u, x) \cup \hat{C}(u, x) = C(-u, x) \cup \hat{C}(-u, x)$). Let us now suppose that we know the neighborhood of x in one given $(d-1)$ -section $P(u^i, x)$ of \mathbb{Z}^d and let us denote by $\#'(d-1)$ the number of possible configurations that can be taken by the neighborhood of x in a distinct section $P(u^j, x)$ of \mathbb{Z}^d . The squares in light gray Figs. 14a and b indicate the only two possible configurations of the neighborhood of x in $P((1, 0, 1), x)$ whenever the neighborhood of x in $P((0, 1, 1), x)$ is the one indicated by the cubes in dark gray. Thus, $\#'(2) = \#(2) = 2$. In other words, on \mathbb{Z}^3 , having fixed the neighborhood of x in one section does not decrease the number of possible neighborhoods of x in other sections. Surprisingly, in higher dimensions, this number $\#'(d-1)$ of possible configurations remain unchanged: $\forall d \geq 3$ we have $\#'(d-1) = 2$. The following lemma allows us to establish this number. Furthermore, Lemma 27 gives all the possible neighborhood of x in $P(u^2, x)$, knowing the neighborhood of x in $P(u^1, x)$. Note that Lemma 27 can be easily generalized to any pair of $(d-1)$ -sections, *i.e.* when i and j can take any two distinct values in $[1, d]$.

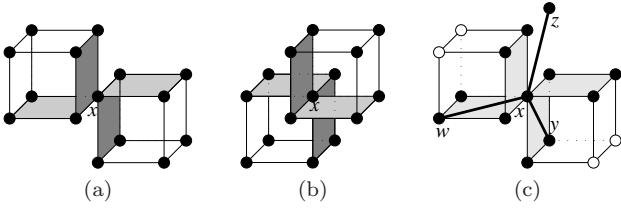

Fig. 14 In each sub-figure, we assume that \mathbb{Z}^3 is oriented as shown in Fig. 9. (a,b) Illustration of Lemma 27: the two possible configurations of the neighborhood of x in $P((1, 0, 1), x)$ (light gray) having fixed the neighborhood of x in $P((0, 1, 1), x)$ (dark gray). (c), Illustration of a 3D configuration used in the proof of Lemma 25.1. We assume that $x = (0, 0, 0)$. We suppose also that $v = (0, 1, 1)$, that $v' = (1, 0, 1)$ and that $z = (0, -1, 1)$. The 2-cubes represented in gray correspond to $C(v, x)$, $\hat{C}(v, x)$, $C(v', x)$ and $\hat{C}(v', x)$.

Lemma 27 Let $x \in \mathbb{Z}^d$. Let v (resp. v') be the element of $[\mathbb{O} \times \mathbb{U}_*^{d-1}]$ (resp. $[\mathbb{U}_* \times \mathbb{O} \times \mathbb{U}_*^{d-2}]$) such that $C(v, x)$ and $\hat{C}(v, x)$ (resp. $C(v', x)$ and $\hat{C}(v', x)$) are the only two maximal cliques, which contains x , for the subgraph of Γ^d induced by $P(u^1, x)$ (resp. $(P(u^2, x), \Gamma^d)$).

Then, we have either $v_k = v'_k$ for any $k \in [3, d]$ or $v_k = -v'_k$ for any $k \in [3, d]$.

Proof (by contradiction) Let us suppose that there exist distinct i and j in $[3, d]$ such that $v_i = v'_i$ and $v_j = -v'_j$. Remark that $v'_i \neq 0$ and $v'_j \neq 0$. Let y, z and w be three elements of \mathbb{Z}^d defined for any $k \in [1, d]$ by $y_k = x_k + v_k$, $z_k = x_k + v'_k$ and $w_k = x_k - v'_k$. Thus,

$y \in C(v, x)$, $z \in C(v', x)$ and $w \in \hat{C}(v', x)$. Thus, by the hypothesis of Lemma 27, we have: $\underline{y \in \Gamma^d(x)}$, $\underline{z \in \Gamma^d(x)}$ and $\underline{w \in \Gamma^d(x)}$. Since $y_j = x_j + v_j = x_j - v'_j$, $z_j = x_j + v'_j$ and $v'_j \neq 0$, we deduce that $(y, z) \notin \Gamma^d$. Furthermore, since $y_i = z_i = x_i + v'_i$, $w_i = x_i - v'_i$ and $v'_i \neq 0$, we deduce that (w, y) and (w, z) do not belong to Γ^d . Therefore, $\Gamma^d \subseteq \Gamma^d$ implies $\underline{(y, z) \notin \Gamma^d}$, $\underline{(w, y) \notin \Gamma^d}$ and $\underline{(w, z) \notin \Gamma^d}$. From the underlined observations, we deduce that $\{y, z, w\} \subseteq \Gamma^d(x)$ is made of three connected components and thus, by Theorem 2.iii, that (\mathbb{Z}^d, Γ^d) is not a PFG, a contradiction. \square

Proof (of Lemma 25.1, by contradiction) By Lemma 26, there exists v (resp. v') in $[\mathbb{O} \times \mathbb{U}_*^{d-1}]$ (resp. $[\mathbb{U}_* \times \mathbb{O} \times \mathbb{U}_*^{d-2}]$) such that $C(v, x)$ and $\hat{C}(v, x)$ (resp. $C(v', x)$ and $\hat{C}(v', x)$) are the only two maximal cliques, which contain x , for the subgraph of Γ^d induced by $P(u^1, x)$ (resp. $P(u^2, x)$). Fig. 14c provides an illustration of this proof. By Lemma 27, we have either $v_i = v'_i$ for any $i \in [3, d]$ or $v_i = -v'_i$ for any $i \in [3, d]$. Without loss of generality, we will assume that the former assertion is the one which holds true. Let $u \in \mathbb{U}_*^d$ be defined by (v'_1, v_2, \dots, v_d) . Suppose that there exists $z \in \Gamma^d(x) \setminus [C(u, x) \cup \hat{C}(u, x)]$. Then, there exist two distinct i and j in $[1, d]$ such that $z_i = x_i + u_i$ and $z_j = x_j - u_j$ (otherwise z would belong either to $C(u, x)$ or to $\hat{C}(u, x)$). Let us distinguish the two following cases.

1) Suppose that $i \neq 2$ and that $j \neq 1$ (as this is the case in Fig. 14c where $i = 3$ and $j = 2$). Then, we define y and w in \mathbb{Z}^d by $y = (x_1, x_2 + u_2, \dots, x_d + u_d)$ and $w = (x_1 - u_1, x_2, x_3 - u_3, \dots, x_d - u_d)$. Hence, $y \in C(v, x)$ and $w \in \hat{C}(v', x)$. Since $j \neq 1$ and $i \neq 2$, $y_j = x_j + u_j$ and $w_i = x_i - u_i$. Since $z_j = x_j - u_j$ and $z_i = x_i + u_i$, we deduce that $(z, y) \notin \Gamma^d$ and that $(z, w) \notin \Gamma^d$.

2) Suppose that $i = 2$ or that $j = 1$. Then, we define y and w in \mathbb{Z}^d by $y = (x_1, x_2 - u_2, \dots, x_d - u_d)$ and $w = (x_1 + u_1, x_2, x_3 + u_3, \dots, x_d + u_d)$. Hence, $y \in \hat{C}(v, x)$ and $w \in C(v', x)$. Since i and j are distinct, it can be seen that $i \neq 1$ and $j \neq 2$. Thus, $y_i = x_i - u_i$ and $w_j = x_j + u_j$. Since $z_i = x_i + u_i$ and $z_j = x_j - u_j$, we deduce that $(y, z) \notin \Gamma^d$ and that $(w, z) \notin \Gamma^d$.

As $\Gamma^d \subseteq \Gamma^d$, in any case we have: $\underline{(y, z) \notin \Gamma^d}$ and $\underline{(w, z) \notin \Gamma^d}$. Since $y \in C(v, x) \cup \hat{C}(v, x)$ and $w \in C(v', x) \cup \hat{C}(v', x)$, by definition of v and v' , we have: $\underline{y \in \Gamma^d(x)}$ and $\underline{w \in \Gamma^d(x)}$. In case 1), $y_3 = x_3 + u_3$ whereas $w_3 = x_3 - u_3$ and, in case 2), $y_3 = x_3 - u_3$ whereas $w_3 = x_3 + u_3$. Thus, in both cases, $(w, y) \notin \Gamma^d$. Hence, $\Gamma^d \subseteq \Gamma^d$ implies $\underline{(w, y) \notin \Gamma^d}$. From the underlined relations, we deduce that $\{w, y, z\} \subseteq \Gamma^d(x)$ is made of three connected components. By Theorem 2.iii, this constitutes a contradiction with the fact that (\mathbb{Z}^d, Γ^d) is a PFG. \square

To establish Lemma 25.2, we first consider the points which are $(d-1)$ -adjacent to x .

Lemma 28 *Assume that the Induction Hypothesis 24 holds true.*

Let $x \in \mathbb{Z}^d$. Let C and \hat{C} be two d -cubes of \mathbb{Z}^d which verify the condition (1) of Lemma 25.

Then, any $(d-1)$ -cube included in C or in \hat{C} and which contains x is a clique for Γ^d .

Proof (by contradiction) In this proof and the following ones, we only consider the d -cube C . Exactly the same arguments hold for \hat{C} . By Lemma 25.1, there exists $u \in \mathbb{U}_*^d$ such that $C = C(u, x)$, $\hat{C} = \hat{C}(u, x)$ and $\Gamma^d(x) \subseteq C \cup \hat{C}$. Suppose that there exists a $(d-1)$ -cube of \mathbb{Z}^d denoted by C^{d-1} which is included in C , which contains x and which is not a clique for Γ^d . By Remark 6.1, there exists $v \in \mathbb{U}^d$ such that $C^{d-1} = C(v, x)$. By Remark 6.4, the dimension of v is $(d-1)$. Let i be the unique index in $[1, d]$ such that $v_i = 0$. By Lemma 26, there exists $w \in \mathbb{U}_*^{i-1} \times \mathbb{O} \times \mathbb{U}_*^{d-i}$ such that $C(w, x)$ and $\hat{C}(w, x)$ are the only two maximal cliques which contain x for the subgraph of Γ^d induced by $P(v, x)$. By Remark 7.2, C^{d-1} is a subset of $P(v, x)$. Since C^{d-1} is not a clique for (\mathbb{Z}^d, Γ^d) , we deduce that $v \neq w$ and $v \neq -w$. Thus, there exist distinct indices j and k in $[1, d] \setminus \{i\}$ such that $v_j = w_j$ and $v_k = -w_k$. Let $y \in \mathbb{Z}^d$ be defined by $y_j = x_j + w_j$, $y_k = x_k + w_k$ and $y_\ell = x_\ell$ for any index $\ell \in [1, d] \setminus \{j, k\}$. The point y belongs to $C(w, x)$. Thus, $(x, y) \in \Gamma^d$. But, since $C^{d-1} \subseteq C(u, x)$, from Remark 6.3, we know that $u_j = v_j$ and $u_k = v_k$ (as $j, k \in [1, d] \setminus \{i\}$ and as v_i is the only null coordinate of v). Therefore, $u_j = w_j$ and $u_k = -w_k$. As $y_j = x_j + w_j = x_j + u_j$ and $y_k = x_k + w_k = x_k - u_k$, $y \notin C(u, x)$ and $y \notin \hat{C}(u, x)$ which, by Lemma 25.1, is a contradiction with the fact that Γ^d is a PFG. \square

Proof (of Lemma 25.2) If x and y belong to a same $(d-1)$ -cube the proof is established by Lemma 28. Suppose now that they do not. By Lemma 25.1, there exists $u \in \mathbb{U}_*^d$ such that $C = C(u, x)$, $\hat{C} = \hat{C}(u, x)$ and $\Gamma^d(x) \subseteq C \cup \hat{C}$. Without loss of generality, we suppose that $y \in C$. Then, $y = (x_1 + u_1, \dots, x_d + u_d)$ (see, Fig. 15a). Let $z = (x_1 + u_1, \dots, x_{d-1} + u_{d-1}, x_d)$ and $w = (x_1 + u_1, \dots, x_{d-1} + u_{d-1}, x_d - u_d)$. It may be seen that $(y, z) \in \Gamma_1^d$ and $(w, z) \in \Gamma_1^d$. Since $\Gamma_1^d \subseteq \Gamma^d$, we have: $(y, z) \in \Gamma^d$ and $(w, z) \in \Gamma^d$. We can also observe that x and z are $(d-1)$ -adjacent and that $z \in C$. Therefore, by Lemma 28, we deduce $(x, z) \in \Gamma^d$.

Clearly $w \notin C$ and $w \notin \hat{C}$. Thus, by the converse of Lemma 25.1, $(x, w) \notin \Gamma^d$. Since $w_d = x_d - u_d$ and $y_d = x_d + u_d$, there is no d -cube that contains both w and y : $(w, y) \notin \Gamma^d$. Thus, since $\Gamma^d \subseteq \Gamma_d^d$, $(w, y) \notin \Gamma^d$. From

the underlined relations, we deduce that $\{w, x, y\} \subseteq \Gamma^d(z)$. Furthermore, since Γ^d is a PFG, $\{w, x, y\}$ contains at most two connected components. Thus, from the underlined relations, we must have $(x, y) \in \Gamma^d$. \square

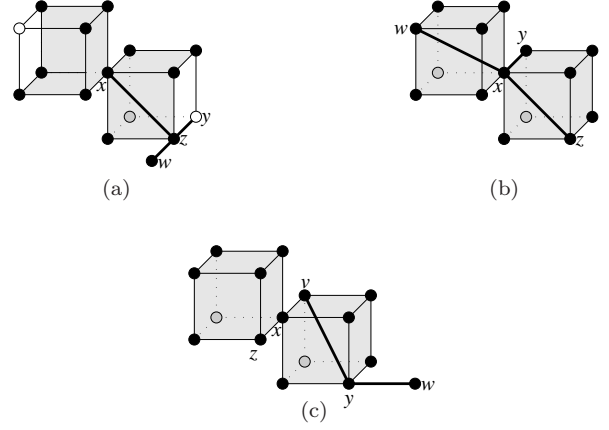

Fig. 15 (a,b,c) Illustrations of the configurations of the points used in the proofs of Lemmas 25.2, 25.3 and 25.4. We assume that \mathbb{Z}^3 is oriented as shown in Fig. 9, that $x = (0, 0, 0)$ and that $u = (1, 1, 1)$. In (b), we furthermore assume $y = (0, 0, 1)$ and $z = (1, 1, 0)$, whereas in (c), we assume $y = (1, 1, 0)$ and $z = (0, 0, -1)$.

Proof (of Lemma 25.3) Without loss of generality, we suppose that y and z are both in C (see Fig. 15b). By Lemma 25.1, there exists $u \in \mathbb{U}_*^d$ such that $C = C(u, x)$, $\hat{C} = \hat{C}(u, x)$ and $\Gamma^d(x) \subseteq C \cup \hat{C}$. By Lemma 25.2, $y \in \Gamma^d(x)$ and $z \in \Gamma^d(x)$. Let $w \in \mathbb{Z}^d$ such that, for any i in $[1, d]$, $w_i = x_i - u_i$. It may be seen, from the definition of \hat{C} , that $w \in \hat{C} \setminus \{x\}$. Therefore, according to Lemma 25.2, $(x, w) \in \Gamma^d$. Since, y and z are in $C \setminus \{x\}$ and since $y \neq z$, there exist distinct i and j in $[1, d]$ such that $y_i = x_i + u_i$ and $z_j = x_j + u_j$. As $w_i = x_i - u_i$ and $w_j = x_j - u_j$, we deduce that there is no d -cube that contains both w and y and there is no d -cube that contains both w and z . Thus, neither (w, y) nor (w, z) belongs to Γ_d^d . Therefore, since $\Gamma^d \subseteq \Gamma_d^d$, we have $(w, y) \notin \Gamma^d$ and $(w, z) \notin \Gamma^d$. From the underlined relations, we deduce that $\{w, y, z\} \subseteq \Gamma^d(x)$. Furthermore, since Γ^d is a PFG, $\{w, y, z\}$ contains at most two connected components. Thus, from the underlined relations, we must have $(y, z) \in \Gamma^d$. \square

Proof (of Lemma 25.4) If y and z are not d -adjacent (i.e., $(y, z) \notin \Gamma_d^d$), it is sufficient to note that $\Gamma^d \subseteq \Gamma_d^d$ to complete the proof. Suppose now that y and z are d -adjacent (see Fig. 15c). By Lemma 25.1, there

exists $u \in \mathbb{U}_*^d$ such that $C = C(u, x)$, $\hat{C} = \hat{C}(u, x)$ and $\Gamma^d(x) \subseteq C \cup \hat{C}$. Since $y \in C$ and $y \neq x$, there exists $i \in [1, d]$ such that $y_i = x_i + u_i$. Since $z \in \hat{C}$, $z_i = x_i$ or $z_i = x_i - u_i$ but, since y and z are d -adjacent, $z_i = x_i$. Using the same arguments, we may notice that there exists $j \neq i$ such that $z_j = x_j - u_j$ and $y_j = x_j$. We set $w \in \mathbb{Z}^d$ such that $w_i = x_i + 2u_i$ (which is also equal to $y_i + u_i$) and $w_k = y_k$ for any $k \in [1, d] \setminus \{i\}$. We also set $v \in \mathbb{Z}^d$ such that $v_j = x_j + u_j$ and $v_k = x_k$ for any $k \in [1, d] \setminus \{j\}$. By the very definition of C , we have $v \in C$, which, by Lemma 25.3, implies $(v, y) \in \Gamma^d$. It may be seen that $(w, y) \in \Gamma_1^d$. Thus, since $\Gamma_1^d \subseteq \Gamma^d$, we have $(w, y) \in \Gamma^d$. As $w_i = x_i + 2u_i$ and $v_i = x_i$ (since $i \neq j$), we deduce that $(v, w) \notin \Gamma_d^d$. Therefore, since $\Gamma^d \subseteq \Gamma_d^d$, we have $(v, w) \notin \Gamma^d$. With the same arguments, we obtain the relation $(w, z) \notin \Gamma^d$. Furthermore, as $v_j = x_j + u_j$ and $z_j = x_j - u_j$, we have $(v, z) \notin \Gamma_d^d$. Hence, from $\Gamma^d \subseteq \Gamma_d^d$, we deduce $(v, z) \notin \Gamma^d$. If $(y, z) \in \Gamma^d$, from the underlined observations, we would have $\{v, w, z\} \subseteq \Gamma^d(y)$ and $\{v, w, z\}$ would be made of three connected components, which, by Theorem 2.iii, is a contradiction with Γ^d is a PFG. Thus, $(y, z) \notin \Gamma^d$. \square

5 Line graphs

In image analysis, we are sometimes interested by segmentations which do not consider graph vertices to separate regions. Instead, a segmentation is considered as a partition of the vertex set into connected classes. In this case, the regions are the classes of the partition and the separation between them is made of the edges which link vertices belonging to distinct classes. For instance, in Fig. 16a, the vertex set is partitioned into three classes depicted with three different gray levels. The set of edges depicted in bold represent the separation between these three classes. In many cases, this framework also falls in the scope of our study thanks to the notion of a *line graph*, which is well-known in graph theory (see e.g. [18]). In this section, we recall the definition of a line graph and present three properties which link line graphs, perfect fusion graphs and perfect fusion grids.

Informally, the line graph of a graph G is a graph whose vertex set corresponds to the edge set of G and for which two vertices are adjacent if the corresponding edges in G share a common vertex.

Definition 29 (line graph) *Let (E, Γ) be a graph. The line graph of (E, Γ) is the graph (E', Γ') such that $E' = \{\{x, y\}, (x, y) \in \Gamma\}$ and (u, v) belongs to Γ' whenever $u \in E', v \in E', u \neq v$ and $u \cap v \neq \emptyset$.*

Let (E', Γ') be a graph. We say that (E', Γ') is a line

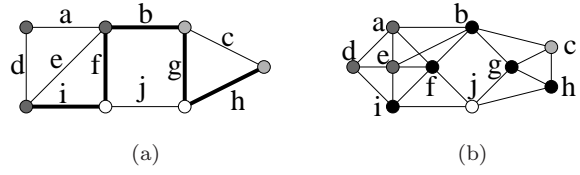

Fig. 16 (a): A graph (E, Γ) and a partition of E into three classes represented by distinct gray level. (b): The line graph of (E, Γ) .

graph if there exists a graph (E, Γ) such that (E', Γ') is isomorphic to the line graph of (E, Γ) .

For instance, the graph G' (Fig. 16b) is the line graph of G (Fig. 16a). Observe that the separation made of the bold edges in G correspond to a separation made of vertices (depicted in black in Fig. 16) in G' . Therefore, by the means of line graphs, the framework settled in this paper can be applied to separations made of edges rather than vertices (under the restriction that each connected component induced by the separating set of edges is made of at least one edge).

Property 30 (from Property 29 in [3])

- (i) *Any line graph is a perfect fusion graph.*
- (ii) *There exist perfect fusion graphs which are not line graphs.*

As an illustration, it can be verified that the graph in Fig. 16 is indeed a perfect fusion graph. Examples of perfect fusion graphs which are not line graphs can be found in [3].

Property 31 *Let $b \in \mathbb{B}^d$. The perfect fusion grid $(\mathbb{Z}^d, \Lambda_b^d)$ is a line graph. More precisely, $(\mathbb{Z}^d, \Lambda_b^d)$ is isomorphic to the line graph of $G = (\mathcal{C}, \Gamma)$ where \mathcal{C} is the chessboard $\mathcal{C}_b^d \cup \mathcal{C}_{\hat{b}}^d$ and where Γ is the set of all pairs $(C, \hat{C}) \in \mathcal{C} \times \mathcal{C}$ such that $C \neq \hat{C}$ and $C \cap \hat{C} \neq \emptyset$.*

Proof Let $G' = (E', \Gamma')$ be the line graph of G . We have to prove that G' is isomorphic to $(\mathbb{Z}^d, \Lambda_b^d)$. Since \mathcal{C} is a chessboard, by Theorem 20, for any point $x \in \mathbb{Z}^d$, there exists two d -cubes C and \hat{C} of \mathbb{Z}^d such that C and \hat{C} are the only two distinct elements of \mathcal{C} which contains x and such that $C \cap \hat{C} = \{x\}$. Let us define, for any $x \in \mathbb{Z}^d$, $f(x)$ as the set $\{C, \hat{C}\}$ where C and \hat{C} are the two distinct elements of \mathcal{C} such that $C \cap \hat{C} = \{x\}$. Thus clearly, from the above remark, f is a bijection from \mathbb{Z}^d to E' . Then, in order to establish Property 31, it suffices to prove that, for any x and y in \mathbb{Z}^d , $y \in \Lambda_b^d(x)$ if and only if $f(y) \in \Gamma'(f(x))$. Let x and y be any two elements of \mathbb{Z}^d .

1. Let us first suppose that $y \in \Lambda_b^d(x)$. Then, by definition of Λ_b^d , there exists a d -cube $C \in \mathcal{C}$ such

that x and y belong to C . Thus, by definition of f , there exist \hat{C}' and \hat{C}'' in \mathcal{C} such that $f(x) = \{C, \hat{C}'\}$ and $f(y) = \{C, \hat{C}''\}$. Hence, by definition of Γ' , $f(y) \in \Gamma'(f(x))$.

2. Let us now suppose that $f(y) \in \Gamma'(f(x))$. Then, by definition of Γ' , there exist three d -cubes C , \hat{C}' and \hat{C}'' in \mathcal{C} such that $f(x) = \{C, \hat{C}'\}$ and $f(y) = \{C, \hat{C}''\}$. By definition of f , $\{x\} = C \cap \hat{C}'$ and $\{y\} = C \cap \hat{C}''$. Thus x and y belong to C . Since $C \in \mathcal{C}$ and since $\mathcal{C} = \mathcal{C}_b^d \cup \mathcal{C}_b^d$, by definition of Λ_b^d , we deduce that $y \in \Lambda_b^d(x)$. \square

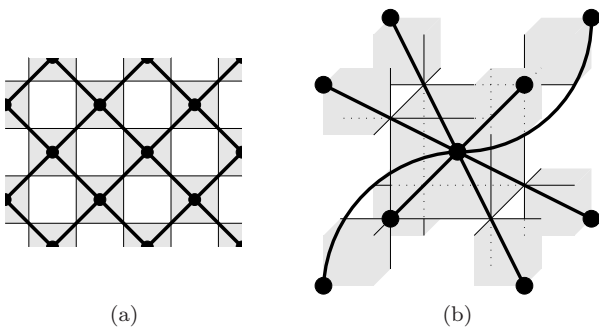

Fig. 17 Illustration of Property 31 [see text].

Property 31 is illustrated in Fig. 17. The gray squares in Fig. 17a represent a sample of a chessboard on \mathbb{Z}^2 . The graph represented in bold in Fig. 17a correspond to the graph G associated to the depicted chessboard and defined as in Property 31. It can be verified that the perfect fusion grid, associated to the depicted chessboard, is indeed isomorphic to the line graph of the graph in bold. The case of \mathbb{Z}^3 is illustrated in the same manner in Fig. 17b. Observe also that in the case of \mathbb{Z}^2 , the graph G is isomorphic to the graph induced by the direct adjacency relation Γ_1^2 . A similar statement is not true on \mathbb{Z}^3 . Indeed, on \mathbb{Z}^3 , any vertex of the graph G (defined as in Property 31) is adjacent to exactly eight vertices (see for instance Fig. 17b) whereas in the graph $(\mathbb{Z}^3, \Gamma_1^3)$ any vertex is adjacent to exactly six vertices (since each element of \mathbb{Z}^3 is included in exactly six distinct 1-cubes).

Theorem 21 establishes that the only PFGs which are “between” the direct and indirect adjacencies are the perfect fusion grids. Furthermore, as stated by the following corollary, the perfect fusion grids are also, in any dimension, the only line graphs “between” the direct and indirect adjacencies.

Corollary 32 *Let (\mathbb{Z}^d, Γ^d) be a graph such that $\Gamma_1^d \subseteq \Gamma^d \subseteq \Gamma_d^d$. The pair (\mathbb{Z}^d, Γ^d) is a line graph, if and only if it is a perfect fusion grid on \mathbb{Z}^d .*

Proof If (\mathbb{Z}^d, Γ^d) is a perfect fusion grid on \mathbb{Z}^d , then, by Property 31, it is a line graph.

Conversely, if (\mathbb{Z}^d, Γ^d) is a line graph, then by Property 30, it is a perfect fusion graph and, thus, by Theorem 21, it is a perfect fusion grid. \square

Conclusion

In [3], we set up a theoretical framework for the study of region merging in graphs. In particular, we introduced the perfect fusion graphs as the graph in which, for any set of regions (separated by a set of vertices), any two neighboring regions can be merged through their common neighborhood while preserving all other regions. This class of graphs permits, in particular, to rigorously define hierarchical schemes based on region merging and to implement them in a straightforward manner.

The graphs which are the most frequently used in image analysis, namely the direct and indirect adjacency graphs, are not perfect fusion graphs. Therefore, we introduced in [3] the perfect fusion grid, a regular graph which is indeed a perfect fusion graph and which is between the direct and indirect adjacency relations.

In this paper, we proved that the perfect fusion grid is the only such graph on \mathbb{Z}^d . This means that the perfect fusion grid is, in any dimension $d \in \mathbb{N}_*$, the only graph, “between” the direct and indirect adjacencies, which verify the property that any two neighboring regions can be merged through their common neighborhood while preserving all other regions.

In digital topology, there exists one result of unicity of an adjacency relation in arbitrary dimension. It is due to Kong [19] and, informally, it states that the only Alexandroff topology on \mathbb{Z}^d “between the direct and the indirect adjacency relations” is the topology proposed by Khalimsky [20].

References

1. Pavlidis, T.: Structural Pattern Recognition. Springer Series in Electrophysics. Springer (1977). Segmentation techniques, chapter 4–5
2. Rosenfeld, A., Kak, A.: Digital picture processing, vol. 2, chap. 10. Academic Press (1982). Section 10.4.2.d (region merging)
3. Cousty, J., Bertrand, G., Couprie, M., Najman, L.: Fusion graphs: Merging properties and watersheds. J. Math. Imaging Vis. **30**(1) (2008)
4. Meyer, F.: Un algorithme optimal de ligne de partage des eaux. In: Proc. of 8ème Congrès AFCET, pp. 847–859. Lyon-Villeurbanne, France (1991)
5. Kong, T., Rosenfeld, A.: Digital topology: Introduction and survey. Computer Vision Graphics and Image Processing **48**(3), 357–393 (1989)

6. Klette, R., Rosenfeld, A.: Digital Geometry: Geometric Methods for Digital Picture Analysis. Springer Series in Electrophysics. Morgan Kaufmann (2004). Chapter 2: Grids and digitization
7. Cousty, J., Najman, L., Bertrand, G., Couprie, M.: Weighted fusion graphs: merging properties and watersheds. *Discrete Appl. Math.* **156**(15), 3011–3027 (2008)
8. Cousty, J., Bertrand, G.: A uniqueness property of perfect fusion grids. In: S. Alayrangues, G. Damiand, L. Fuchs, P. Lienhardt (eds.) 1st Workshop on Computational Topology in Image Context (CTIC'08) (2008)
9. Digabel, H., Lantuéjoul, C.: Iterative algorithms. In: Proc. 2nd European Symp. Quantitative Analysis of Microstructures in Material Science, Biology and Medicine, pp. 85–89 (1978)
10. Vincent, L., Soille, P.: Watersheds in digital spaces: An efficient algorithm based on immersion simulations. *IEEE Trans. Pattern Anal. Mach. Intell.* **13**(6), 583–598 (1991)
11. Couprie, M., Bertrand, G.: Topological grayscale watershed transform. In: Proc. of SPIE Vision Geometry V, vol. 3168, pp. 136–146 (1997)
12. Bertrand, G.: On topological watersheds. *Journal of Mathematical Imaging and Vision* **22**(2-3), 217–230 (2005)
13. Bleau, A., Leon, L.J.: Watershed-based segmentation and region merging. *Comput. Vis. Image Underst.* **77**(3), 317–370 (2000)
14. Beucher, S.: Watershed, hierarchical segmentation and waterfall algorithm. In: Proc. of the second international conference on Mathematical Morphology and its Applications to Image Processing, pp. 69–76 (1994)
15. Meyer, F.: The dynamics of minima and contours. In: Mathematical Morphology and its Application to Image and Signal Processing, pp. 329–336 (1996)
16. Najman, L., Schmitt, M.: Geodesic saliency of watershed contours and hierarchical segmentation. *IEEE Trans. Pattern Anal. Mach. Intell.* **18**(12), 1163–1173 (1996)
17. Bertrand, G., Couprie, M.: A model for digital topology. In: G. Bertrand et al. (ed.) *Discrete Geometry for Computer Imagery, Lecture Notes in Computer Science*, vol. 1568, pp. 229–241. Springer (1999)
18. Berge, C.: *Graphes et hypergraphes*. Dunod (1970)
19. Kong, T.: The Khalimsky topologies are precisely those simply connected topologies on \mathbb{Z}^n whose connected sets include all $2n$ -connected sets but no $(3n-1)$ -disconnected sets. *Theoretical Computer Science* **305**(1–3), 221 – 235 (2003). *Topology in Computer Science*
20. Khalimsky, D., Kopperman, R., Meyer, P.: Computer graphics and connected topologies on finite ordered sets. *Topology and its applications* **36**, 1–17 (1990)