



**HAL**  
open science

# Effect of Bituminous Pavement Structures on the Rolling Resistance

Olivier Chupin, Jean-Michel Piau, Armelle Chabot

► **To cite this version:**

Olivier Chupin, Jean-Michel Piau, Armelle Chabot. Effect of Bituminous Pavement Structures on the Rolling Resistance. 11th International Conference On Asphalt Pavements, Aug 2010, Nagoya Aichi, Japan. pp.1287-1296. hal-00508784

**HAL Id: hal-00508784**

**<https://hal.science/hal-00508784v1>**

Submitted on 16 Jul 2023

**HAL** is a multi-disciplinary open access archive for the deposit and dissemination of scientific research documents, whether they are published or not. The documents may come from teaching and research institutions in France or abroad, or from public or private research centers.

L'archive ouverte pluridisciplinaire **HAL**, est destinée au dépôt et à la diffusion de documents scientifiques de niveau recherche, publiés ou non, émanant des établissements d'enseignement et de recherche français ou étrangers, des laboratoires publics ou privés.

## Effect of Bituminous Pavement Structures on the Rolling Resistance

O. Chupin, J.-M. Piau, A. Chabot

Laboratoire Central des Ponts et Chaussées (LCPC, PRES UNAM), Route de Bouaye, BP 4129, 44341  
Bouguenais Cedex, France

**ABSTRACT:** For environmental reasons, the energy consumption of road traffic is an overwhelming question and so is the subsequent quantification of the power dissipation of a vehicle-road system. Among several sources of dissipation occurring at different levels of this system (aerodynamic forces, internal friction in the engine, etc), the present paper focuses on the power dissipation induced by the pavement itself, and more specifically by its constitutive behavior. As a matter of fact, the type of pavement (bituminous or rigid) is sometimes evoked as a factor that might affect the power dissipation. To the contrary of non-dissipative elastic materials which are preponderant in rigid pavements, the viscoelastic behavior of bituminous mixes indeed leads to power dissipation when solicited by a moving load. This raises the question of whether the power dissipation caused by asphalt pavements is significant or not. To address this issue, we quantify here, from a theoretical viewpoint, the impact of asphalt pavements on the structure-induced rolling resistance (RR). Texture effects are not accounted here. The power dissipation is first computed using the mechanical response of pavements under moving loads. It is then converted into a rolling resistance force. Both these quantities are quantified by applying the developed method to a typical thick asphalt pavement. Furthermore, the influence of temperature on the structure-induced RR is analyzed. Under the considered assumptions, it is shown that the mechanical behavior of asphalt pavements leads to a negligible contribution to the RR.

**KEY WORDS:** Rolling resistance, asphalt pavement, moving load, power dissipation, viscoelasticity.

### 1 INTRODUCTION

The energy available in the fuel of a vehicle is mostly used for climbing slopes and acceleration as well as for getting over the rolling resistance, the air resistance (air drag), the internal friction (or other vehicle-caused dissipation). The ratio of these to the total resistance depends upon the vehicle speed. For instance, air drag increases with speed to the contrary of the rolling resistance (Beuving et al. 2004, see also Figure 1). Beside, other studies (Glaeser 2005) have shown that the rolling resistance ( $F_{RR}$  in Figure 1) is about 1% of the weight of a vehicle. The rolling resistance is itself a result of the contribution of the pavement structure, the micro- and the macro-texture, evenness and tire effects.

The present study focuses on the structural component of the rolling resistance for moving loads traveling on a flat pavement surface. The underlying question is whether the mechanical response of a dissipative asphalt pavement yields more rolling resistance than a rigid pavement which is assumed to be quasi-elastic and non-dissipative. The effect of the

pavement micro- and macro-texture is not accounted here (for results on the effect of road surface properties, see e.g. Igwe et al. 2009). In the past, experimental studies have tried to answer the aforementioned question with more or less success because of the difficulty to dissociate the effect of the structure on the rolling resistance. In this paper, the problem is approached from a theoretical viewpoint and we propose a method to derive the structure-induced rolling resistance of a vehicle traveling on a multilayered asphalt pavement. Quantitative results are given through an application to a thick asphalt pavement.

The paper is outlined as follows: section 2 presents theoretical considerations for the calculation of the structure-induced RR and the numerical modeling used for its computation. Section 3 is devoted to the application to a thick asphalt pavement under two loading configurations. The impact of asphalt pavements on the RR is then discussed based on the computed results. Finally, conclusions are drawn in section 4.

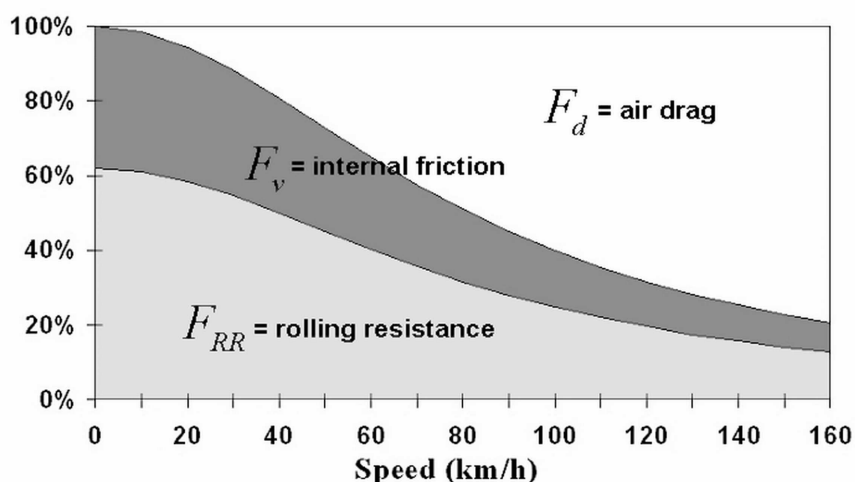

Figure 1: Force distribution in a passenger car versus speed as a percentage of the available power output at the crankshaft (source: Beuving et al. 2004).

## 2 THEORETICAL CALCULATION OF THE STRUCTURE-INDUCED RR

This section first presents the assumptions of the problem and the theoretical formula utilized to calculate the structure-induced RR of a vehicle traveling on a layered medium that incorporates viscoelastic behavior. The rolling resistance force ( $F_{RR}^{str}$ ) generated by a structural effect is obtained from the power dissipation ( $\phi_{RR}^{str}$ ) which is itself based on the calculation of the deflection at the pavement surface. The numerical procedure that enables the computation of the deflection and the power dissipation are introduced later in this section prior to the viscoelastic constitutive model used to represent asphalt pavement materials.

### 2.1 Assumptions of the Problem and Derivation of the $\phi_{RR}^{str}$ and $F_{RR}^{str}$ Formulas

The pavement considered here is a multilayered structure whose layers have either a linear elastic (for soil and non-bituminous materials) or viscoelastic (for asphalt materials) behavior. The vehicle's tires are supposed to be non-dissipative and a quasi-static regime is assumed. That is the vehicle is supposed to move at the constant speed  $V$  and the pavement is viewed as a semi-infinite medium homogeneous in the driving direction. According to this

assumption, any mechanical field  $f(x, y, z, t)$  can be expressed in the load frame as a function  $f^*(X, y, z)$  with  $x = X + Vt$ . Moreover, the derivatives verify the relation:  $\partial f / \partial t = V \partial f^* / \partial X$ .

Let us consider one wheel of the vehicle loaded by a vertical force applied to its axle. In order to maintain the quasi-static regime a “driving” force and a possible moment (in the case of a driving wheel) must be applied to the wheel axle (see Figure 2). This results in a horizontal force  $T_{RR}^{str}$  and a moment  $M_{RR}^{str}$  which are representative of the rolling resistance. For a towed wheel,  $M_{RR}^{str}$  would be equal to zero.

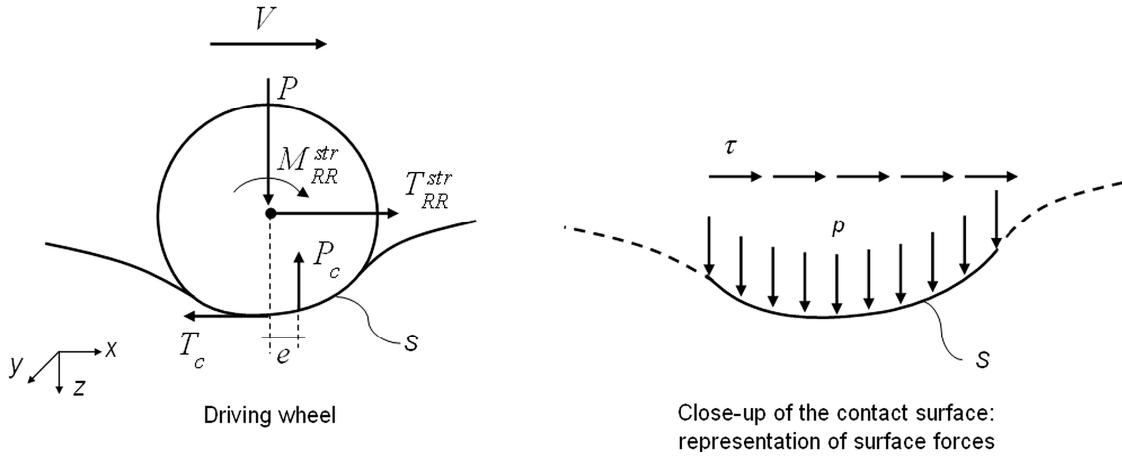

Figure 2: Diagram of resulting forces applied to the wheel.

According to the preceding considerations, the power dissipation due to a structural effect can be expressed as follows:

$$\wp_{RR}^{str} = T_{RR}^{str} V + M_{RR}^{str} \omega = F_{RR}^{str} V \quad (1)$$

where  $\omega$  denotes the angular velocity of the wheel.  $F_{RR}^{str}$  represents the global rolling resistance force that we are interested in, and which is effective for both cases of a towed and a driving wheel. Indeed, for a given travel distance  $L$ , the energy consumption imputable to a structural effect would be:  $E_{RR}^{str} = \wp_{RR}^{str} L / V = F_{RR}^{str} L$ . For the determination of  $\wp_{RR}^{str}$ , let us reformulate equation (1) by using the contact forces at the pavement-tire interface. These can be represented by two resultant forces,  $T_c$  and  $P_c$ , as shown in Figure 2. Note that  $P_c$  is offset by a distance  $e$  from the wheel axis so that the dynamical balance of moment of forces is respected for the wheel (i.e. equal to zero for a constant  $\omega$ ). Let us also assume that the contact forces are associated to a distribution of vertical pressure and shear stress,  $p$  and  $\tau$ , acting on the tire imprint ( $S$ ):

$$T_c = -T_{RR}^{str} = -\tau S, \quad P_c = -P = -pS \quad (2)$$

Now, considering the first law of thermodynamics applied to the wheel yields:

$$\wp_{RR}^{str} + \wp_c = \frac{d}{dt} (K_{wheel} + E_{wheel}) \quad (3)$$

However, the derivative of the kinetic energy ( $K_{wheel}$ ) with respect to time is equal to zero on account of the quasi-static assumption. Besides, the rate of internal energy ( $E_{wheel}$ ) is also nil under the assumption of a non-dissipative tire. Finally, the right hand side in equation (3) is zero and one has:  $\mathcal{P}_{RR}^{str} = -\mathcal{P}_c$ . Assuming no slip at the tire-pavement contact leads to:

$$\vec{v}_{wheel}(Q) = \vec{v}_{pavement}(Q) \quad (4)$$

for any point  $Q$  that belongs to the contact surface.  $\vec{v}_{wheel}(Q)$  and  $\vec{v}_{pavement}(Q)$  are the velocity vectors of point  $Q$  for the wheel and the pavement, respectively. The structure-induced power dissipation due to rolling of the wheel then reads:

$$\mathcal{P}_{RR}^{str} = -\mathcal{P}_c = \int_S \tau \frac{du(x, y, z, t)}{dt} dS + \int_S p \frac{dw(x, y, z, t)}{dt} dS \quad (5)$$

with  $u$  and  $w$  being the horizontal ( $x$  direction) and the vertical components of the displacement field of the pavement surface (similar to those of the wheel). Equation (5) relates the fact that the structure-induced power dissipation is equal to the power of the contact forces.

In subsequent calculations, it is assumed that the power of horizontal surface forces ( $\tau$ ) can be neglected so that only  $p$  needs to be considered in the definition of contact forces. This assumption will be verified a posteriori (see section 3.3). Considering now the quasi-static assumption and using the divergence theorem to transform surface integrals in equation (5) into integrals over the contour of the loaded area ( $\Gamma$ ) yields:

$$\mathcal{P}_{RR}^{str} = \int_S p \frac{dw(x, y, z, t)}{dt} dS = pV \int_S \frac{\partial w^*(X, y, z)}{\partial X} dS = pV \int_{\Gamma} w^*(X, y, z) \cdot n_X dl \quad (6)$$

where  $n_X$  is the  $X$ -component of the outward unit normal to contour  $\Gamma$ , that encloses the tire imprint. In equation (6) assumes that  $p$  is homogeneous. Finally, the rolling resistance force due to a structural effect reads:

$$F_{RR}^{str} = p \int_{\Gamma} w^*(X, y, z) \cdot n_X dl \quad (7)$$

Equations (6) and (7) show that the calculation of  $\mathcal{P}_{RR}^{str}$  and  $F_{RR}^{str}$  requires the determination of the displacement field at the free surface of the viscoelastic pavement solicited by moving loads, that is the deflection. Note also that in addition to the coordinates ( $X, y, z$ ) the deflection depends upon the pavement structure, the material properties, the temperature ( $\theta$ ), and the velocity even though it does not appear in equation (6) and (7). Therefore,  $F_{RR}^{str}$  is still a function of speed because of the dependency of the deflection to  $V$ .

Now considering the case of multiple loads, equation (6) can be extended as follows:

$$\wp_{RR}^{str}(G) = V \sum_{i=1}^{nloads} p_i \int_{\Gamma_i} w^*(X, y, z) \cdot n_x dl \quad (8)$$

where  $w^*$  accounts for the interaction between loads.  $nloads$  is the number of loads and  $\Gamma_i$  represents the contour of the  $i$ th tire imprint. For independent groups of interacting loads, i.e. for groups of loads that, in regards to the deflection, do not interact significantly between themselves (e.g. the left and the right side of a wheel axle),  $\wp_{RR}^{str}$  can be approximated as follows:

$$\wp_{RR}^{str}(G) \approx \sum_{g=1}^{ngroups} \wp_{RR}^{str}(G_g) \quad \text{with} \quad G_g = \bigcup_{i=1}^{nloads} (\Gamma_g)_i \quad (9)$$

$G_g$  denotes the  $g$ th independent group of loads and  $ngroups$  is the total number of  $G_g$ .  $(\Gamma_g)_i$  is the  $i$ th tire imprint of the independent group  $g$ . This property is used in the application to derive the structure-induced power dissipation for a 400kN truck from  $\wp_{RR}^{str}$  produced by a semi-axle load of 65kN.

The method used to compute the deflection, the power dissipation and the rolling resistance force are exposed in section 2.2.

## 2.2 Numerical Calculation of the Deflection and the Structure-Induced RR

In the following application, the deflection ( $w^*$ ) in equation (6) is obtained using the ViscoRoute© 2.0 software (free download on the LCPC website: [www.lcpc.fr](http://www.lcpc.fr)). ViscoRoute© 2.0 is a numerical program that was developed at LCPC, in collaboration with UR Navier (ENPC), to calculate the response of a viscoelastic layered structure to moving loads. ViscoRoute© 2.0 accounts for inertia forces and it enables to consider sliding (Chupin and Chabot 2010) or bonded conditions (Duhamel et al. 2005; Chabot et al. 2010) at the interface between layers. ViscoRoute© 2.0 first searches a solution of the problem in the frequency domain ( $(p, q)$  Fourier transforms in the  $X$  and  $y$  directions). The solution in the spatial domain is then obtained by means of Fast Fourier Transform (FFT) in order to inverse the solution calculated in the  $(p, q)$  spatial frequency domain.

Numerical fields in ViscoRoute© 2.0 are computed at points of the rectangular grid used in the FFT computations. This mesh is not user-defined but automatically established during the running of the program in order to check convergence criteria of the built-in methods. Consequently, the grid points do generally not locate on the load contour on which the integral in equation (6) must be computed. To interpolate the numerical fields (the deflection herein) on a load contour, we use the Shannon theorem.

Once the deflection has been computed on the load contour, the integral in the right hand side of equation (6) is calculated using a Gauss-Legendre quadrature rule. As illustrated in Figure 3, only rectangular-shaped loads are considered in this paper. Contours parallel to the  $y$ -axis ( $n_x = \pm 1$ ) are discretized in subintervals and a 2-point rule is applied on each of them. The contours parallel to the  $X$ -axis do not intervene in this calculation ( $n_x = 0$ )

In the case of multiple loads, ViscoRoute© 2.0 computations are performed considering all the loads (with cumulative effects for the deflection) and the Shannon theorem is applied to every load contour parallel to the  $y$ -axis.  $\wp_{RR}^{str}$  is then obtained using equation (8). For

several independent groups of interacting loads, equation (9) is further used to get the global  $\delta \mathcal{D}_{RR}^{str}$ .

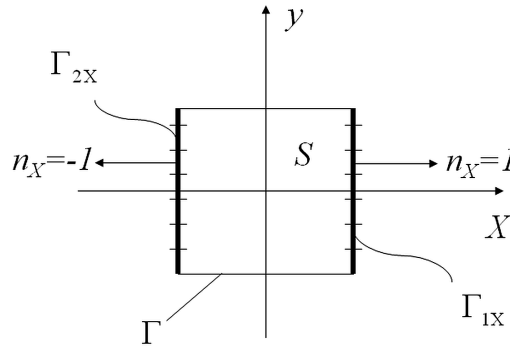

Figure 3: Discretization of a load imprint (the integration for the determination of  $\delta \mathcal{D}_{RR}^{str}$  is performed on  $\Gamma_{1x} \cup \Gamma_{2x}$ ).

### 2.3 Viscoelastic Model for Asphalt Materials

The Huet-Sayegh model (Huet 1963, Sayegh 1965) is used in ViscoRoute© 2.0 to take into account viscoelasticity of asphalt materials. This model is represented by a purely elastic spring connected in parallel to two parabolic dampers in series with an elastic spring, as sketched in Figure 4.

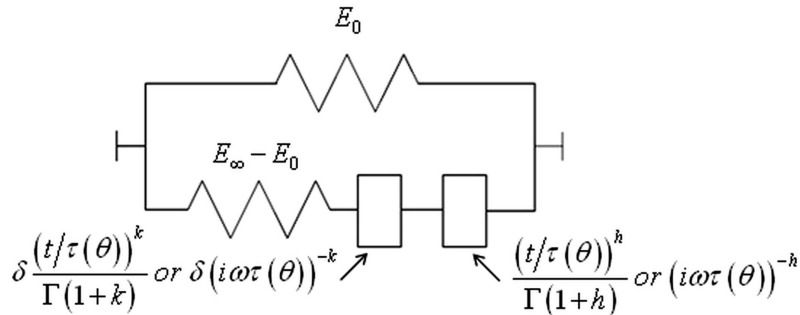

Figure 4: Schematic of the Huet-Sayegh model (creep function and complex modulus of temperature-dependent parabolic dampers).

The complex modulus of the Huet-Sayegh model reads:

$$E^* = E_0 + \frac{E_\infty - E_0}{1 + \delta (i\omega\tau(\theta))^{-k} + (i\omega\tau(\theta))^{-h}} \quad (10)$$

$E_0$  is the static elastic modulus,  $E_\infty$  is the instantaneous elastic modulus,  $k$  and  $h$  are exponents of the parabolic dampers ( $1 > h > k > 0$ ), and  $\delta$  is a positive non-dimensional coefficient.  $\theta$  denotes the temperature and  $\tau$  is a response time parameter governed by:

$$\tau(\theta) = \exp(A_0 + A_1\theta + A_2\theta^2) \quad (11)$$

where  $A_0$ ,  $A_1$  and  $A_2$  are constant parameters.

The parameters of the Huet-Sayegh model are fitted from the master curves stemming from complex modulus tests. The fitting procedure is done using the Viscoanalyse software developed at LCPC (Chailleux et al. 2006). For the asphalt concretes (AC 0-10 and AC 0-14) used in the application of section 3, the Black and the Cole-Cole diagrams are shown in Figure 5 on which solid lines represent the model results calculated using the identified parameters. The difference between the experimental data and the model results is more pronounced in the Black diagram. In spite of that the values of the fitted parameters remain satisfying.

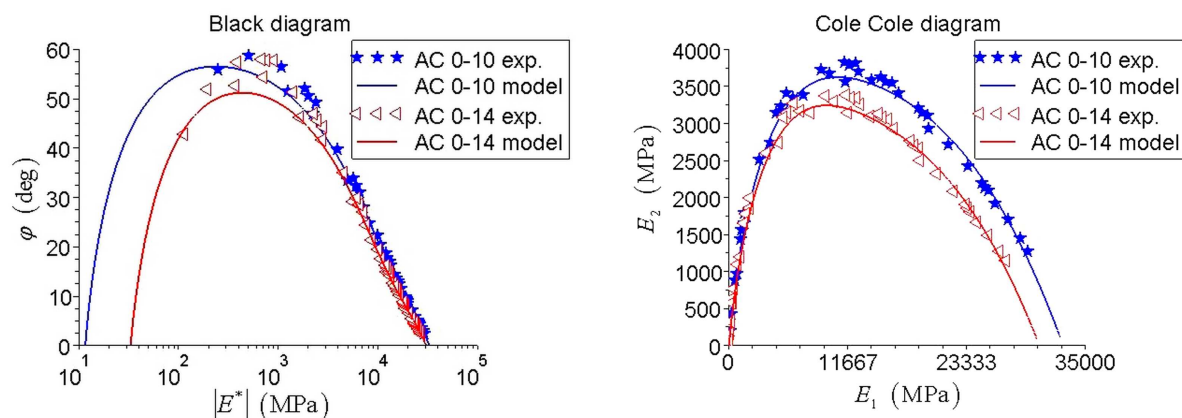

Figure 5: Master curves for two asphalt pavement concretes.

The value of the Huet-Sayegh parameters corresponding to the above plots is summarized in Table 1.

Table 1: Value of the Huet-Sayegh parameters (LCPC ref. #Aff450).

	$E0$ (MPa)	$Einf$ (MPa)	$\delta$	$k$	$h$	$A0$ (s)	$A1$ (s °C <sup>-1</sup> )	$A2$ (s °C <sup>-2</sup> )
AC 0-10	11	32836	2.32	0.23	0.69	3.5059	-0.3713	0.00157
AC 0-14	33	30501	2.23	0.21	0.66	3.9982	-0.3747	0.00175

### 3 CALCULATION OF $\wp_{RR}^{str}$ AND $F_{RR}^{str}$ FOR A THICK ASPHALT PAVEMENT

In this section, the previous developments are applied to the case of a typical thick asphalt pavement as designated for heavy traffic roads. The structure-induced power dissipation and rolling resistance are computed for different conditions taking into account the influence of temperature.

#### 3.1 Pavement Structure Used for the Assessment of $\wp_{rol}^{str}$ and $F_{rol}^{str}$

A typical thick asphalt pavement is composed of four layers which are defined as follows: a surface course of bituminous materials (AC 0-10), two base layers of bituminous materials (AC 10-14) and a pavement foundation.

Figure 6 depicts the pavement structure. The layers made up of bituminous materials are



represented by the Huet-Sayegh model whose parameters are given in Table (1) for the asphalt concretes used in the three top layers. The pavement foundation is assumed to be non-dissipative and to follow Hooke's law. Poisson's ratio is constant and equal to 0.35 for all the layers.

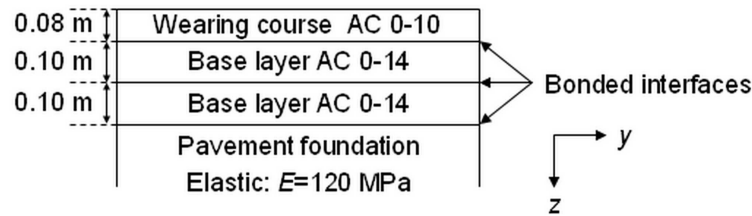

Figure 6: Thick asphalt pavement considered herein.

### 3.2. Loading Configurations

The power dissipation is computed for representative loads typical of real heavy truck axles also used in pavement design. One is a tandem axle and the other one is a dual tire configuration. Figure 7 displays, for the aforementioned representative loads, the dimensions of the tire imprints and the distance between them. Each load represents a force of 32.5kN what corresponds to a uniform pressure distribution equal to 0.662MPa. The load speed is set to 20m/s. The extrapolation to an entire vehicle is obtained using equation (9) and by considering several groups of such representative half-axes.

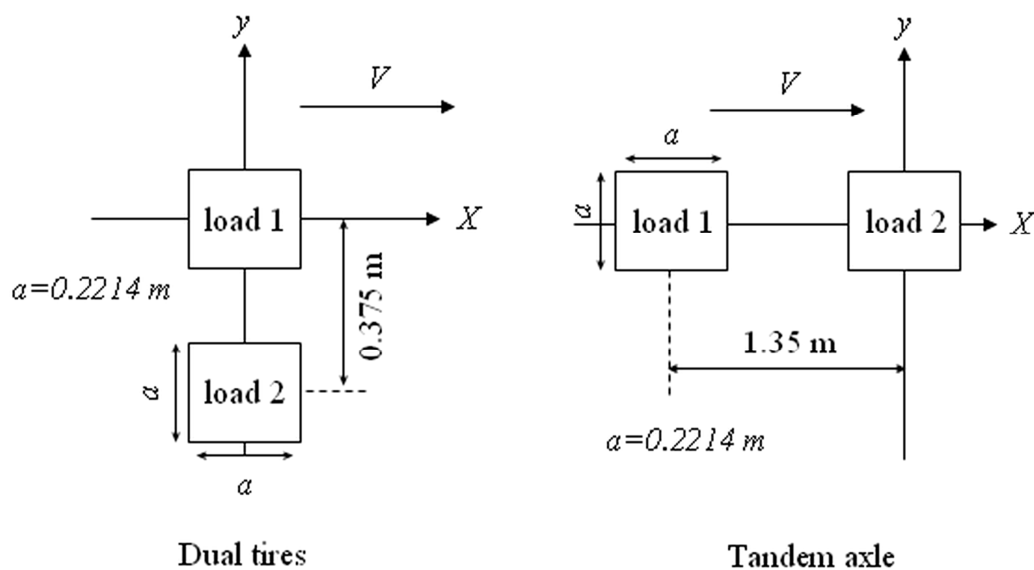

Figure 7: Tire imprints for the dual tire and the tandem axle configurations.

### 3.3 Quantification of $\phi_{RR}^{str}$ and $F_{RR}^{str}$

The power dissipation and the rolling resistance are computed for the structure depicted in Figure 6 and the two loading configurations detailed in section 3.2. To accomplish this, equation (8) is used after the ViscoRoute© 2.0 simulations and the Shannon theorem have been run.  $\phi_{RR}^{str}$  and  $F_{RR}^{str}$  are computed for the representative loads of Figure 7 and then extrapolated to a whole truck of 40 tons.

The results are presented in Figure 8 that shows the evolution of  $\phi_{RR}^{str}$  (resp.  $F_{RR}^{str}$ ) as a function of the temperature within the asphalt layers. First, Figure (8) indicates that the structure-induced power dissipation (resp.  $F_{RR}^{str}$ ) computed for the tandem axle configuration is close to that of the dual tire configuration. It also shows that the evolution of  $\phi_{RR}^{str}$  (resp.  $F_{RR}^{str}$ ) is exponential-like with respect to the pavement temperature. However, the main result is that even at 40°C, the structure-induced rolling resistance force is less than 150N and  $\phi_{RR}^{str}$  is lower than 3000W. Let us compare these figures with two characteristic values of the problem. The rolling resistance force caused by a structural effect can be compared to the value of the global rolling resistance ( $F_{RR}$ ) which, as previously mentioned, is about 1% of the vehicle weight. Thus, for a 400kN truck  $F_{RR}$  is about 4000N and  $F_{RR}^{str}$  is less than 4% of the global rolling resistance. This attests that the contribution of the pavement structure to  $F_{RR}$  is almost imperceptible. Another way to appraise the structure-induced rolling resistance is to compare  $\phi_{RR}^{str}$  to the engine power output, say 450hp (slightly more than 330kW) in the present case. Then, the structure-induced power dissipation is less than 1% of the engine power output. Again this figure is quite small.

Note that, although not presented here, similar orders of magnitude were computed for other types of bituminous pavements for which the previous conclusions are thus valid.

Therefore, one can say that the substantial difference in rolling resistance between asphalt and rigid pavements observed in some studies cannot be explained by a structural effect.

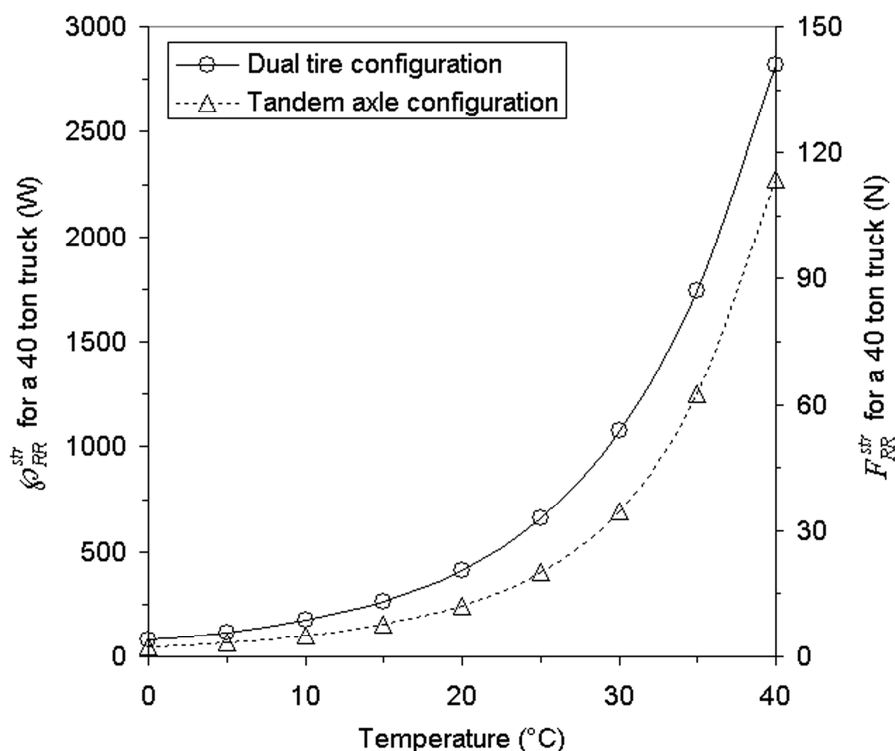

Figure 8: Evolution of the structure-induced power dissipation and rolling resistance force as a function of temperature for a 40-ton truck.

Remark: in section 2, we assumed that the horizontal surface forces could be neglected in the computation of the pavement response. This assumption can now be justified. Indeed,

combining equations (1) and (2), it enables to derive the equality  $\tau = \varphi_{RR}^{str}/SV$  for a towed wheel and the inequality  $\tau < \varphi_{RR}^{str}/SV$  for a driving wheel, which in both cases verify:  $\tau/p < 0.04\%$ .

#### 4 CONCLUSION

We presented in this paper a method to derive the structure-induced RR of a vehicle driving on a bituminous pavement. By structure-induced dissipation we meant the dissipation owing only to the thermo-viscoelastic behavior of asphalt layers that composed a bituminous pavement. All other effects were not considered in this study.

The evolution of the power dissipation as a function of temperature was presented; higher temperatures leading to greater power dissipation.

The concluding remarks are as follows: (i) under the model assumptions, even at high temperature (40°C), the structure-induced power dissipation of a 40 ton truck traveling on a thick asphalt pavement is no more than 1% of the engine power output. In terms of resistance force, this corresponds to less than 4% of the global rolling resistance. (ii) Similar orders of magnitude can be derived for other types of asphalt pavements. (iii) Finally, under the considered assumptions it appears that the viscous response of bituminous pavements does not affect significantly power dissipation of road traffic.

#### REFERENCES

- Beuving, E., De Jonghe, T., Goos, D., Lindahl, T., Stawiarski, A., 2004. *Fuel Efficiency of Road Pavements*. 3<sup>rd</sup> Eurasphalt & Eurobitume Congress, Vienna.
- Chabot, A., Chupin, O., Deloffre, L., Duhamel, D., 2010. *Viscoroute© 2.0: a Tool for the Simulation of Moving Load Effects on Asphalt Pavement*. Road Materials and Pavement Design (Special Issue: Recent Advances in Numerical Simulation of Pavements).
- Chailleux, E., Ramond, G., Such, C., de la Roche, C., 2006. *A Mathematical-Based Master-Curve Construction Method Applied to Complex Modulus of Bituminous Materials*. Roads Materials and Pavement Design 7 (EATA Special Issue), 75-92.
- Chupin, O., Chabot, A., 2010. *Influence of Sliding Interfaces on the Response of a Viscoelastic Pavement*. Proceedings of the 6th International Conference on Maintenance and Rehabilitation of Pavements and Technological Control (MAIREPAV6), Politecnico Di Torino, Italy.
- Duhamel, D., Chabot, A., Tamagny, P., Harfouche, L., 2005. *ViscoRoute: Visco-elastic Modeling for Asphalt Pavements*. Bulletin des Laboratoires des Ponts et Chaussées (<http://www.lcpc.fr/en/sources/blpc/index.php>), 258-259, 89-103.
- Glaeser, K.-P., 2005. *Measurements of Rolling Resistance of Tyres on Road Surfaces*. IEA Workshop, Paris, November 15-16.
- Huet, C., 1963. *Etude par une Méthode d'Impédance du Comportement Viscoélastique des Matériaux Hydrocarbonés*. Université de Paris (France), Ph.D. thesis.
- Igwe, E.A., Ayotamuno, M.J., Okparanma, R.N., Ogaji, S.O.T., Probert, S.D., 2009. *Road-Surface Properties Affecting Rates of Energy Dissipation from Vehicles*. Applied Energy, 86, 1692–1696.
- Sayegh, G., 1965. *Contribution à l'Etude des Propriétés Viscoélastiques des Bitumes Purs et des Bétons Bitumineux*. Faculté des Sciences de Paris (France), Ph.D. thesis.