

# ON-LINE MONITORING STATION FOR ENERGY DIAGNOSIS IN BUILDINGS

Benjamin Paris, Thierry Talbert, Julien Eynard, Stéphane Grieu, Adama Traoré  
and Monique Polit

ELIAUS Laboratory, University of Perpignan Via Domitia, 52 avenue Paul Alduy, 66860,  
Perpignan, France

*benjamin.paris@univ-perp.fr; talbert@univ-perp.fr; julien.eynard@univ-perp.fr;  
grieu@univ-perp.fr; traore@univ-perp.fr; polit@univ-perp.fr*

## ABSTRACT

Energy consumption in buildings is currently a real problem. That is why both assessment of energy performance and effective energy management are essential. In this context, the present paper focuses on developing a commercial monitoring station (BEMS) with the support of three industrial partners, Apex-BP Solar, Pyrescom and the "Centre Scientifique et Technique du Bâtiment" (CSTB). This device is designed for (i) on-line monitoring environmental and energetic parameters, (ii) on-line computing a global energy indicator, (iii) estimating the renewable energy resource of the location and (iv) advanced heating control.

## INTRODUCTION

Buildings consume a huge amount of energy. More precisely in France, it represents 46 % of the global energy consumption and 25 % of the green house gases emission (Ademe, 2007). To remedy to this problem, the EU Directive "Energy Performance of Building" (EPBD) (Official Journal, 2002) focusing on energy use in buildings and urging the members of the EU to improve energy efficiency, has been adopted. Several ways are suggested to promote energy savings, such as using efficient materials or fitting the design at the location. These recommendations are also explained in the French legal documentation "Réglementation Thermique 2005" (Journal Officiel, 2006) or "Diagnostic de performance énergétique" (Journal Officiel, 2006); they present all the parameters (environmental, energetic, materials, design...) that should be taken into account in order to define the energy characteristics of an existing building and to calculate various criteria (solar, inertia, thermal loss...). One of the most important enquiry is the global energy performance indicator explanation ( $\text{kWh}\cdot\text{m}^{-2}\cdot\text{year}^{-1}$ ), used in energy labels.

Energy performance assessment, management and enhancement are achieved using BEMS (Buildings Energy Management System) (Levermore, 2007, 1993). One of this system has been developed with our industrial partners Apex BP Solar, Pyrescom and the CSTB (Centre Scientifique et Technique du Bâtiment) to enhance the knowledge of the buildings behaviour and to control energy facilities, based on

documentation information. Then, our monitoring station has been installed at the Pyrescom headquarter and in a building mock-up (built at our laboratory), with the objective to model it. This BEMS carries out environmental and energetic data acquisition and treatment.

The main goal of this treatment is to perform an on-line energy diagnosis to highlight in real time the different energy consumptions expressed with the global energy indicator. In addition, renewable energy potentials are estimated using the stored environmental data. Moreover, the monitoring station allows an efficient energy management: thanks to several heating controllers, fossil energy consumption is reduced, promoting renewable energy and providing indoor comfort. These controllers are tested with MATLAB<sup>®</sup> simulations, using the mock-up model.

However, before developing concretely our BEMS, a preliminary study has been completed, by means of TRNSYS<sup>®</sup> simulations. The aim of these simulations is to comprehend what kind of energy audit is conceivable in a whole year and what parameters are essential.

The preliminary study is presented in a first section, while the BEMS's characteristics and the different buildings installations are exposed in the second section. The real applications (energy diagnosis, renewable energy potentials and heating controller simulations) are detailed in the third part.

## TRNSYS<sup>®</sup> SIMULATIONS

The TRNSYS<sup>®</sup> software is a significant help to improve the design of a BEMS. Indeed, it allows determining what parameters (energetic and environmental) are fundamentals to achieve an energy diagnosis. In addition, the energy audit can be performed for a whole year and the results are references for the future work. Moreover, this tool offers several functionalities (multi-zone approach, heating, cooling, lighting...), thus, a complete energy audit can be realised. Here, this work focuses on a thermal energy application to be synthetic and clear, i.e. an energetic audit with thermal energy consumption and solar thermal energy production.

First, let us note the building model used for the simulation, showed in figure 1.

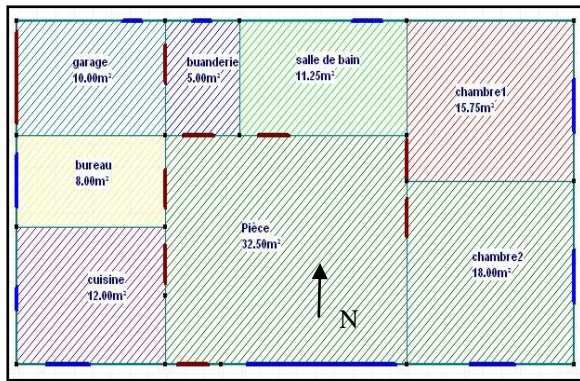

Figure 1. Building model.

This building model is designed according to bioclimatic concepts: the different rooms are located regarding geographical directions. For example, the occupants are usually in the kitchen in the evening, which is located at the west direction, where the sun goes down. The materials are the most common (concrete, plasterboard, tiled floor...). This model is not the main goal of this paper that is why the design will not be more detailed.

Concerning simulations for thermal application, the multi-zone approach leads to estimate the thermal energy consumption based on the temperature evolution in every room. Figure 2 presents the amount of the thermal energy consumption for all the rooms for a year and characterizes a kind of energy audit conceivable with a BEMS. Energy performance categories of buildings (benchmarks) are visible.

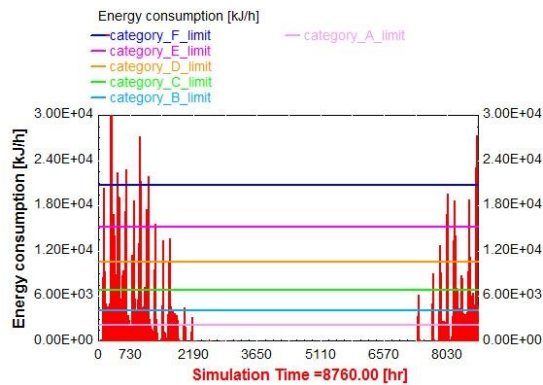

Figure 2. Energy consumption compared to energy performance categories.

Another example to improve the energy diagnosis is the estimation of the production of solar thermal equipment (figure 3). This point allows, in particular, comparison between thermal energy consumption and production in a same period, in a same place.

These simulation results are very simple examples of energy audit that could be achieved with a BEMS. Nevertheless, they are necessary to begin the monitoring station design and later, to confront the real acquisition with simulation results. Now, one needs present the BEMS configuration.

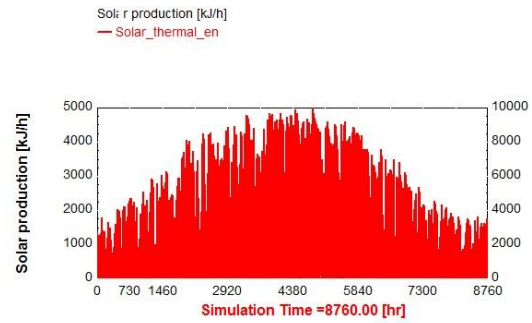

Figure 3. Solar thermal energy production.

## BEMS EXPERIMENT

### Monitoring station design

To establish a fair diagnosis of the energetic behaviour of a building and to assess energy performance, environmental and energetic data are needed.

Firstly, it is proposed to focus on various environmental factors. Indoor and outdoor temperatures are essential for buildings energy performance. Then, wind and solar radiation may help explaining many consumption levels or provide information about renewable energy availability, like performed with TRNSYS® simulations. Finally, indoor relative humidity represents a specific comfort parameter and, thus, affects the users' behaviour.

Secondly, buildings use various energies with a large emphasis on electricity. In the case of several kinds of energies (fuel, gas, electricity...), computation rules exist to estimate the individual contributions to the global energy performance indicator ( $\text{kWh}\cdot\text{m}^{-2}\cdot\text{year}^{-1}$ ). The following list summarizes the main sources of energy consumed in buildings:

- Electricity (includes heating, air conditioning system ...),
- Specific electricity (electricity that cannot be substituted by any other type of energy),
- Cooling and ventilation energy,
- Heating energy (precluding electricity): fuel oil, gas or wood.

Both the acquisition and the treatment of the above-mentioned variables require the choice of appropriate electronics (Paris et al., 2008). However: (i) implementation has to be easy and (ii) the total cost has to remain rather low (in order to generalize the production of the BEMS shown in figure 4).

The prototype has been developed with our previously-mentioned industrial partners and is composed of two parts (figure 5): (i) a core-block (including a low power processor, corresponding memory, and integrated hosts controllers), and (ii) a set of adaptable bloc sensors, which means that it is possible to record and process different data.

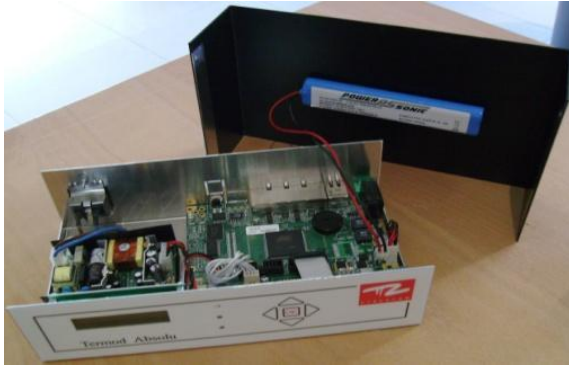

Figure 4. BEMS prototype.

Because it is linear ( $10\text{mV}\cdot^{\circ}\text{C}^{-1}$ ), small, easy to install and cheap, the selected sensor for the temperature acquisition is the LM35. Its accuracy is  $\pm 0.5^{\circ}\text{C}$  and its range stretches from  $-55^{\circ}\text{C}$  to  $+150^{\circ}\text{C}$ . Then, the HIH\_400, used for its robustness, measures the relative humidity with an accuracy of  $\pm 3.5\%$ . It is as well linear between  $-40^{\circ}\text{C}$  and  $+85^{\circ}\text{C}$ . The Spectron 300 acquires solar radiation. This self-powered sensor presents a range from 0 to  $1500\text{W}\cdot\text{m}^{-2}$ , a current output and a voltage output very practical. Finally, wind speed is estimated with our own anemometer. The energetic sensors are not described in detail because of the number.

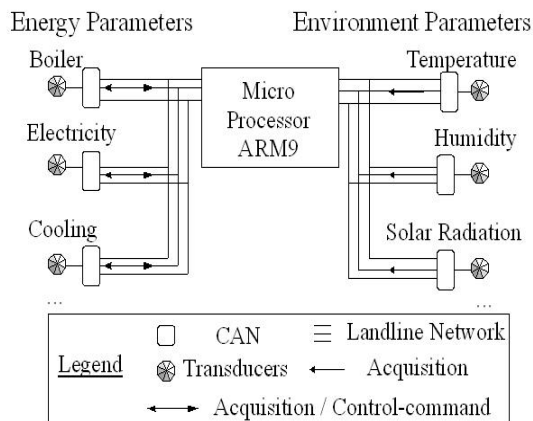

Figure 5. BEMS communication scheme.

Such architecture was developed and implemented at two different locations (Pyrescom headquarter and in a building mock-up).

### Monitoring station implementation

The first implementation is realized at Pyrescom headquarter, near the city of Perpignan, in the south of the France (figure 6). This prototype is designed to store environmental data and only one energetic acquisition. The aim is to gauge the robustness of our electronics in a real building, to assess energy performance by calculating the global energy performance indicator, and to perform a real time monitoring of the different parameters (see the following section). In this case, energy management is not the objective.

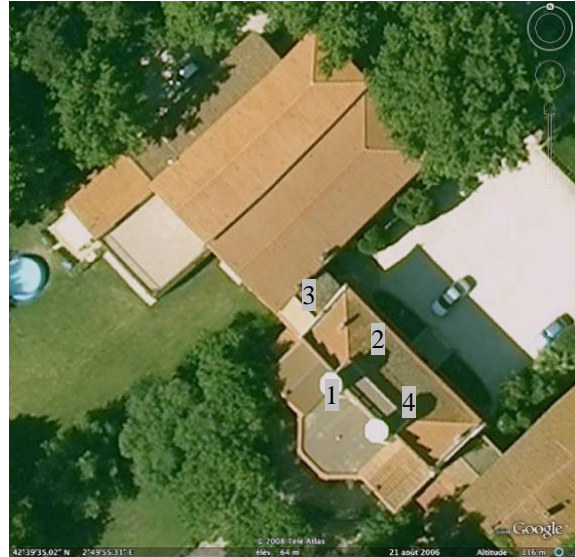

Figure 6. Pyrescom headquarter implementation.

The Pyrescom monitoring station is composed of (numbers are locations, see figure 6):

- Outdoor temperature and humidity (1),
- Outdoor temperature and humidity (2),
- Indoor temperature and humidity (3),
- Current electric consumption of the air conditioning system (4).

The second implementation is realized thanks to a building mock-up (figure 7) situated at the University of Perpignan, with the aim of testing various heating controllers (Talbert et al., 2008). A building mock-up is used for several reasons. First, the opportunity to instrument a real building with a set of sensors to test some energy controls is rare. In addition, the flexibility in sensors and heat sources locations is a real advantage. Then, the lack of thermal inertia promotes the reactivity, and avoids energy waste: just a little of electricity is consumed to heat the mock-up. Finally, thanks to practical works, the ELIAUS laboratory tries to make the university students aware of real problems regarding the energy consumption in buildings.

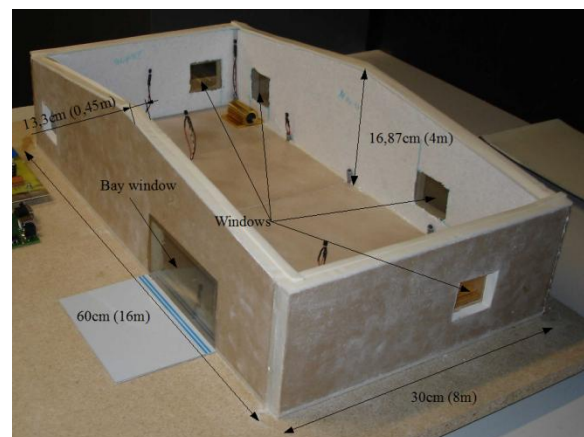

Figure 7. The building mock-up.

To design the mock-up, one must choose (i) the scale, (ii) the building materials, and (iii) the possibility to know easily the thermal losses of the construction. Instrumentation consists of eight temperature sensors (one outdoor and seven indoor sensors) and two heat sources represented by electrical resistors.

## BEMS APPLICATIONS AND RESULTS

This section is inspired by (Kummert et al., 2005), (Lygouras et al., 2007), (Yu et al., 2003), (Dounis et al., 2008), (Morel et al., 1999) and (Guillemin et al., 2001).

The first example of energy diagnosis is the real time monitoring of the electric current of the air-conditioning system in Pyrescom headquarter (figure 8). The data are collected every 30s, from 6 May 2008 to 10 July 2008.

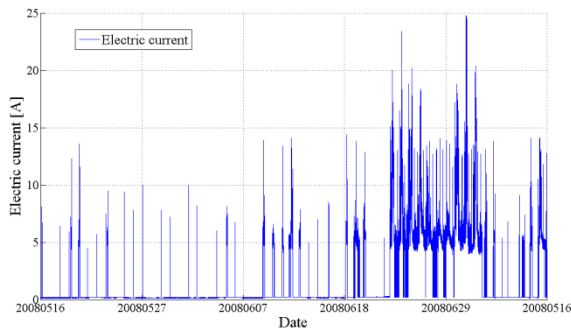

Figure 8. Electric current of the air-conditioning system.

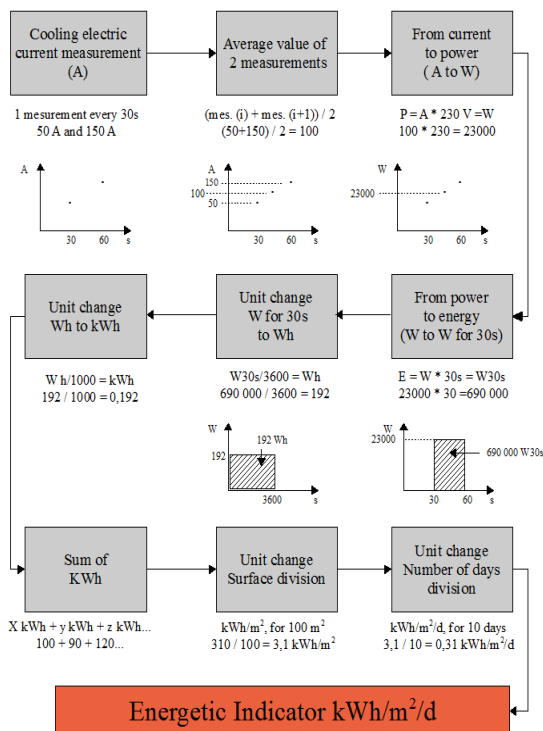

Figure 9. Air-conditioning consumption algorithm.

Calculating the global energy indicator is the next step of the audit. It is achieved using the algorithm depicted by figure 9.

The principle is to determine the energetic indicator in  $kWh.m^{-2}$  for an hour, a day, a month...from the measurement of the electric current (expressed in Ampere) of the air-conditioning system. The knowledge of the power applied at the air conditioning system and the frequency of the measurements allow the energy consumption estimation.

Then, after on-line monitoring the electric current, several energy consumptions allow completing the energy diagnosis. Figure 10 and figure 11 focus on energy consumption of the air-conditioning system.

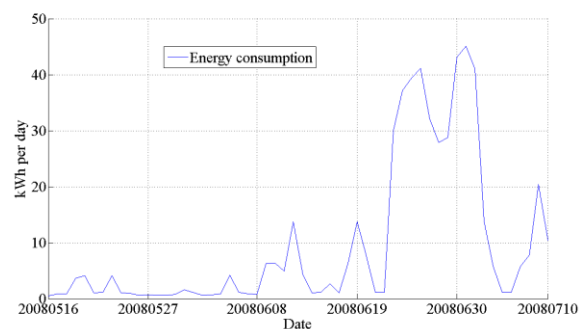

Figure 10. Daily energy consumption of the air-conditioning system.

For example, this energy performance assessment is useful to develop a fault detection analysis, to compare different energetic equipment or to estimate the power peak in order to restrict it.

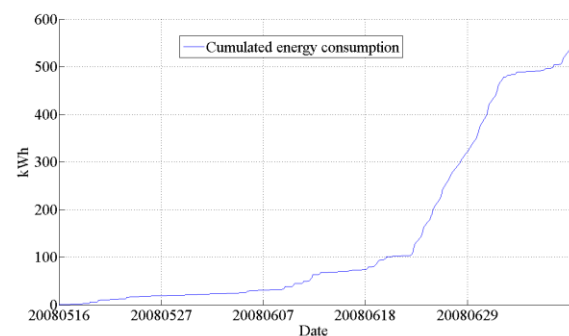

Figure 11. Cumulated energy consumption of the air conditioning system.

Performing cumulated energy consumption allows after month of monitoring:

- Directly obtaining the global energy performance indicator for a specific period (for many months, for a year, ...),
- Comparing different buildings.

This energetic on-line monitoring is useful to enhance the assessment of energy performance of buildings and to study the functioning of energy equipment in different conditions. However, this

energy audit, resorting to only one energetic parameter, can be considered as incomplete. On the other hand, its reproducibility is a strong point. It is usable whatever both the building and energy resources. We can easily imagine a complete energy audit, based on TRNSYS<sup>®</sup> simulation results, thanks to this monitoring station, for example including a specific electricity energy consumption or fuel energy consumption, always expressed with the afore-mentioned global energy performance indicator.

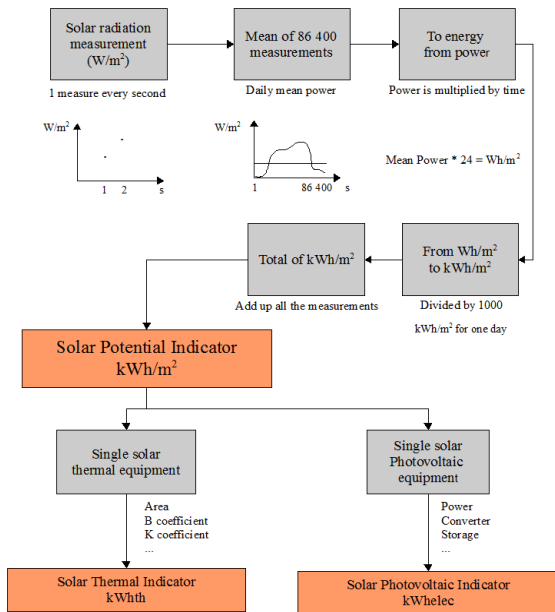

Figure 12. Solar potential estimation.

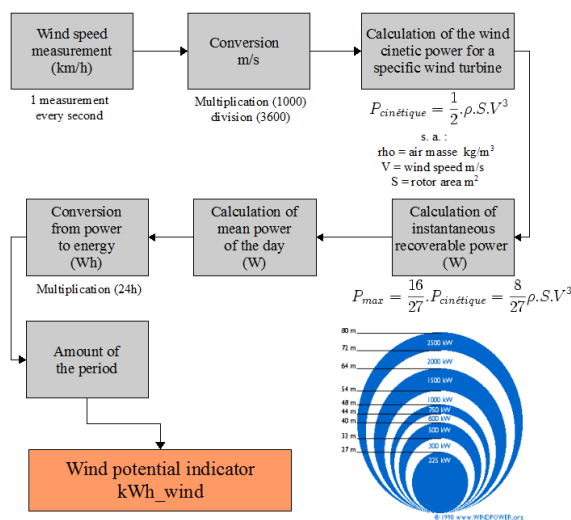

Figure 13. Wind potential estimation.

Knowing the energy performance in buildings is essential to reduce energy consumption, but it is not sufficient. To be efficient, the use of renewable energy must be improved. To this end, wattmeter and anemometer are tested using the monitoring station, in order to provide an estimation of the renewable

energy potential of a location. The objective is providing an audit, noticeably identical to figure 3 (TRNSYS<sup>®</sup> simulations results).

The required algorithms to assess potentialities of a location are described in figures 12 and 13, for solar and wind energy respectively.

### Building mock-up application

Our monitoring station would not be a complete BEMS without possibilities of energy management and control. Because heating is about 70 % of the total energy consumption in residential buildings in France, we have developed and tested several heating control schemes:

- The Proportional-Integral-Derivate (PID),
- The Model-based Predictive Control (MPC),
- The Fuzzy Logic Control (FLC).

However, testing the controllers in real houses causes inconveniency. The solution was so to design a building mock-up, which offers the possibility to work on energy management avoiding inconveniency and energy waste. Hence, the defined control strategies are tested thanks to MATLAB<sup>®</sup> simulations, using:

- Outdoor temperatures as perturbations,
- The building mock-up model,
- Temperature instructions from the legal documentation.

Firstly, the outdoor temperatures are measured at the University offices. Secondly, to develop the building mock-up model used in simulation, a temperature and a heat power data set is needed and acquired using the monitoring station. Several trainings to heat the mock-up were carried out, with different both resistor powers and periods of time. Thirdly, the definition of the temperature instructions is explained in the “Réglementation Thermique 2005”.

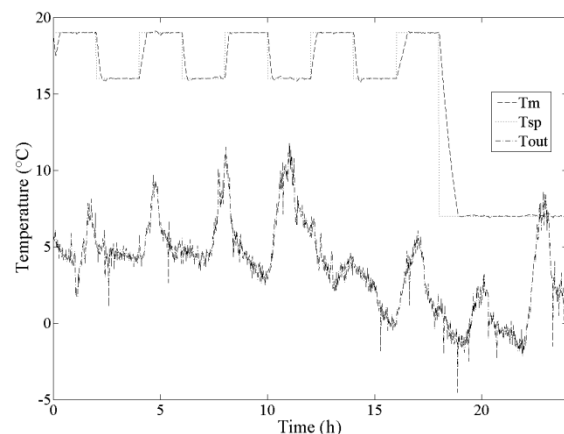

Figure 14. Heating control with MPC scheme.

The main goal of the heating control is to reduce fossil energy consumption while promoting the use of renewable energy. The different control strategies

are compared thanks to three criteria (the fossil energy part, a comfort criterion and a global performance criterion). To sum up, the MPC scheme provided the best results while the FLC scheme, mainly thanks to its flexibility, proved to be an interesting compromise between the easy to develop but not very efficient PID scheme and the efficient but hard to develop MPC scheme. More information can be found concerning heating control simulations in (Paris et al., 2008), (Paris et al., 2008) and (Eynard et al., 2009).

As an example, figure 14 depicts the obtained MPC results, where  $T_m$  is the mean temperature of the model,  $T_{sp}$  is the temperature set point and  $T_{out}$  is an outdoor perturbation.

## CONCLUSION

Because the building sector is one of the largest sectors of energy consumption, the work presented in this paper focuses on developing, with the support of industrial partners, a commercial monitoring station (BEMS) that acquires environmental and energetic data with the aim of performing an energy diagnosis based on a preliminary study, carried out using TRNSYS<sup>®</sup> simulations results. The main objective of this monitoring tool is to assess energy performance of buildings. The stored data are used (i) to plot in real time environmental parameters and (ii) to express the global energy indicator. This indicator, obtained thanks to algorithms, defines both energy consumptions and renewable energy potentials of a location.

Moreover, our BEMS can manage energy efficiently and contribute to indoor comfort, using various heating control schemes. The controllers used have been tested with MATLAB<sup>®</sup> simulations. Future work will include the evaluation of the developed control strategies in real buildings and the achievement with TRNSYS<sup>®</sup> simulations of a more complete energy diagnosis (heating, cooling, lighting...).

## ACKNOWLEDGEMENT

The authors acknowledge the FCE (Fonds de Compétitivité des Entreprises) for its financial support. We want also to thank our industrial partners: Pyrescom SA, Apex-BP Solar and the CSTB.

## REFERENCES

ADEME 2007 (Agence Départementale de l'Environnement et de la Maîtrise de l'Énergie). Les chiffres clés du bâtiment en 2006, Publications de l'ADEME.

Dounis, A.I., Caraiscos, C. 2008. Advanced control systems engineering for energy and comfort management in a building environment-A review, Renewable and Sustainable Energy Reviews.

Eynard, J., Paris, B., Grieu, S., François, G. 2009. Stratégies de contrôle pour la gestion énergétique d'un bâtiment, 3<sup>èmes</sup> Journées doctorales et Journées Nationales Modélisation Analyse et Conduite des Systèmes Dynamiques, Anger, France.

Guillemin, A., Morel, N. 2001. An innovative lighting controller integrated in a self-adaptive building control system, Energy and Buildings.

Journal Officiel. Décret n°2006-592 du 24 mai 2006 relatifs aux caractéristiques thermiques et à la performance énergétique des constructions, République française.

Journal Officiel, Décret n°2006-1147 du 14 septembre 2006 relatif au diagnostic de performance énergétique et à l'état de l'installation intérieure, République française.

Kummert, M., André, P. 2005. Simulation of a model-based optimal controller for heating systems under realistic hypotheses, Ninth International IBPSA Conference, Montréal, Canada.

Levermore, G. J. 2007. Building Energy Management Systems, Kindle Edition.

Levermore, G. J. 1993. Building Energy Management Systems: An application to heating and control, E and FN Spon.

Lygouras, J.N., Botsaris, P.N., Vourvoulakis, J., Kodogiannis, V. 2007. Fuzzy logic controller implementation for a solar air-conditioning system, Applied Energy.

Morel, A., Bauer, M., El-Khoury, M. 1999. Neurobat, a predictive and adaptive heating control system using artificial neural networks, International Journal of Solar Energy.

Official Journal of the European communities, Directive 2002/91/EC of the European Parliament and the Council of the 16 December 2002 on the energy performance of buildings.

Paris, B., Talbert, T., Polit, M. 2008. Système de gestion énergétique multi-sources dédié aux bâtiments, 6<sup>ème</sup> Colloque Capteurs, Bourges, France.

Paris, B., Eynard, J., Thiéry, F., Traoré, A., Talbert, T., Grieu, S., 2008. Fuzzy-PID control for multisource energy management in buildings, International Conference on Renewable Energies and Eco-Design in Electrical Engineering, Montpellier, France.

Paris, B., Eynard, J., François, G., Talbert, T., Traoré, A., Thiéry, F. 2008. Gestion des ressources énergétique d'un bâtiment : contrôle flou, International IBPSA Conference, Lyon, France.

Paris, B., Eynard, J., Thiéry, F., Traoré, A., Polit, M., Talbert, T. 2008. Travaux pratiques sur la

gestion optimale d'un bâtiment Enr. 7ième Colloque sur l'Enseignement des Technologies et des Sciences de l'Information et des Systèmes, Université Libre de Brussel, Belgium.

Talbert, T., Paris, B., Eynard, J., Grieu, S., Fruchier, O. 2008. Lab-scale prototype for on-line monitoring and energy diagnosis in buildings, International Conference on Renewable Energies and Eco-Design in Electrical Engineering, Montpellier, France.

Yu, B., Van Passen,. D.H.C. 2003. Fuzzy neural networks model for buildings energy diagnosis, Eighth International IBPSA Conference, Eindhoven, Netherlands.