



HAL
open science

Simulating quantum transport with atoms and light

Philippe Bouyer

► **To cite this version:**

Philippe Bouyer. Simulating quantum transport with atoms and light. HYBRID QUANTUM SYSTEMS: NEW PERSPECTIVES ON QUANTUM STATE CONTROL, May 2010, Heidelberg, Germany. hal-00502398

HAL Id: hal-00502398

<https://hal.science/hal-00502398v1>

Submitted on 14 Jul 2010

HAL is a multi-disciplinary open access archive for the deposit and dissemination of scientific research documents, whether they are published or not. The documents may come from teaching and research institutions in France or abroad, or from public or private research centers.

L'archive ouverte pluridisciplinaire **HAL**, est destinée au dépôt et à la diffusion de documents scientifiques de niveau recherche, publiés ou non, émanant des établissements d'enseignement et de recherche français ou étrangers, des laboratoires publics ou privés.



Simulating quantum transport with atoms and light



P. BOUYER

Laboratoire Charles Fabry de l'Institut d'Optique
Palaiseau, France

Physics Department, Stanford University

Stanford, USA

«Quantum simulators» : building a controllable quantum system to simulate other quantum systems.

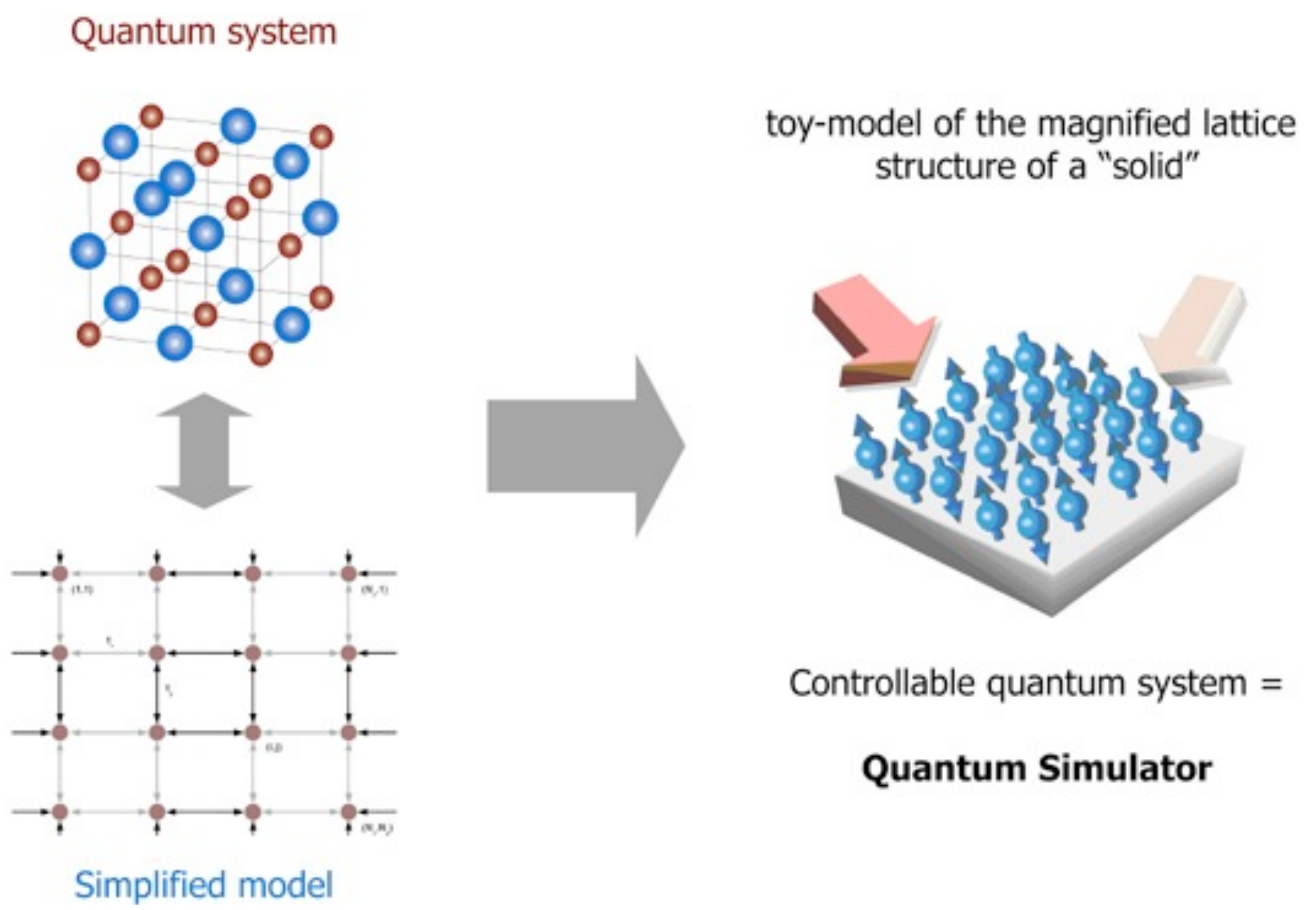

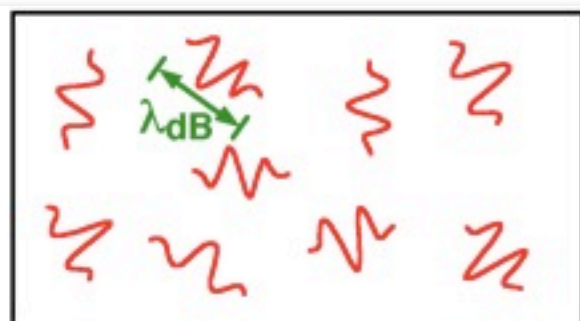

Low Temperature T:
De Broglie wavelength
 $\lambda_{dB} = h/mv \propto T^{-1/2}$
"Wave packets"
„Wave packets“
 $v_{DB} = h/m\lambda \propto T^{1/2}$

Atoms cooled below 1 μ K

Distribution of particles with velocities around mm/s

Distribution on matter waves with de Broglie wavelength $\approx 1 \mu$ m



Degenerate gases

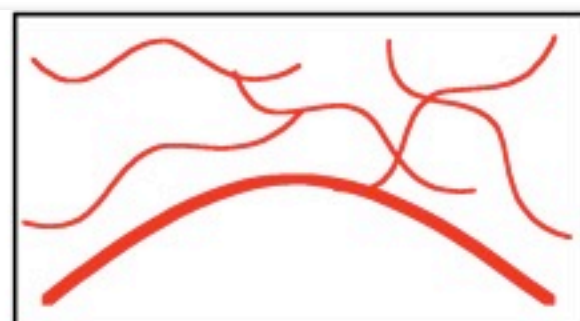

T = T_{crit}:
Bose-Einstein Condensation
 $\lambda_{dB} \approx d$
"Matter wave overlap"
„Matter wave overlap“
 $v_{DB} = d$

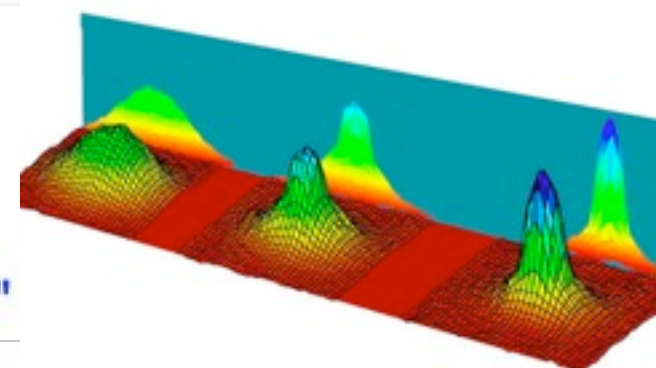

□ Non-dissipative potentials made with light

- No photon scattering (coherent)
- Dispersive (dephasing) part of radiative force

Optical traps

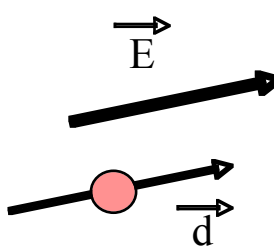
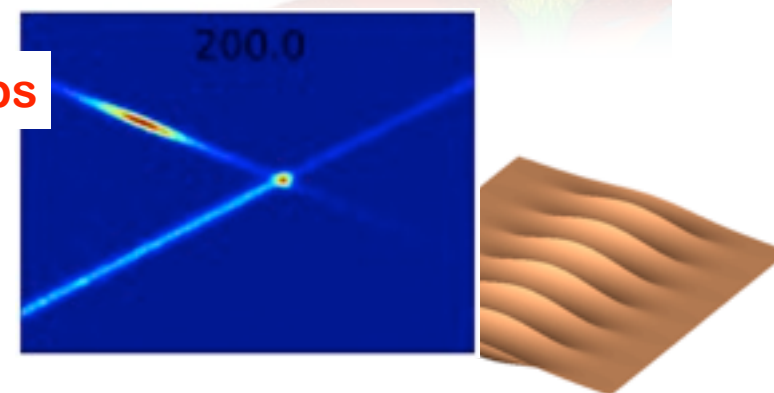

$$U = -\mathbf{d} \cdot \mathbf{E} = -\alpha(\omega)E^2$$

Superfluidity

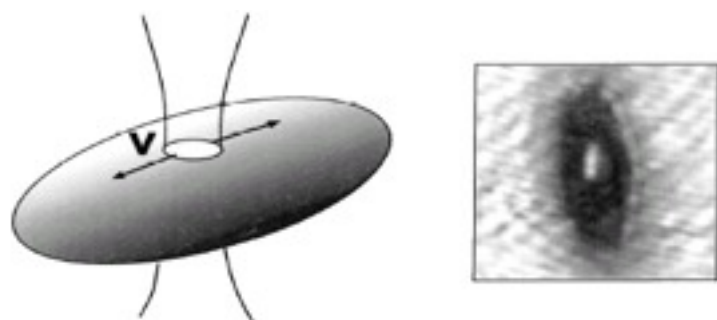

C. Raman et al., PRL. 83, 2502–2505 (1999).

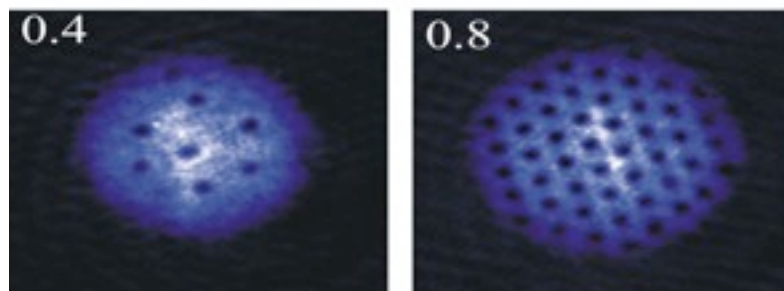

Degenerate mixtures
(bosons, fermions).

Controllable
configurations and
interactions

Mott transition

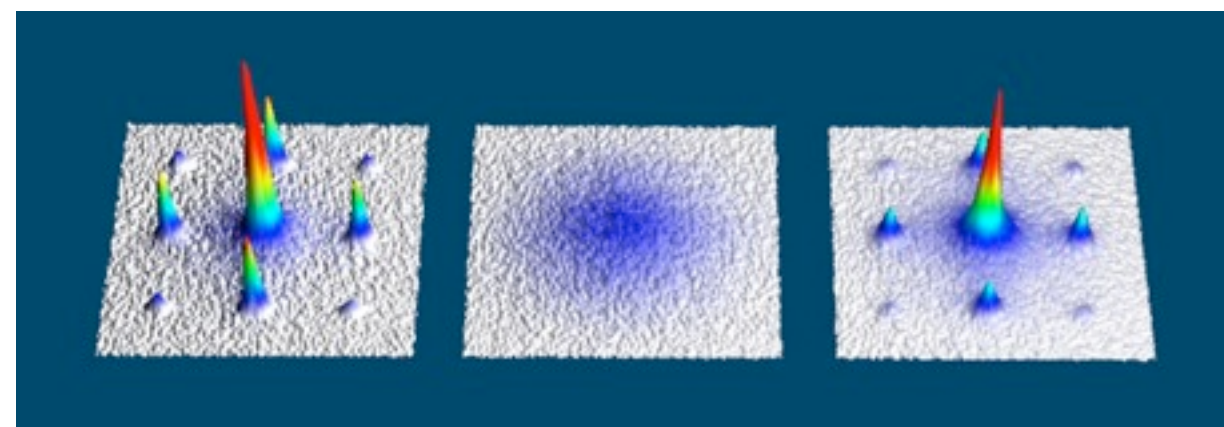

M. Greiner et al.,
Nature 415, 39–44, 2002

BEC–BCS crossover

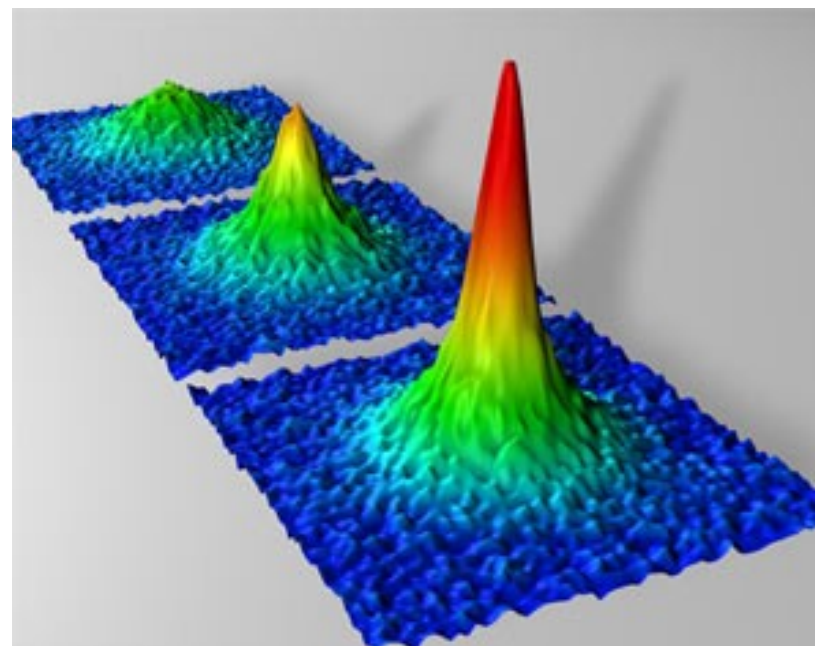

C.A. Regal & D.S. Jin.,
PRL 90, 230404, 2003

BKT transition

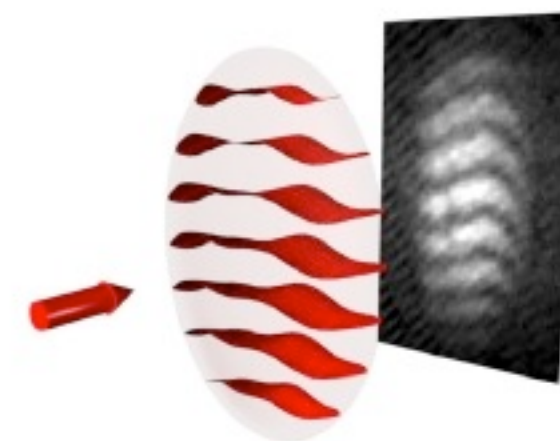

Z. Hadzibabic et al.,
Nature 441, 1118–1121 (2006)

One of the key topics in condensed matter physics is to study the response of electrons to an electromagnetic field

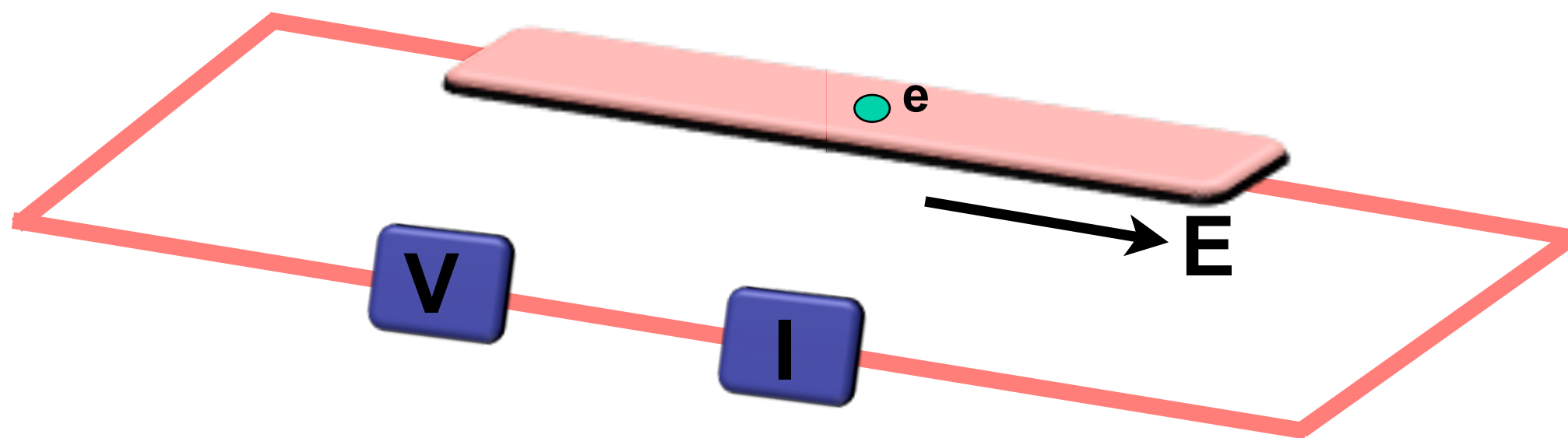

Can we simulate transport and conduction of electrons with atoms.
What is the role of disorder ...

In a perfectly ordered metal

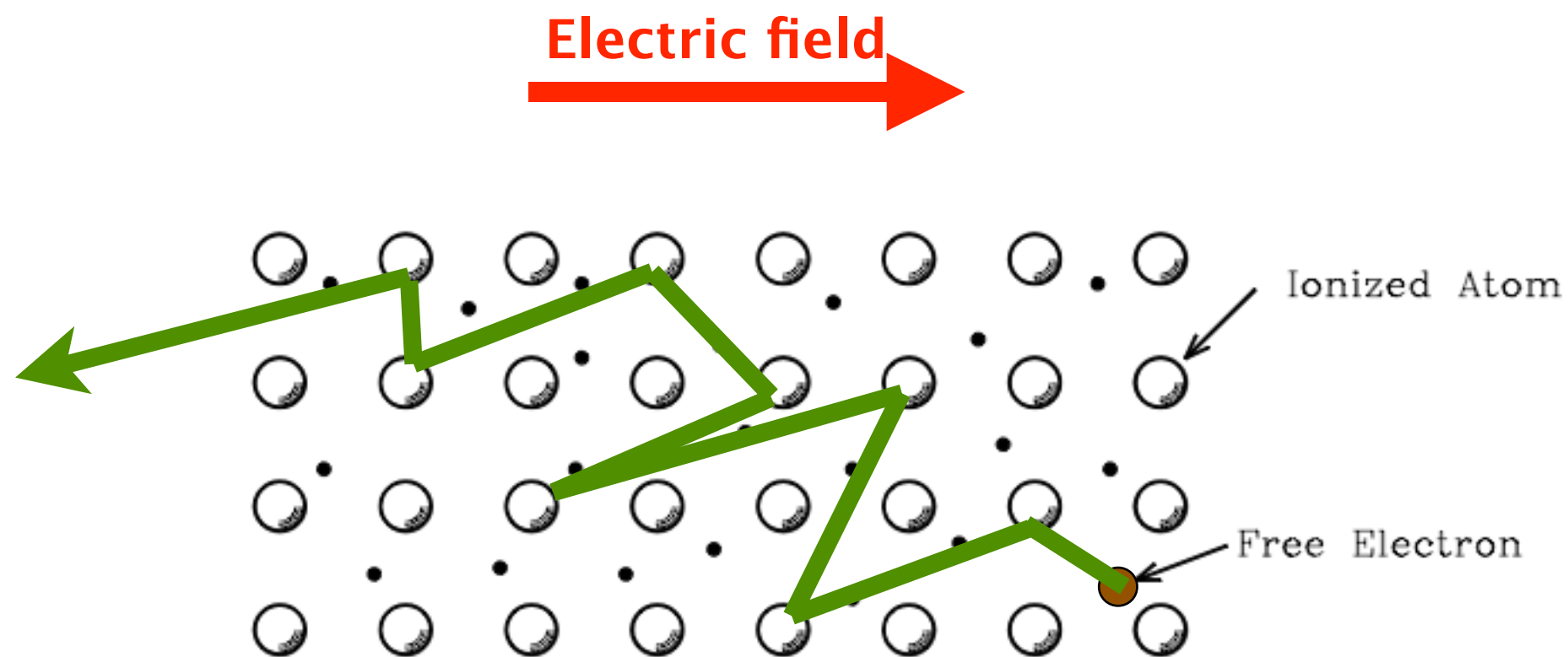

Diffusive transport caused by scattering on lattice defects (Drude model)

In a perfectly ordered metal

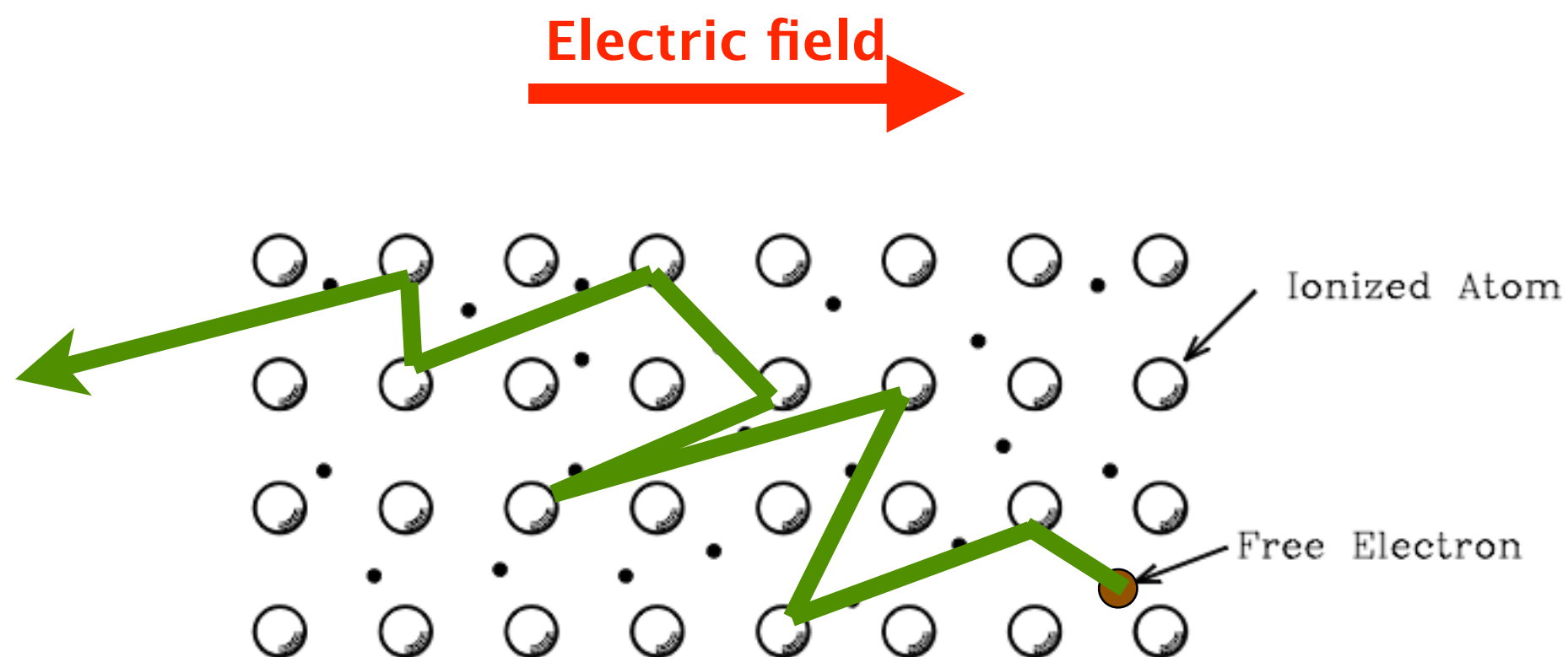

Diffusive transport caused by scattering on lattice defects (Drude model)

Thermal excitation increases diffusion = reduced conductivity

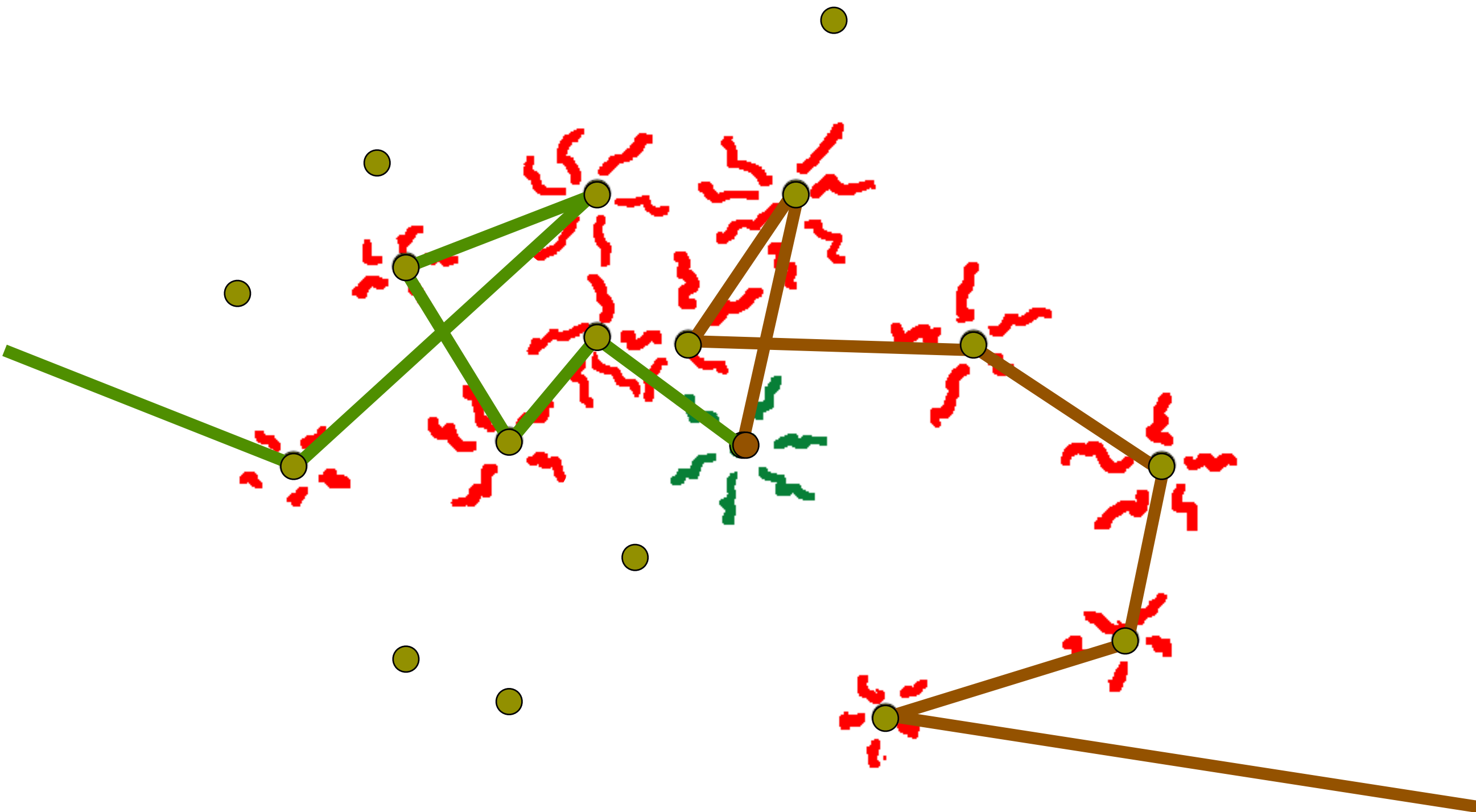

Waves but no coherence bouncing on impurities = diffusion

If the length scales become small compare to the de Broglie wavelength and/or the phase coherence length, then quantum mechanics will rule the transport properties.

The probability for a particle to go from point A to point B is the sum of the amplitudes of all possible trajectories.

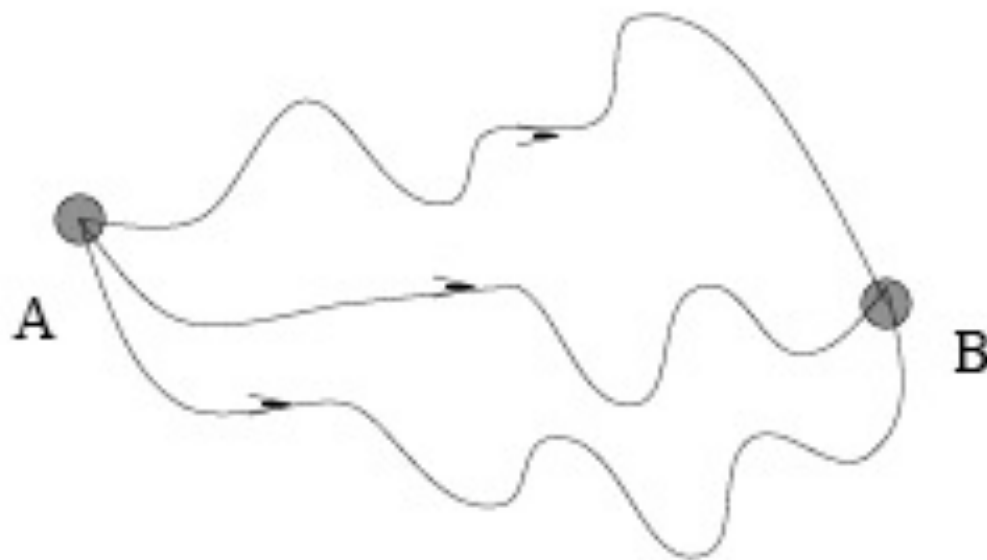

Interference terms can appear and the transport properties can be modified

Destructive interference

ANDERSON LOCALISATION

PHYSICAL REVIEW VOLUME 109, NUMBER 5 MARCH 1, 1958

Absence of Diffusion in Certain Random Lattices

P. W. ANDERSON
Bell Telephone Laboratories, Murray Hill, New Jersey
(Received October 10, 1957)

This paper presents a simple model for such processes as spin diffusion or conduction in the "impurity band." These processes involve transport in a lattice which is in some sense random, and in them diffusion is expected to take place via quantum jumps between localized sites. In this simple model the essential randomness is introduced by requiring the energy to vary randomly from site to site. It is shown that at low enough densities no diffusion at all can take place, and the criteria for transport to occur are given.

If mean free path smaller than de Broglie wavelength:
constructive interference of trajectories returning to
origin: **localized states**: insulator

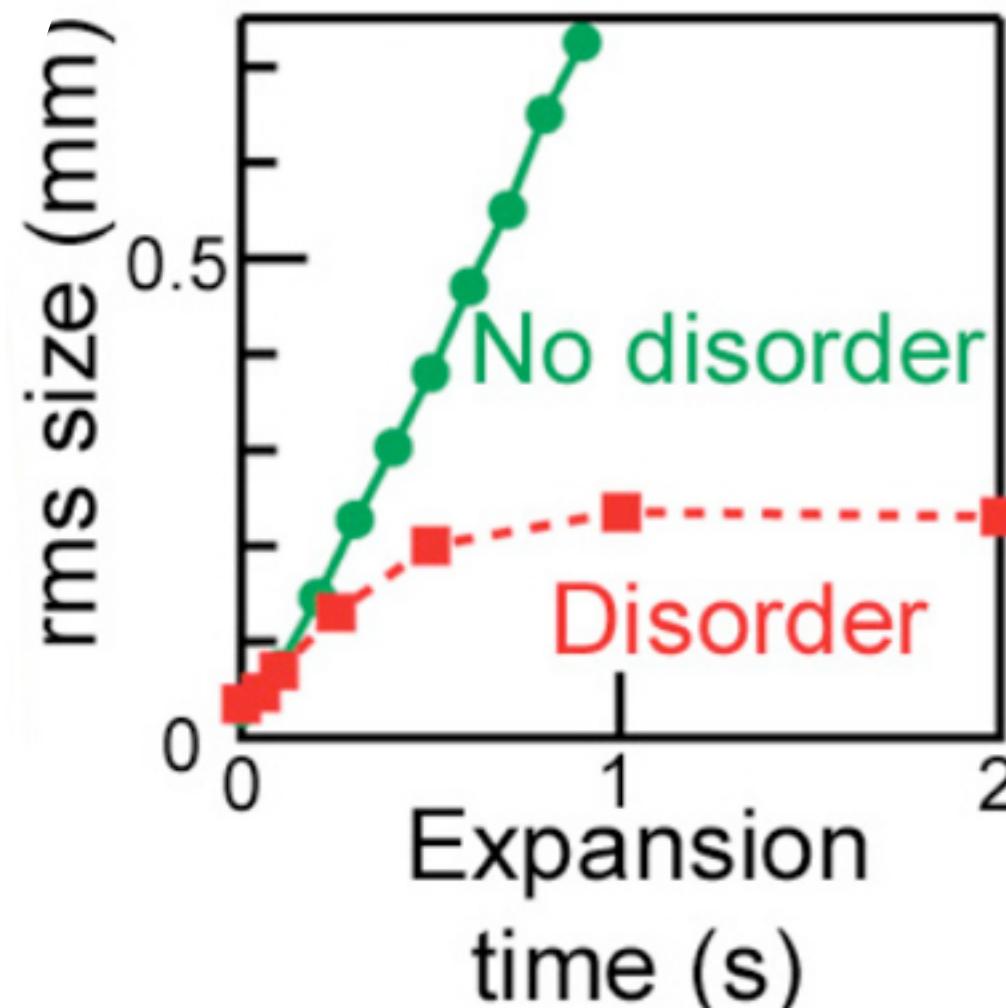
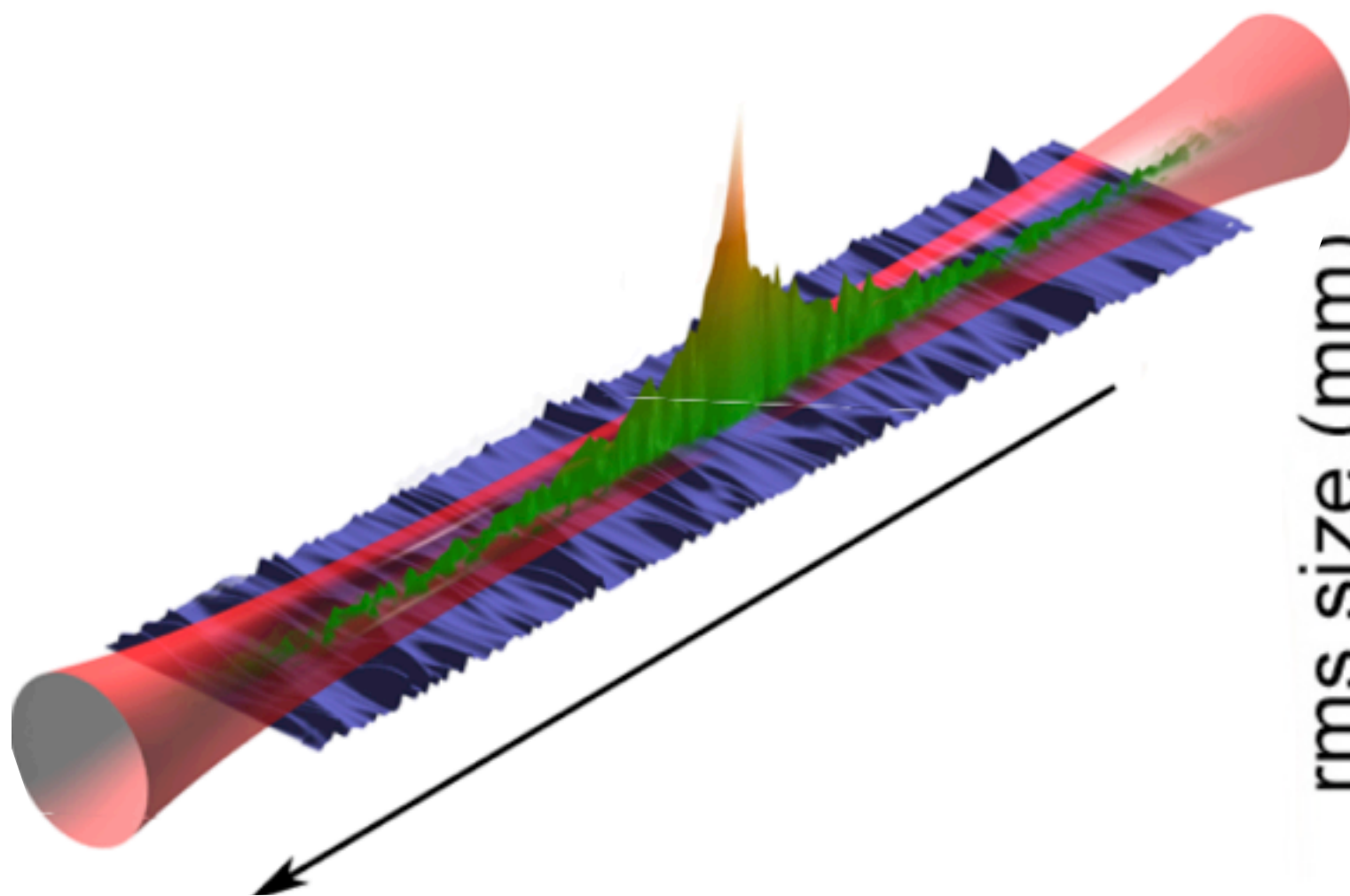

Billy, J. et al. *Nature* **453**, 891-894 (2008).

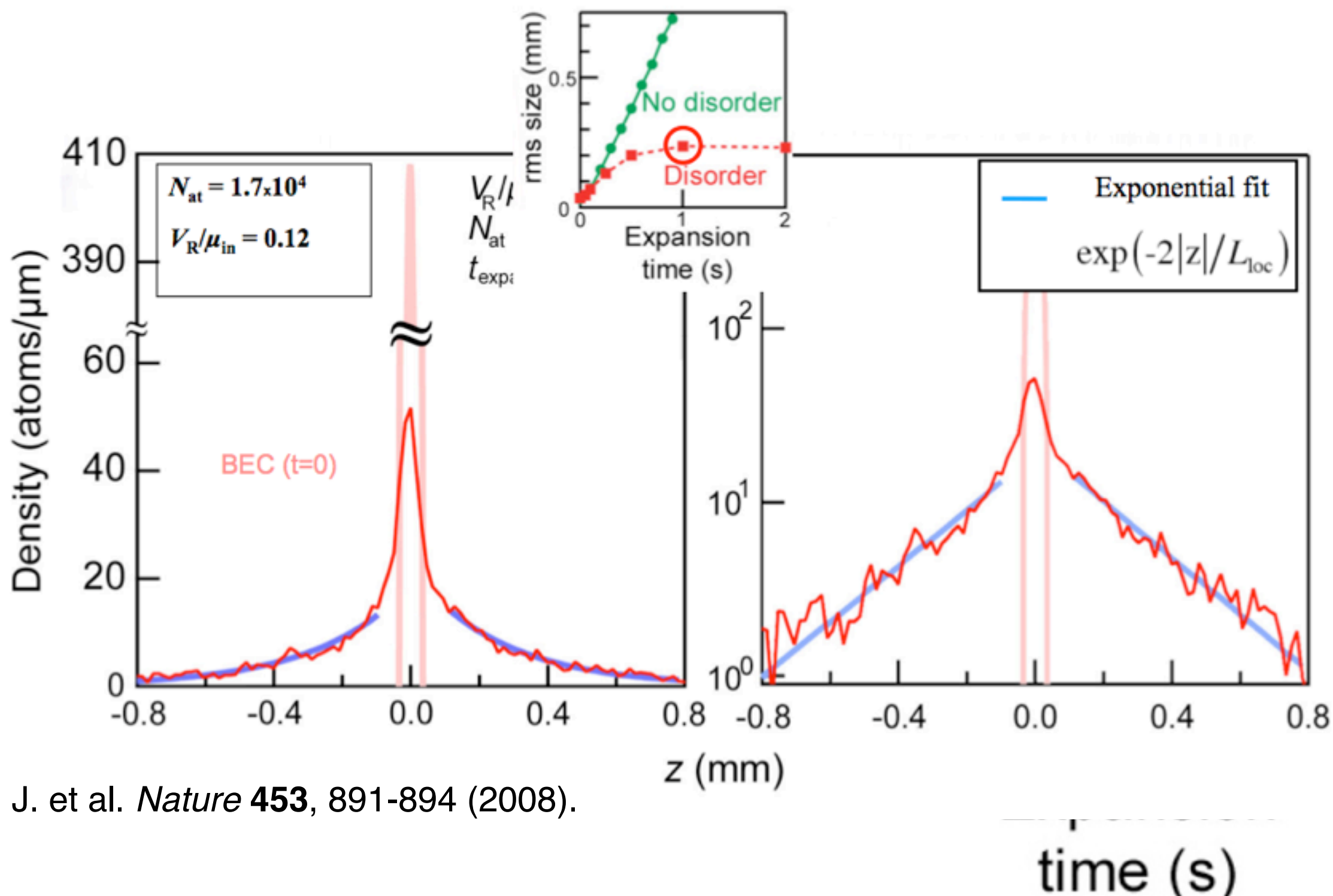

Billy, J. et al. *Nature* **453**, 891-894 (2008).

TRANSPORT IN 2 DIMENSION WITH MATTER WAVES AND DISORDER

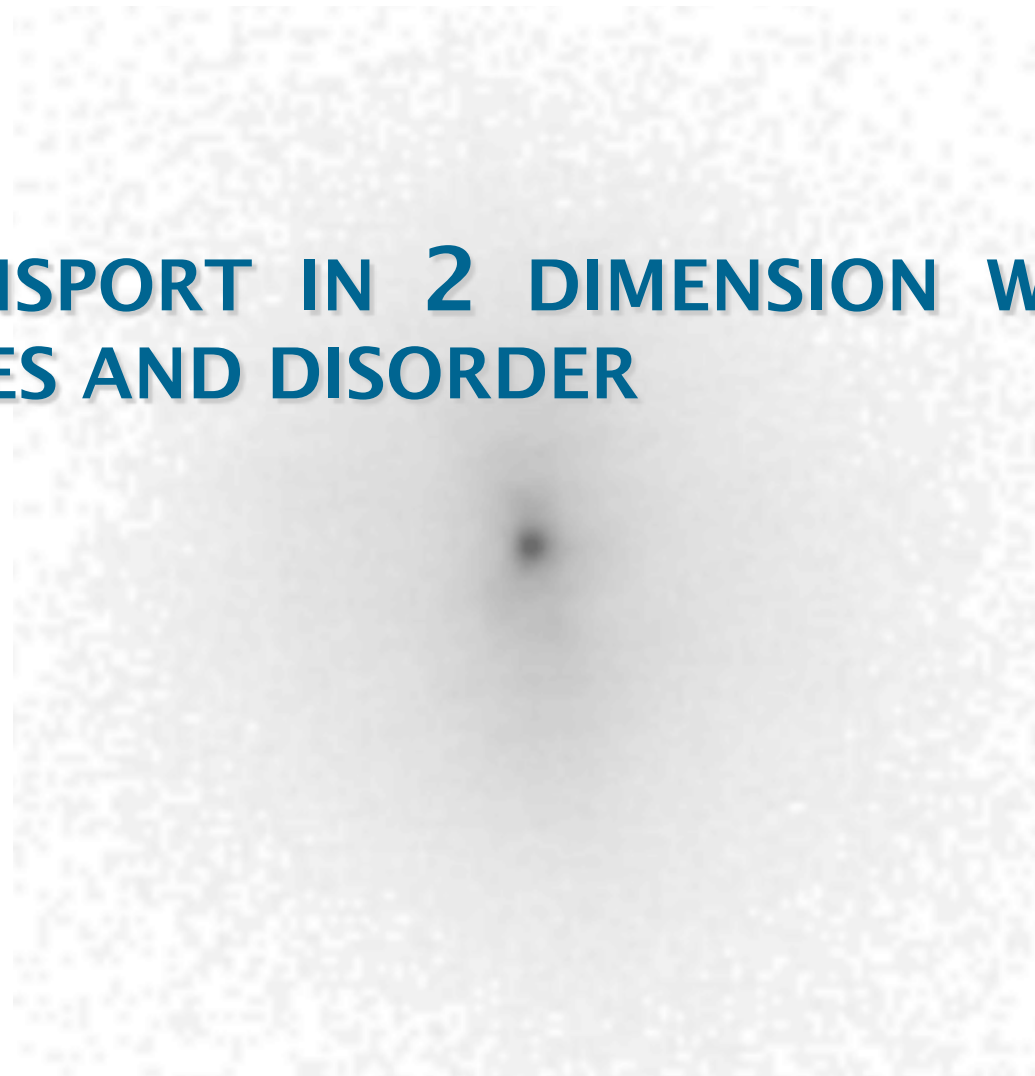

EXPANSION OF MATTER WAVE



Crossed dipole trap with 1 small beam

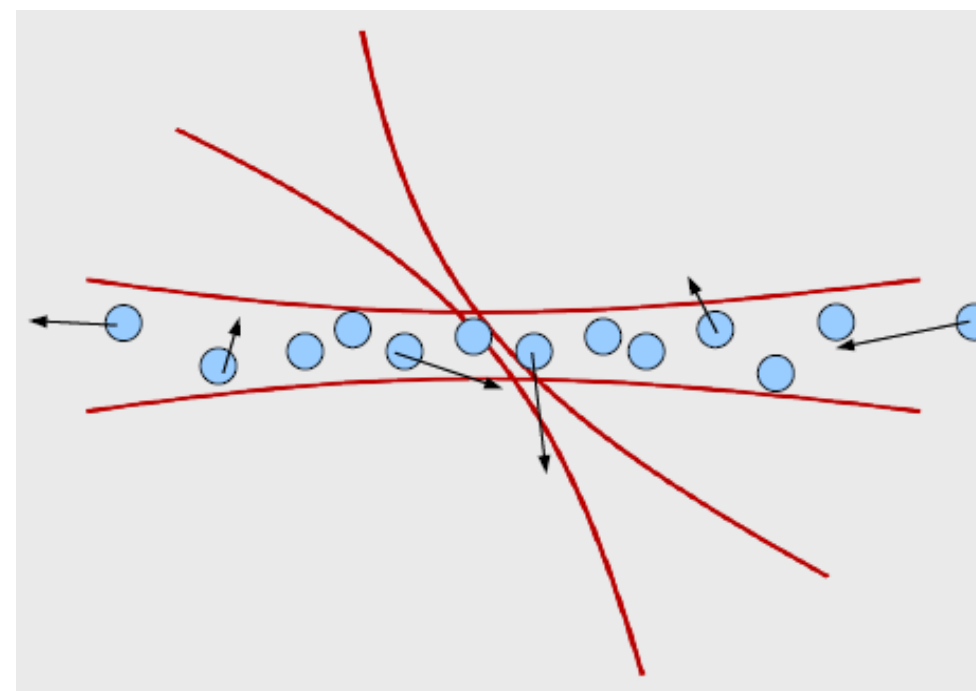
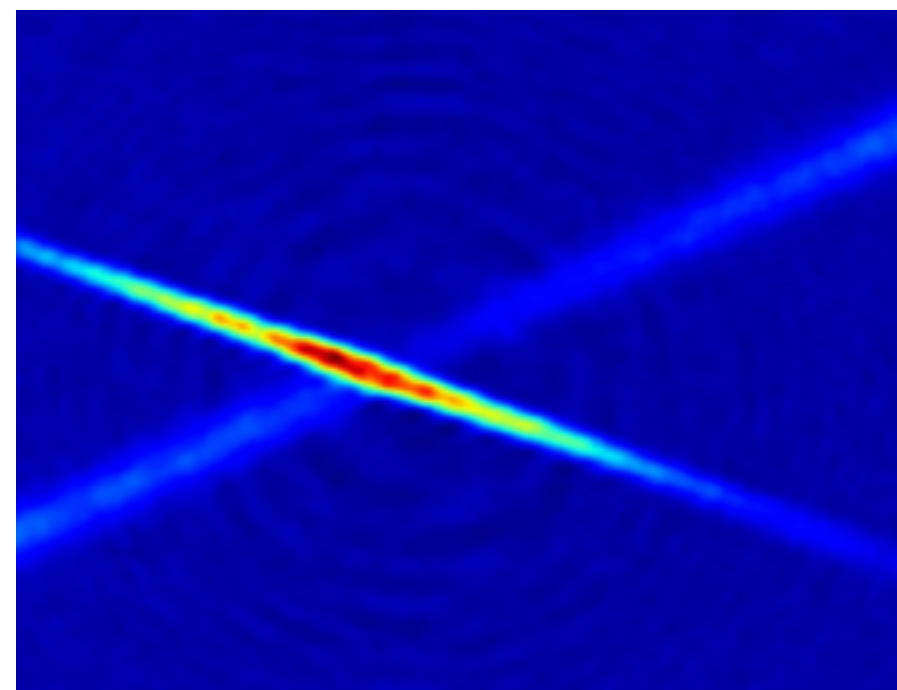
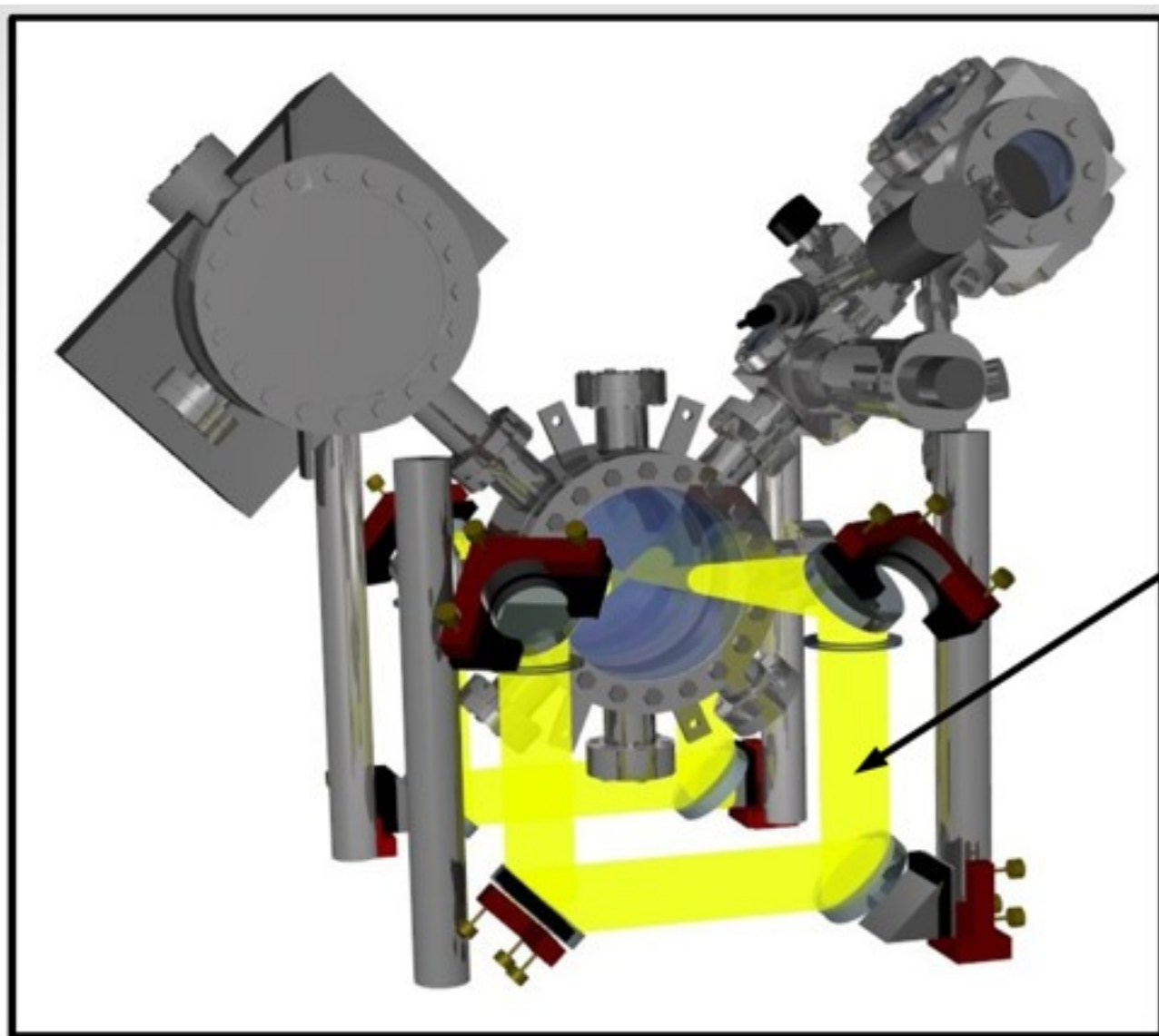

J.-F. Clément, *et al.*, Phys. Rev. A **79**, 061406(R) (2009).

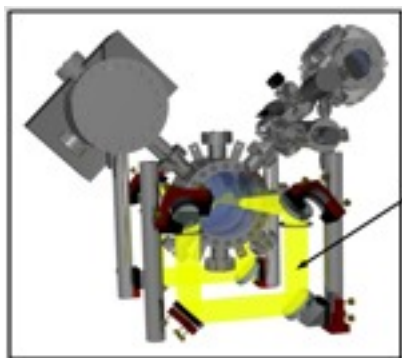
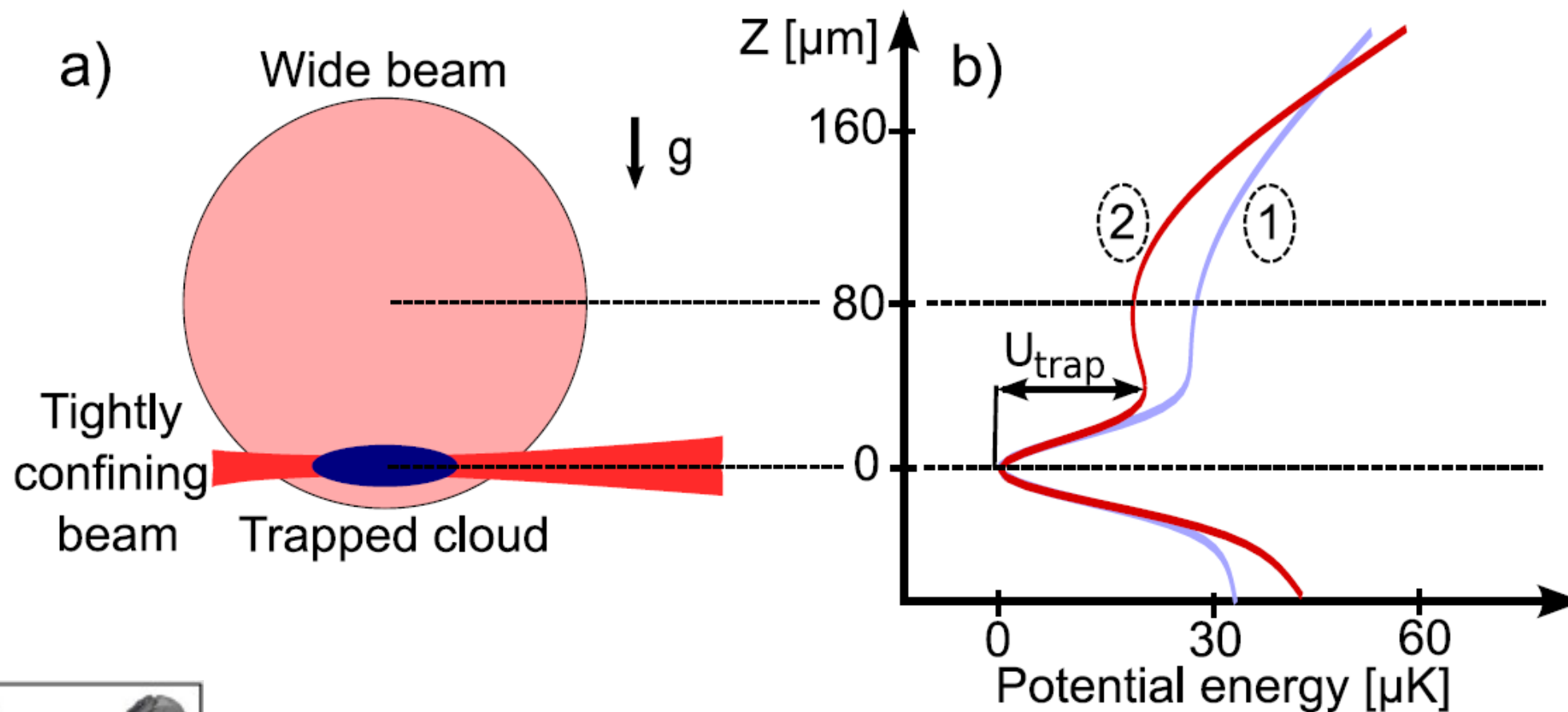

J.-F. Clément, *et al.*, Phys. Rev. A **79**, 061406(R) (2009).

Tc with 10^6 atoms
 Pure spinor condensates
few 10^5 atoms
 3 seconds of evaporation
BEC achieved in 650 ms

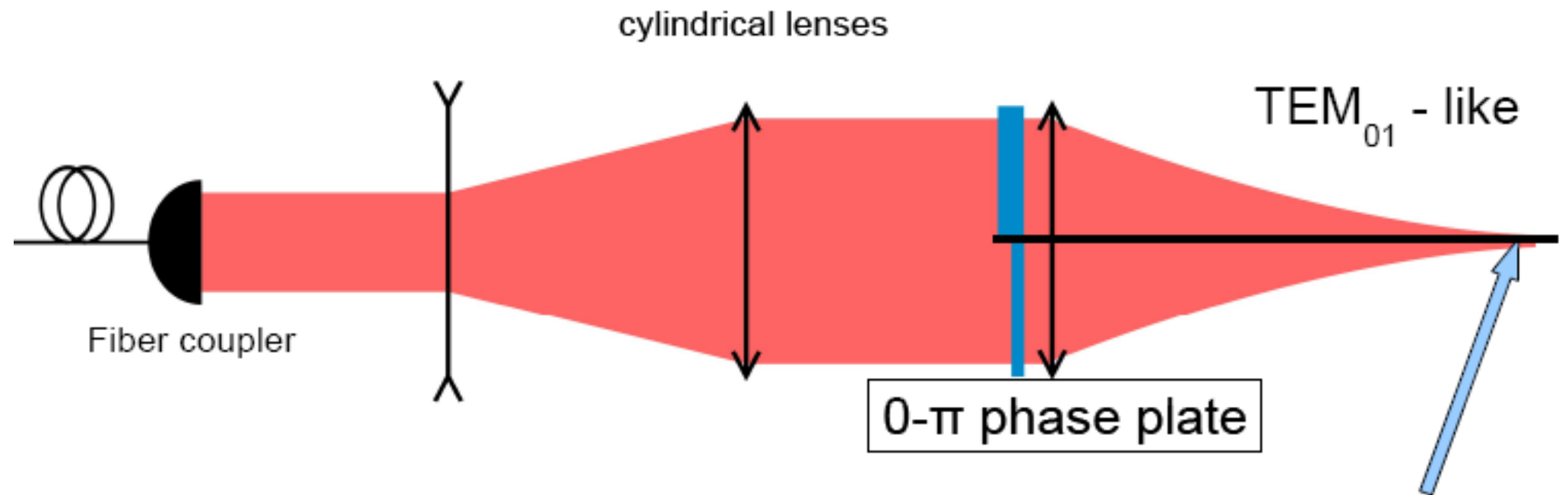

$\lambda=767\text{nm}$ **BLUE DETUNED**
 $P=150\text{mW}$
 $f_z = 600\text{ Hz}$

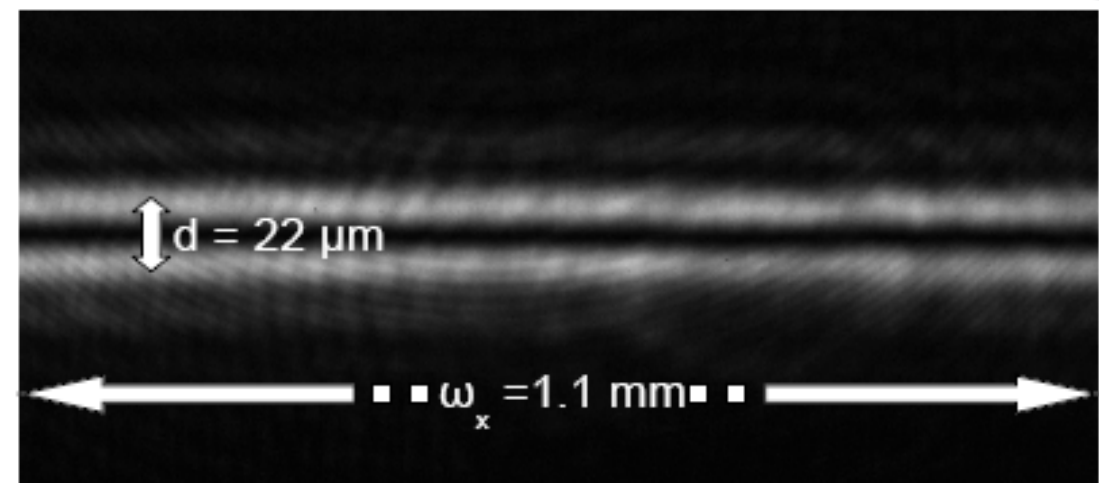
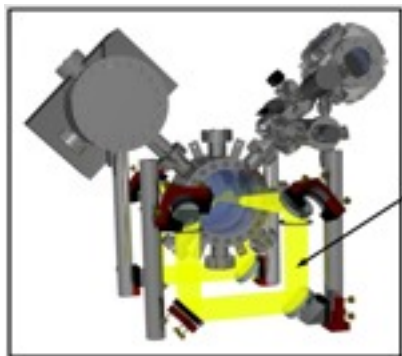

G. Stern et al., arXiv:1003.4761

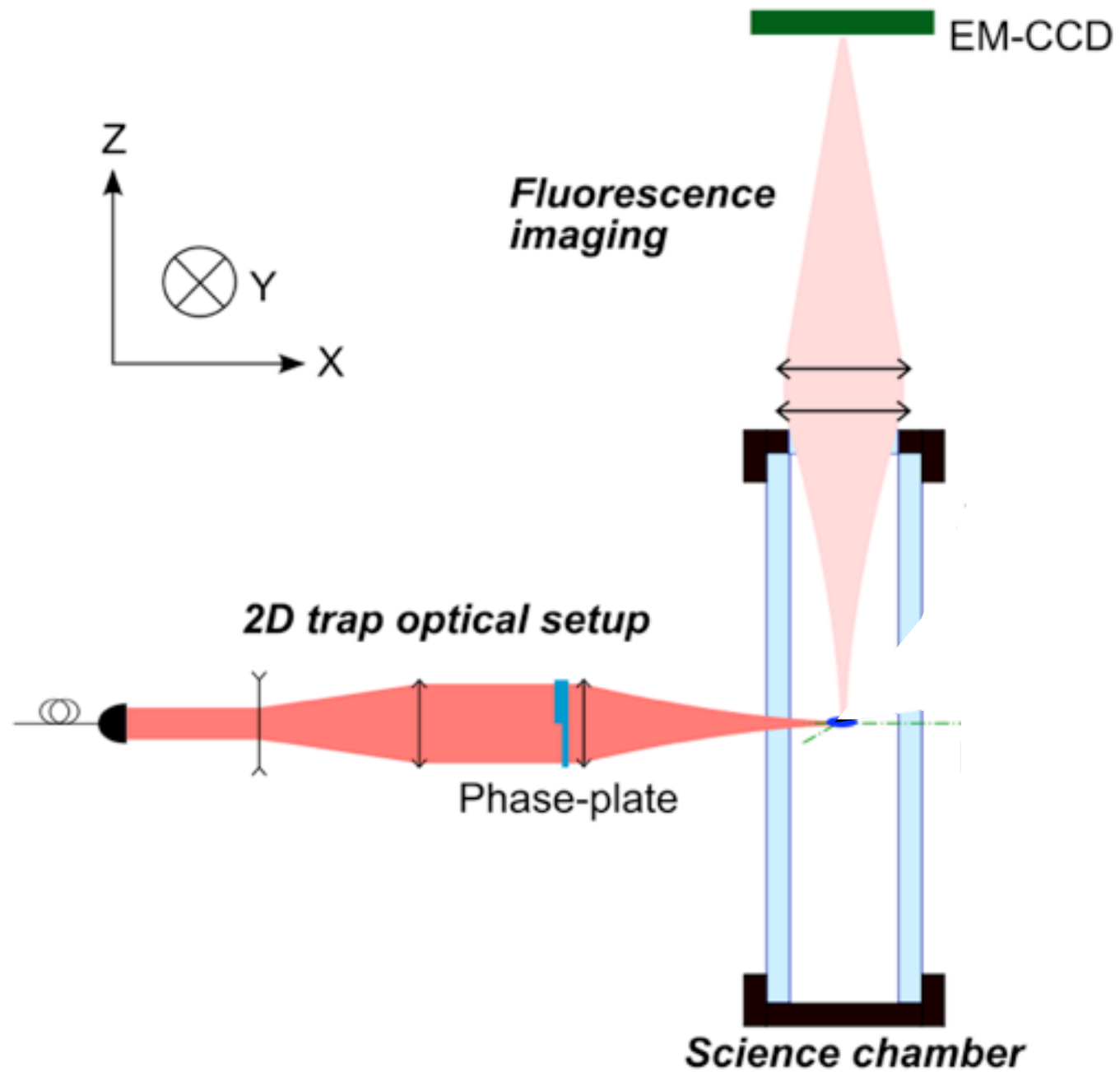

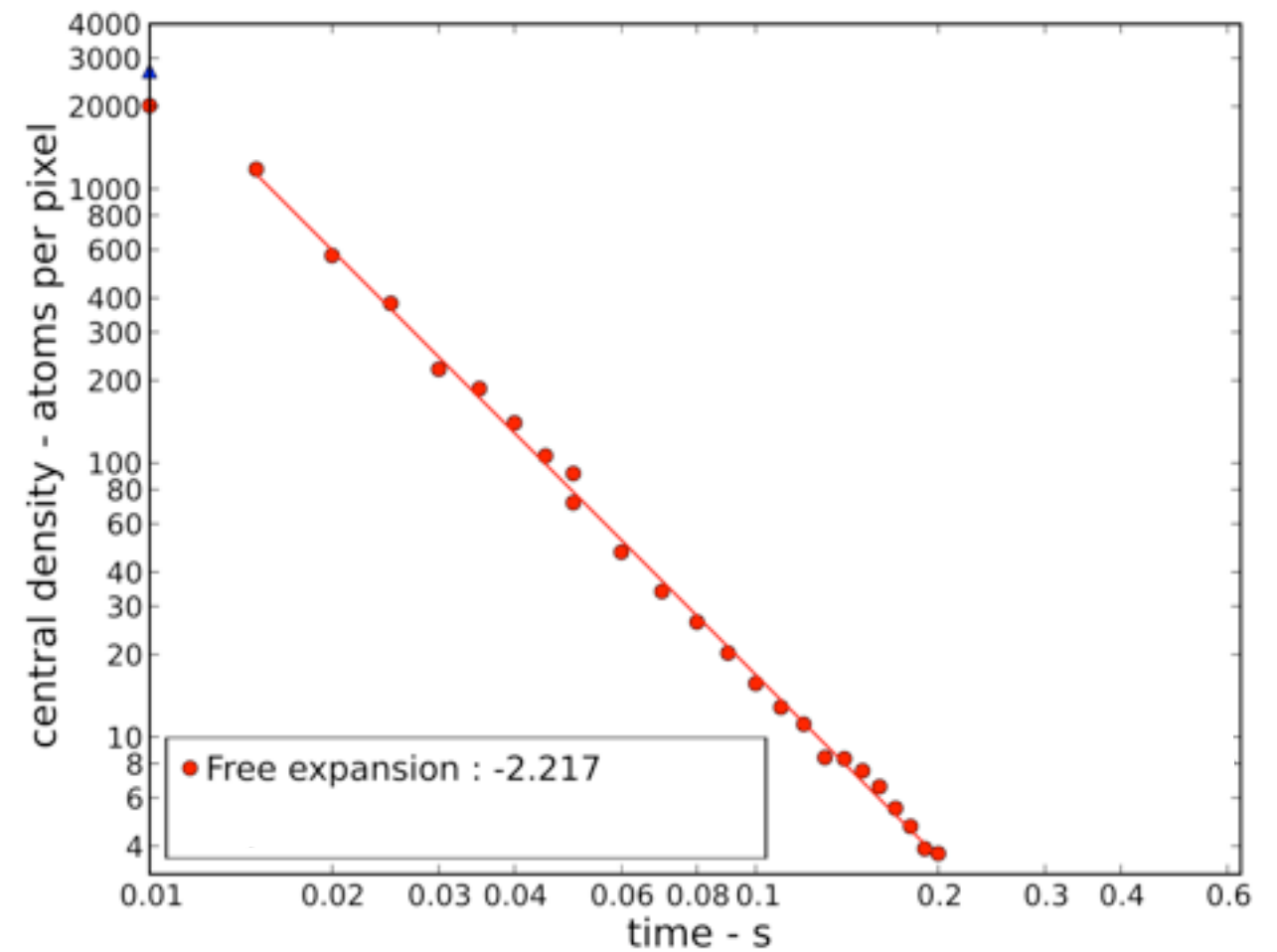
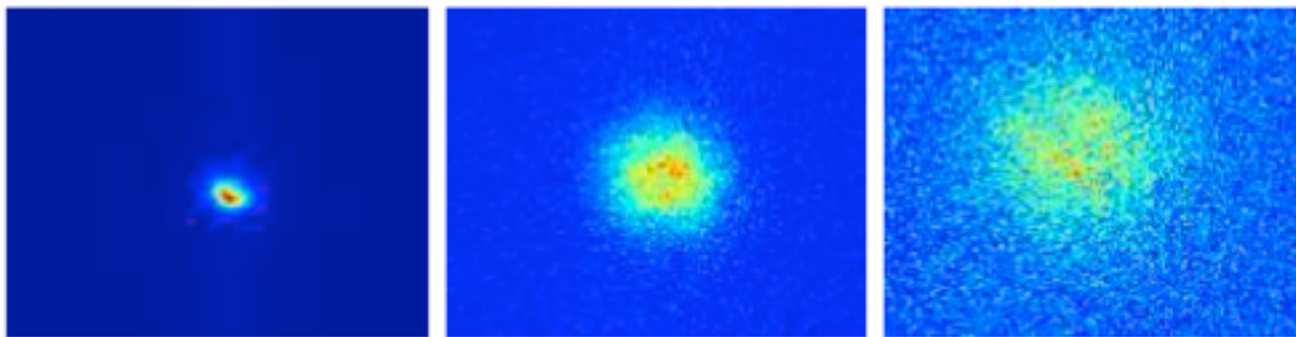

$$r^2(t) = r^2(0) + \frac{k_B T}{M} t^2$$

2D density scales as $1/r^2$



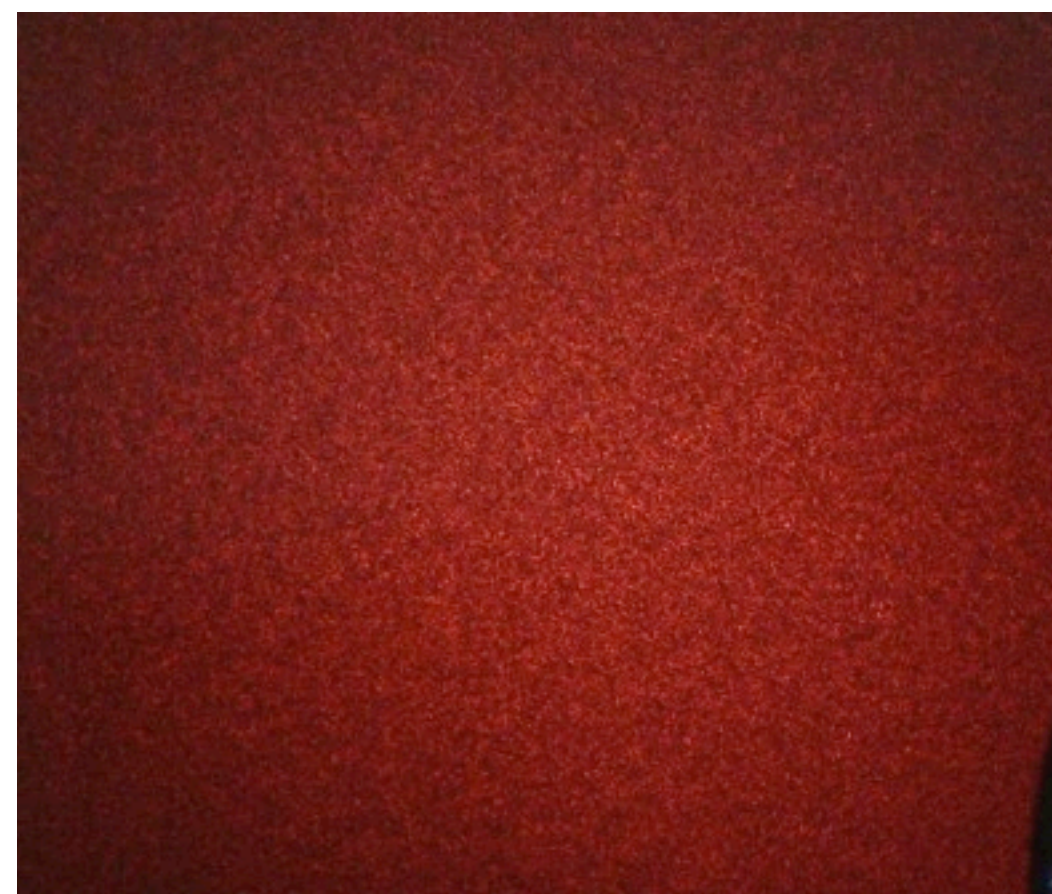
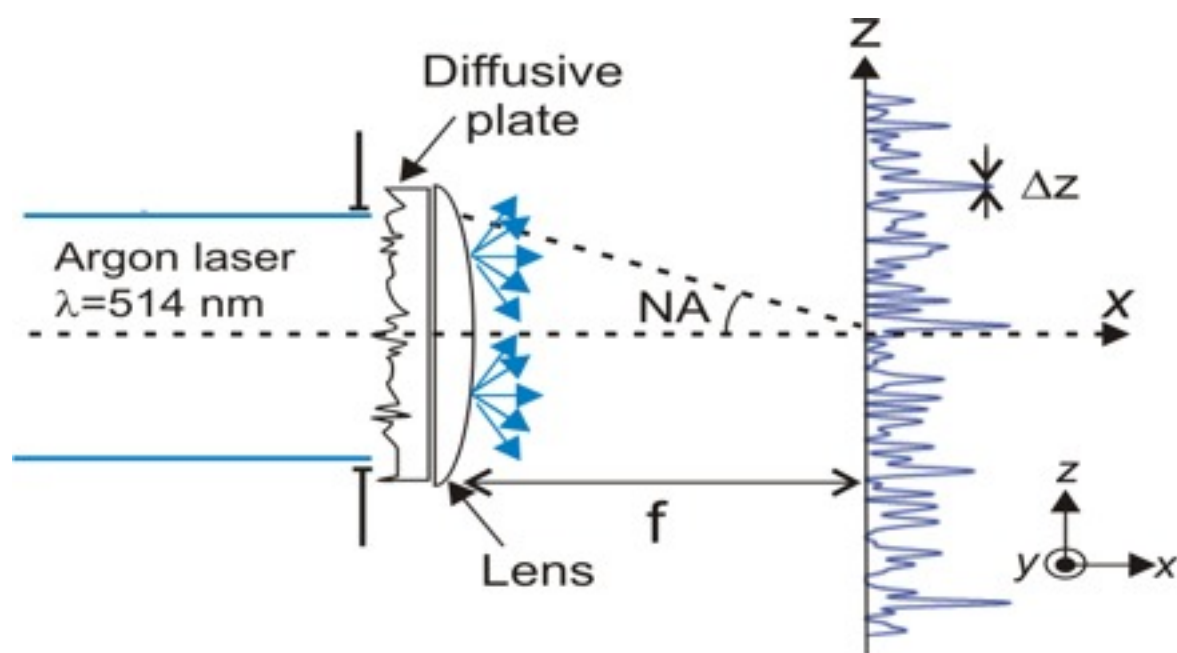

Depth of the optical wells

Indirect (CCD) and direct (using HF spectroscopy) measurements

Statistical properties verified $\sigma_I \sim \langle I \rangle$

Potential depth σ_V calculated from σ_I

$$\sigma_V = \frac{2 \Gamma^2 \sigma_I}{3 2 \delta I_S}$$

Good agreement with HF measurements (calibration)

Disorder amplitude definition γ : $\gamma = \sigma_V / \mu$

Spatial autocorrelation : $C(\delta z) = \langle V(z)V(z+\delta z) \rangle$

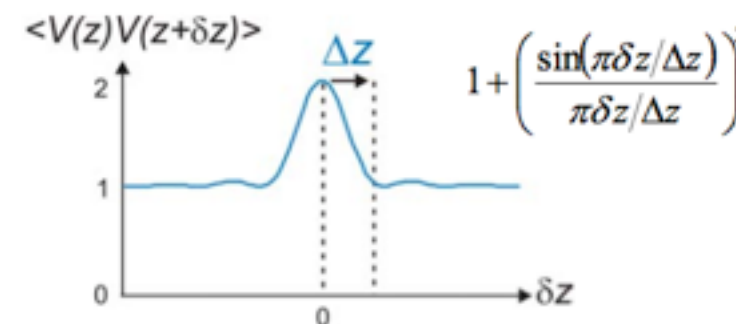

$$\Delta z = \frac{\lambda}{2(N.A.)} = 0.8 \mu m$$

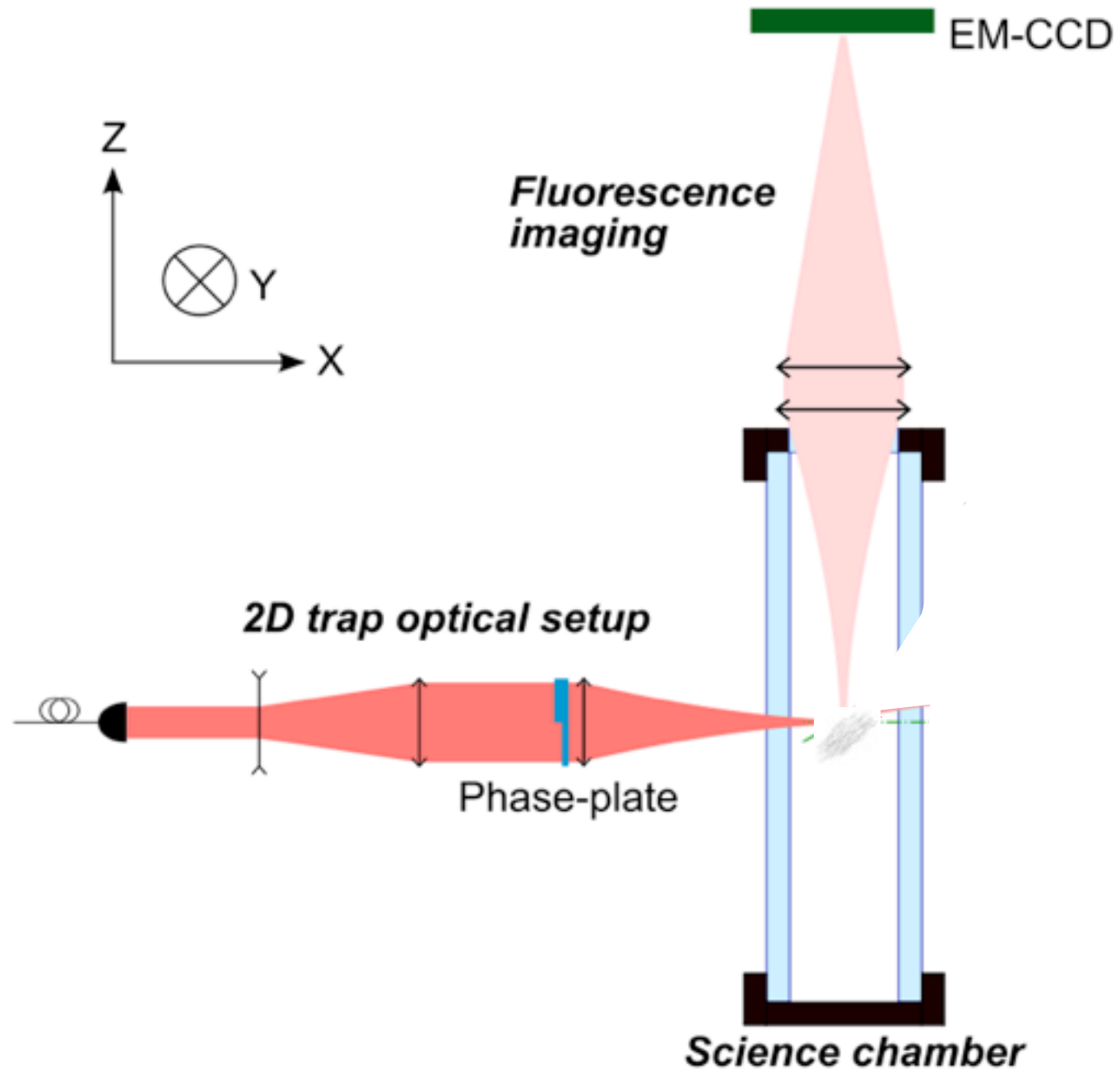

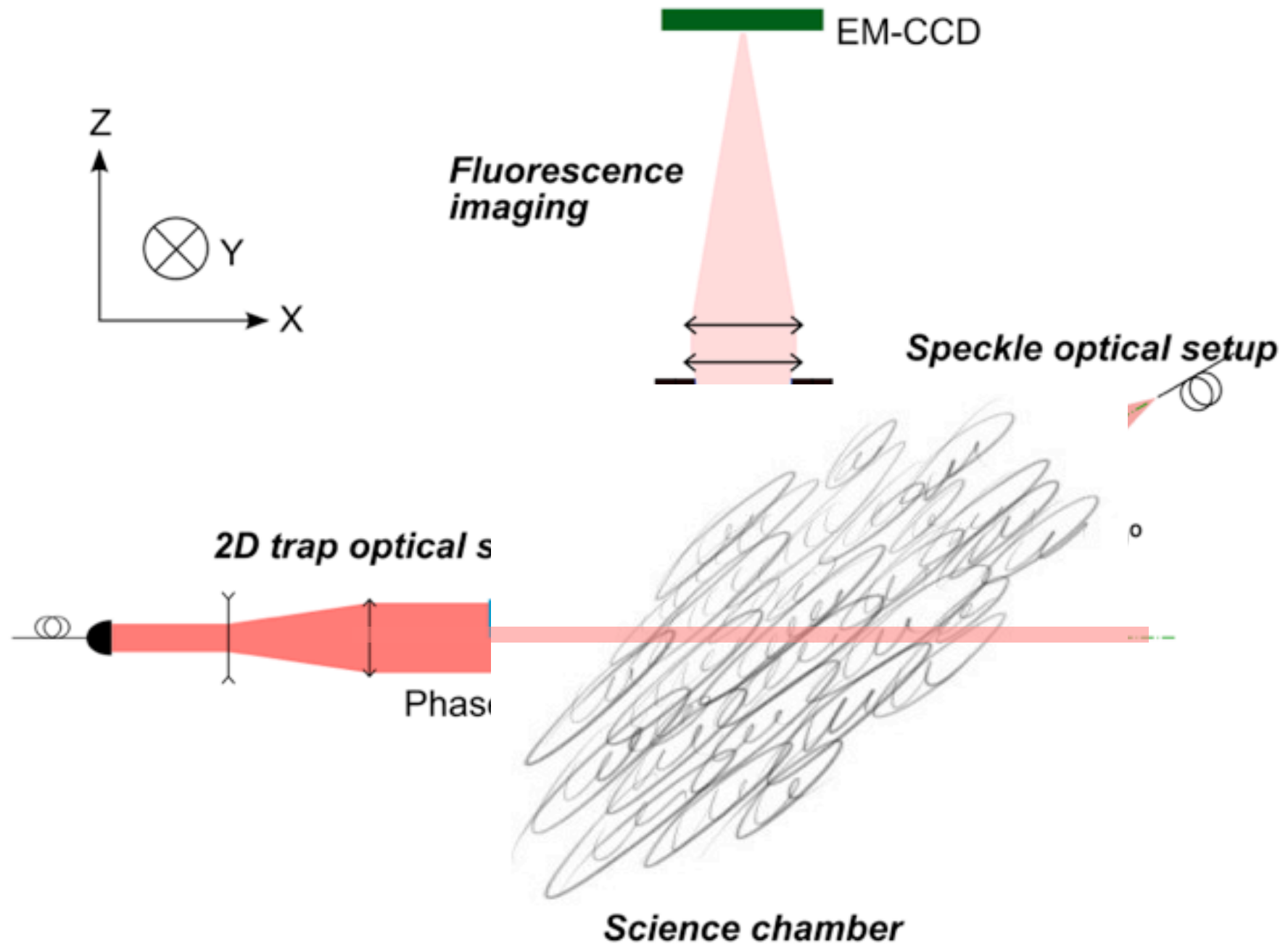

without disorder

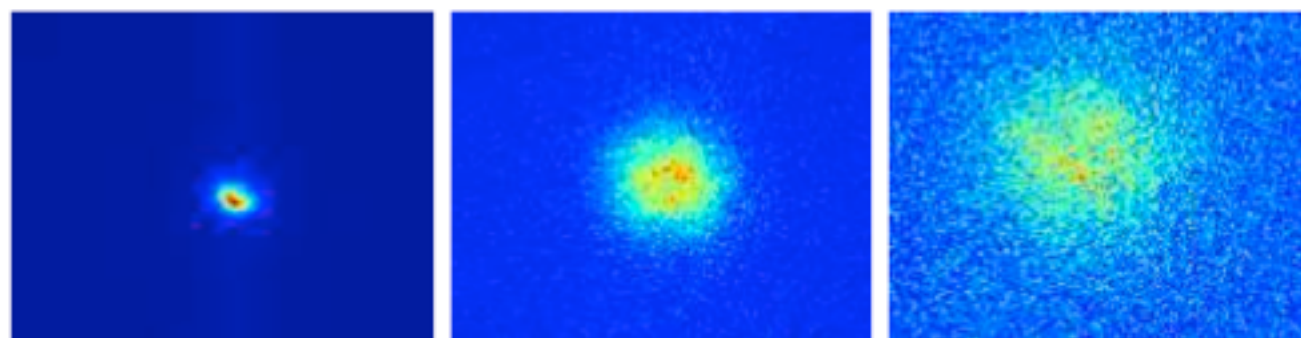

with disorder

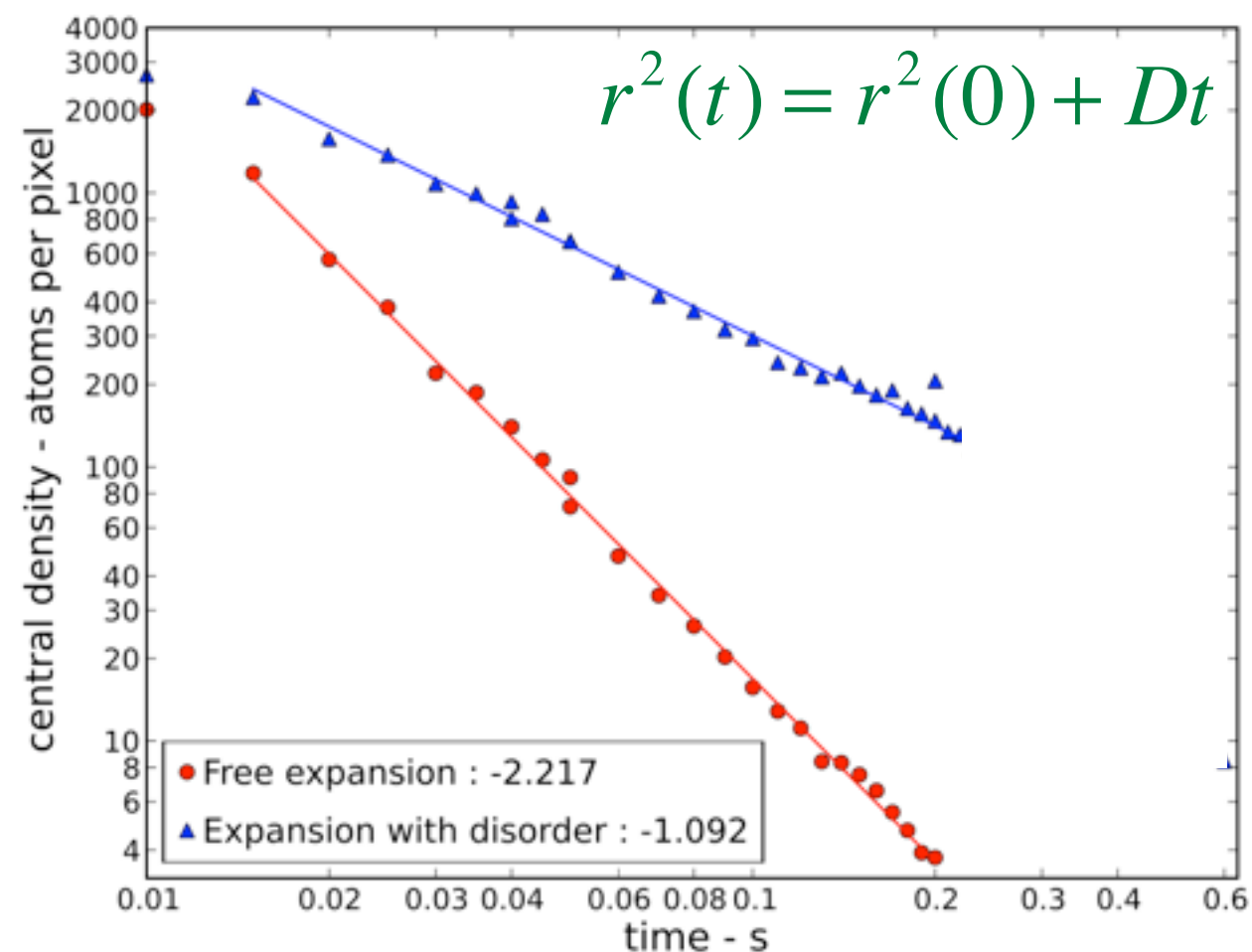
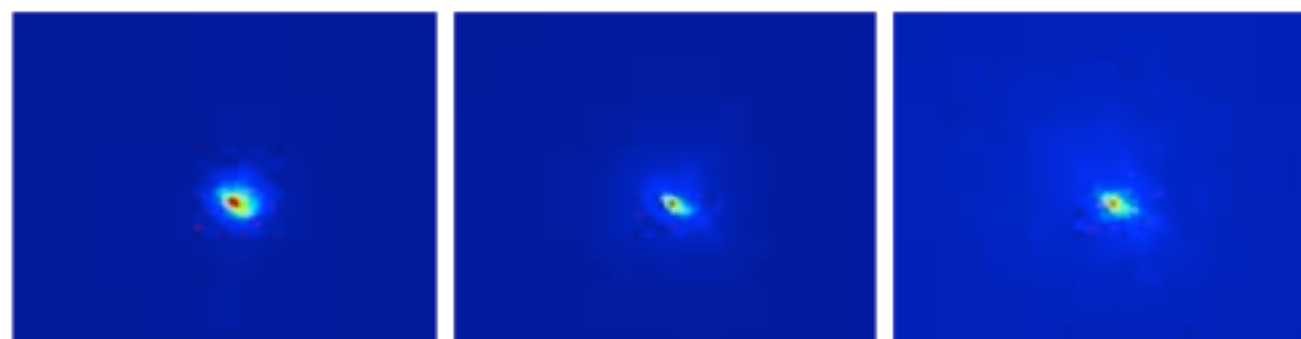

$$r^2(t) = r^2(0) + \frac{k_B T}{M} t^2$$

2D density scales as $1/r$

Since $k_B T / \hbar \omega \approx 6$ and $k \sigma_y \approx 5$, we expect classical dynamics

3 regimes present during the expansion :

Below percolation threshold ($E \approx 0.5$ V) : trapping

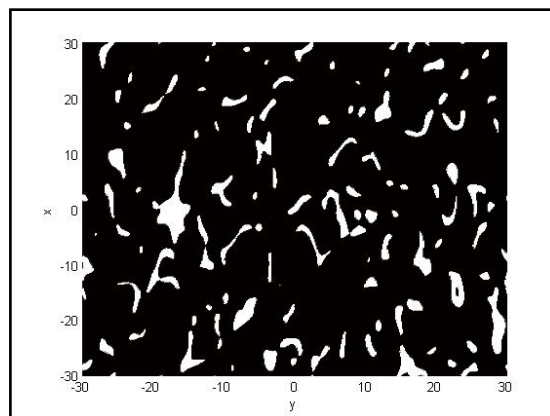

$E/V=0.1$

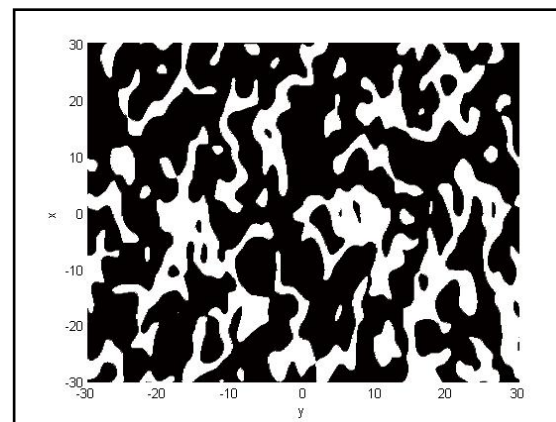

$E/V=0.4$

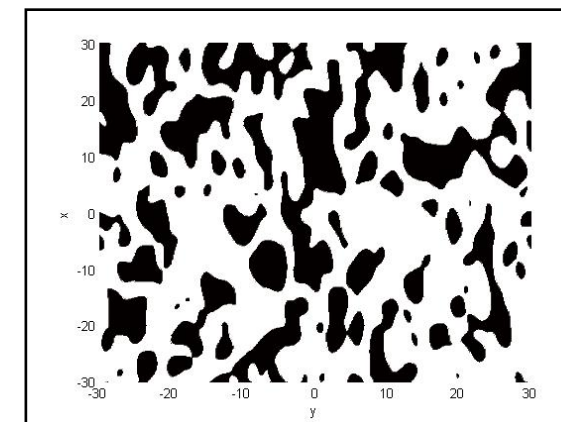

$E/V=1$

L.N. Smith and C.J. Lobb, PRB 1979

A. Weinrib PRB 1982

Since $k_B T / \hbar \omega \approx 6$ and $k \sigma_y \approx 5$, we expect classical dynamics

3 regimes present during the expansion :

Below diffusion threshold ($E \approx 2$ V) : sub-diffusion

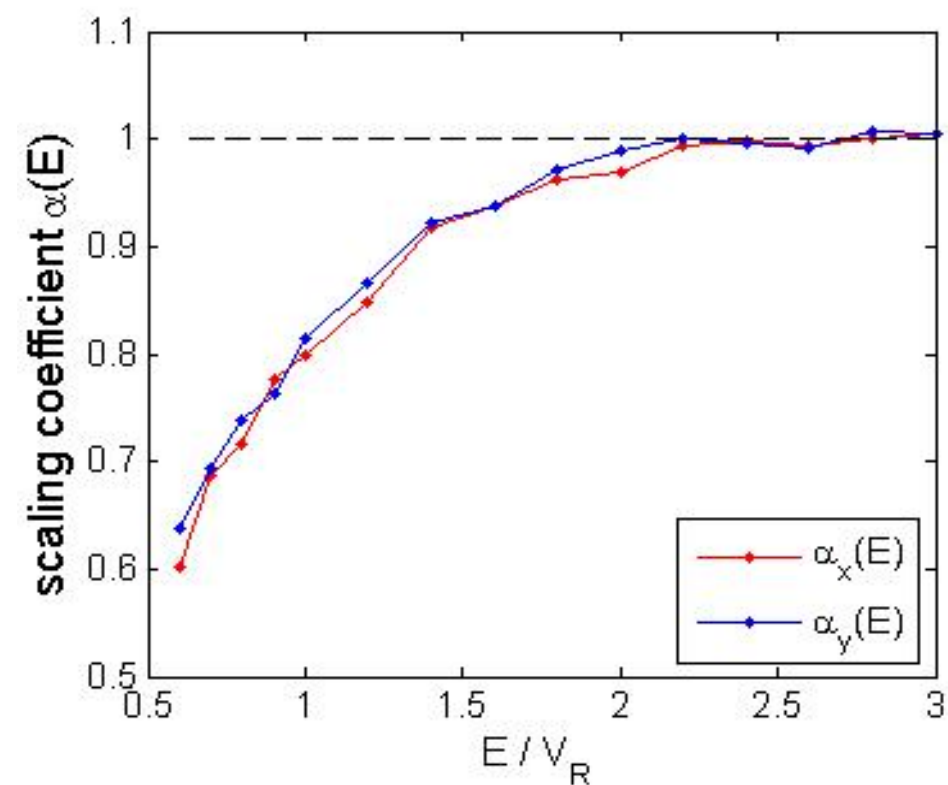
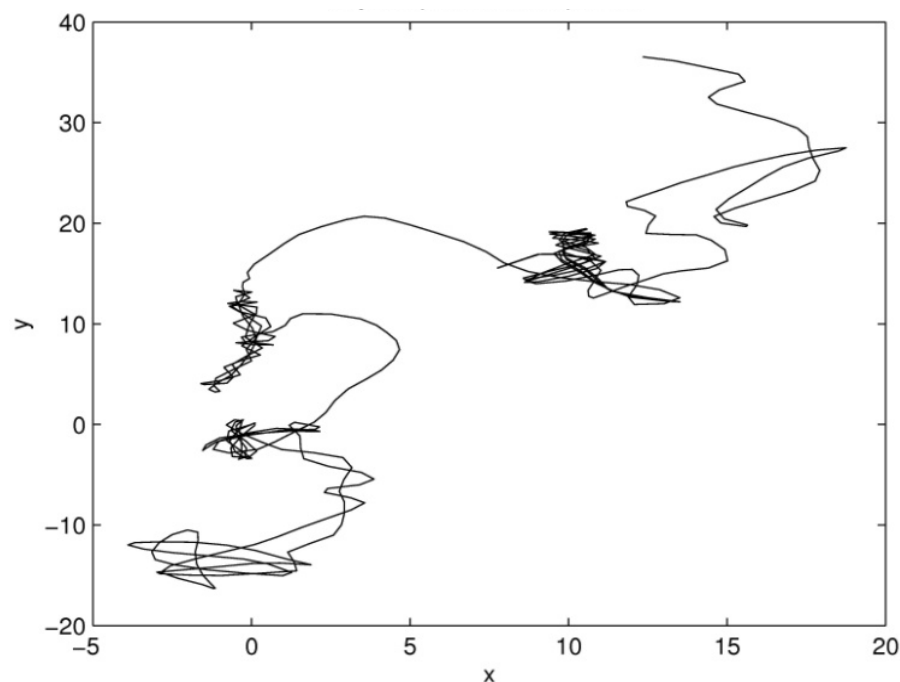

Since $k_B T / \hbar \omega \approx 6$ and $k \sigma_y \approx 5$, we expect classical dynamics

3 regimes present during the expansion :

Diffusion

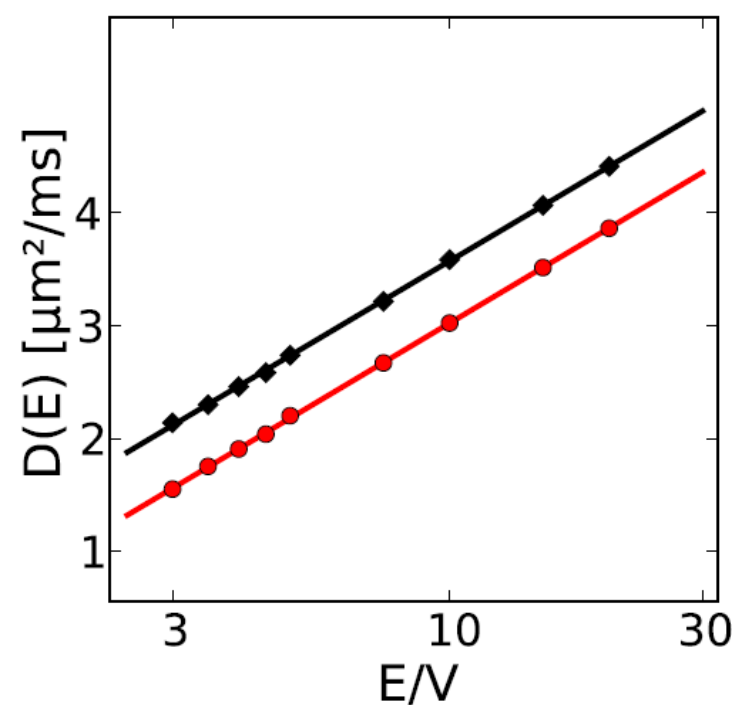
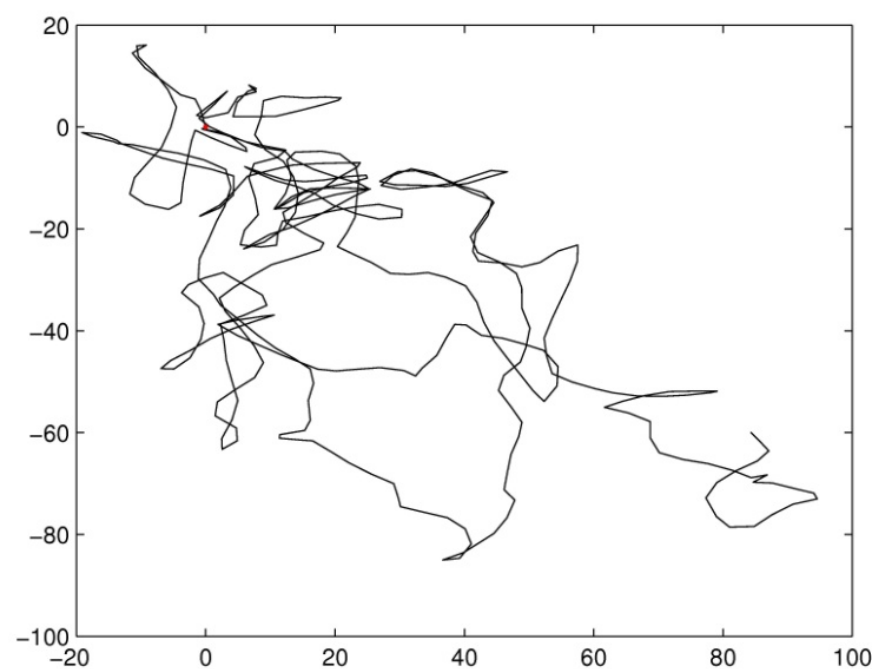

$$D_\xi(E) = D_\xi^0 (E/\bar{V})^{\gamma_\xi}$$

$$\gamma_\xi = 2.8$$

anisotropy of 3.7

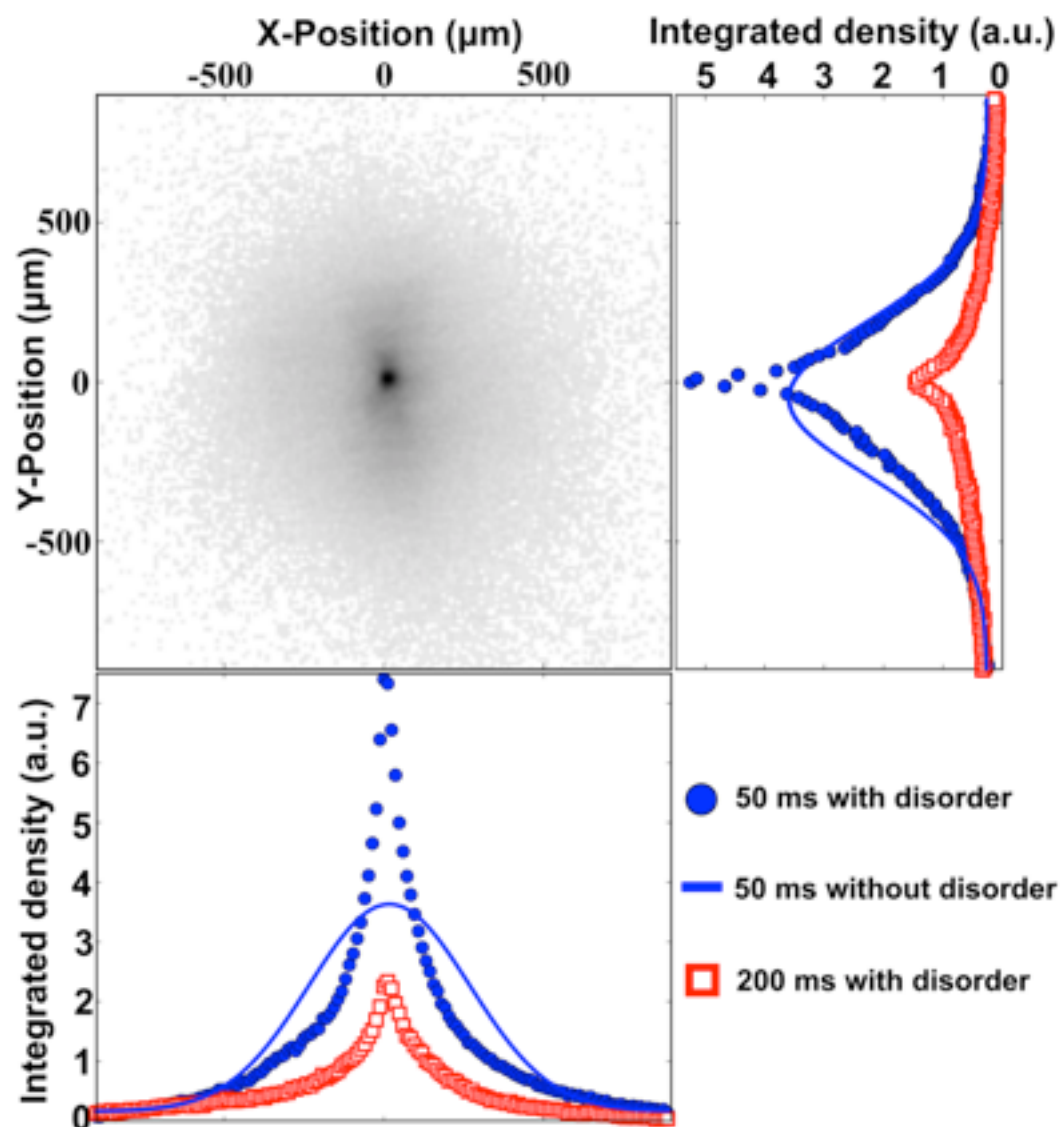

Exp: $\gamma=3.3(3)$

Th: $\gamma_{\text{th}}=2.8$

Anisotropy ratio:

Exp: $3.45(15)$

Th: 3.7

Profiles contain ballistic wings
+ diffusive central part

Diffusion coefficients : $D_{x,y}(E)$
Profile = $\text{sum}_E \left(e^{\frac{-r^2}{D(E)t}} \right)$

Pb : what is $D(E)$?

weak scattering : $D(E) \sim D_0 E^\alpha$

$D_0 \sim 0.13 \text{ mm}^2 \text{ s}^{-1}$; $\alpha \sim 3$

Understanding the rôle of disorder is fundamental in many field :

- **Optics (wave propagation, random lasers ...), electrons, ...** Storzer et al. Phys. Rev. Lett. 96, 063904 (2006), Schwartz et al. Nature 446, 52 (2007), Lahini, Y. et al. Phys. Rev. Lett. 100, 013906 (2008) ...
- **On cold atoms, many experiment using the “mapping” from quantum chaos (dynamical localisation) has been used** : Moore et al. PRL (1994), Chabé et al. (2007) ...
- **There are now many experiments studying BEC and disorder, adressing various aspects (propagation, lattice ...)** : Billy et al. Nature 453, 891(2008), Roati et al., Nature 453, 896 (2008), Chen et al. Physical Review A 77, 033632 (2008), Schulte et al., PRL 95, 170411(2005), White et al arxiv:0807.0446 (2008)

With atoms and disorder we can simulate transport in various configurations:

- **Possibility to control all matter-wave parameter (velocity, density, interactions ...)**
- **Very good control and understanding on the disorder model (Speckle pattern well characterized ...)**

Direct observation of wavefunction, correlation functions ...



Anderson localisation in the atom optics group (A. Aspect, www.atomoptic.fr)

**Theory : L. Sanchez Palencia,
P. Lugan, B. Hambrecht, L. Pezze**

Experiments : P. Bouyer

1D and 3D : V. Josse

J. Billy, A. Bernard, P. Cheinet, F. Jendrzejewski, S. Seidel

2D and controllable interactions : T. Bourdel

J-P Brantut, M. Robert de Saint Vincent, JF Clément, T. Plisson, B. Allard



web site : www.atomoptic.fr

