



HAL
open science

Matter Waves: from quantum simulators to tests of general relativity

Philippe Bouyer

► **To cite this version:**

Philippe Bouyer. Matter Waves: from quantum simulators to tests of general relativity. Mesoscopic Physics in Complex Media, Jul 2010, Cargèse, France. hal-00502396

HAL Id: hal-00502396

<https://hal.science/hal-00502396>

Submitted on 14 Jul 2010

HAL is a multi-disciplinary open access archive for the deposit and dissemination of scientific research documents, whether they are published or not. The documents may come from teaching and research institutions in France or abroad, or from public or private research centers.

L'archive ouverte pluridisciplinaire **HAL**, est destinée au dépôt et à la diffusion de documents scientifiques de niveau recherche, publiés ou non, émanant des établissements d'enseignement et de recherche français ou étrangers, des laboratoires publics ou privés.



MATTER WAVES : FROM QUANTUM SIMULATORS TO TESTS OF GENERAL RELATIVITY

P. BOUYER

Laboratoire Charles Fabry de l'Institut d'Optique
Palaiseau, France



- ✓ Atom Interferometry consists in physical phenomena where the wave nature of atoms (and in particular the external degrees of freedom) is concerned.
 - ⇒ Analogous to light waves phenomena, but for de Broglie waves

$$\lambda_{opt} \Rightarrow \lambda_{dB} = \frac{h}{m v_{at.}}$$

- ⇒ More generally understood as interferences between quantum paths

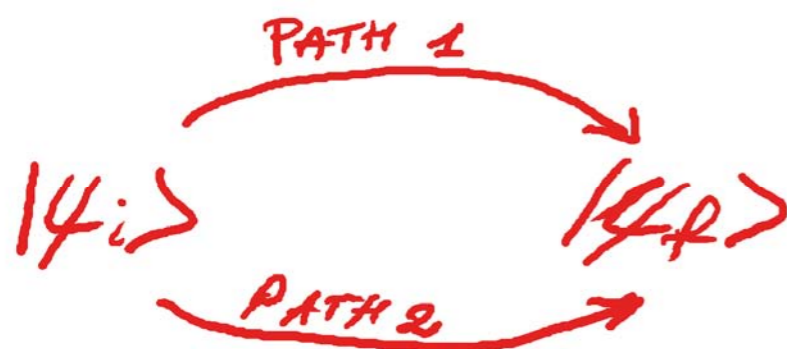

$$\text{PATH 1: } |\mathcal{A}_I|^2 \langle \psi_f | \psi_i \rangle_I^2$$

$$\text{PATH 2: } |\mathcal{A}_{II}|^2 \langle \psi_f | \psi_i \rangle_{II}^2$$

$$\begin{aligned} \text{2 PATHS: } |\mathcal{A}|^2 &= |\mathcal{A}_I + \mathcal{A}_{II}|^2 \\ &= |\mathcal{A}_I|^2 + |\mathcal{A}_{II}|^2 + \\ &\quad 2 \operatorname{Re} \mathcal{A}_I \mathcal{A}_{II}^* \end{aligned}$$

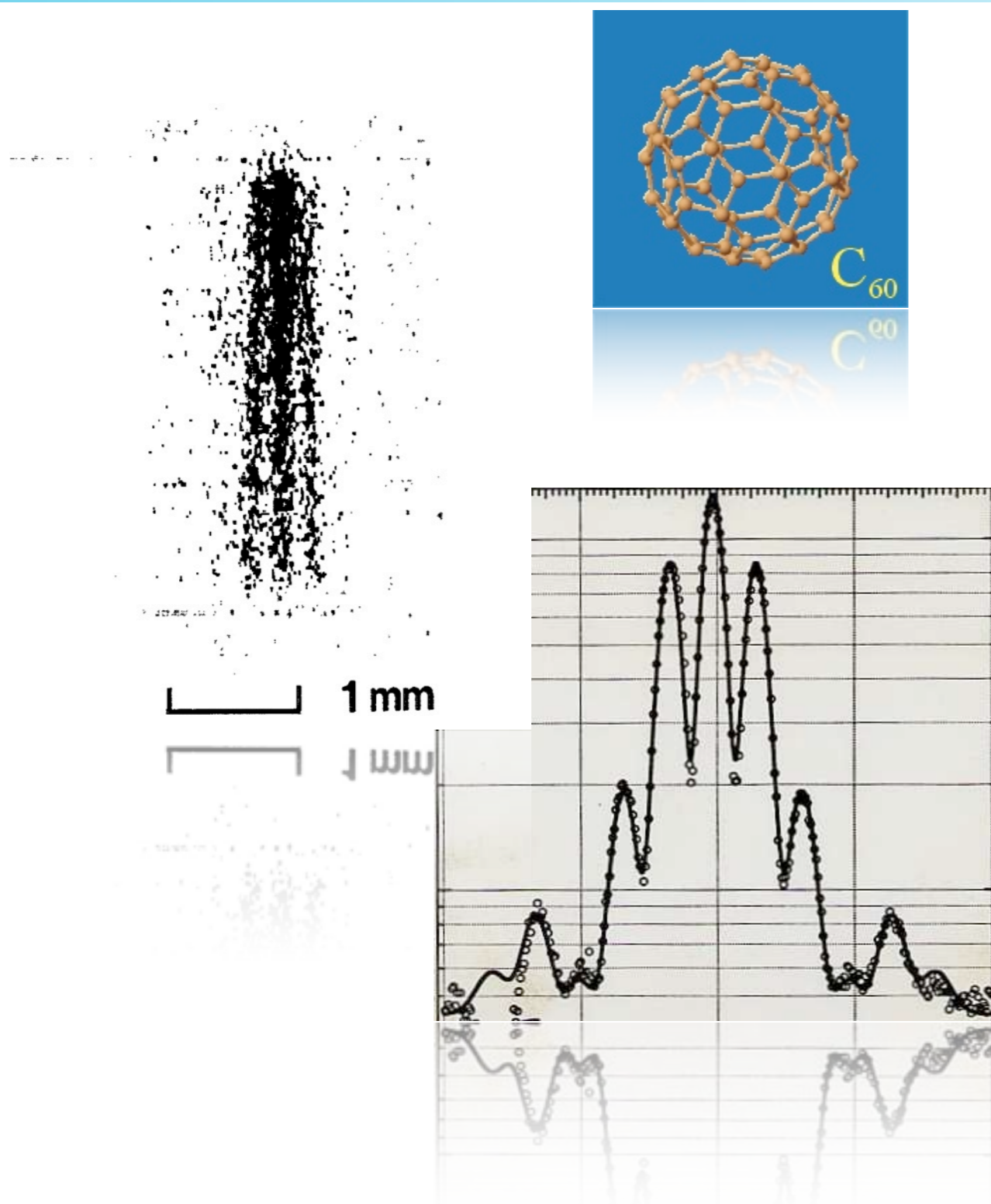

✓ ~1990 : first demonstrations

⇒ Young fringes

⇒ Interferometers with physical gratings

⇒ Interferometers with light gratings

⇒ Interferometers with light pulses

✓ Related to de Broglie waves

⇒ Works with “any kind” of molecules
(even fullerene and eventually viruses)

- ✓ Light is used to cool down atoms : exchange of energy between atoms and light
 - ⇒ **Relies on photon absorption, no coherence, no interferences.**

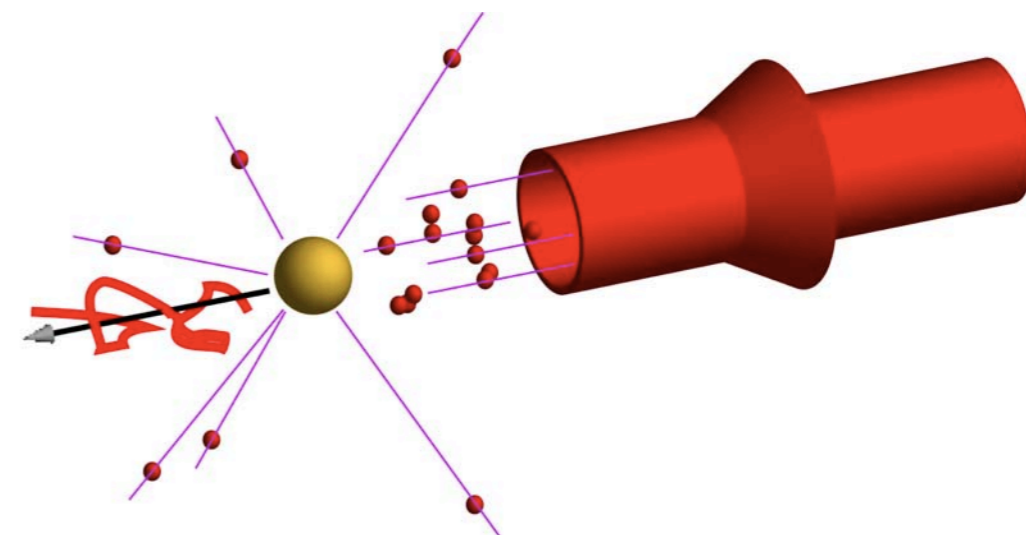

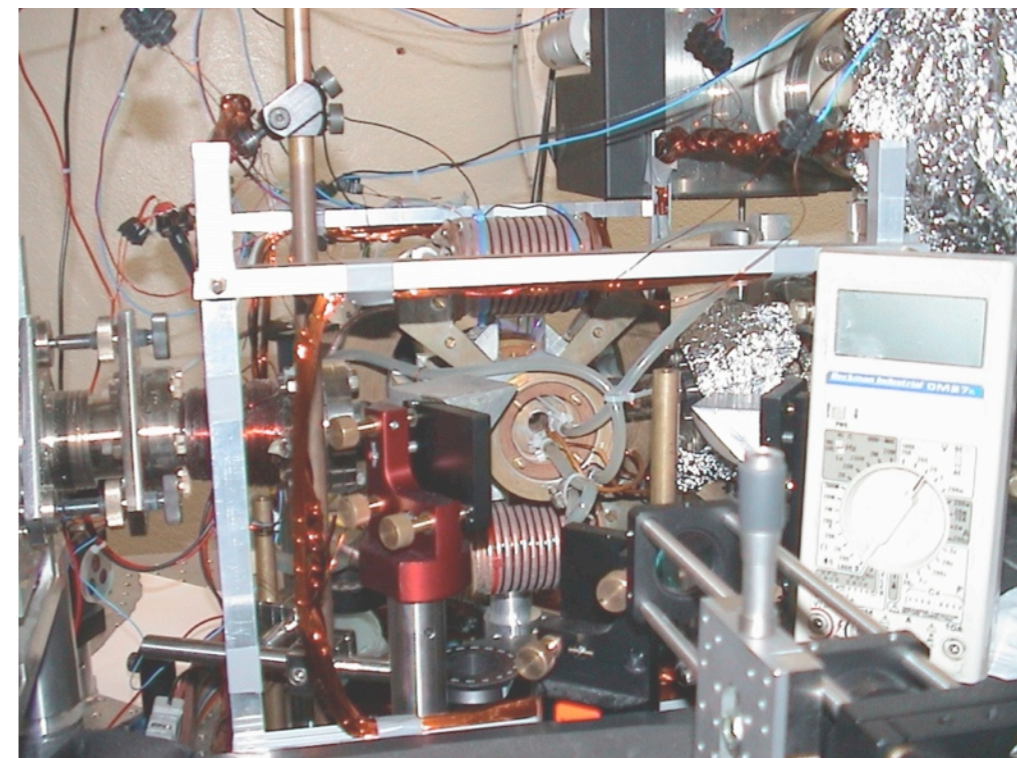
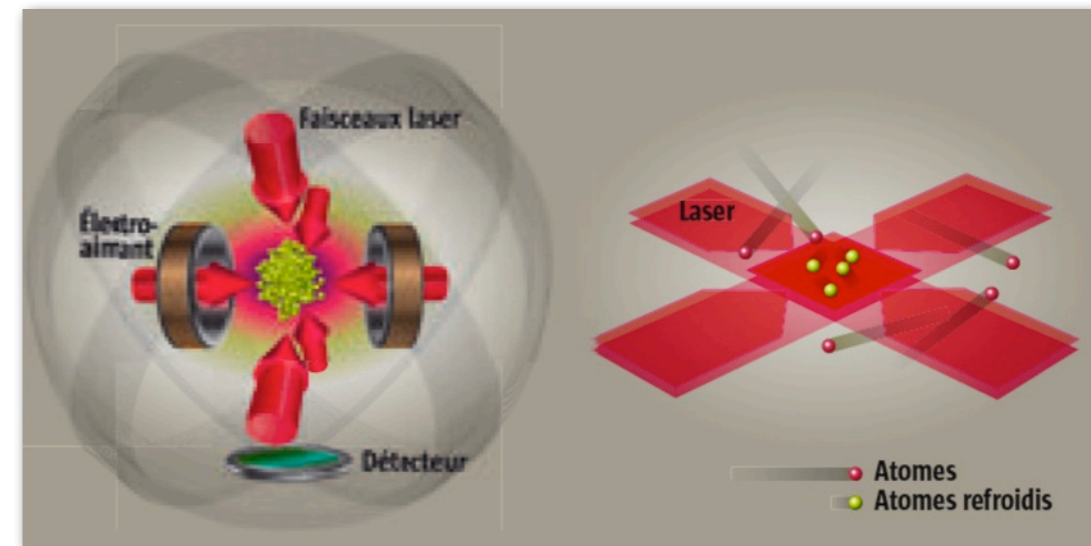
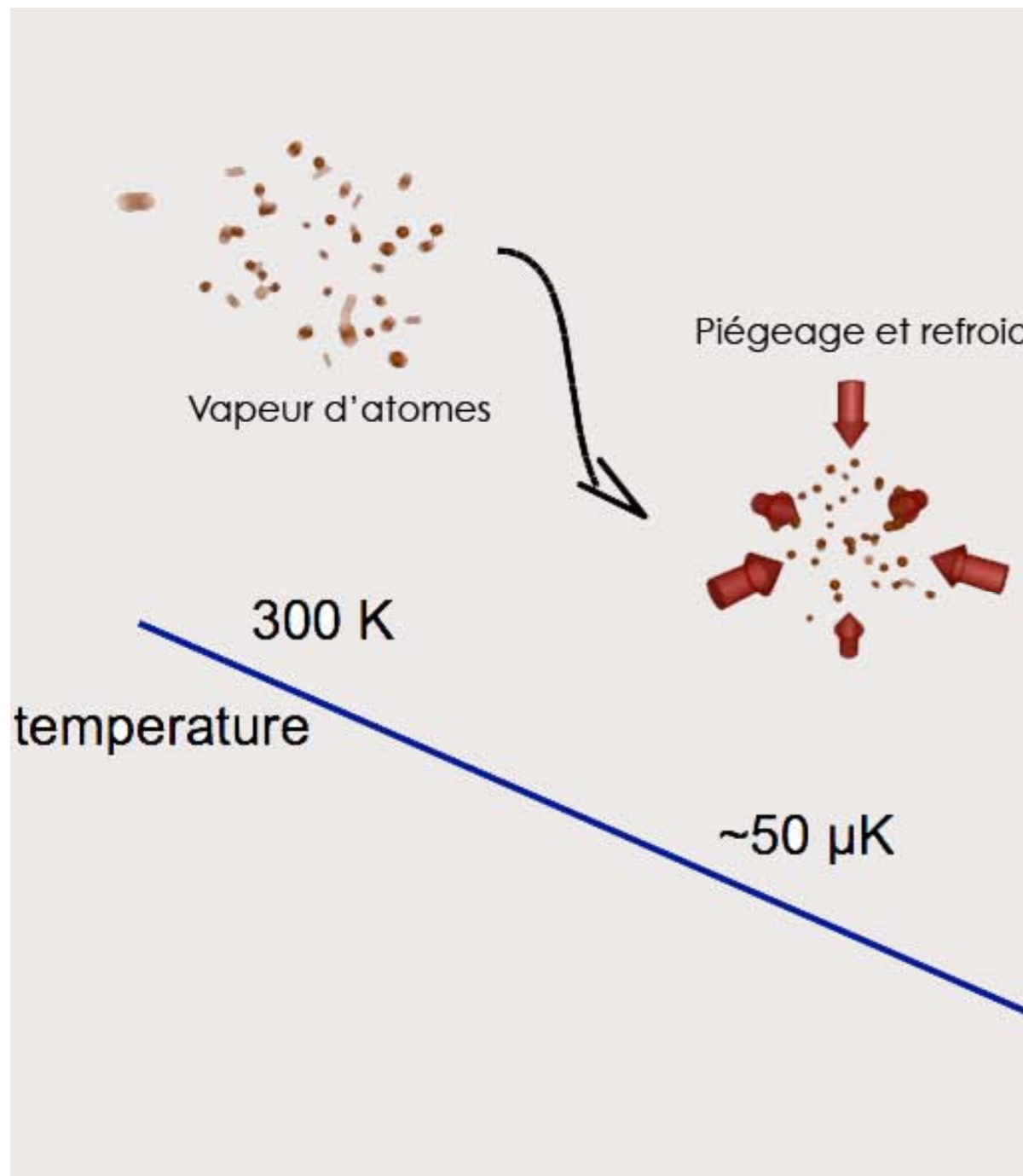

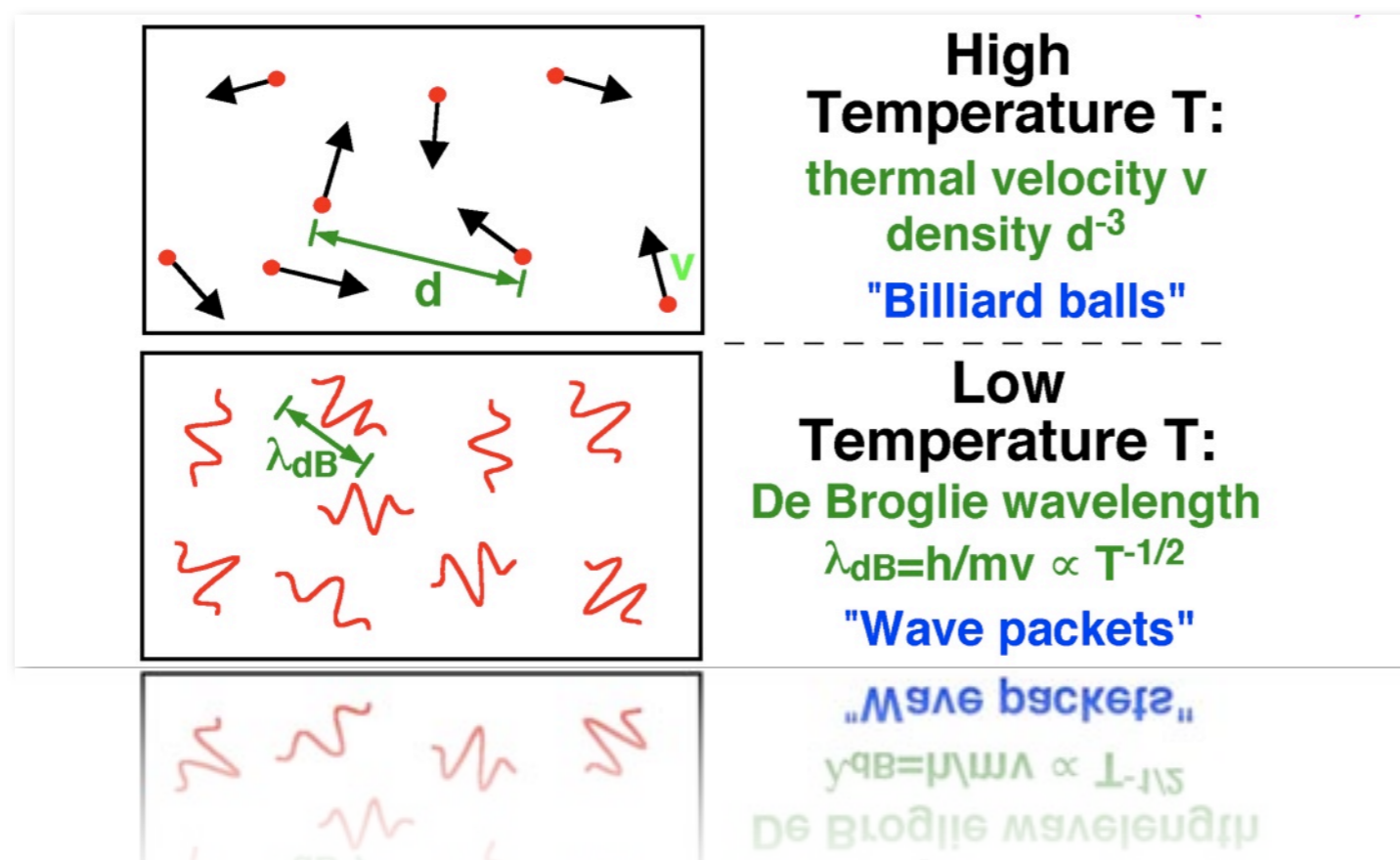

Atoms cooled below 1 μK

Distribution of particles with velocities around mm/s

Distribution on matter waves with de Broglie wavelength $\approx 1 \mu\text{m}$

- ✓ **It is possible to observe atomic diffractions, interferometry ...**

- ✓ Light is used to cool down atoms : exchange of energy between atoms and light
 - ⇒ Relies on photon absorption, non coherent, no interferences.

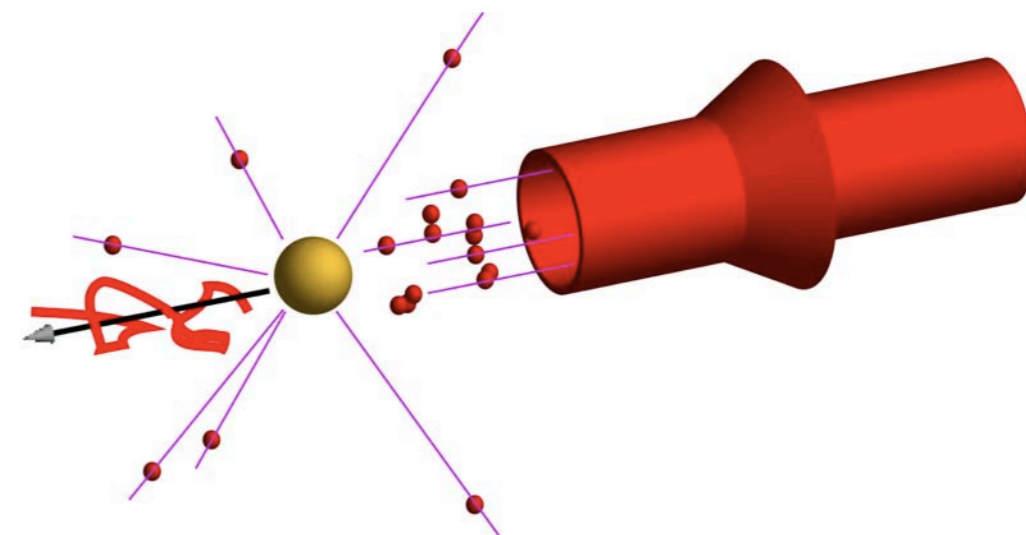

- ✓ Light can be used to manipulate coherently the matter waves

- ✓ Coherent manipulation of atomic states
 - Rabi oscillation (coherent)
 - Photon momentum exchange

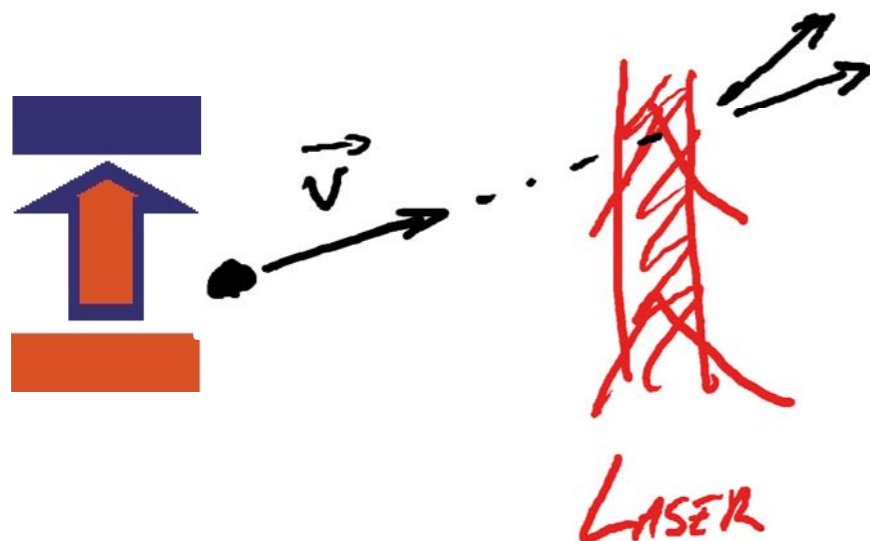

- ✓ Non-dissipative potentials made with light
 - No photon scattering (coherent)
 - Dispersive (dephasing) part of radiative force

$$U = -\mathbf{d} \cdot \mathbf{E} = -\alpha(\omega) E^2$$

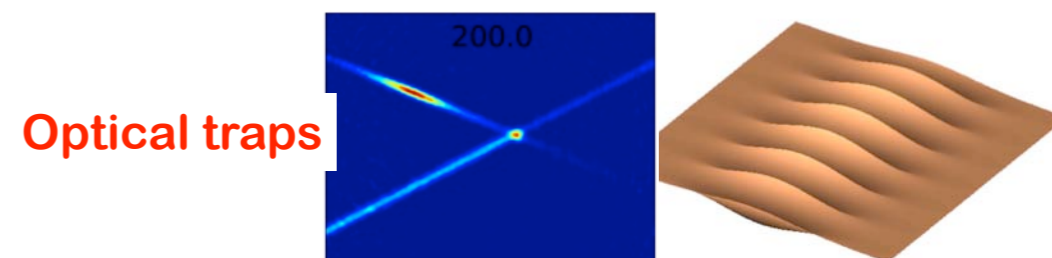

✓ Thanks to our ability to manipulate matter waves, we can create :

⇒ **Coherent beams of atoms, atom lasers.**

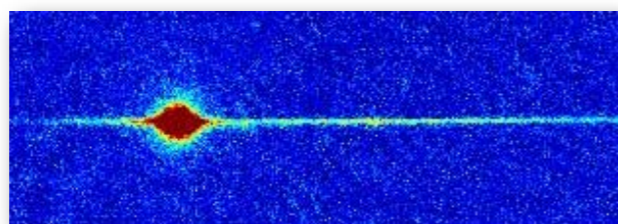

⇒ **Atom interferometers**

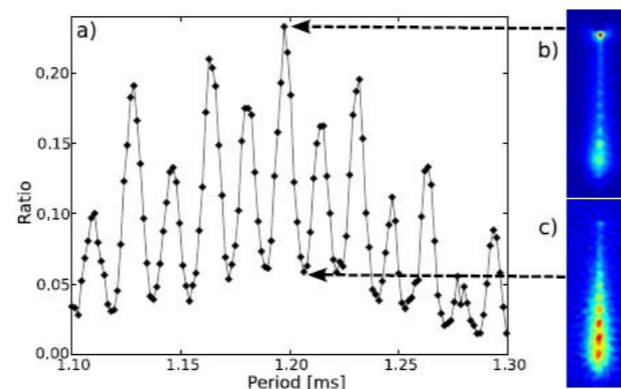

⇒ **Quantum simulators using matter and light**

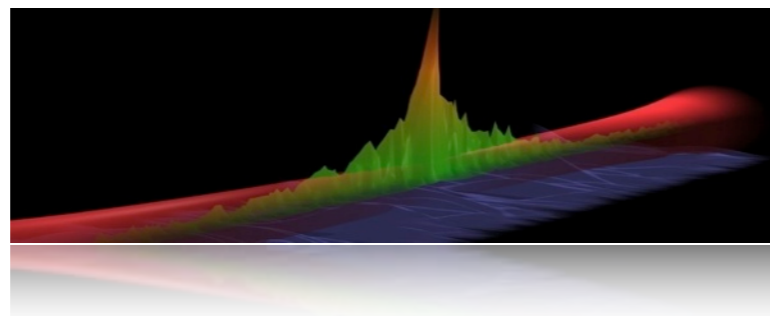

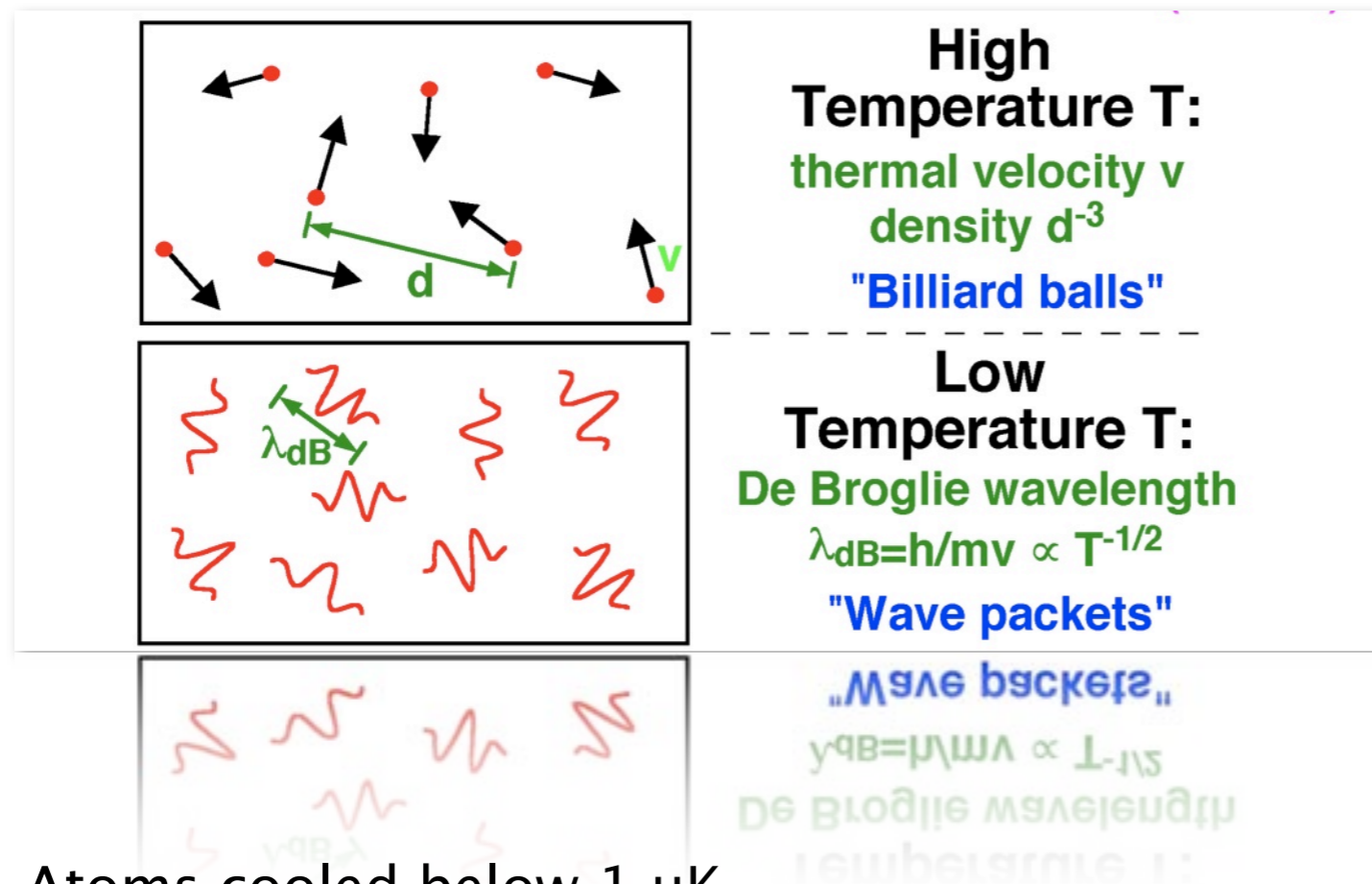

Atoms cooled below 1 μK

Distribution of particles with velocities around mm/s

Distribution on matter waves with de Broglie wavelength $\approx 1 \mu\text{m}$

- ✓ **It is possible to observe atomic diffractions, interferometry ...**

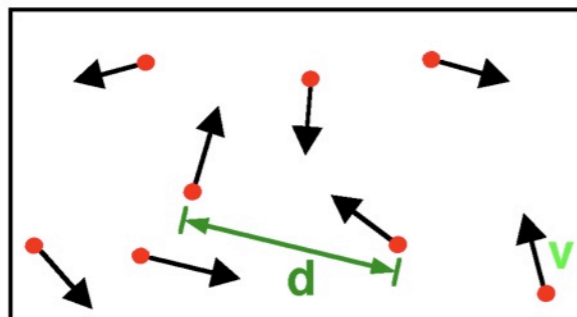

High Temperature T:
thermal velocity v
density d^{-3}
"Billiard balls"

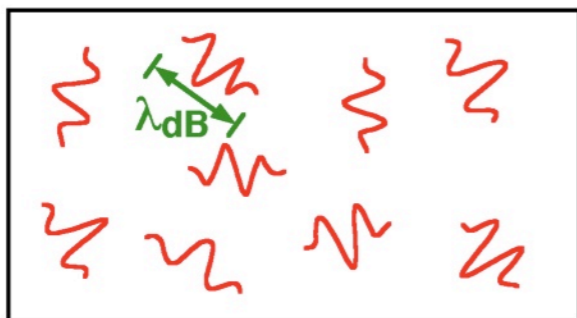

Low Temperature T:
De Broglie wavelength
 $\lambda_{dB} = h/mv \propto T^{-1/2}$
"Wave packets"

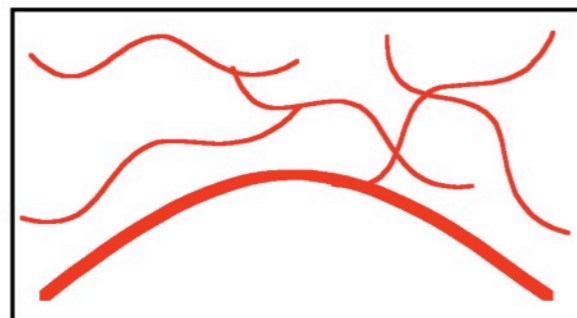

T = T_{crit}:
Bose-Einstein
Condensation
 $\lambda_{dB} \approx d$
"Matter wave overlap"

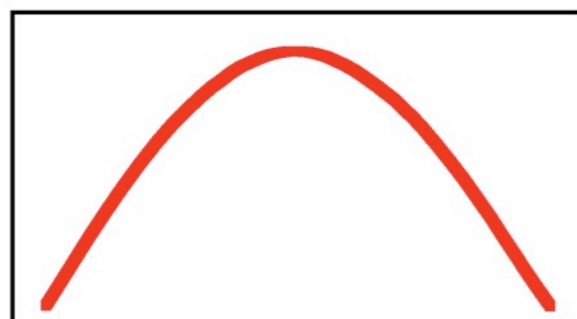

T=0:
Pure Bose
condensate
"Giant matter wave"



"Giant matter wave"
condensate
PURE BOSE

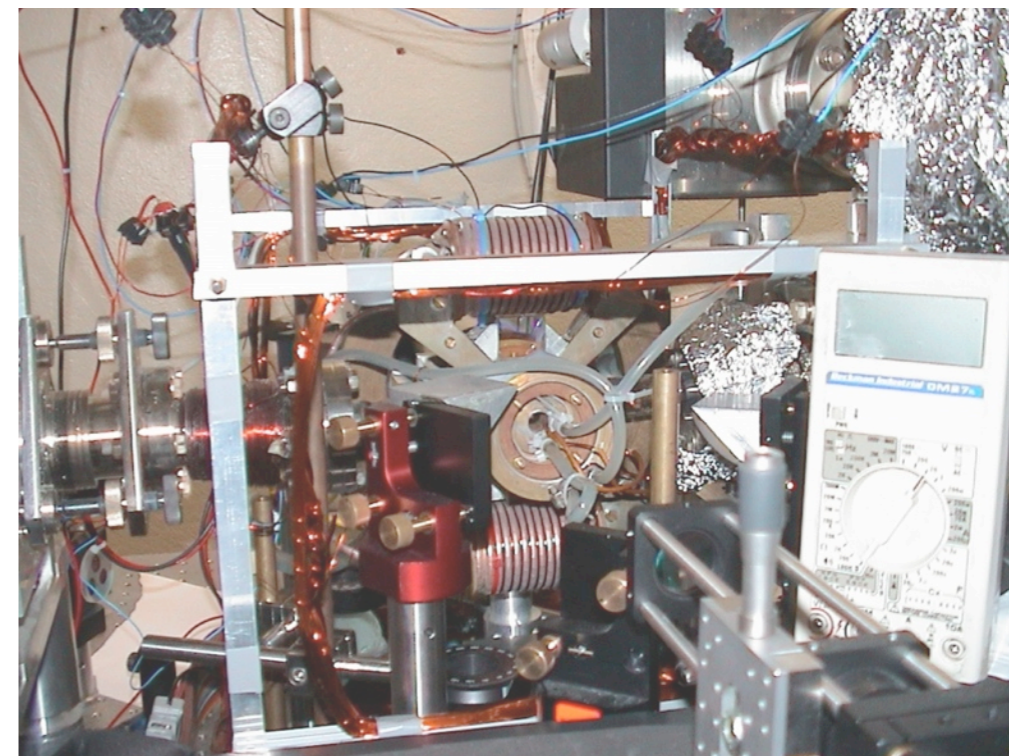
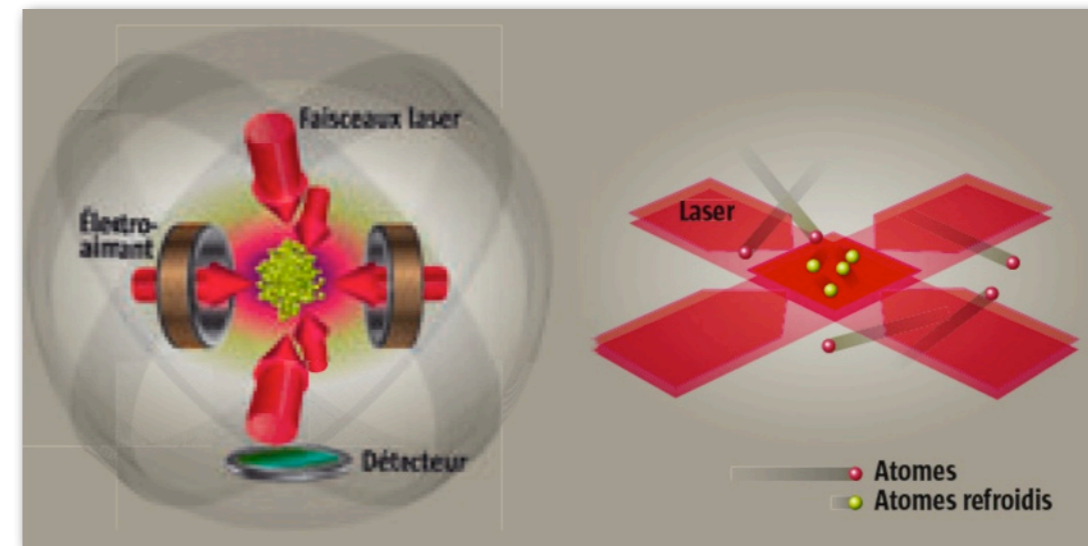
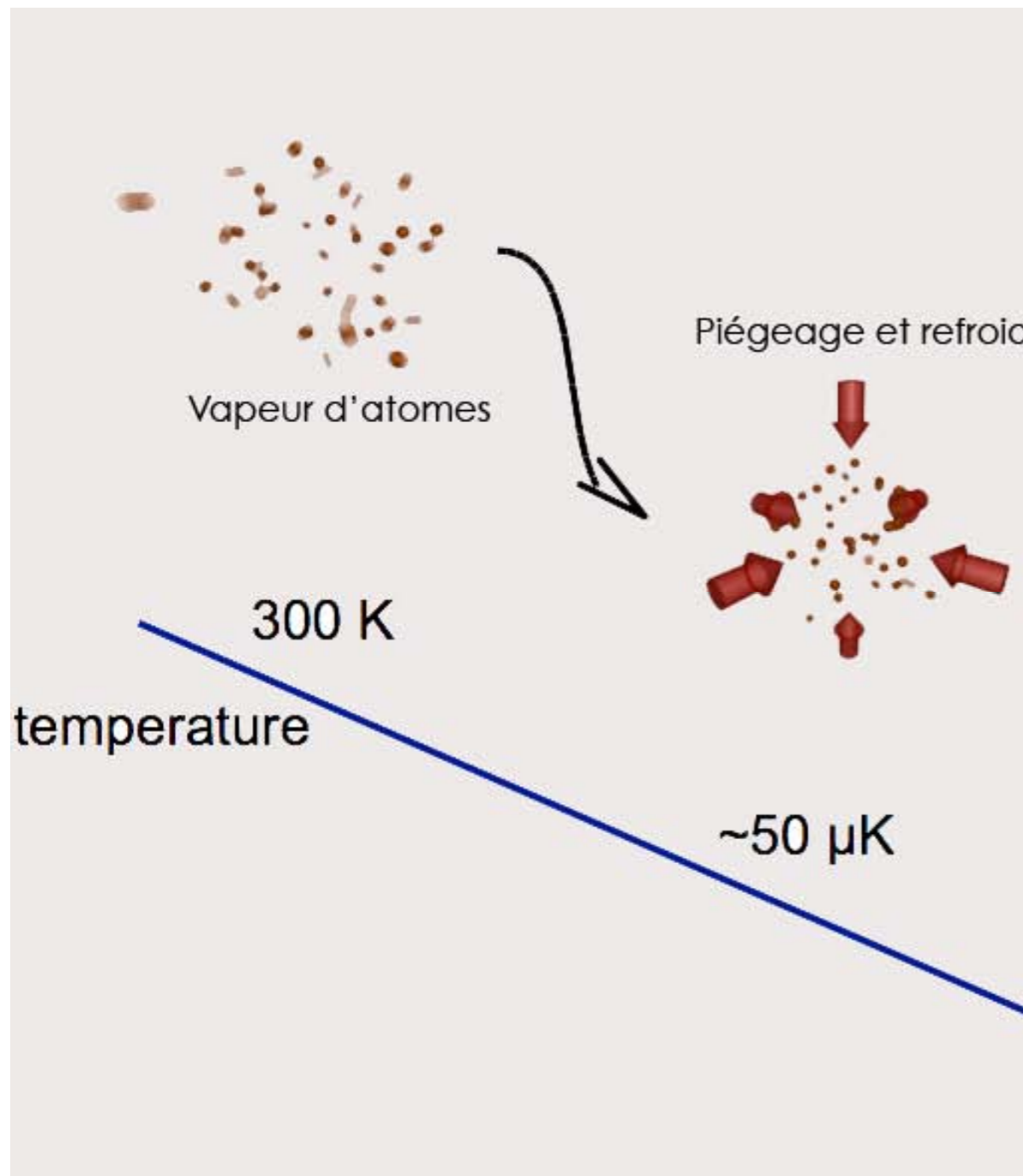

COOLING ATOMS TO BOSE-EINSTEIN CONDENSATION

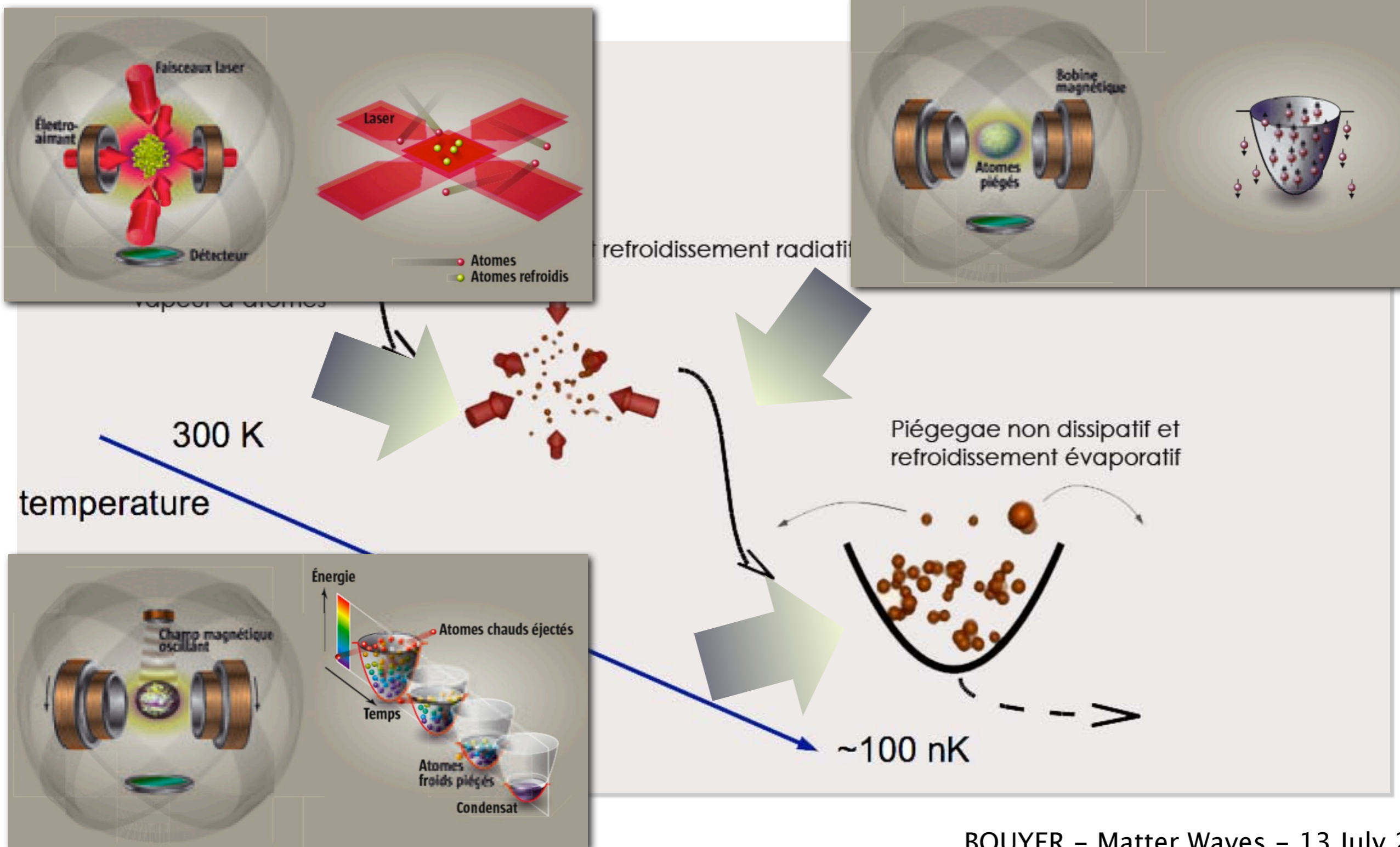

COOLING ATOMS TO BOSE-EINSTEIN CONDENSATION

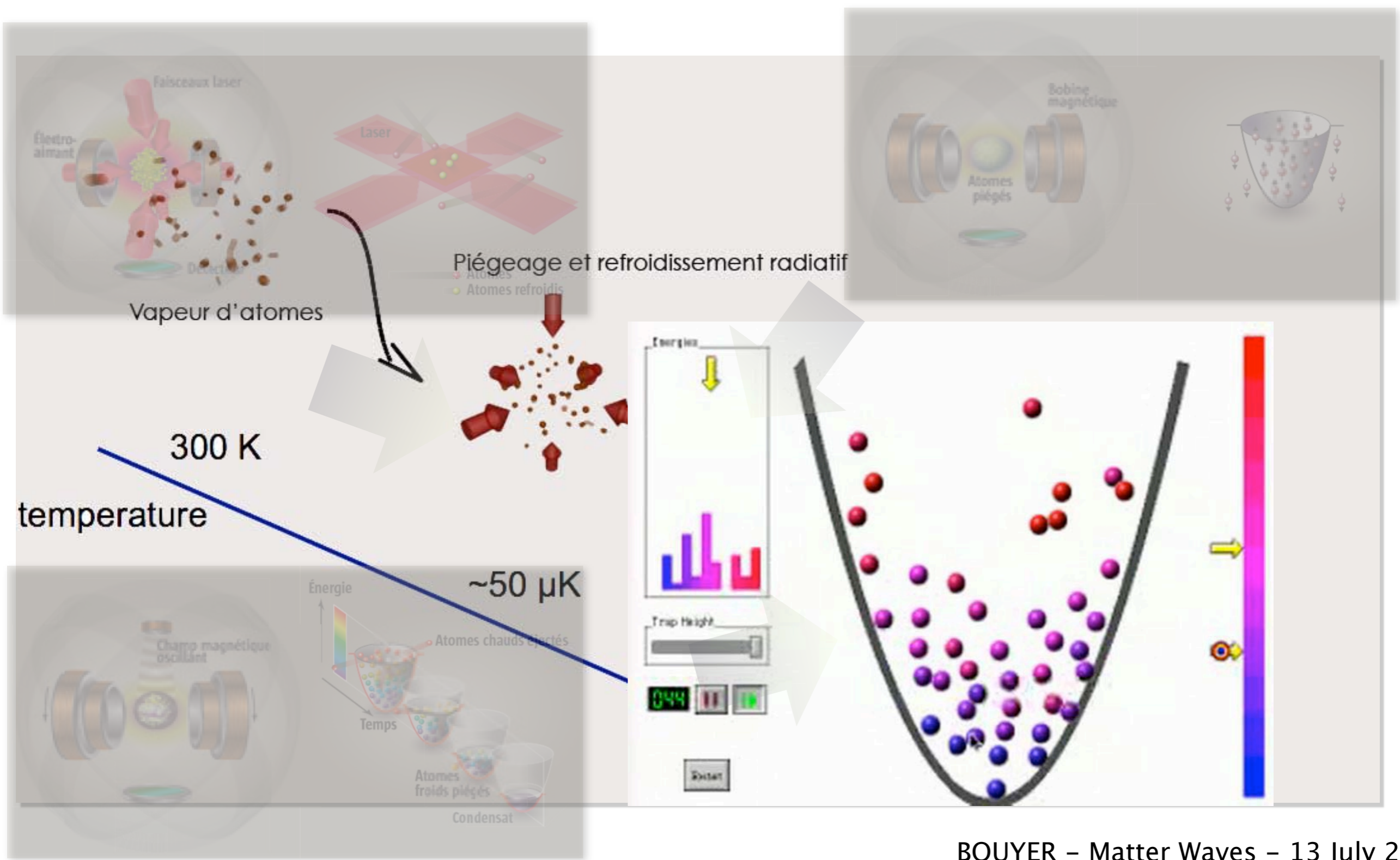

BEC is a coherent matter wave

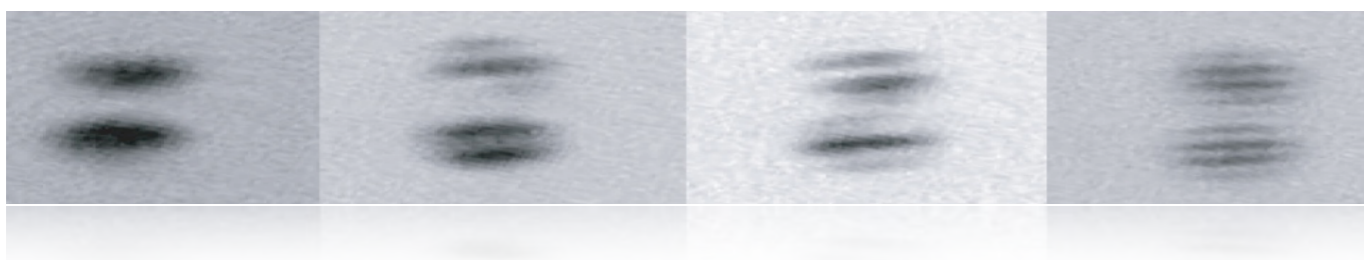

From the light bulb ...

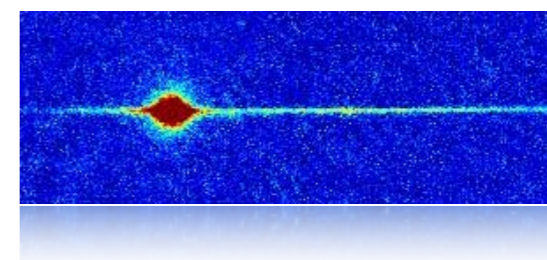

... to the laser

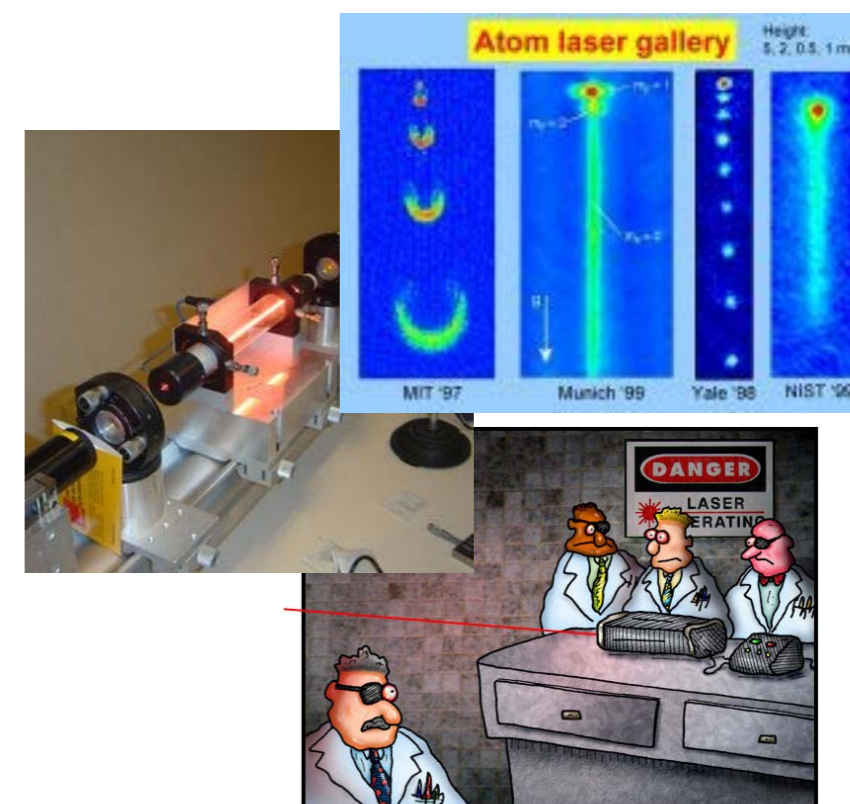
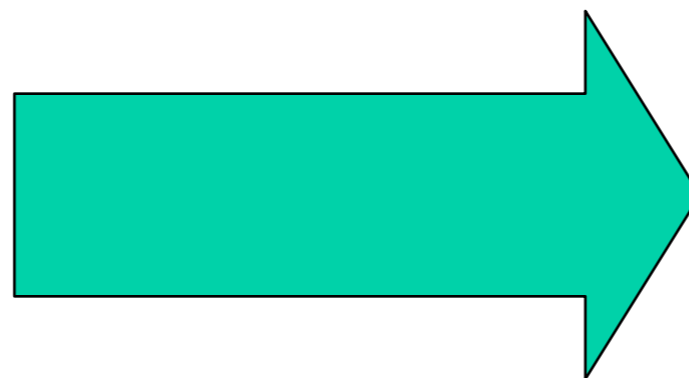

- ✓ An atom interferometer will use a series (at least two) coherent splitting processes to “create” multiple paths that will interfere.

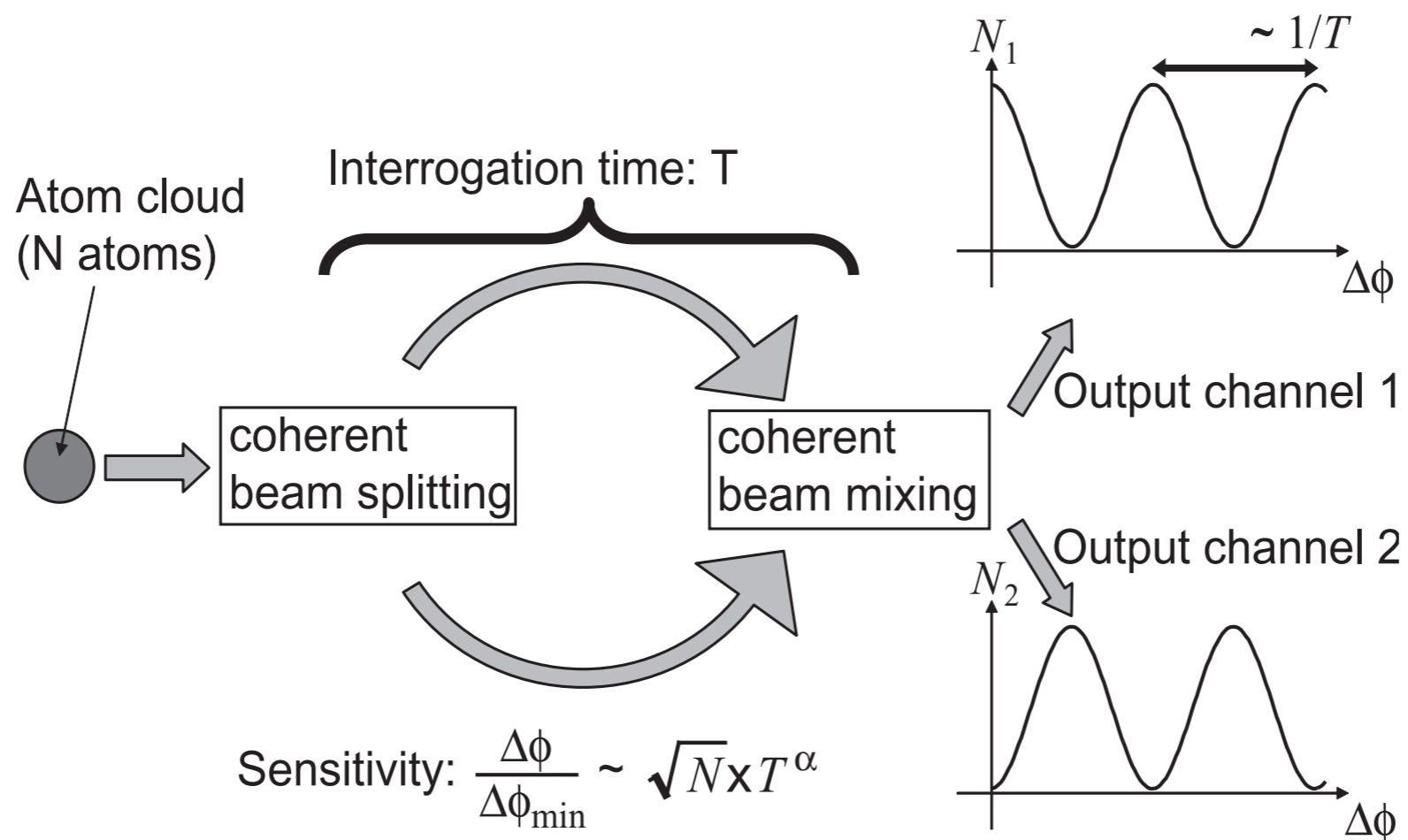

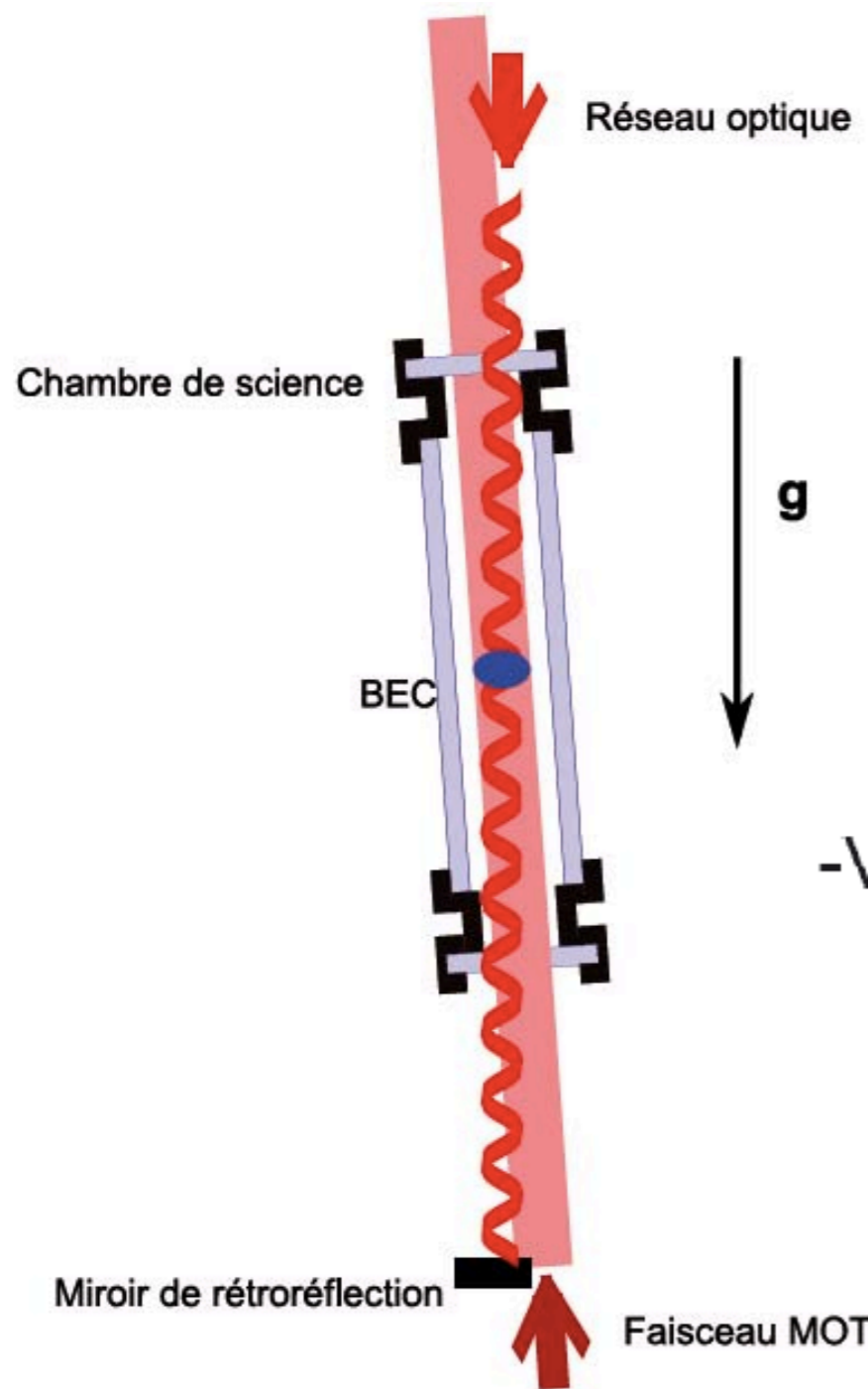

- ✓ Absorption of photon from on laser and stimulated emission to the retroreflected beam
 - ⇒ Rabi oscillation between 2 (or more) state
 - ⇒ Different momenta since photons carry momentum

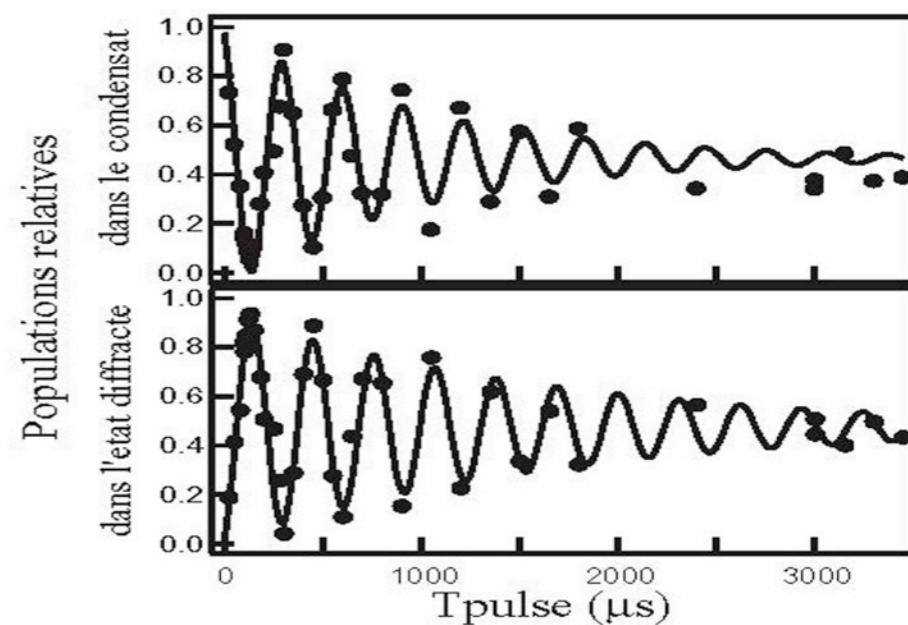
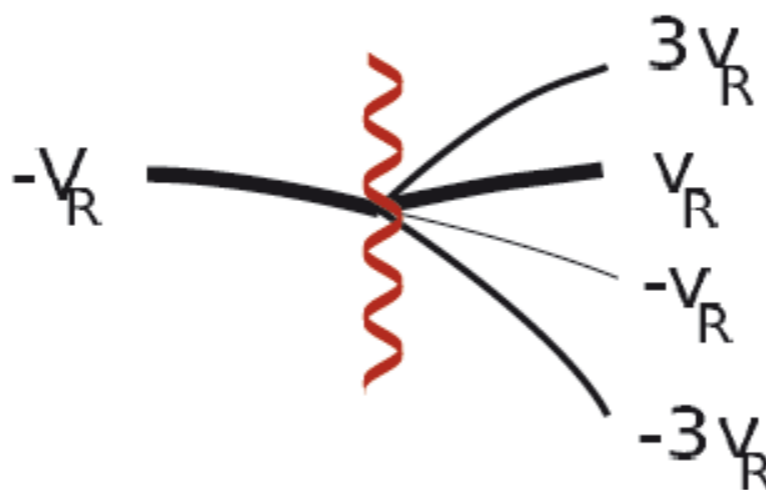

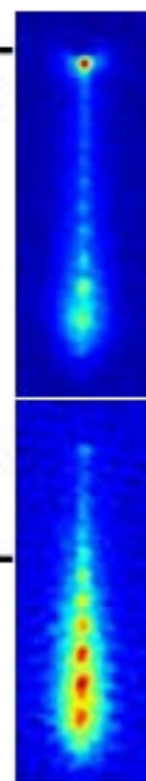
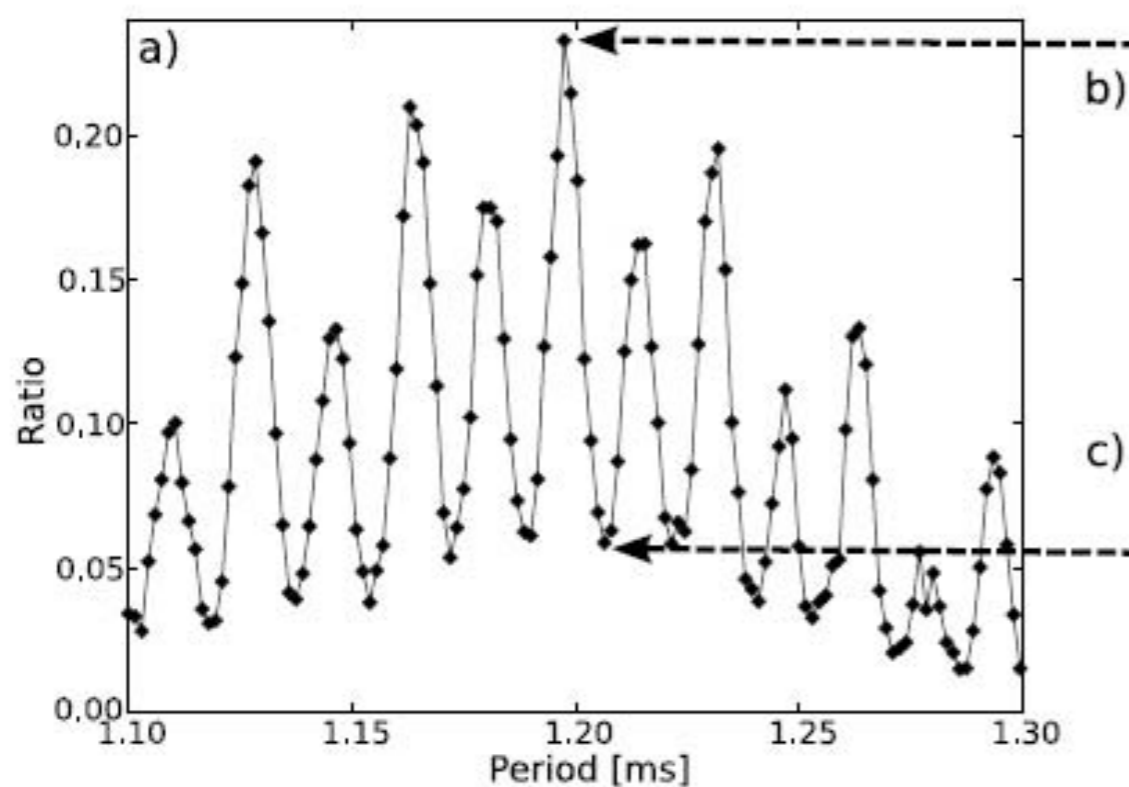
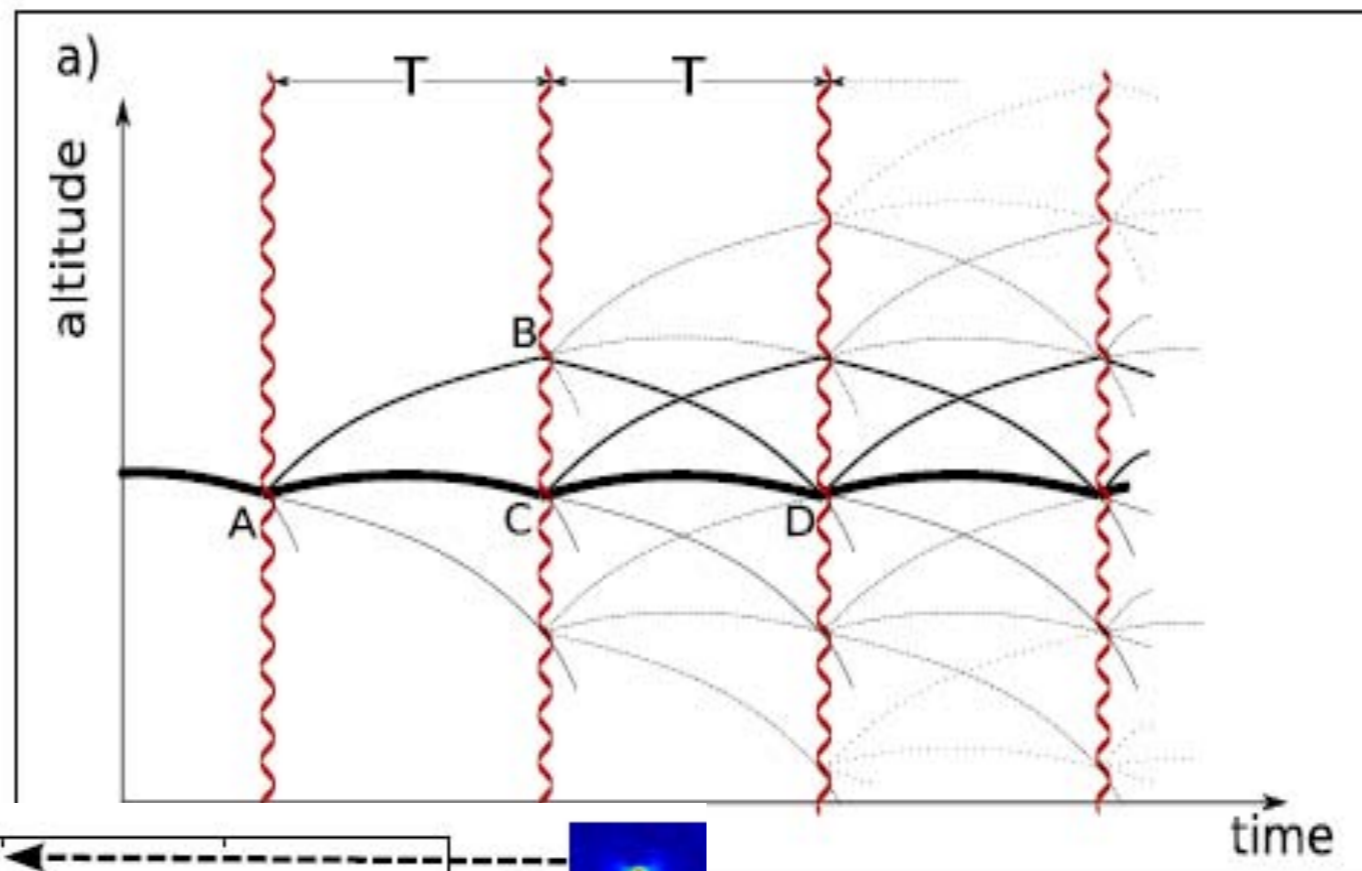

- ✓ Coherence : all the paths interfere
 - ⇒ **The free falling quantum state is forbidden**
 - ⇒ **Quantum levitation**

M. Robert-de-saint-Vincent, et al.
Europhys. Lett., 2010. 89(1): p. 5

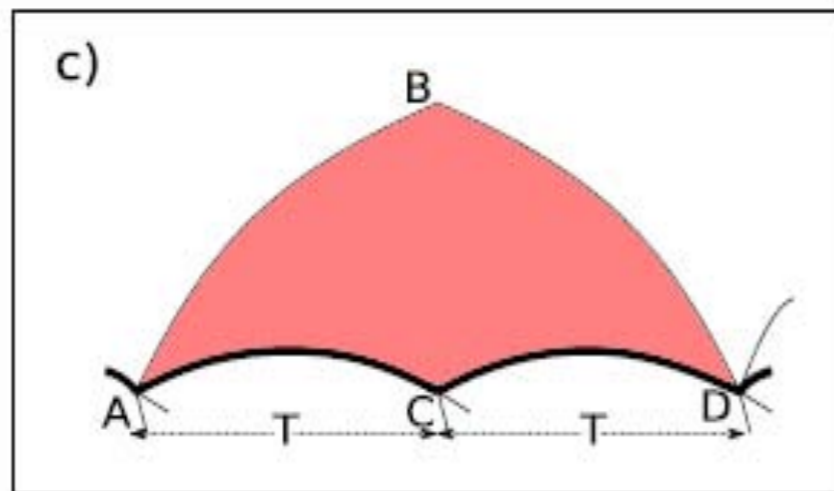
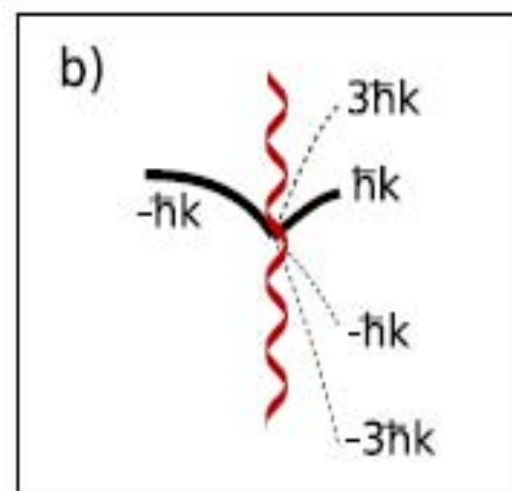
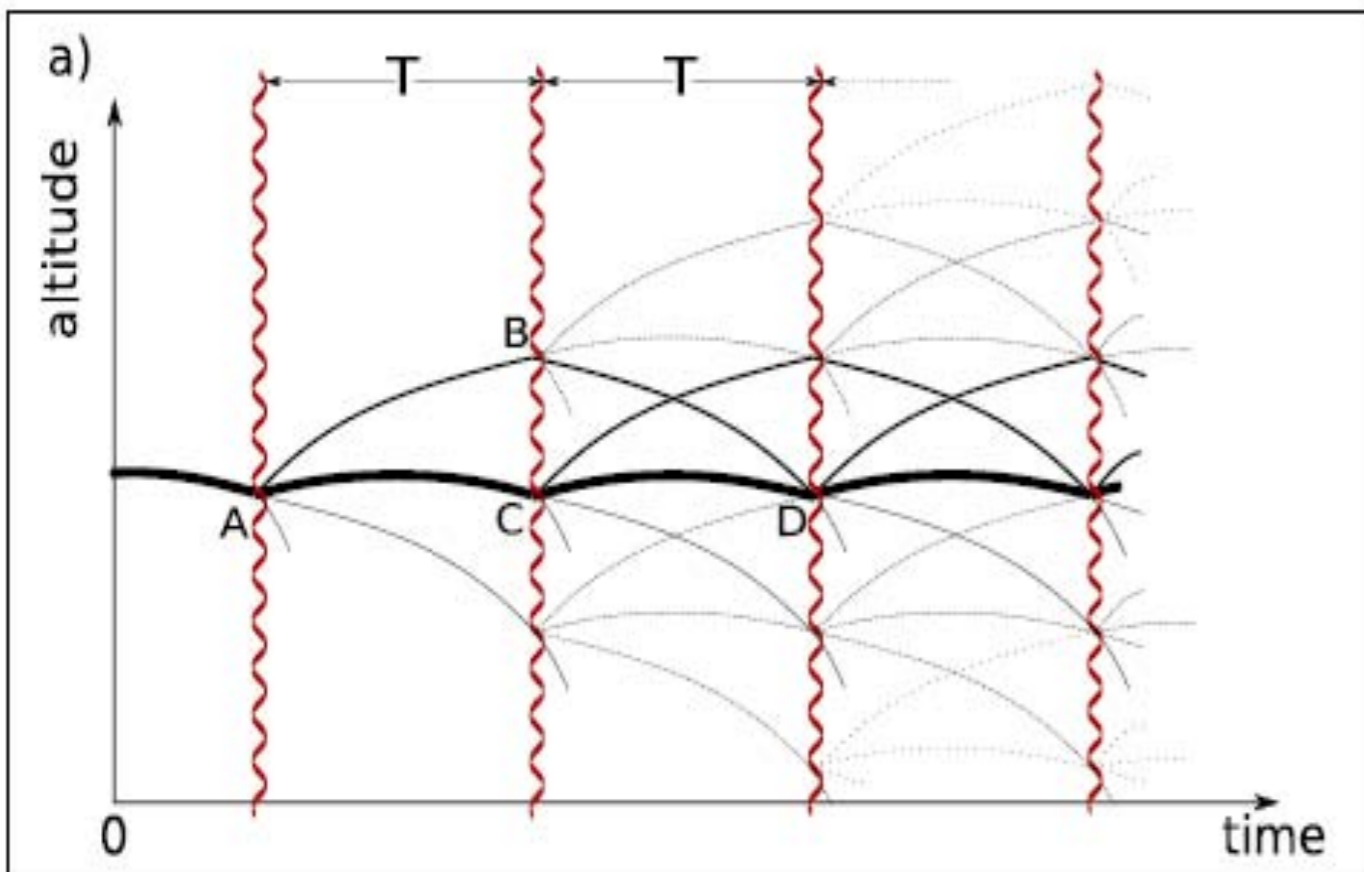

✓ A series of interferometer :

$$\Delta\phi = -2kgT^2 + \delta\phi_0$$

✓ Final fringe separation

$$\Delta T = \frac{\pi}{2kgT}$$

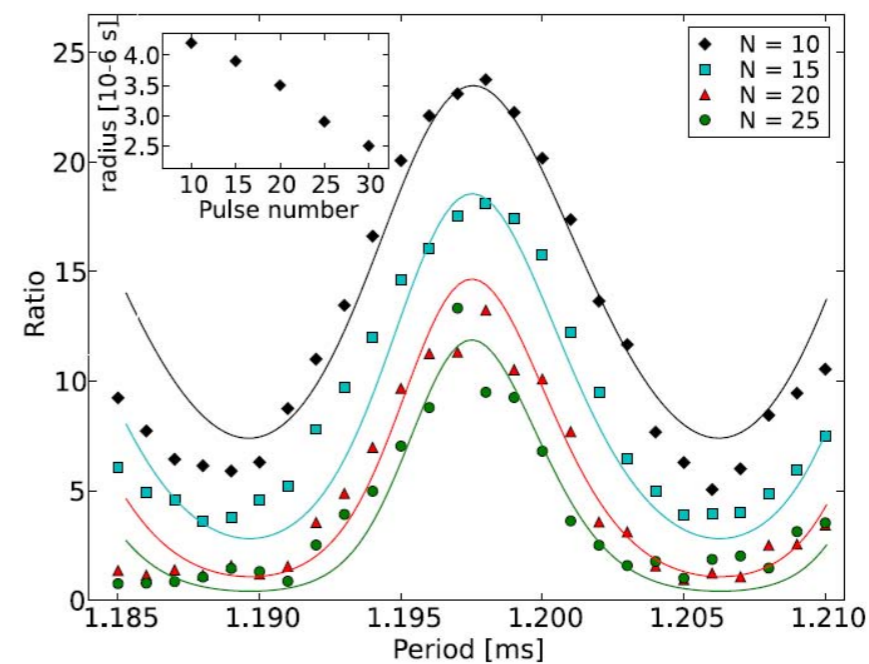

⇒ Measures g with 10^{-5} precision

✓ First pulse is the 1st beam splitter

⇒ Coherent superposition

⇒ Different speed

⇒ The two components split

✓ second pulse : mirror

⇒ redirect wavepackets

✓ Last $\pi/2$ pulse when wavepackets recombine

⇒ output depends on phase difference

□ The phase depends on the center of mass position of the atomic WP :

$$\Phi(t_i) = kx(t_i) + \Phi_0$$

$$\Delta\Phi = \phi_1 - 2\phi_2 + \phi_3$$

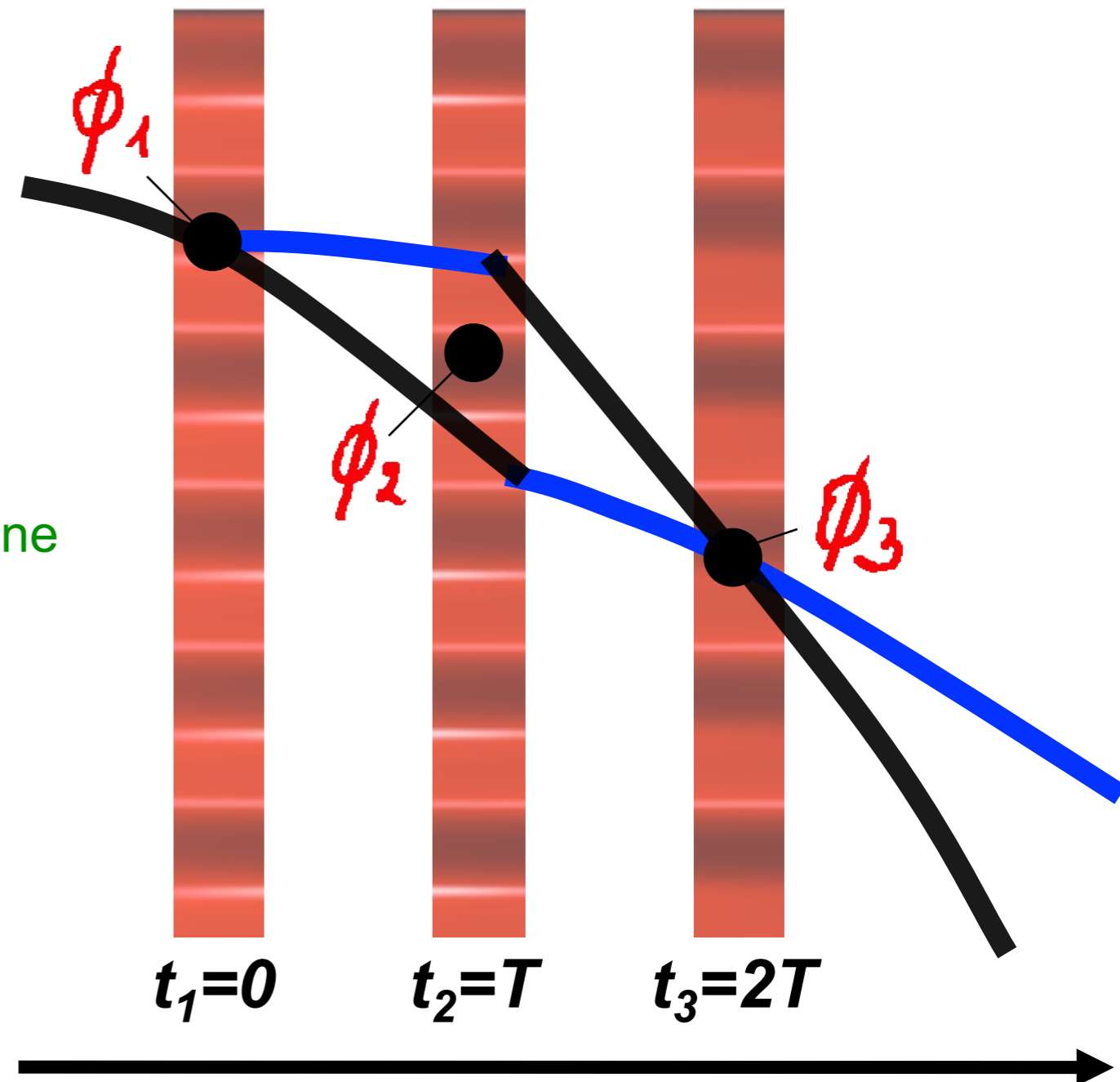



- Interference fringes : $N_{\text{at}} \sim \cos(2\pi a T^2 / \lambda + \Phi)$

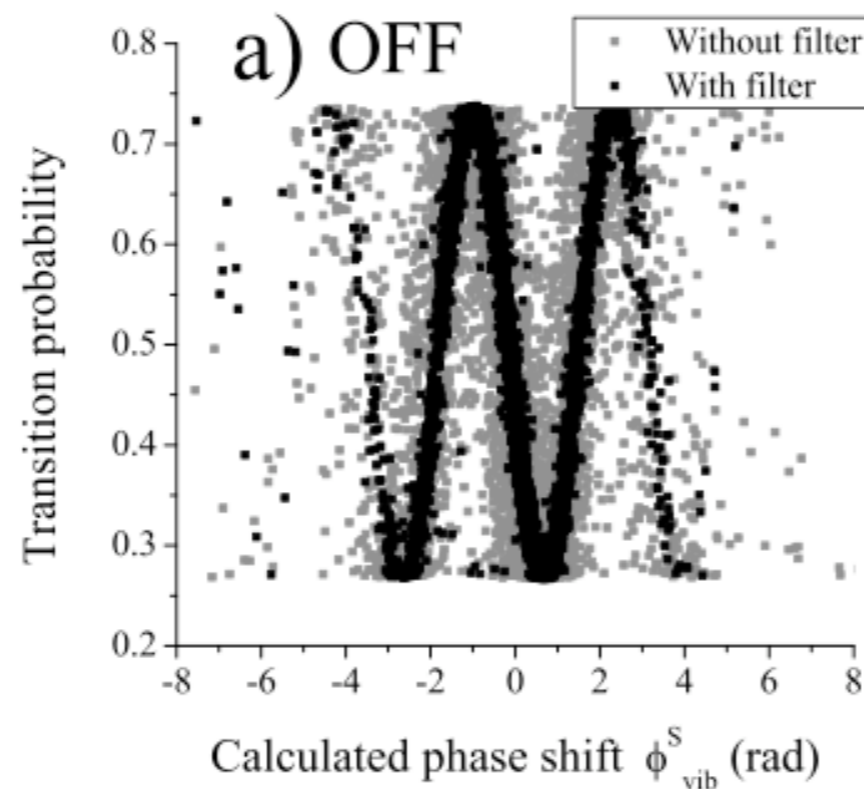

- Extract acceleration from interference signal

$$\Delta a_{\text{min}} = \frac{a}{\sqrt{N}} \Big|_{\Delta \phi_{\text{acc}} = 1 \text{ rad}} \equiv \frac{1}{R T^2 \sqrt{N}}$$

⇒ $T=100$ ms : measures g with 10^{-9} precision and accuracy

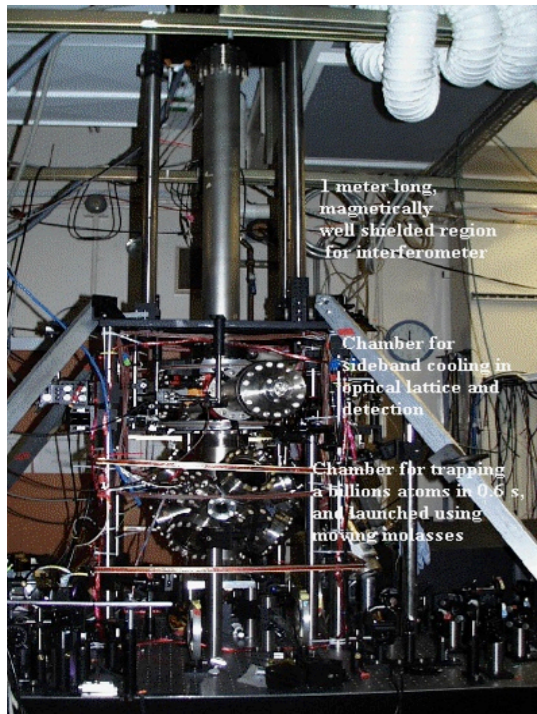

Monitoring of local gravity using $T = 400$ ms fringes

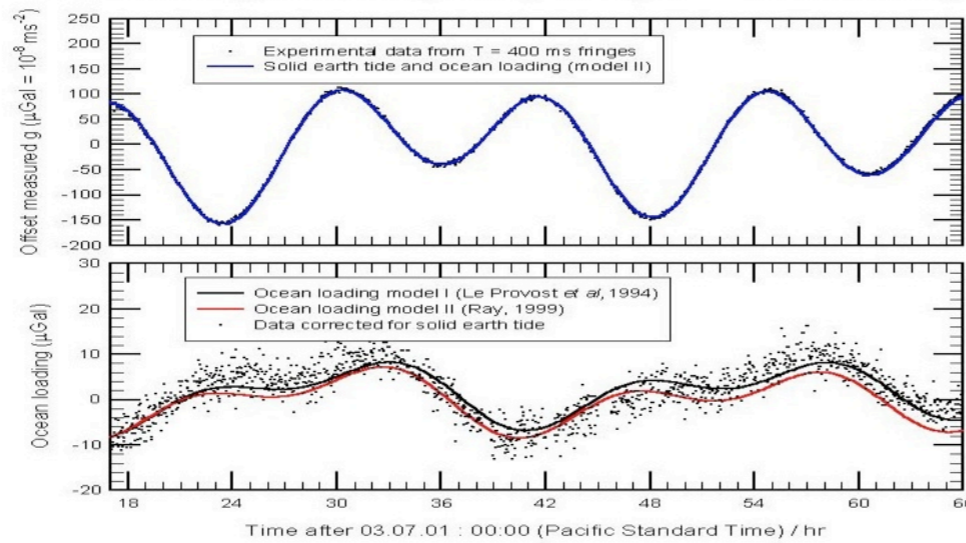

✓ In laboratories, atom gravimeters beat the best commercial gravimeters

- ⇒ Seismic wave detections
- ⇒ Gravity monitoring
- ⇒ Watt balance : quantum definition of the kilogram

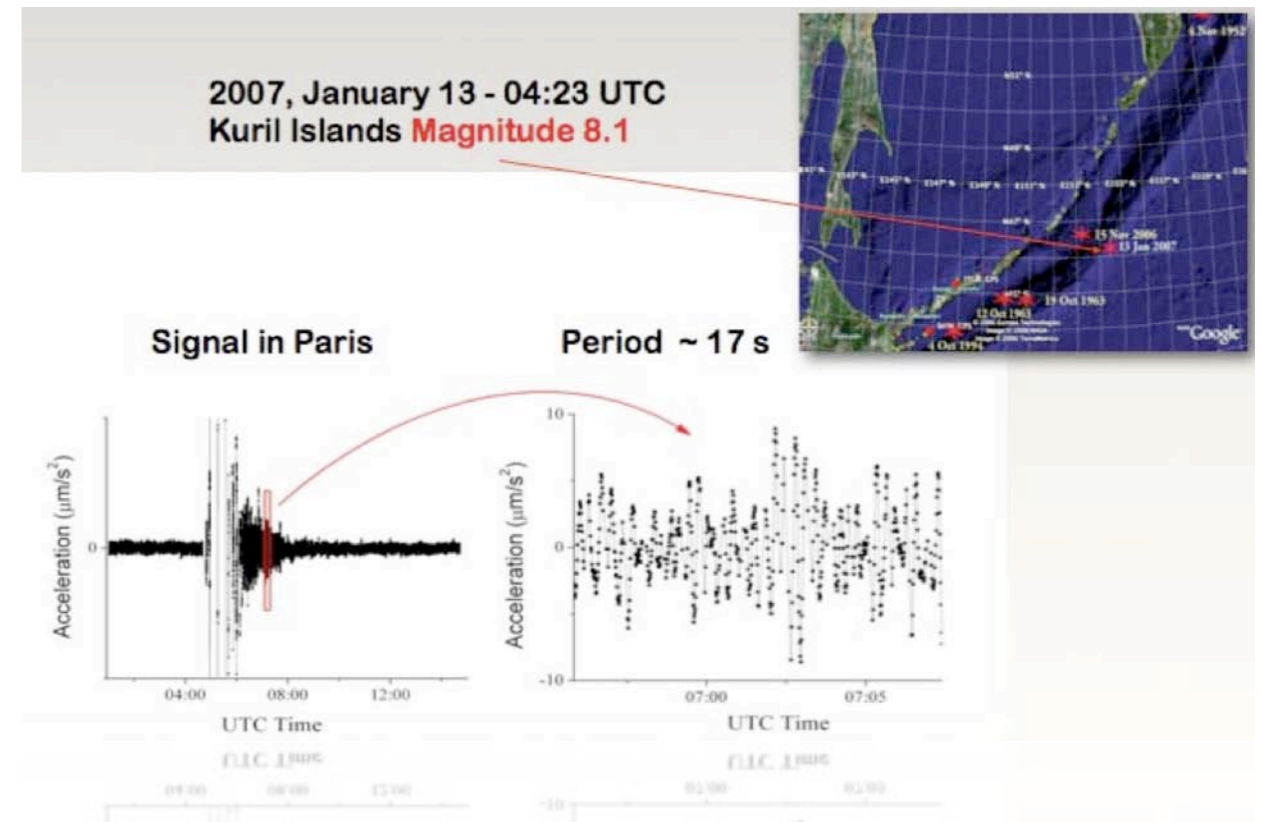
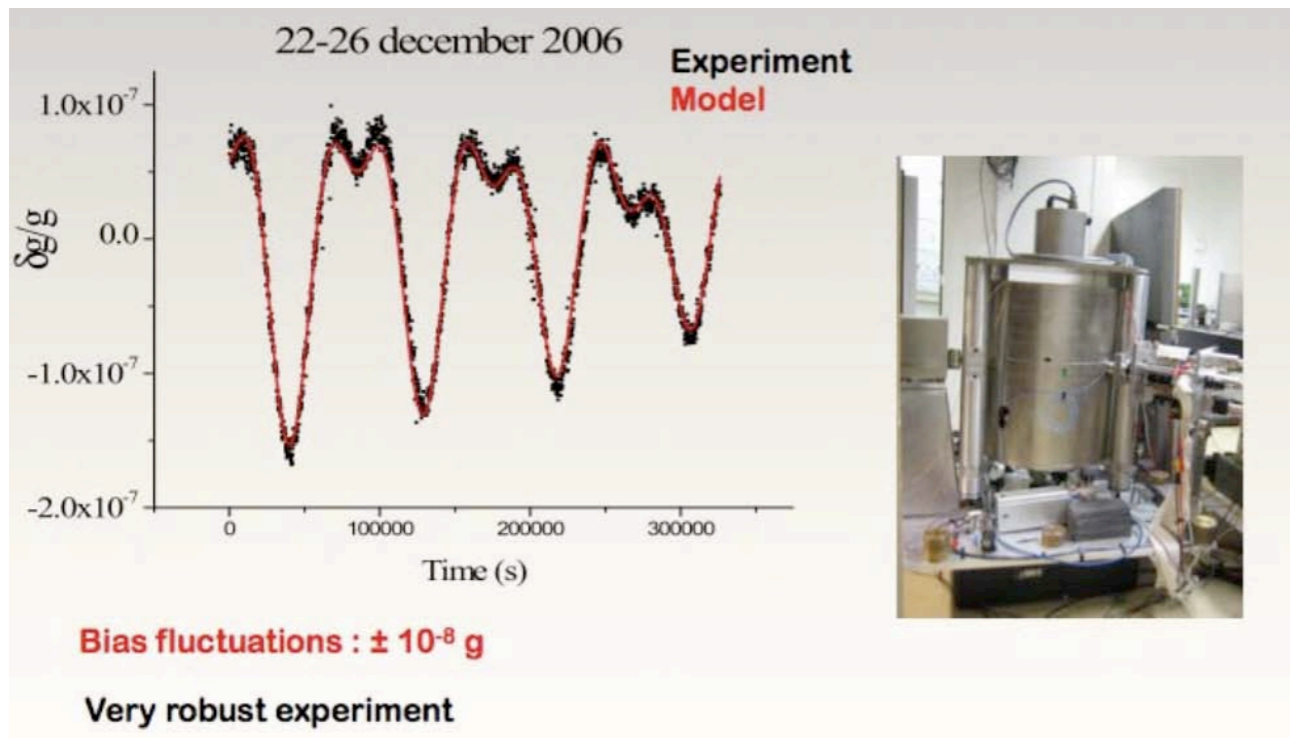

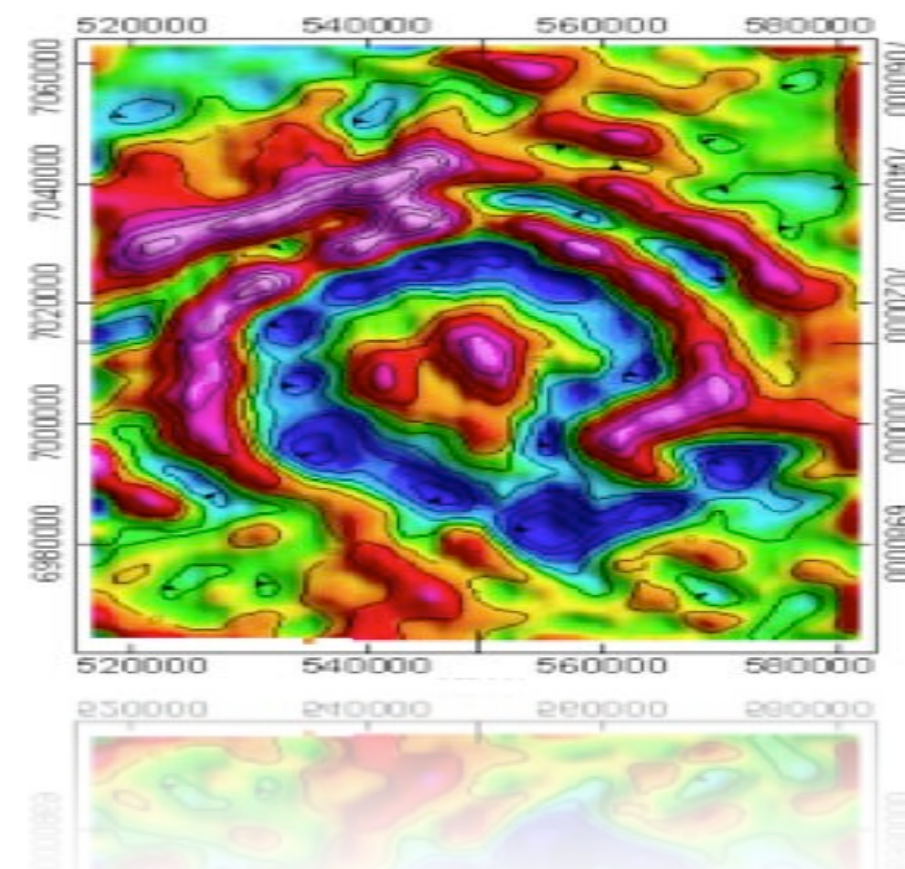
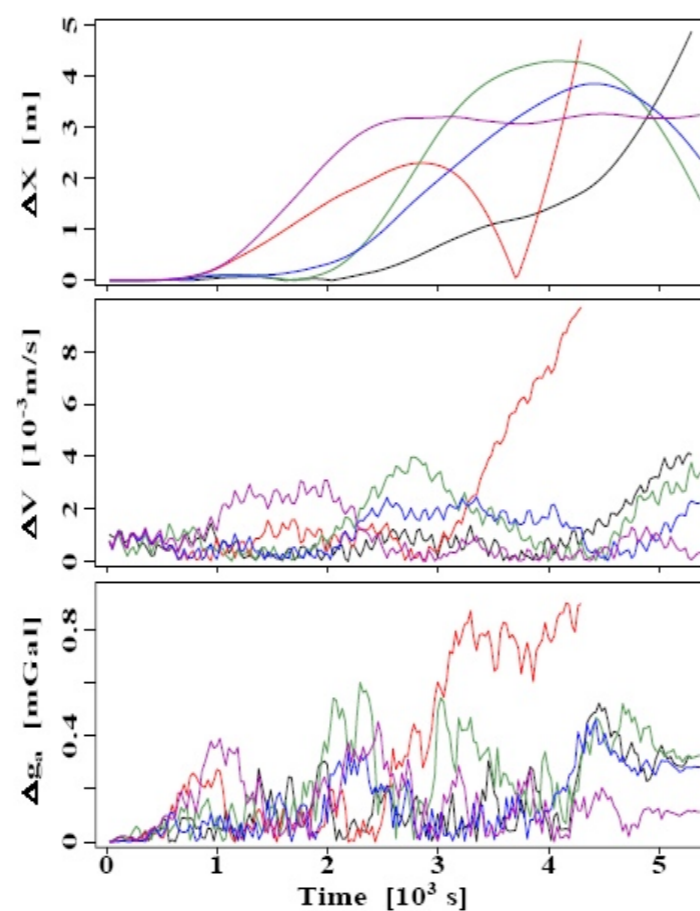
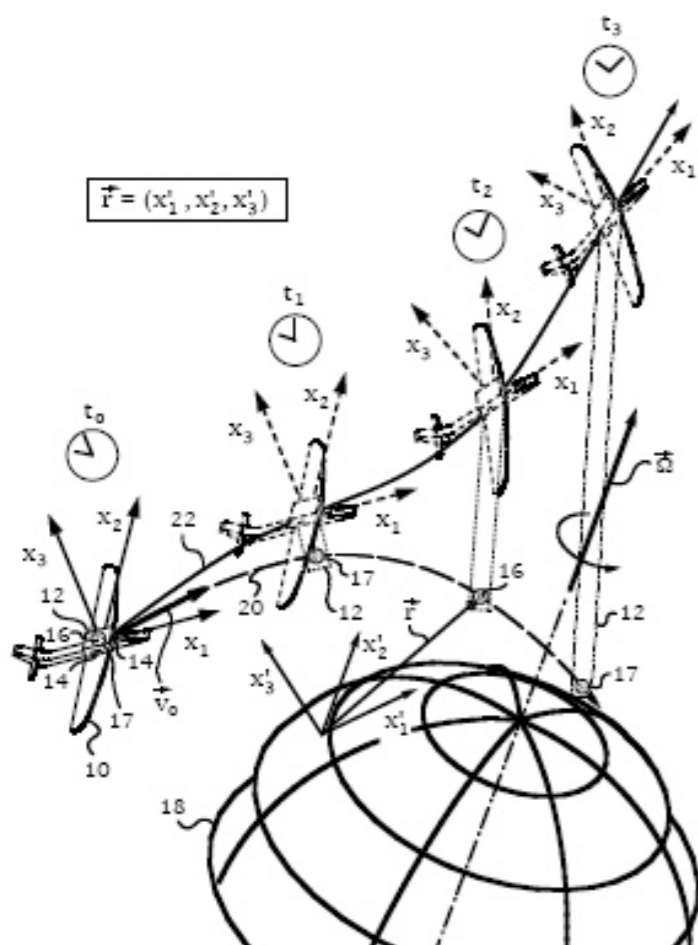

Density difference between water and oil : 0.8. 100 m³ of oil @ 100 m depth = 1 ng anomaly

Simulated navigation solutions.

5 m/hr system drift demonstrated.

Gravitational waves are radiated by objects whose motion involves acceleration, provided that the motion is not perfectly spherically symmetric

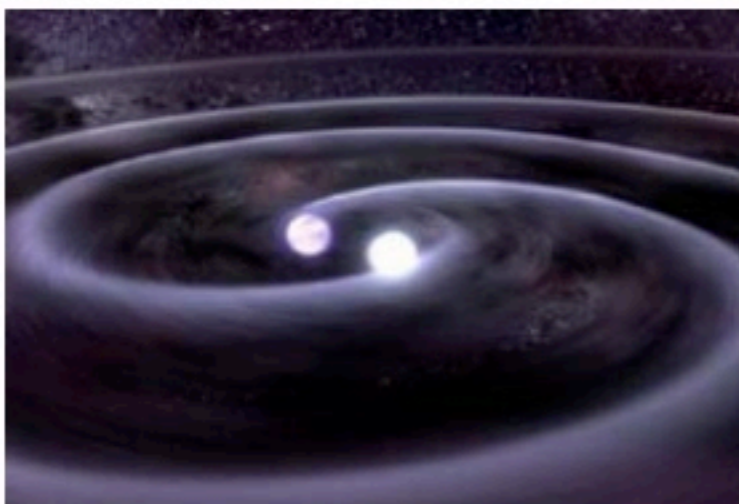

Interesting astrophysical objects (black hole binaries, white dwarf binaries) are sources of gravitational radiation in 0.01 – 10 Hz frequency band.

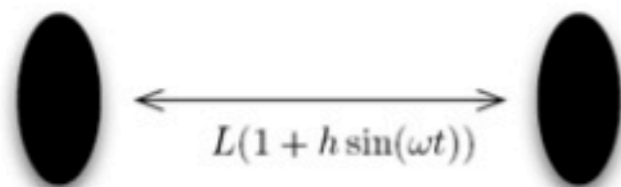

Distance between objects modulates by hL , where h is strain of wave and L is their average separation.

For the Earth-Sun system, we can find:
$$h_+ = -\frac{1}{R} \frac{G^2}{c^4} \frac{4m_1 m_2}{r} = -\frac{1}{R} 1.7 \times 10^{-10} \text{ meters.}$$

For $R \approx 1$ light-year, typical amplitudes will be $h \approx 10^{-26}$.

Differential accelerometer configuration
for gravity wave detection.

Atoms provide inertially decoupled
references (analogous to mirrors in
LIGO)

Gravity wave phase shift through
propagation of optical fields.

Gravity wave induced phase shift:

$$\Delta\phi \sim h L \sin^2(\omega T/2)$$

h is strain, L is separation, T is pulse
separation time, ω is frequency of
wave

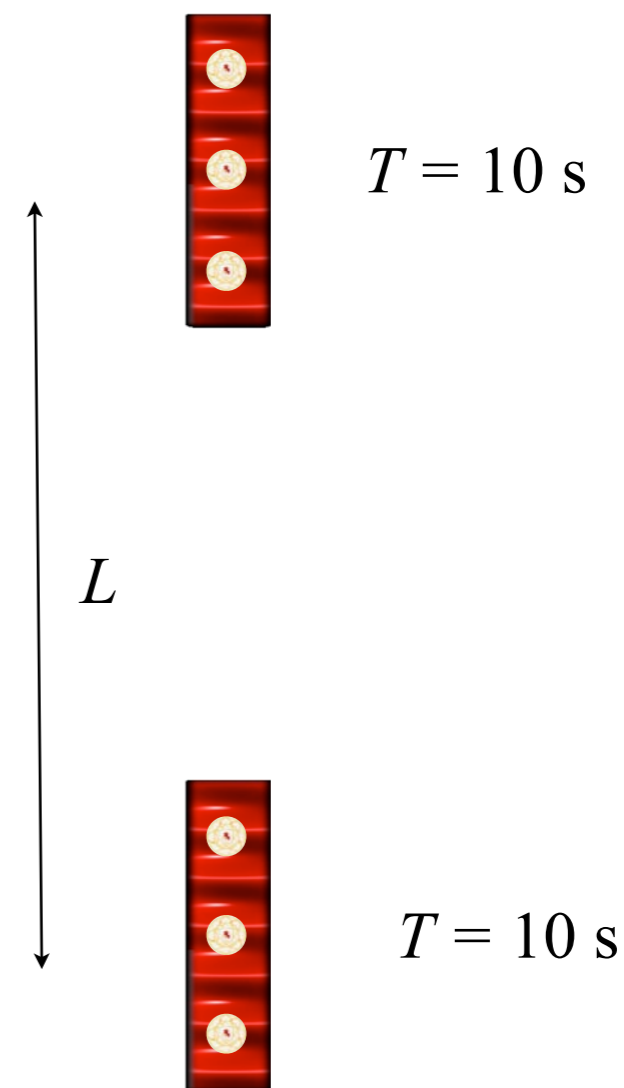

⇒ AI sensitivity : 10^{-15} m/s²

⇒ 10 km separation : $h = 10^{-19}$

- ✓ Compare the free fall of 2 different atomic species.
- ✓ Atom interferometry : use a precise ruler to get the position in time
- ✓ $\eta = \Delta a/a$ measured at the 10^{-7} level with 2 different isotopes and two different spins, can reach 10^{-15} on ground with specific apparatus.

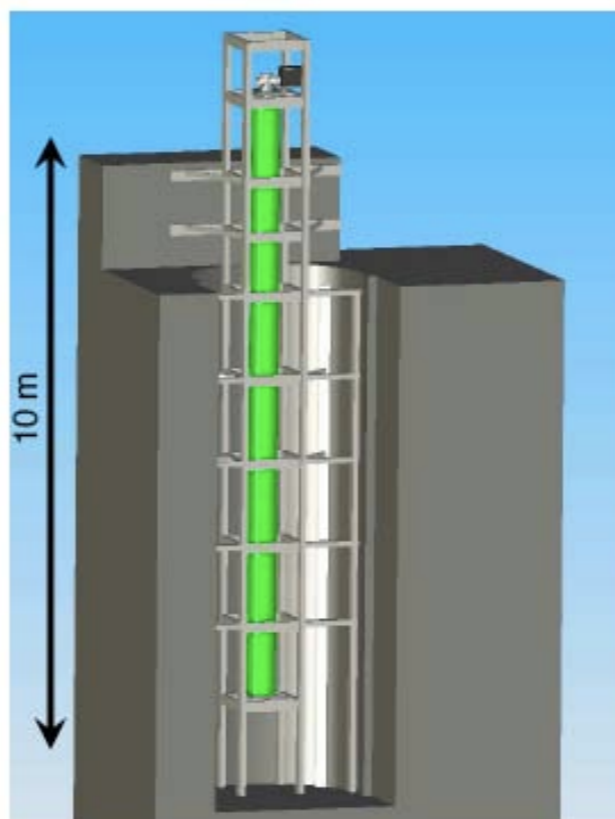
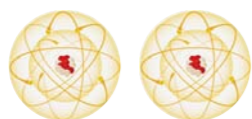

10 m atom drop tower.

Drop capsule
boundary conditions

Laser

Electronics

Vacuum

Computer

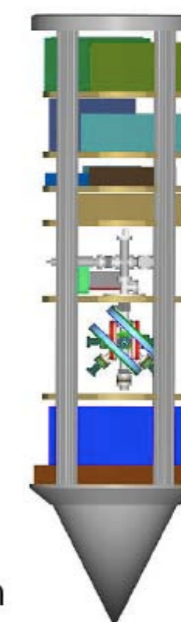

$h = 1.73 \text{ m}$

$d = 0.6 \text{ m}$

av. Power < 280 W

Weight < 274 kg

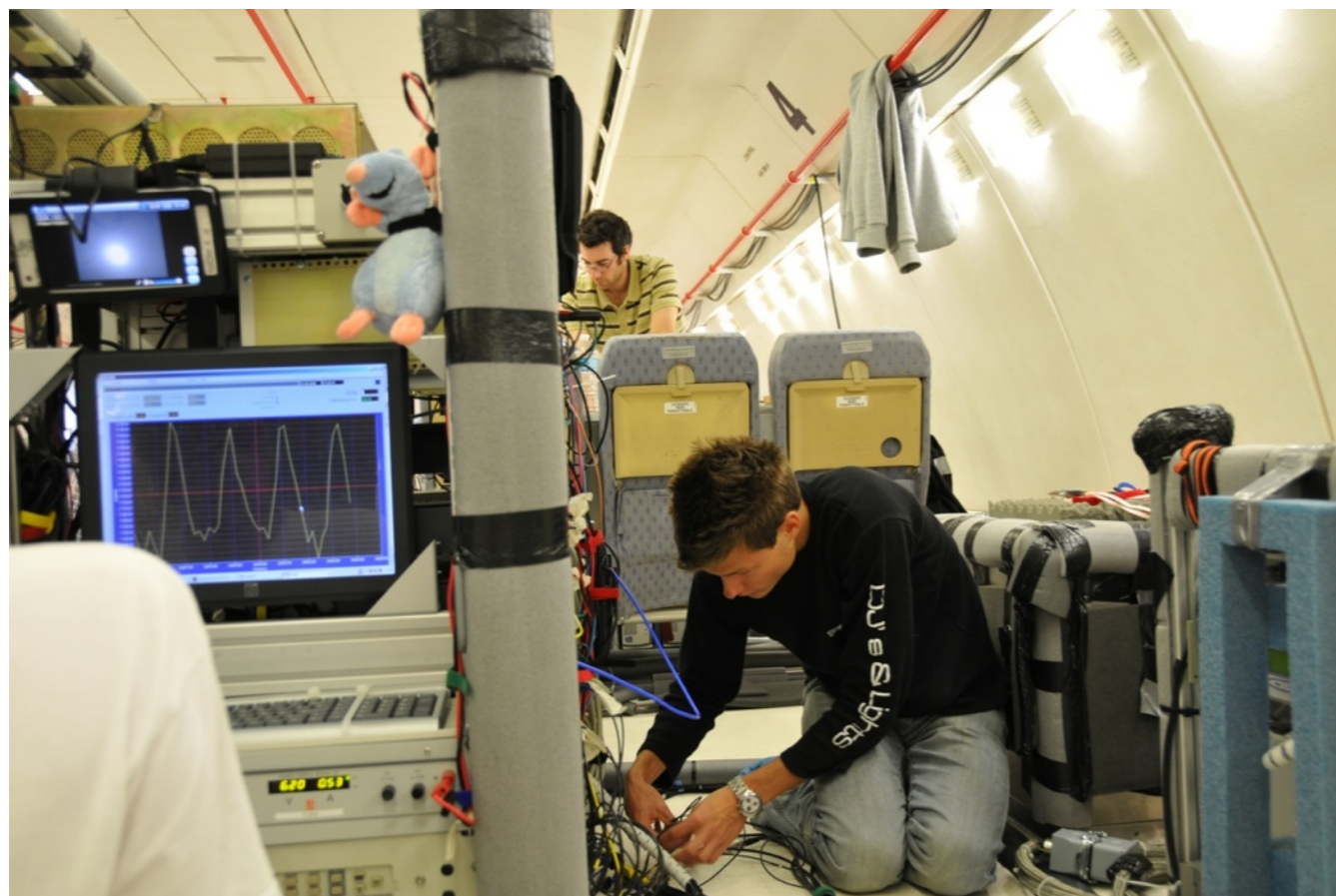

⇒ Compact experiment operating in the 0-g airbus of Novespace (CNES)

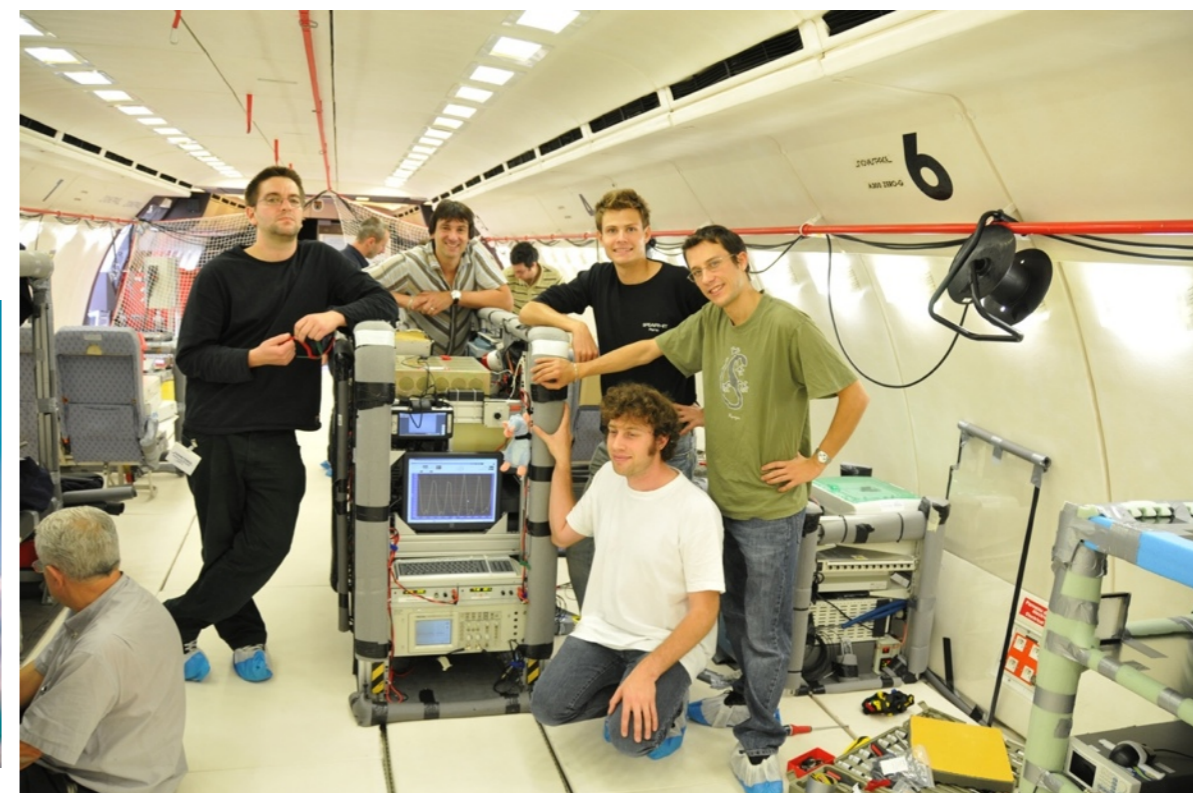

PARABOLIC FLIGHT

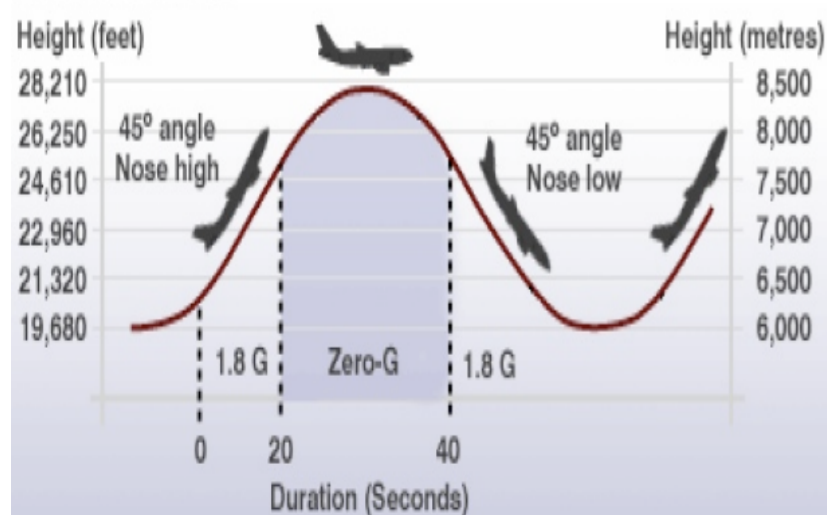



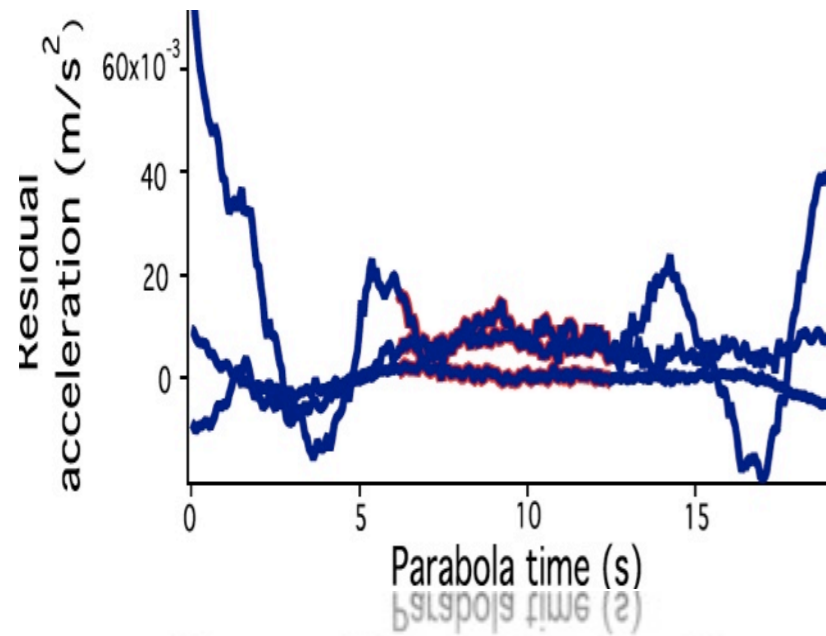

- ⇒ Vibrations correspond to 100 fringes shift.
- ⇒ No measurement possible ?

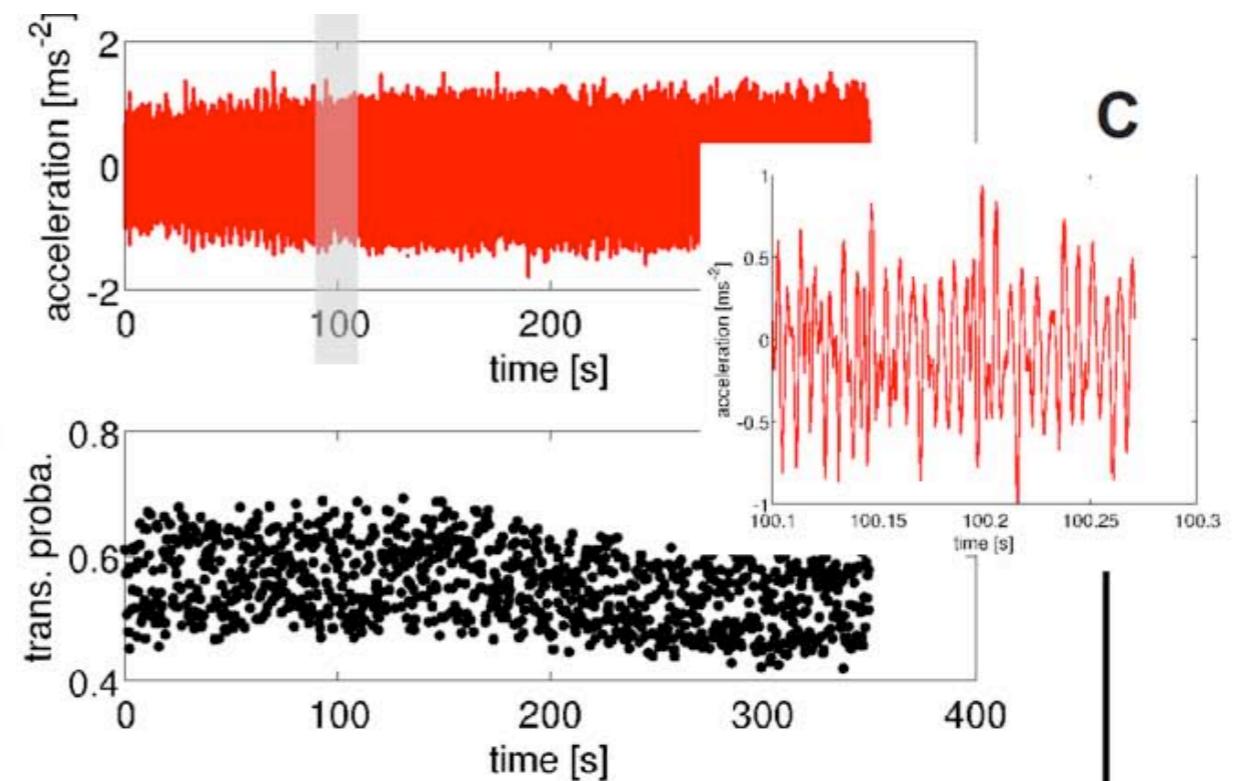
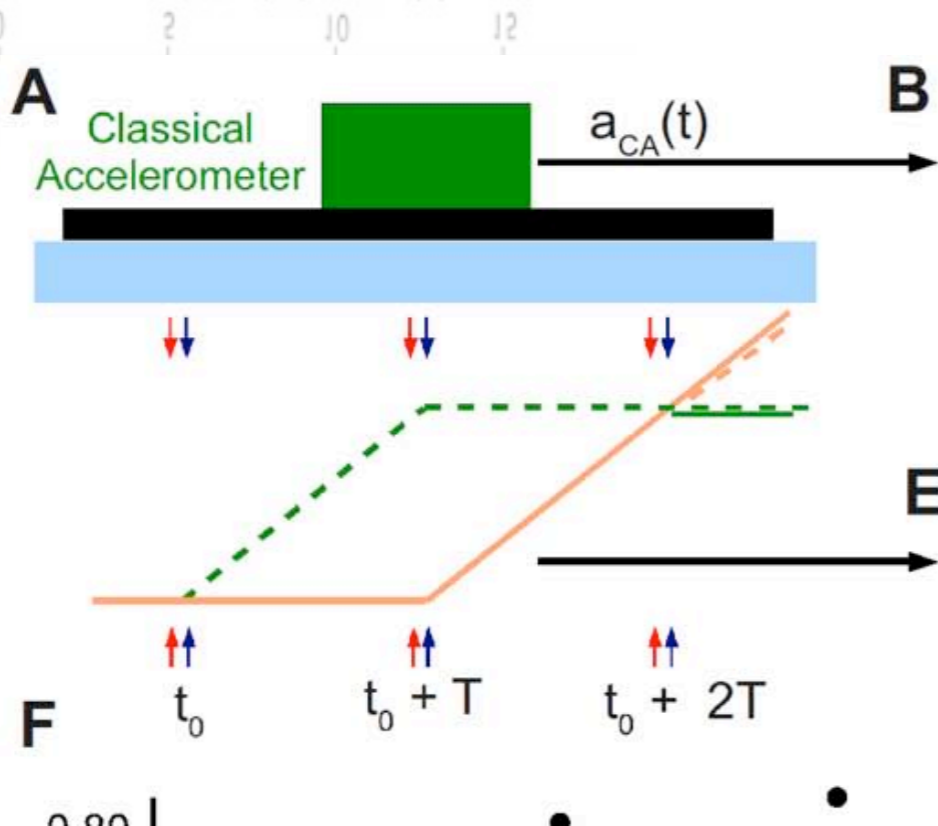

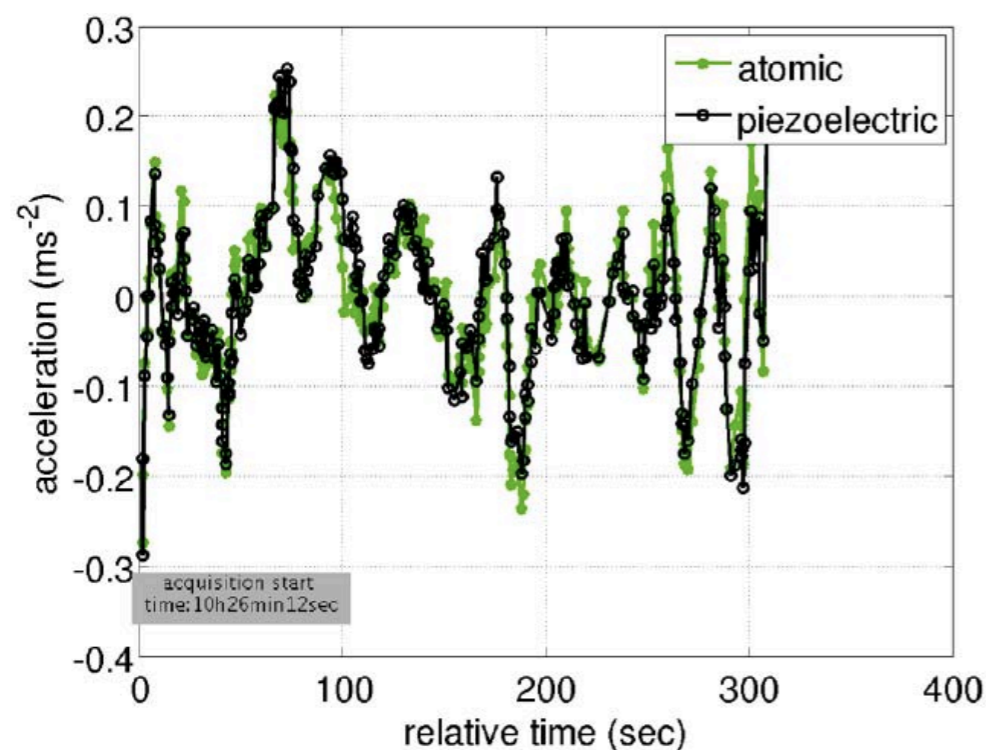
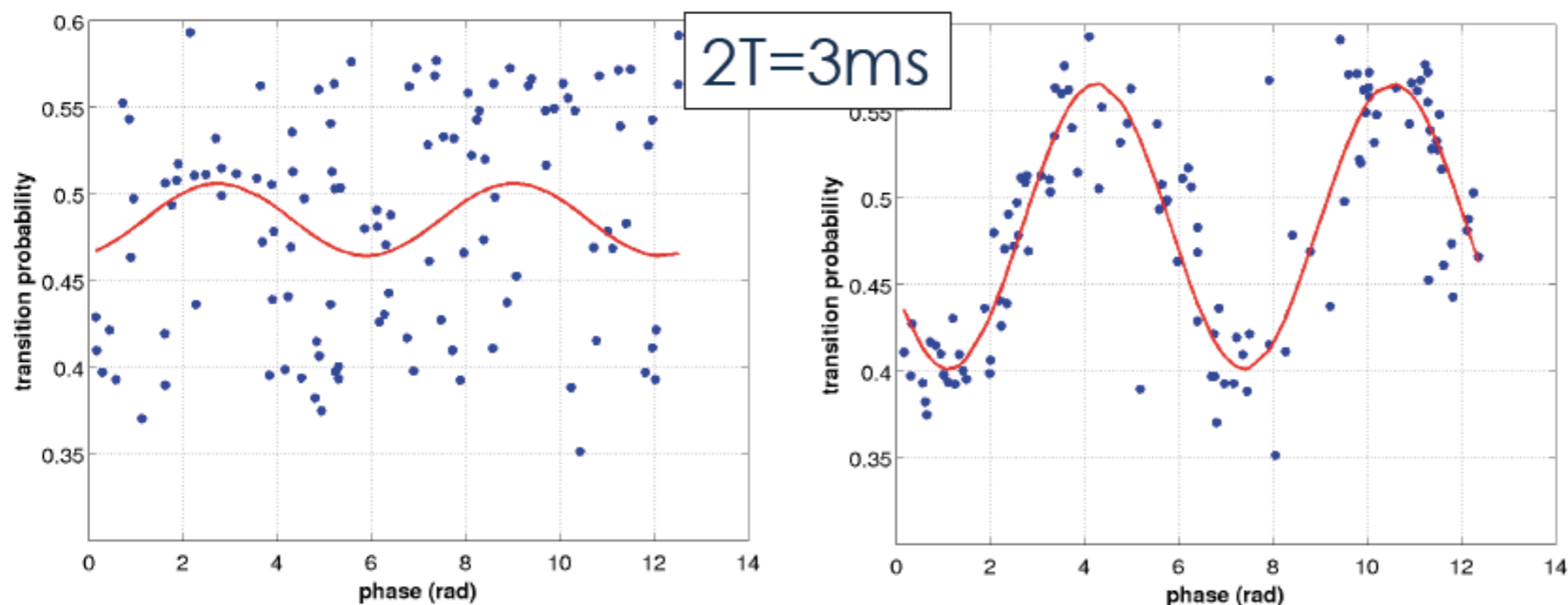

- ⇒ Correlation with low perf classical accelerometer allows to reconstruct the fringes
- ⇒ 30 μg of resolution, 1000 times smaller than the noise.

STERN, G., et al., EUROPEAN PHYSICAL JOURNAL D, 2009. 53(3): p. 353-357.

BEC is a coherent matter wave

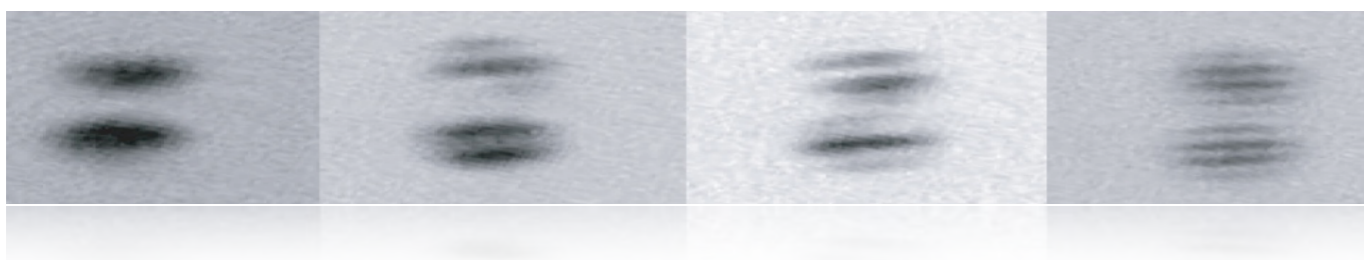

From the light bulb ...

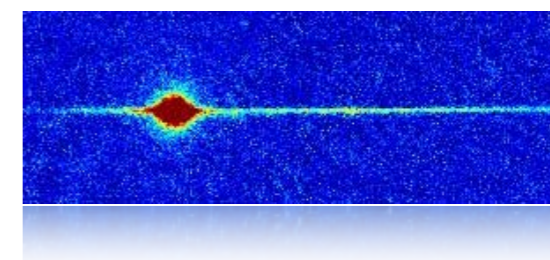

... to the laser

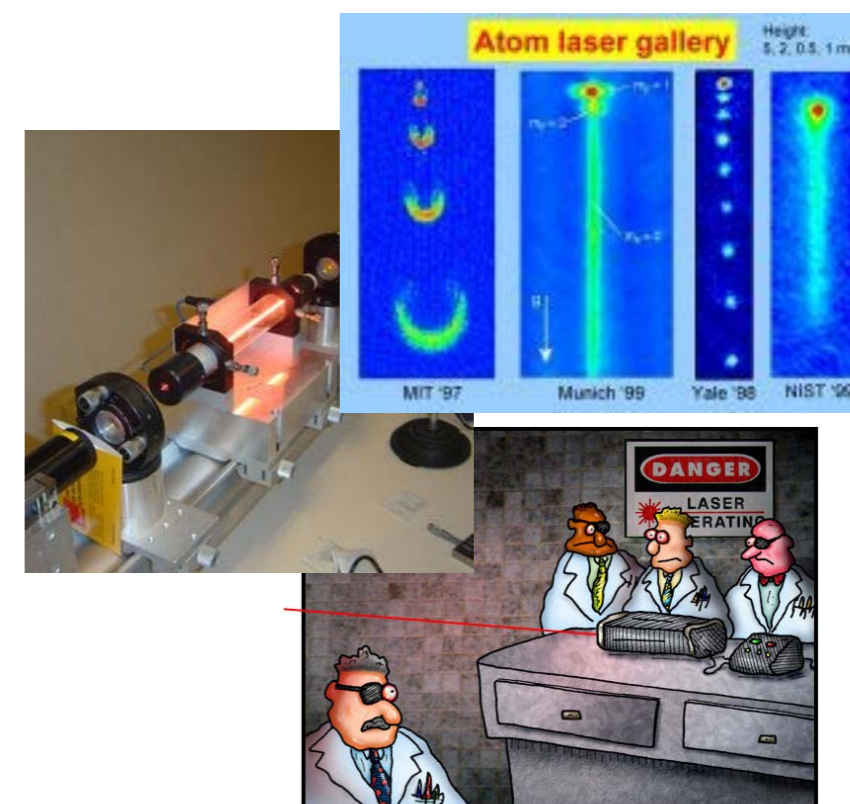
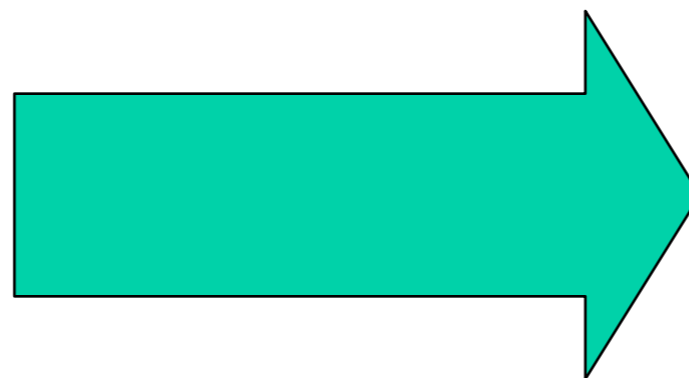

BEC is a coherent matter wave

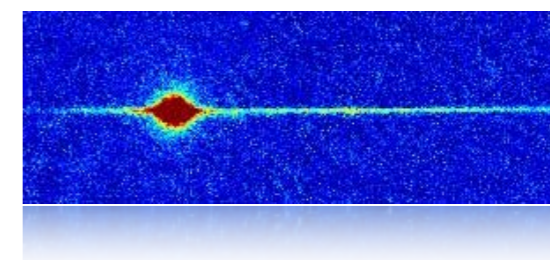
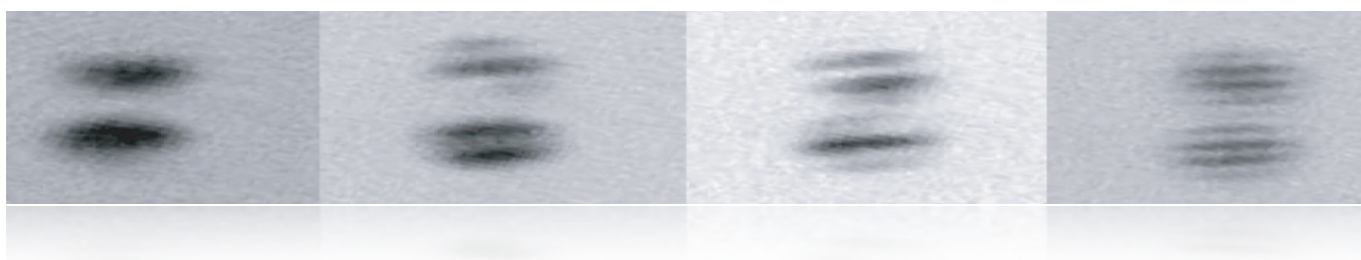

BEC is a macroscopic quantum state where interaction play a important role

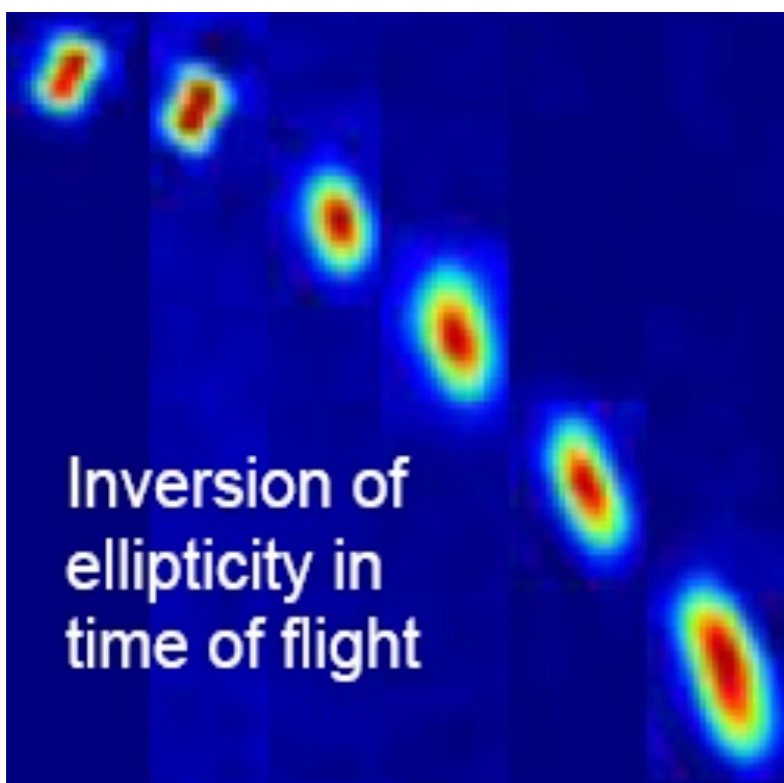

$$i\hbar \frac{\partial \psi}{\partial t} = -\frac{\hbar^2}{2m} \nabla^2 \psi + V\psi + gN|\psi|^2 \psi$$

Propagation follows a non-linear Schrödinger equation (Gross-Pitaevski)

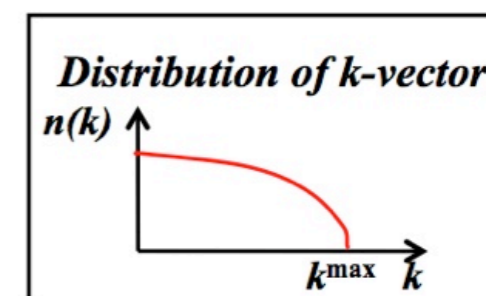
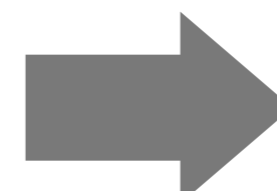
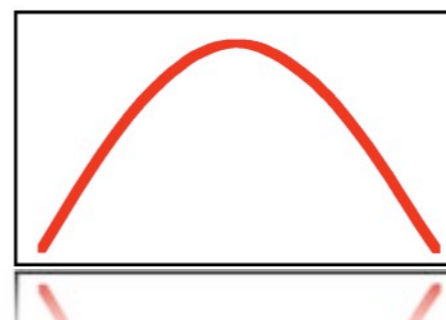

BOUYER -

2010

Superfluidity

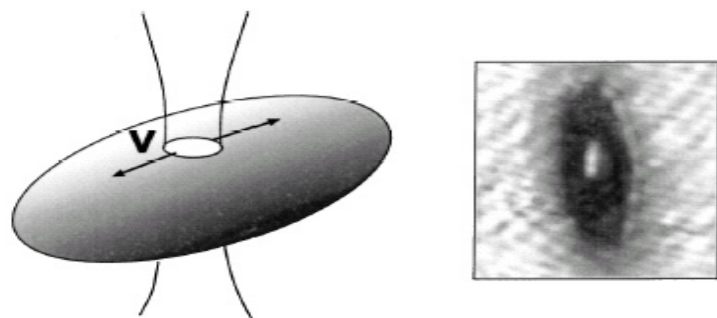

C. Raman et al., PRL. 83, 2502-2505 (1999).

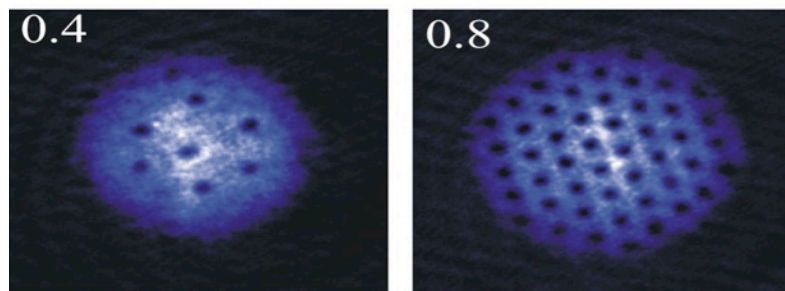

Degenerate mixtures
(bosons, fermions).

Controllable
configurations and
interactions

Mott transition

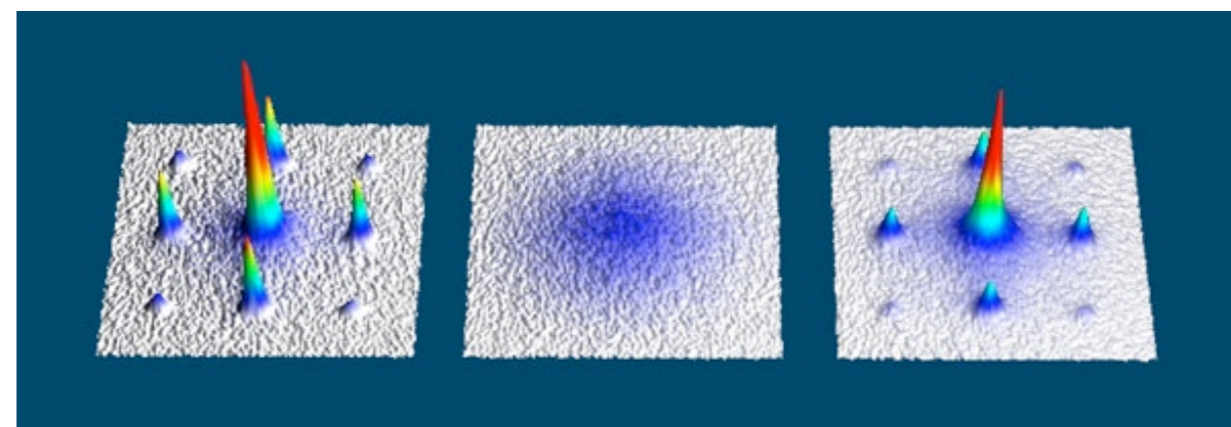

M. Greiner et al.,
Nature 415, 39-44, 2002

BEC-BCS crossover

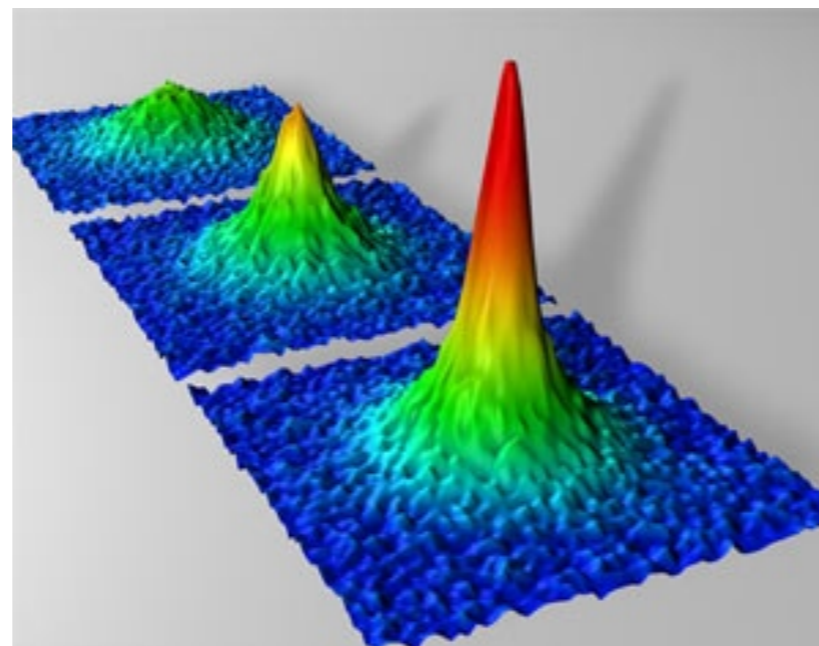

C.A. Regal & D.S. Jin.,
PRL 90, 230404, 2003

«Quantum simulators» : building a controllable quantum system to simulate other quantum systems.

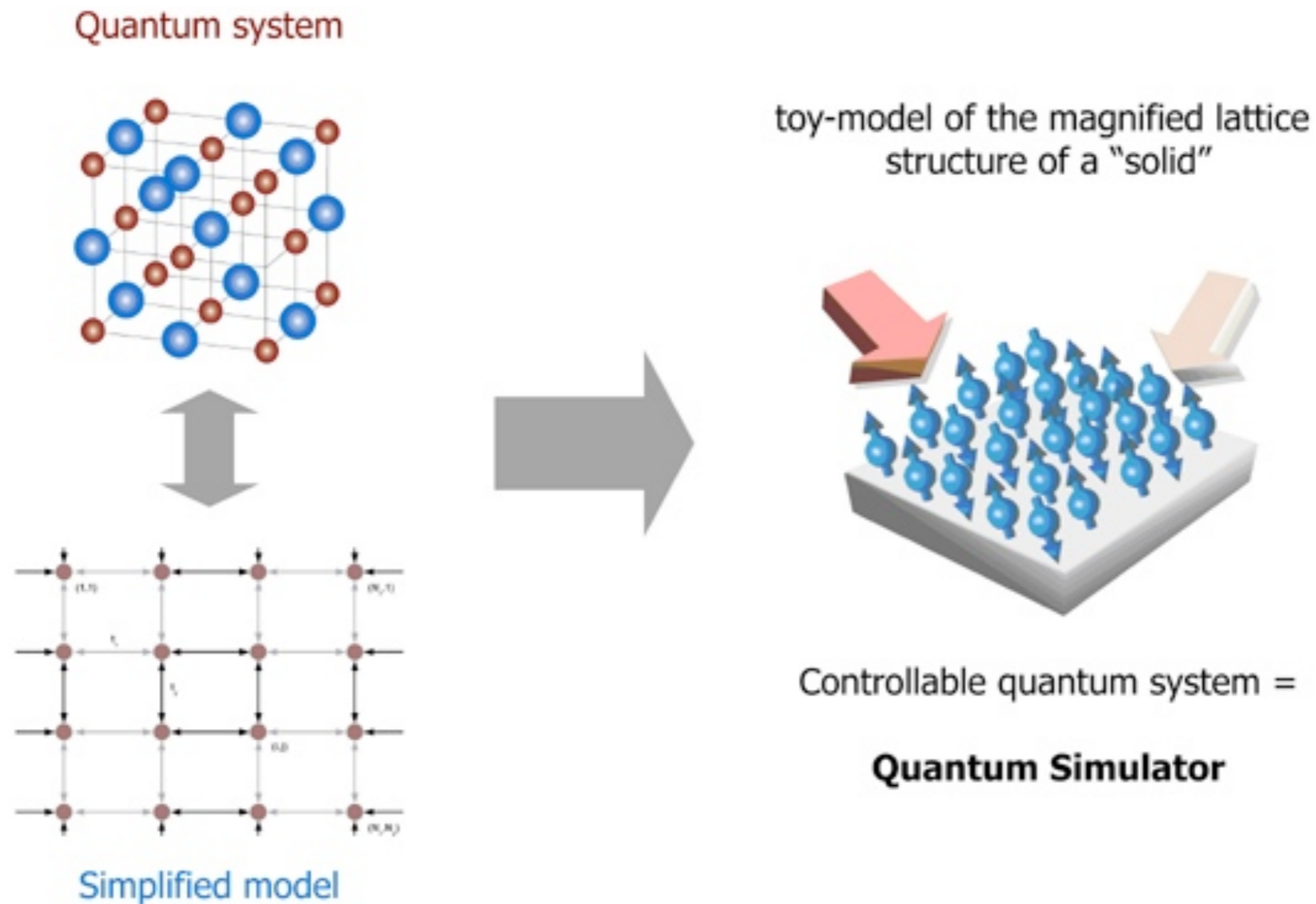

One of the key topics in condensed matter physics is to study the response of electrons to an electromagnetic field

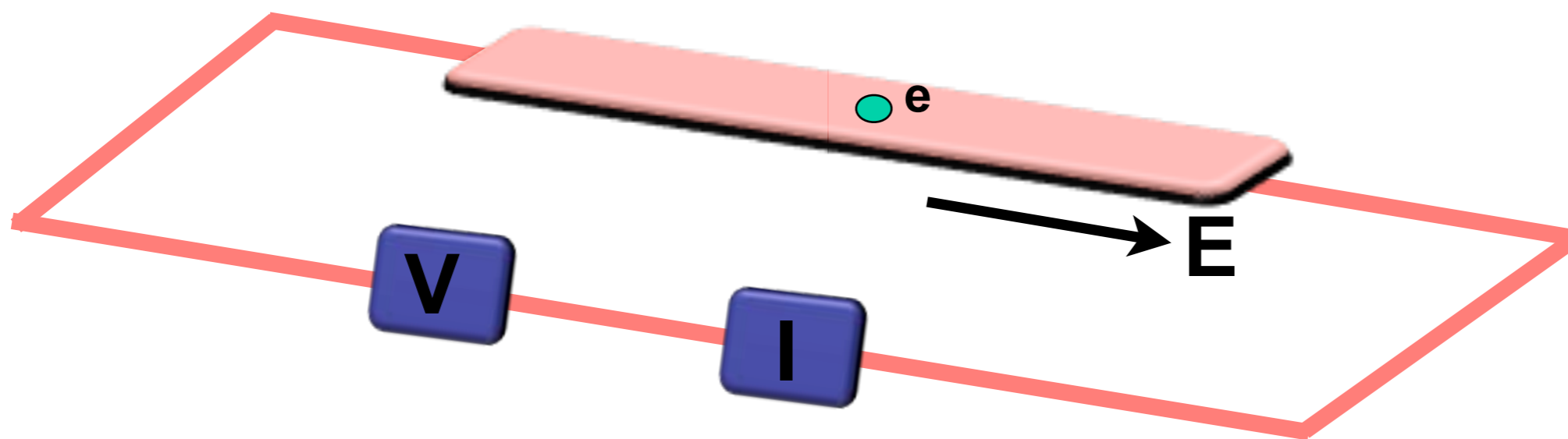

Can we simulate transport and conduction of electrons with atoms.
What is the role of disorder ...

In a perfectly ordered metal

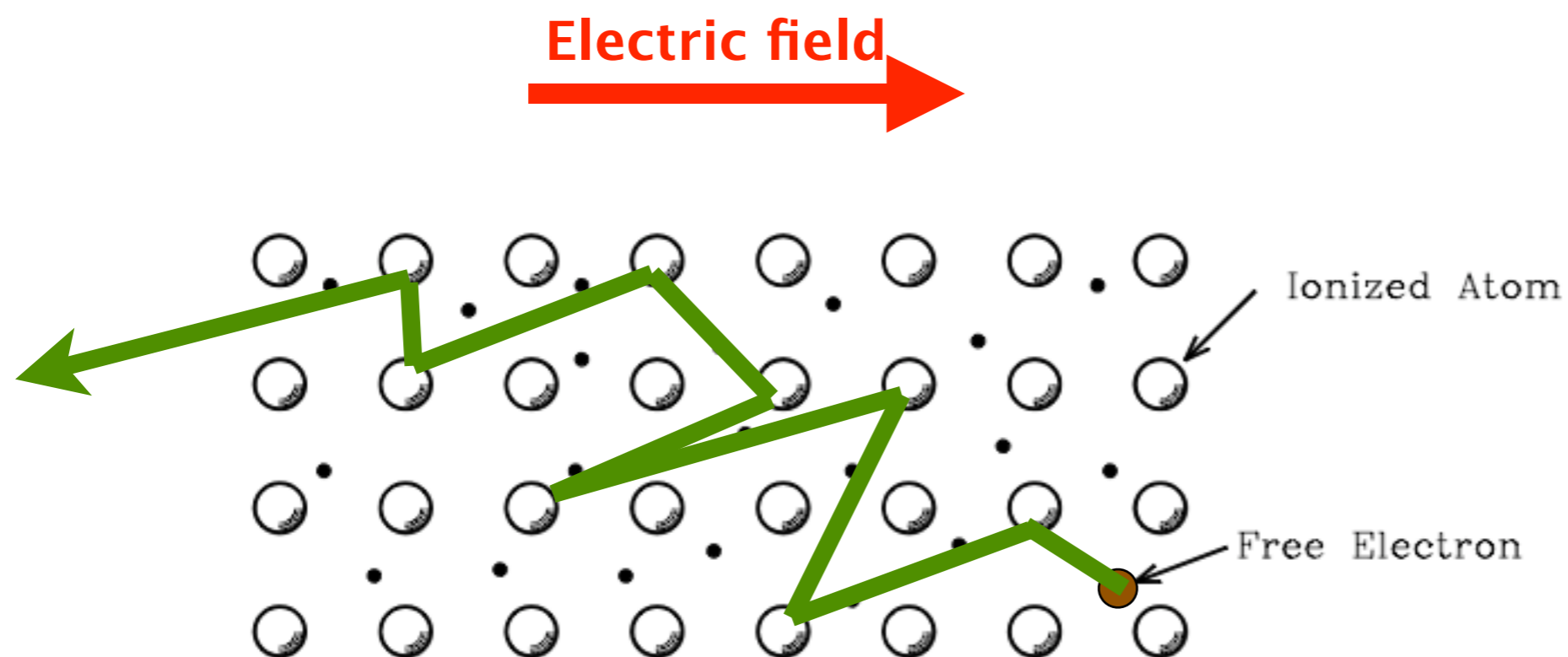

Diffusive transport caused by scattering on lattice defects (Drude model)

In a perfectly ordered metal

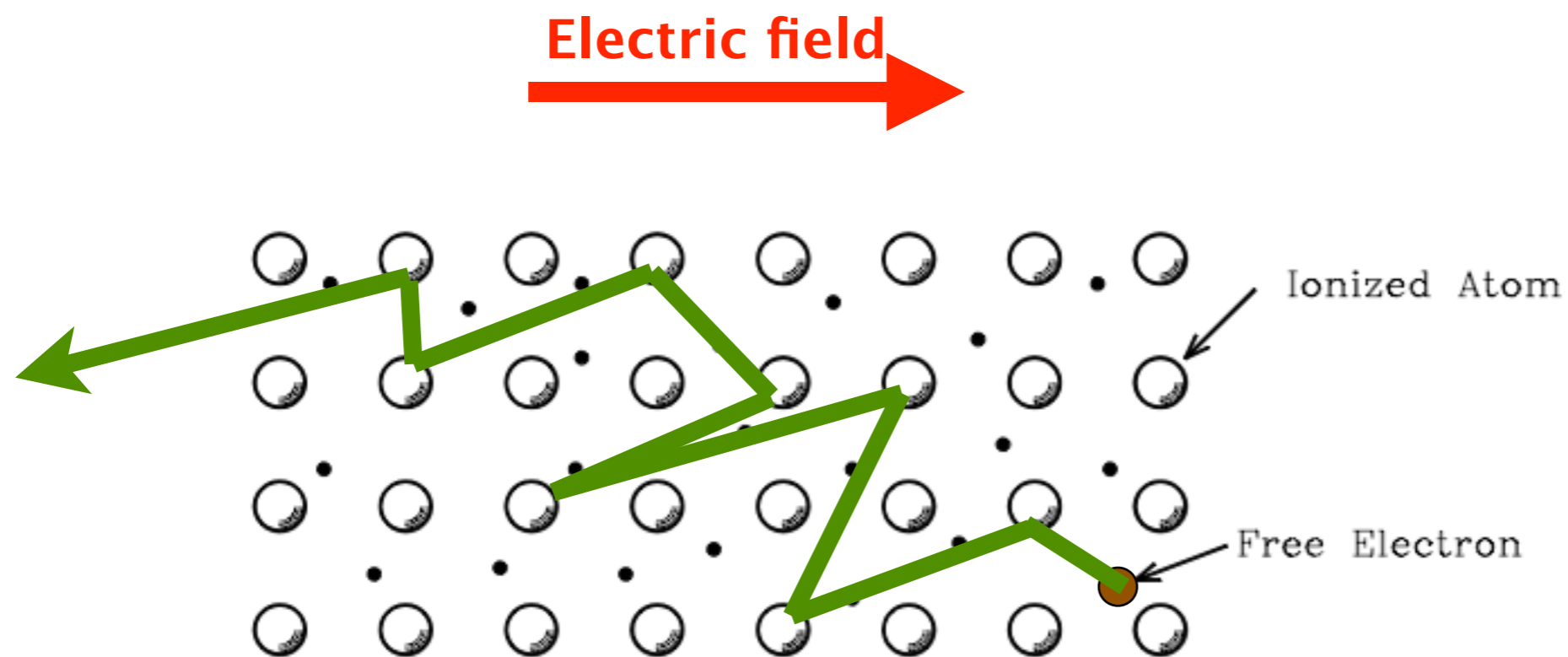

Diffusive transport caused by scattering on lattice defects (Drude model)

Thermal excitation increases diffusion = reduced conductivity

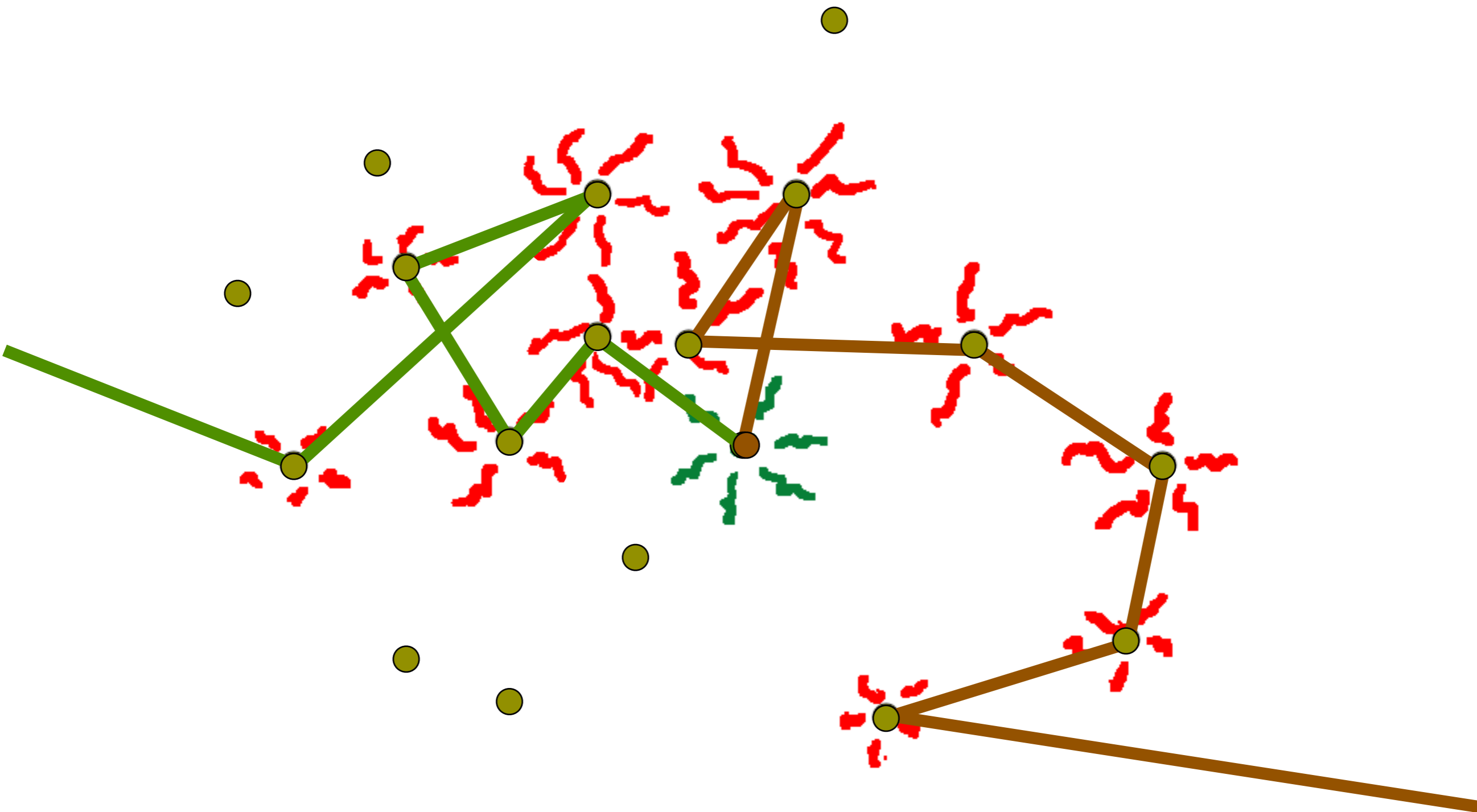

Crossed dipole trap with 1 small beam

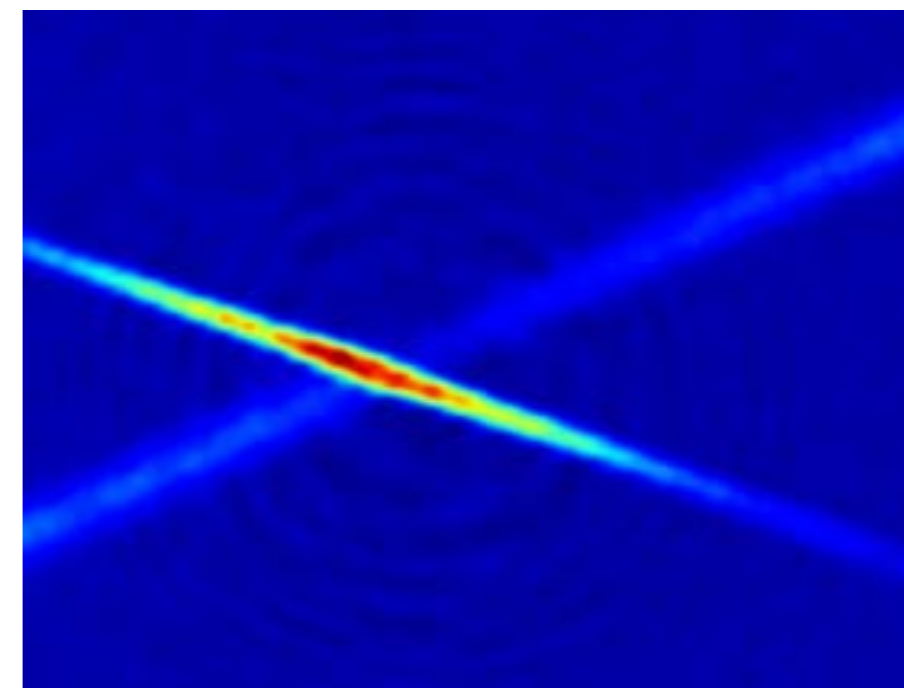
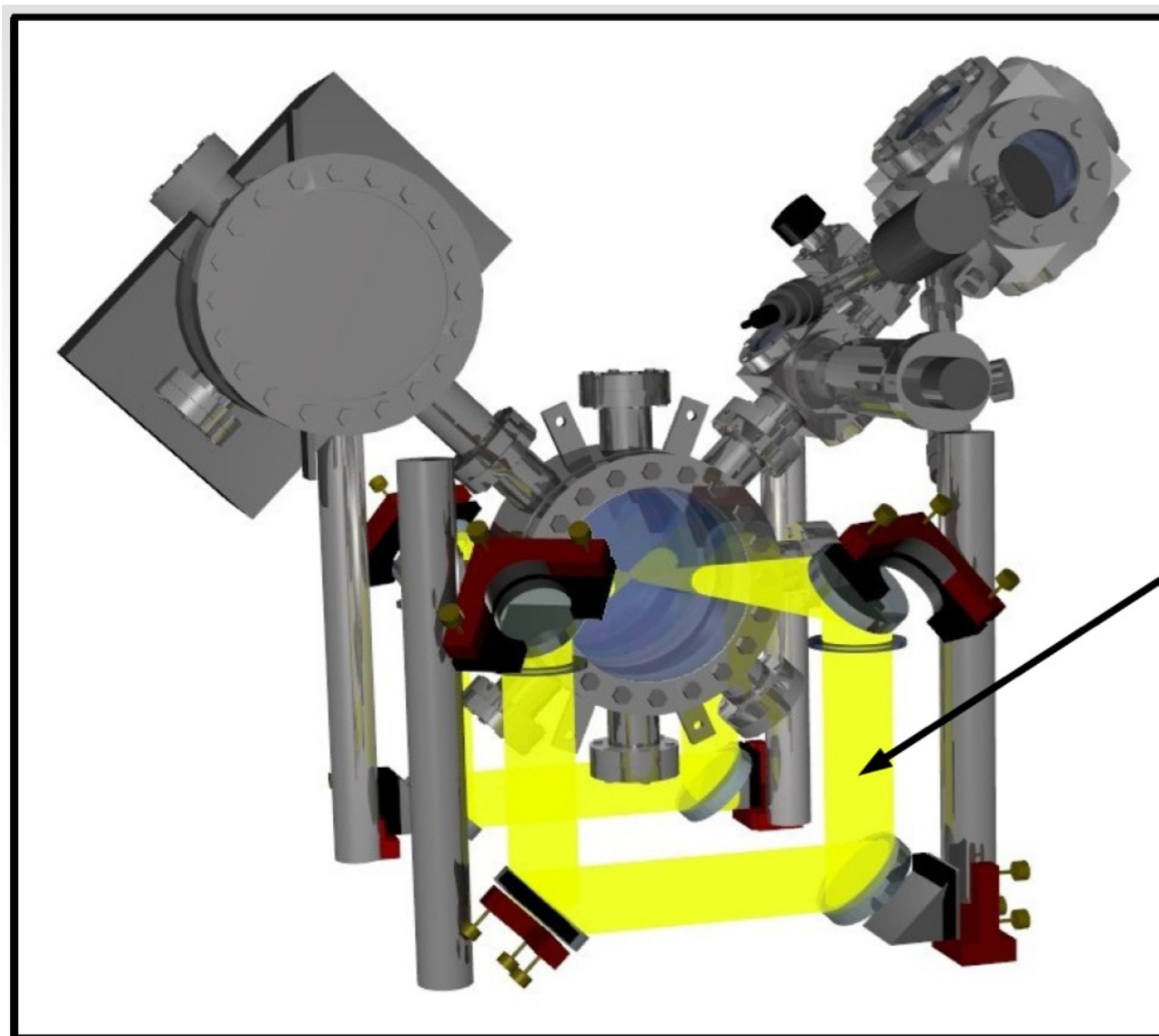

J.-F. Clément, *et al.*, Phys. Rev. A **79**, 061406(R) (2009).

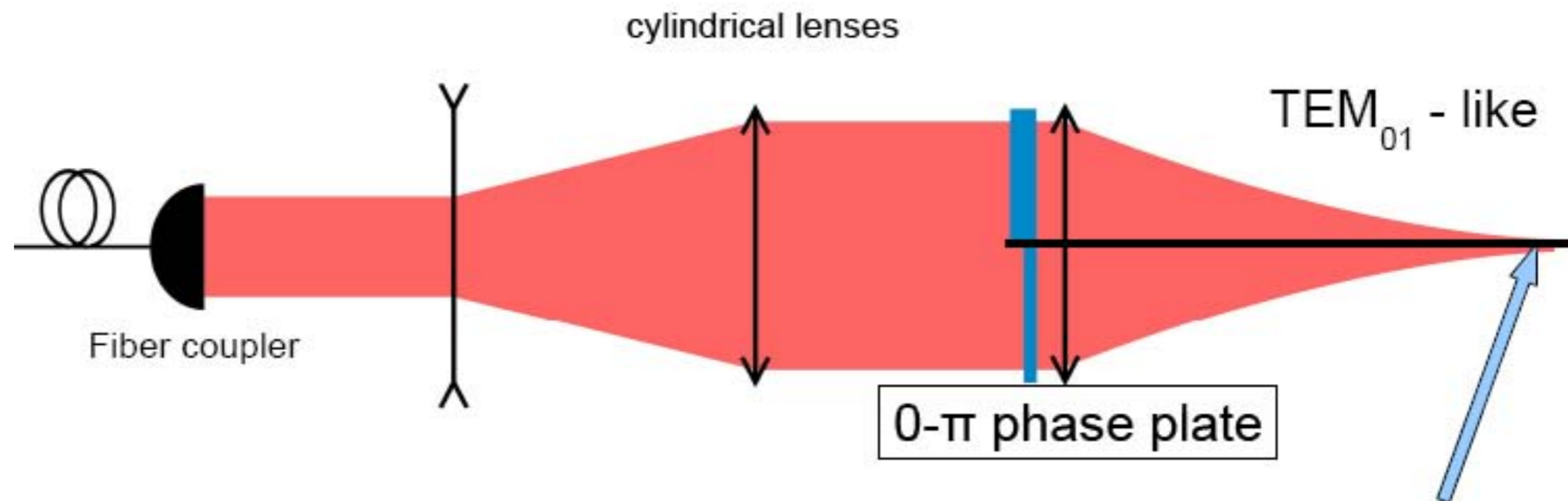

$\lambda = 767 \text{ nm}$ BLUE DETUNED
 $P = 150 \text{ mW}$
 $f_z = 600 \text{ Hz}$

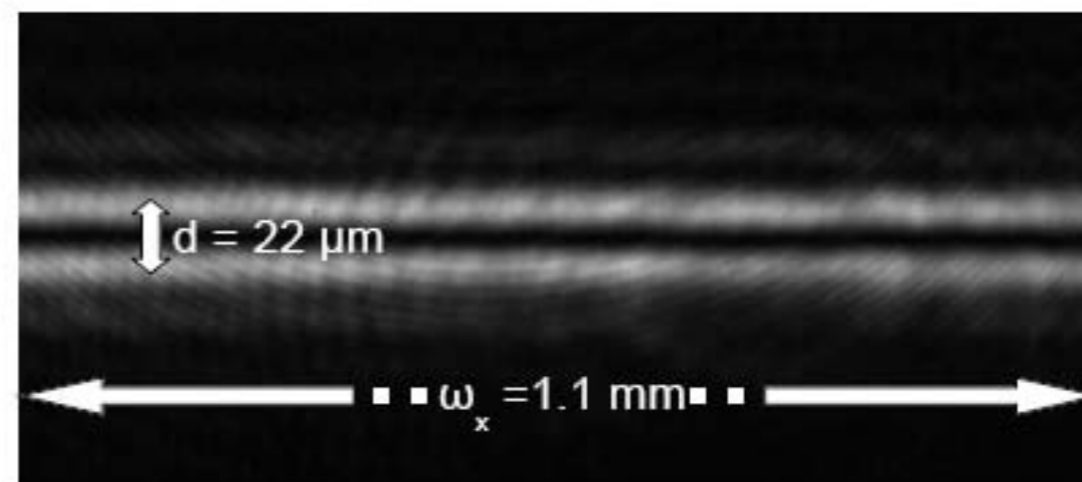
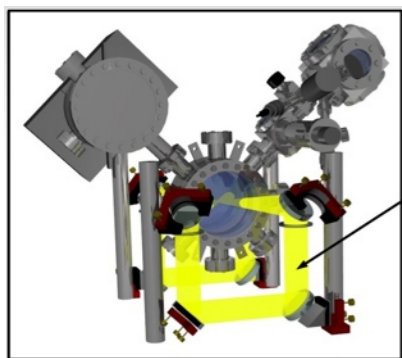

G. Stern et al., arXiv:1003.4761

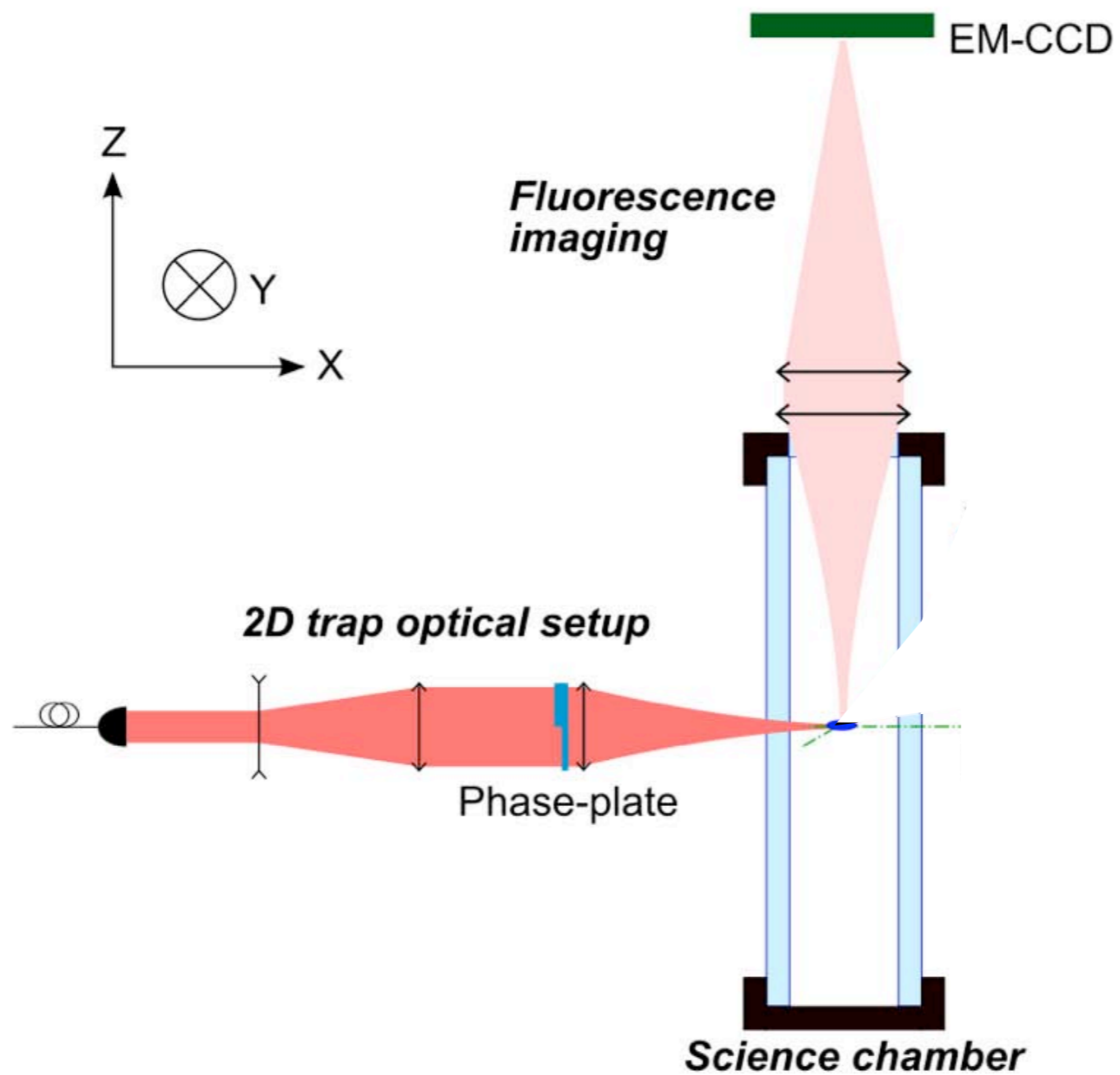

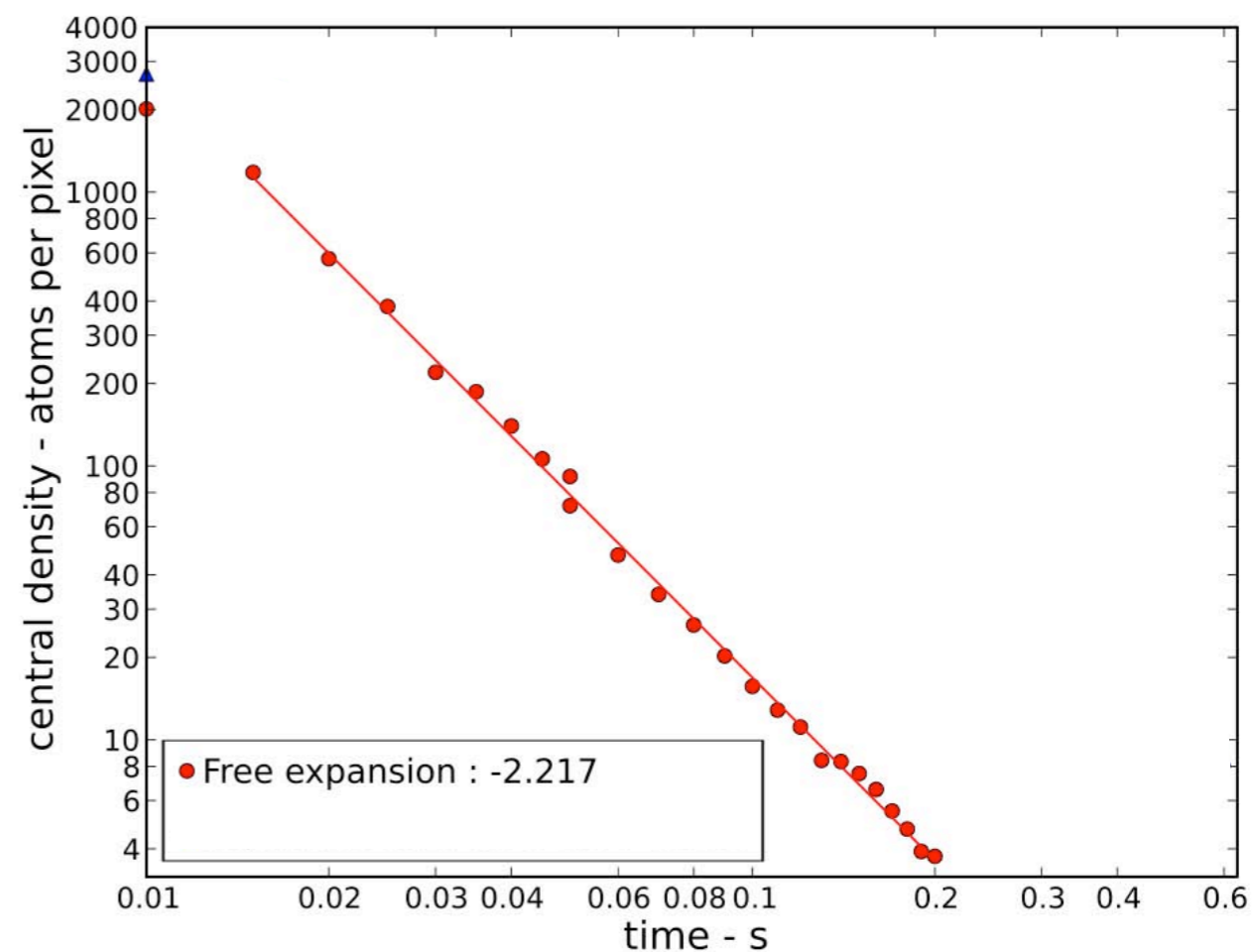
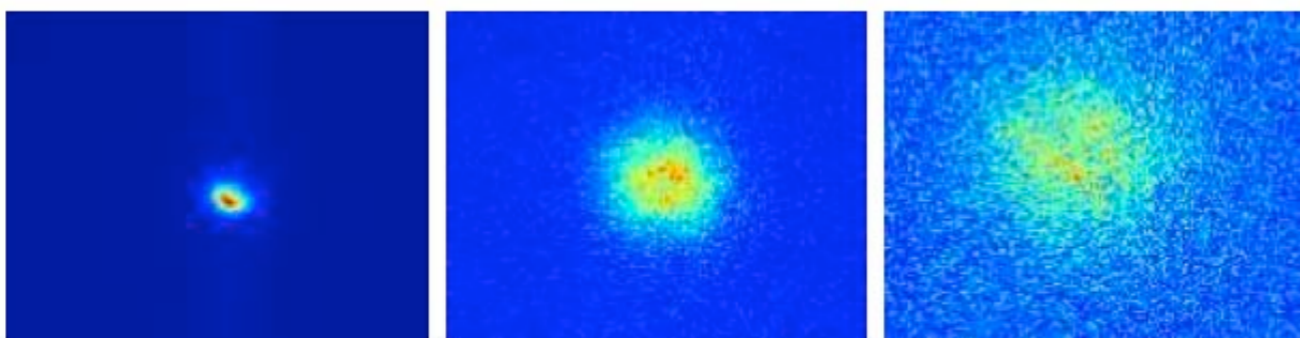

$$r^2(t) = r^2(0) + \frac{k_B T}{M} t^2$$

2D density scales as $1/r^2$

OPTICAL DISORDER FOR ATOMS : SPECKLE PATTERN

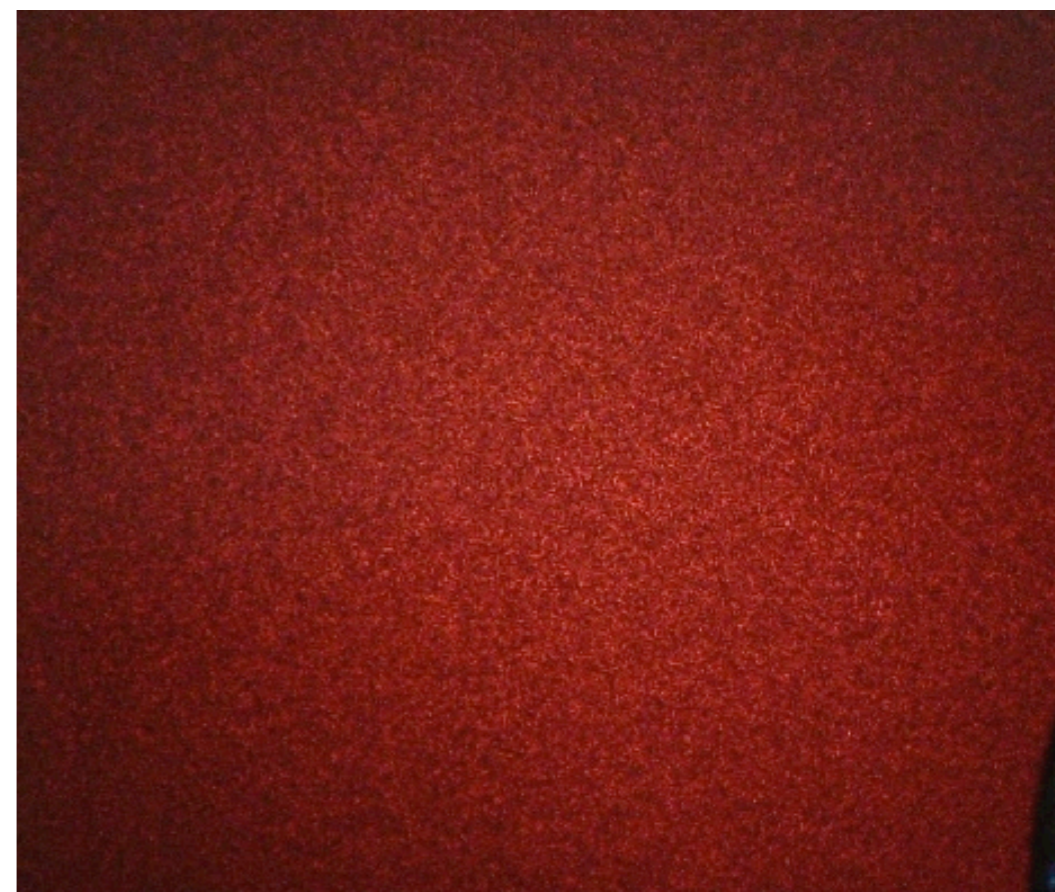
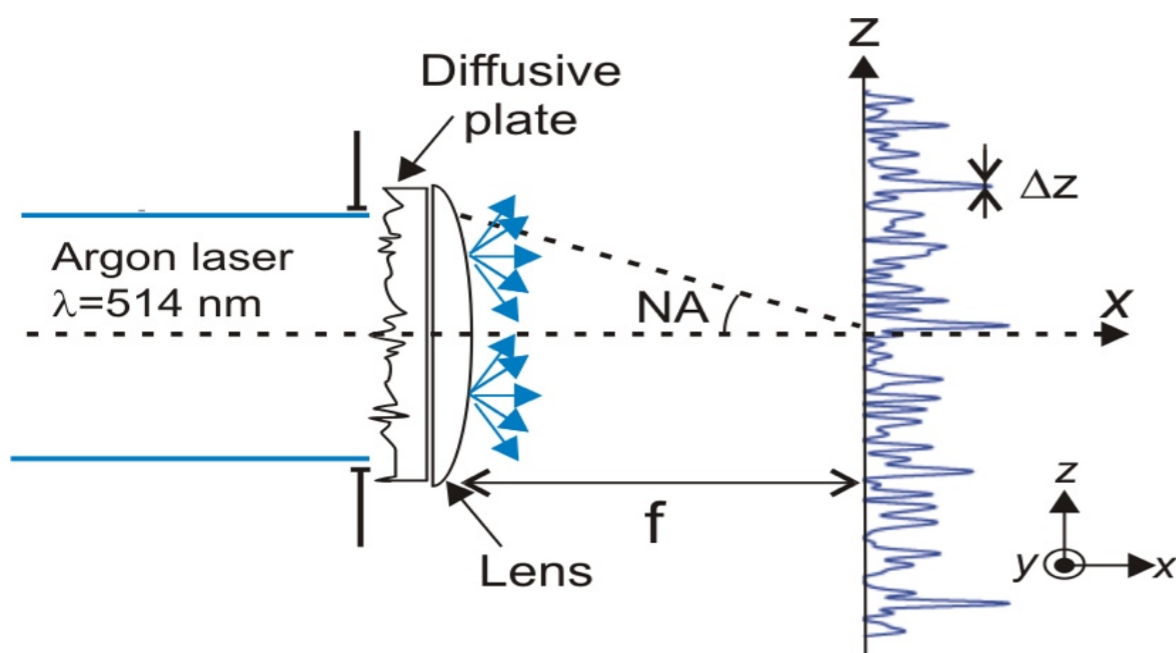

Depth of the optical wells

Indirect (CCD) and direct (using HF spectroscopy) measurements

Statistical properties verified $\sigma_I \sim \langle I \rangle$

Potential depth σ_V calculated from σ_I

$$\sigma_V = \frac{2 \Gamma^2 \sigma_I}{3 2\delta I_S}$$

Good agreement with HF measurements (calibration)

Disorder amplitude definition $\gamma : \gamma = \sigma_V / \mu$

Spatial autocorrelation : $C(\delta z) = \langle V(z)V(z+\delta z) \rangle$

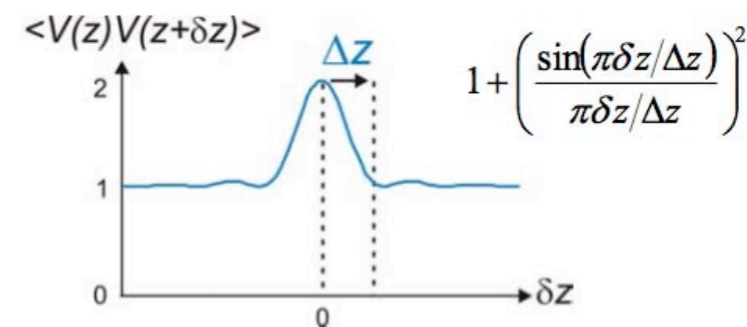

$$\Delta z = \frac{\lambda}{2(N.A.)} = 0.8 \mu m$$

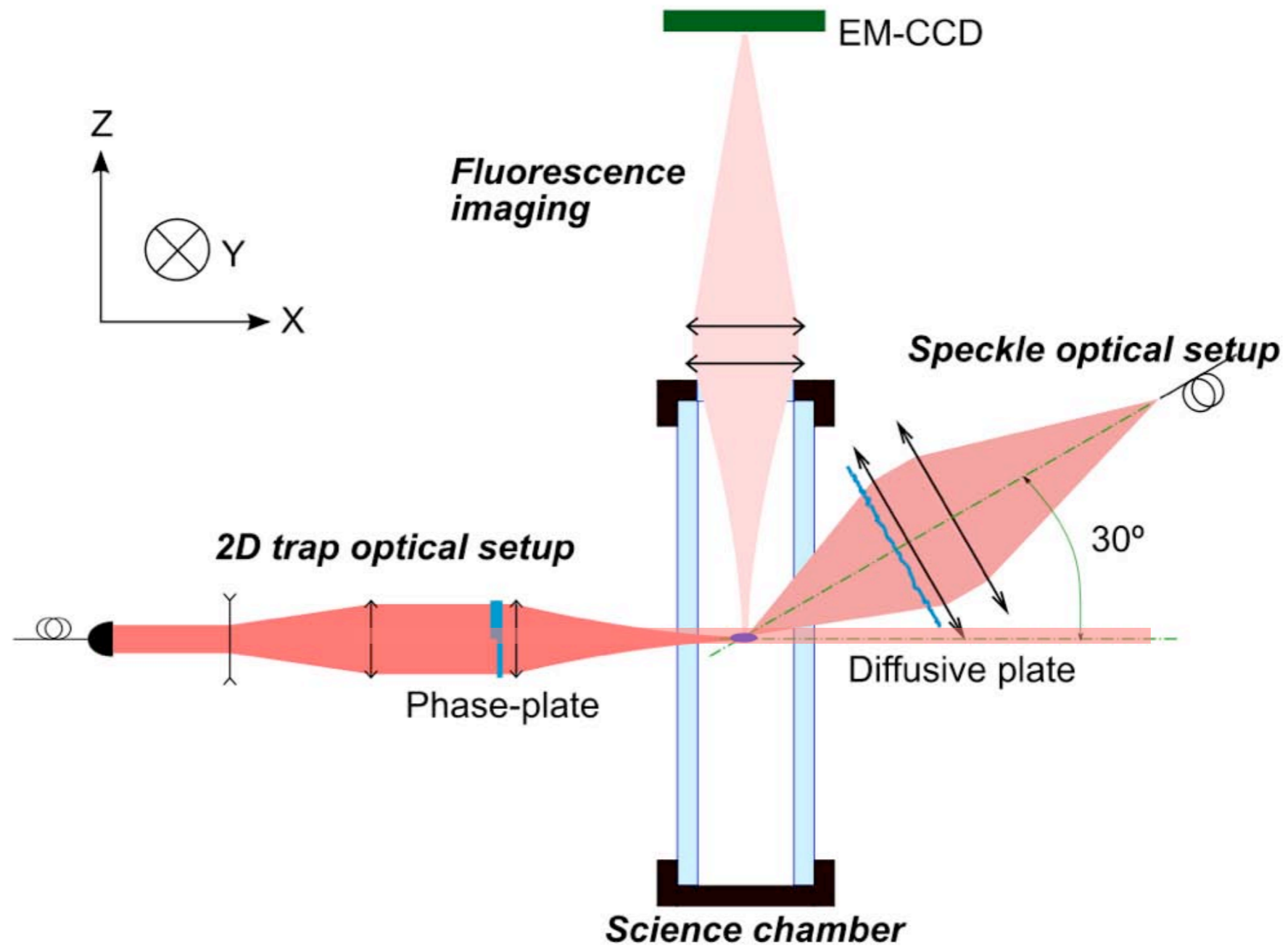

without disorder

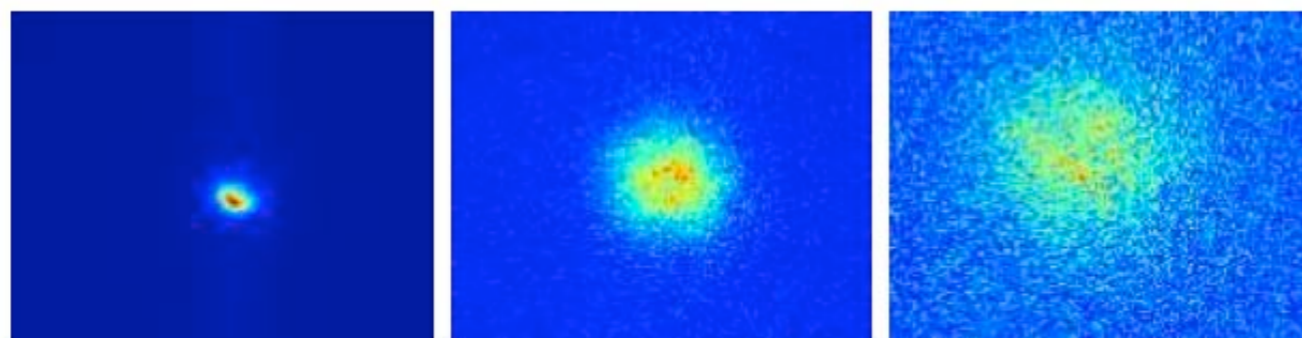

with disorder

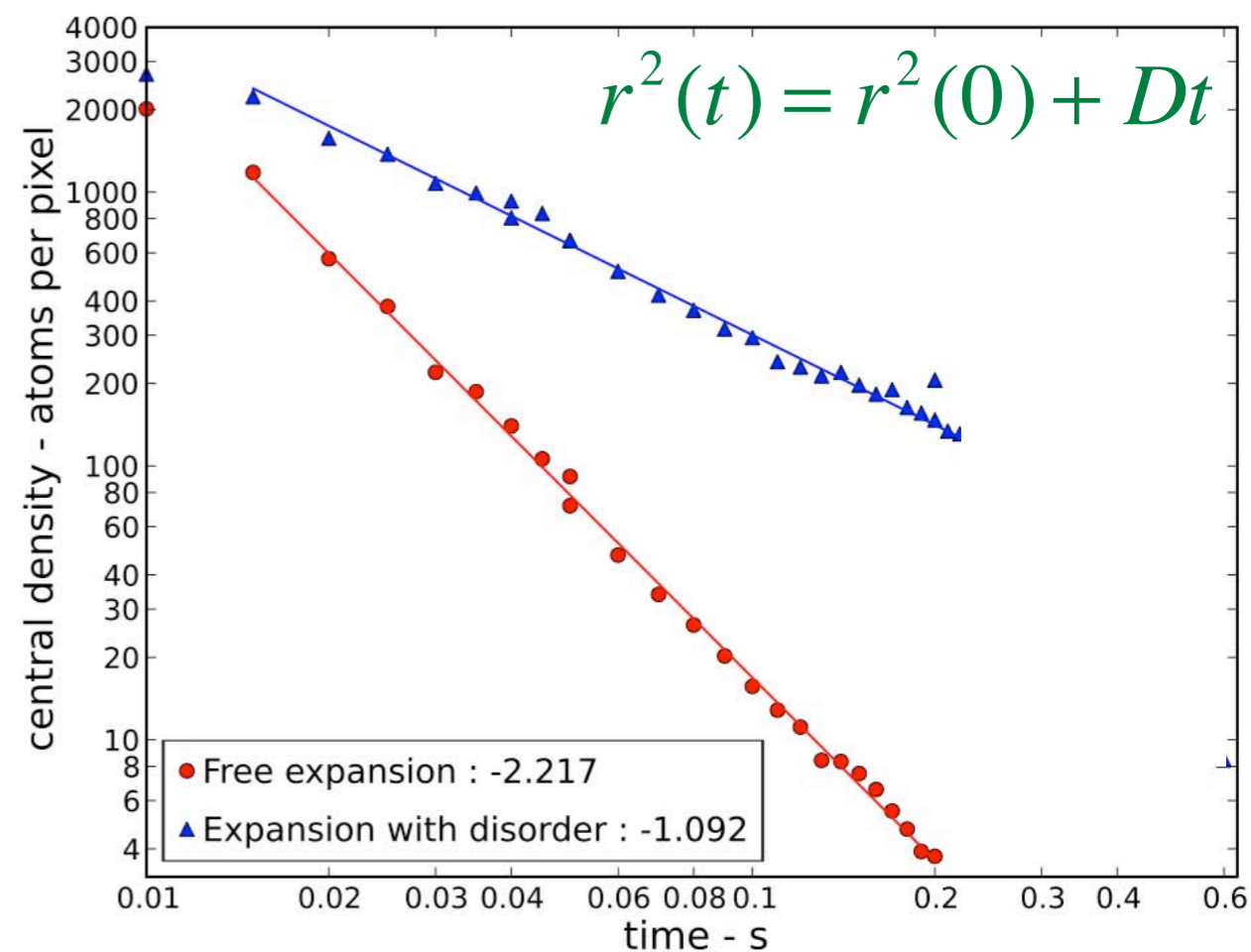
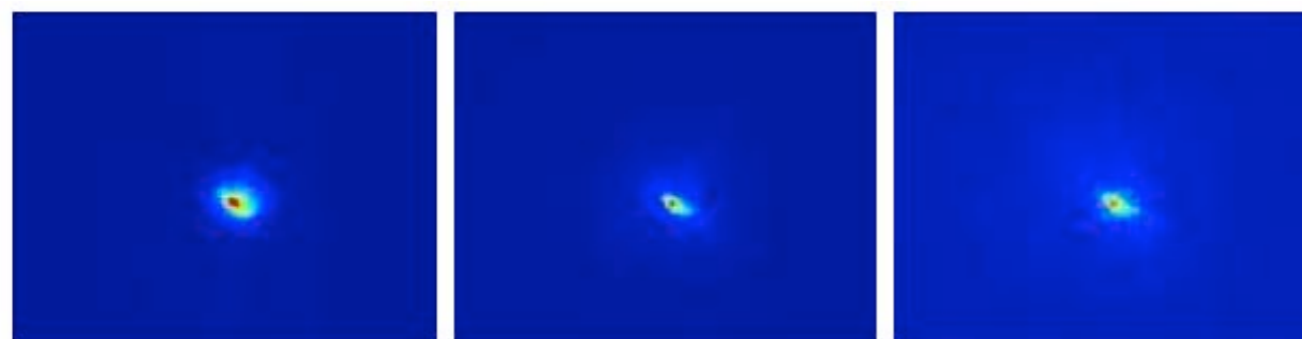

$$r^2(t) = r^2(0) + \frac{k_B T}{M} t^2$$

2D density scales as $1/r$

Since $k_B T / \hbar \omega \approx 6$ and $k \sigma_y \approx 5$, we expect classical dynamics

3 regimes present during the expansion :

Below percolation threshold ($E \approx 0.5$ V) : trapping

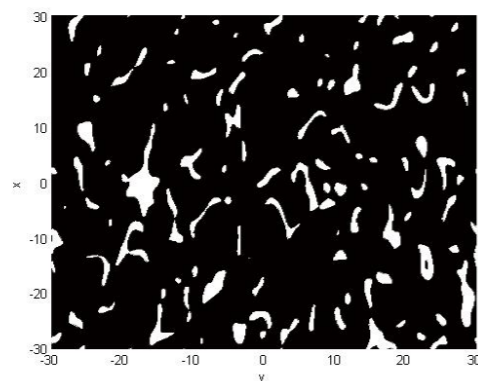

$E/V=0.1$

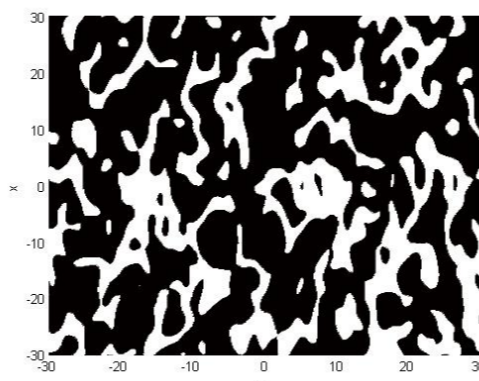

$E/V=0.4$

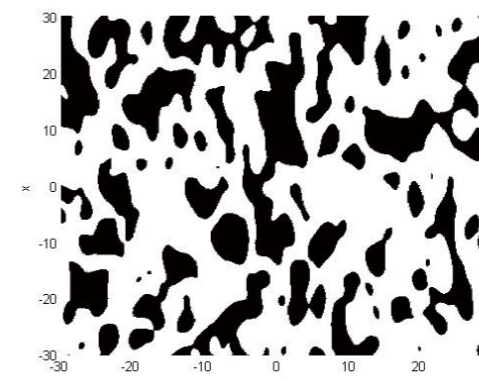

$E/V=1$

L.N. Smith and C.J. Lobb, PRB 1979

A. Weinrib PRB 1982

Since $k_B T / \hbar \omega \approx 6$ and $k \sigma_y \approx 5$, we expect classical dynamics

3 regimes present during the expansion :

Below diffusion threshold ($E \approx 2$ V) : sub-diffusion

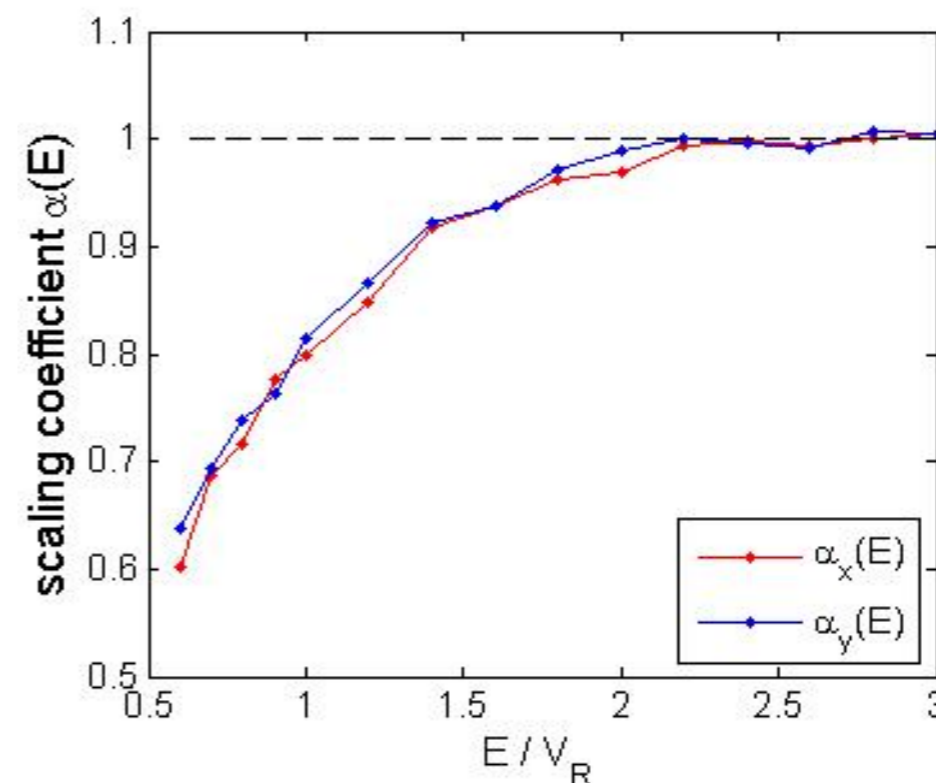
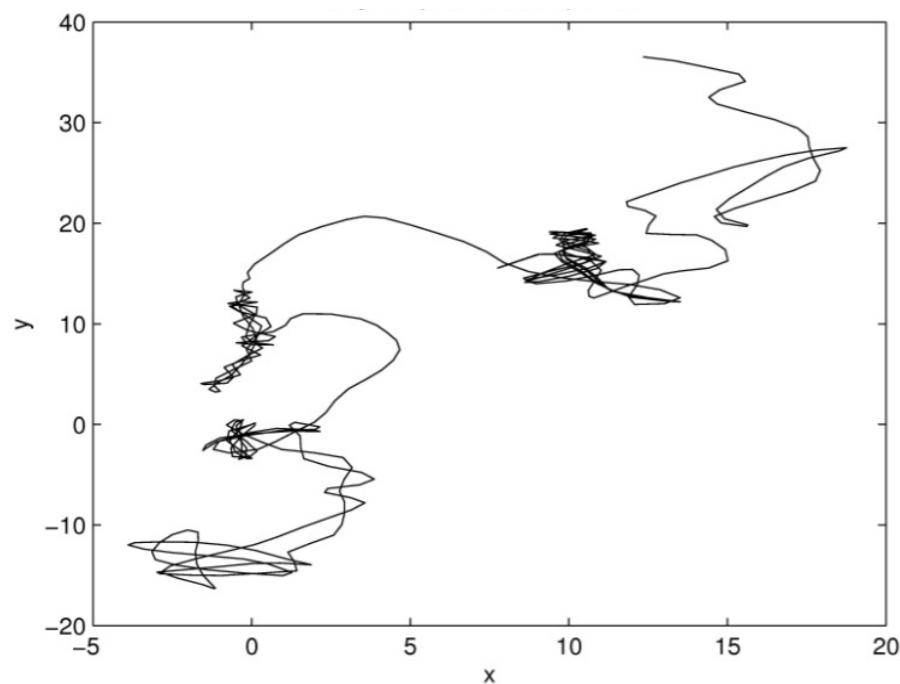

Since $k_B T / \hbar \omega \approx 6$ and $k \sigma_y \approx 5$, we expect classical dynamics

3 regimes present during the expansion :

Diffusion

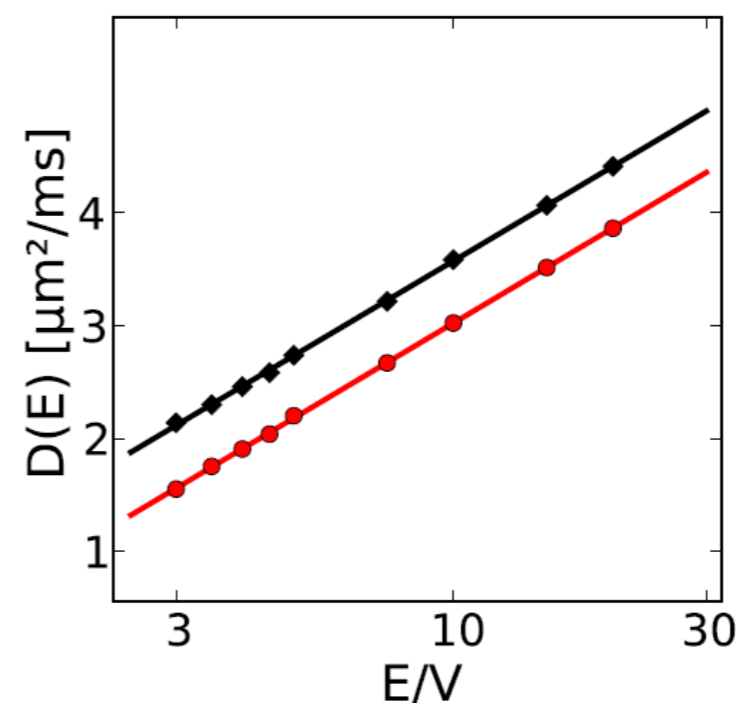
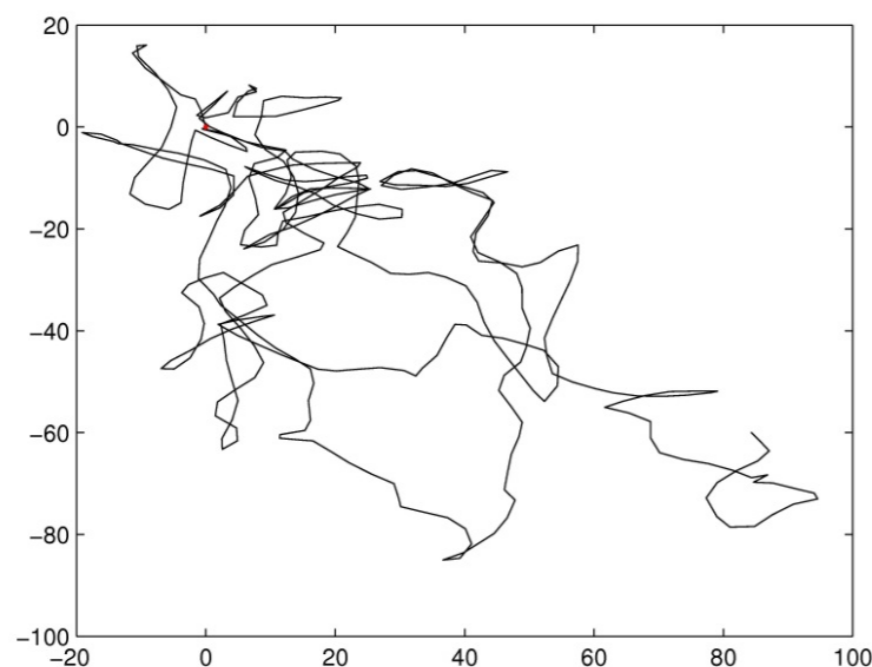

$$\gamma_\xi = 2.8$$

$$D_\xi(E) = D_\xi^0 (E/\bar{V})^{\gamma_\xi} \quad \text{anisotropy of 3.7}$$

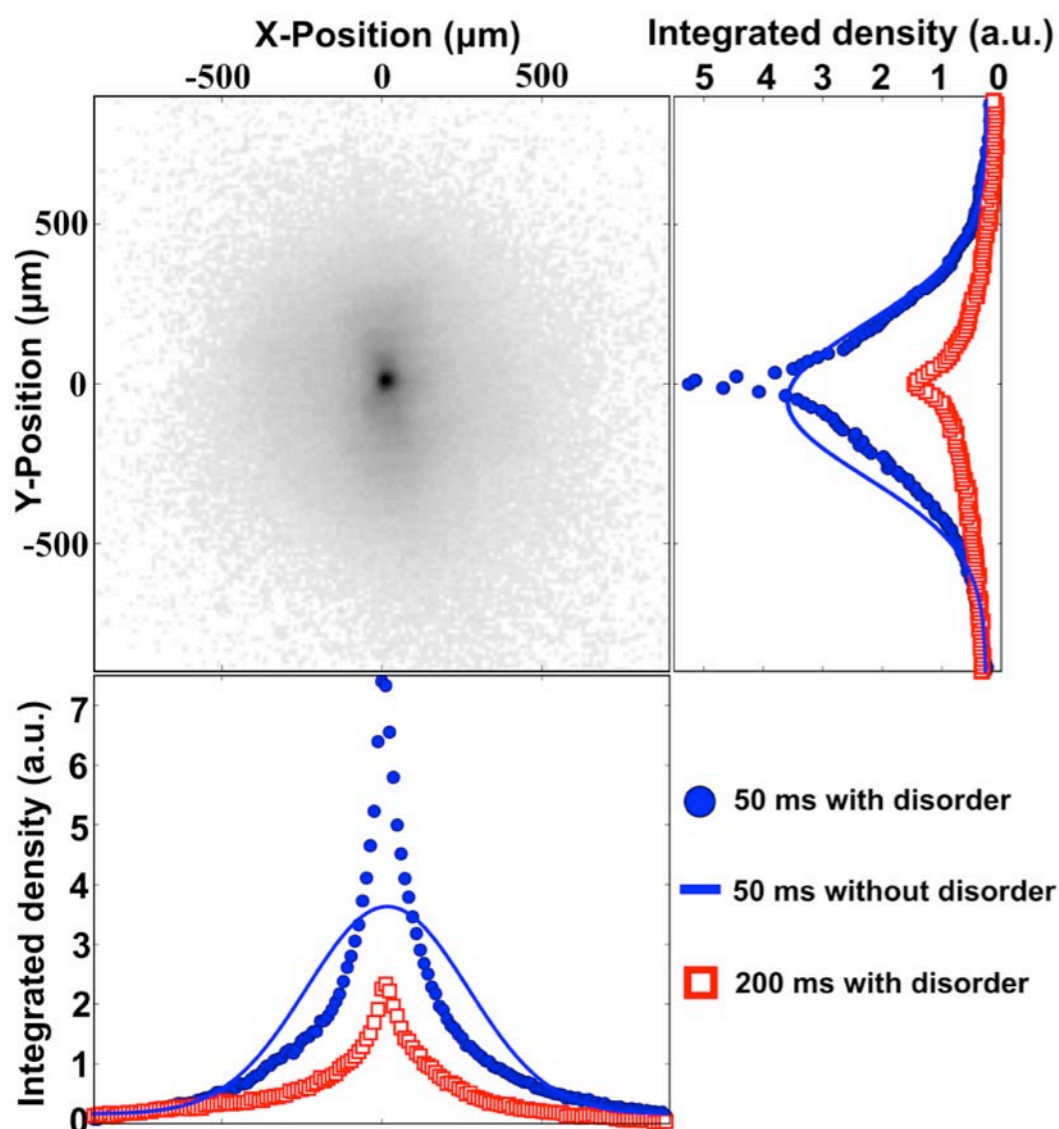

Exp: $\gamma=3.3(3)$

Th: $\gamma_{th}=2.8$

Anisotropy ratio:

Exp: $3.45(15)$

Th: 3.7

Profiles contain ballistic wings
+ diffusive central part

Diffusion coefficients : $D_{x,y}(E)$
Profile = $\text{sum}_E \left(e^{\frac{-r^2}{D(E)t}} \right)$

Pb : what is $D(E)$?

weak scattering : $D(E) \sim D_0 E^\alpha$

$$D_0 \sim 0.13 \text{ mm}^2 \text{ s}^{-1} ; \alpha \sim 3$$

M. Robert-de-saint-Vincent, et al.
arXiv:1004.0312, to appear in PRL

If the length scales become small compared to the de Broglie wavelength and/or the phase coherence length, then quantum mechanics will rule the transport properties.

The probability for a particle to go from point A to point B is the sum of the amplitudes of all possible trajectories.

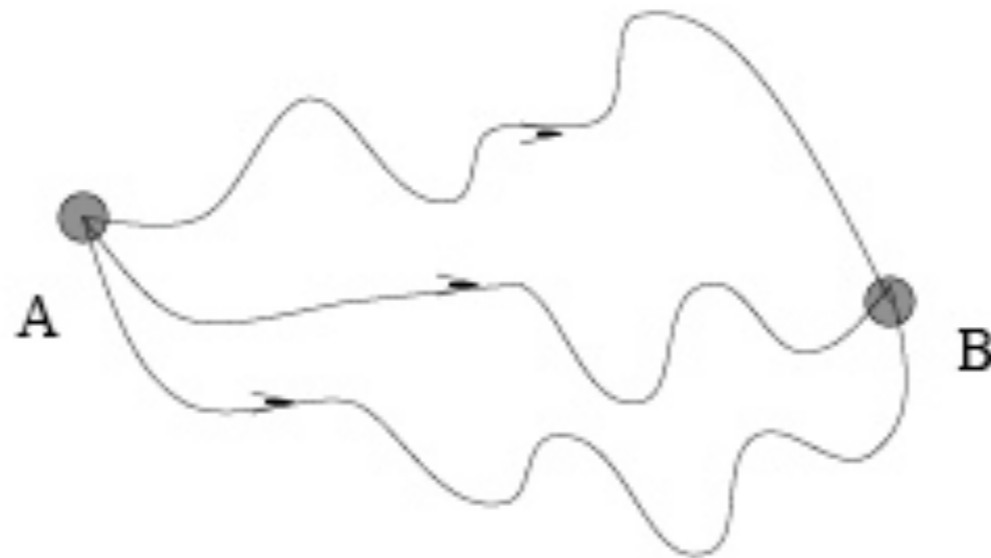

Interference terms can appear and the transport properties can be modified

PHYSICAL REVIEW
VOLUME 109, NUMBER 5
MARCH 1, 1958

Absence of Diffusion in Certain Random Lattices
P. W. ANDERSON
Bell Telephone Laboratories, Murray Hill, New Jersey
(Received October 10, 1957)

This paper presents a simple model for such processes as spin diffusion or conduction in the "impurity band." These processes involve transport in a lattice which is in some sense random, and in them diffusion is expected to take place via quantum jumps between localized sites. In this simple model the essential randomness is introduced by requiring the energy to vary randomly from site to site. It is shown that at low enough densities no diffusion at all can take place, and the criteria for transport to occur are given.

If mean free path smaller than de Broglie wavelength:
constructive interference of trajectories returning to
origin: **localized states**: insulator

Crossed dipole trap with 1 small beam

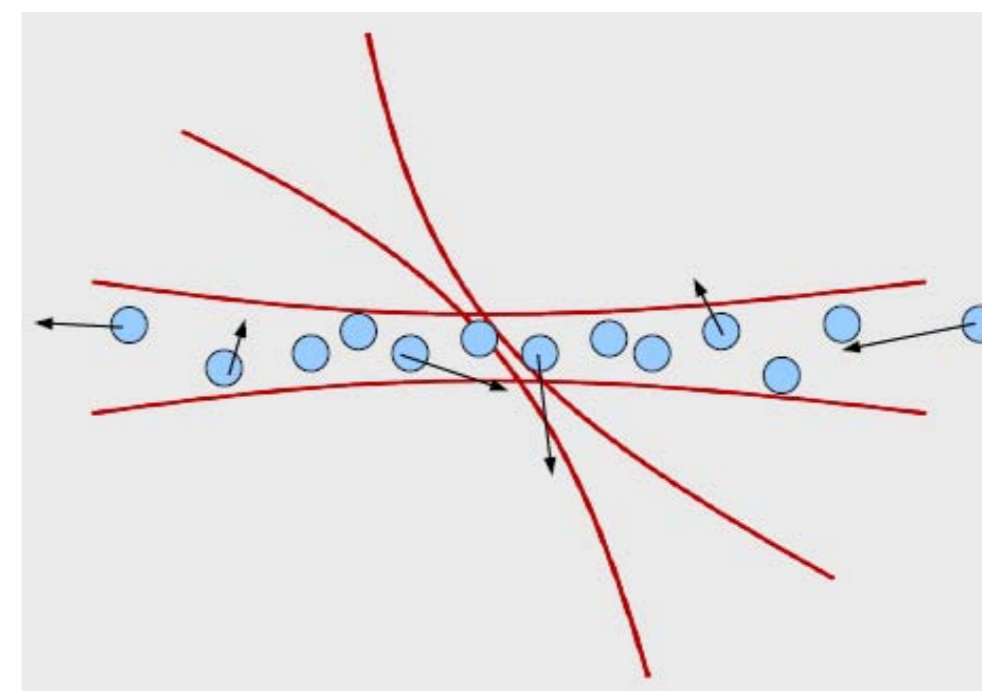
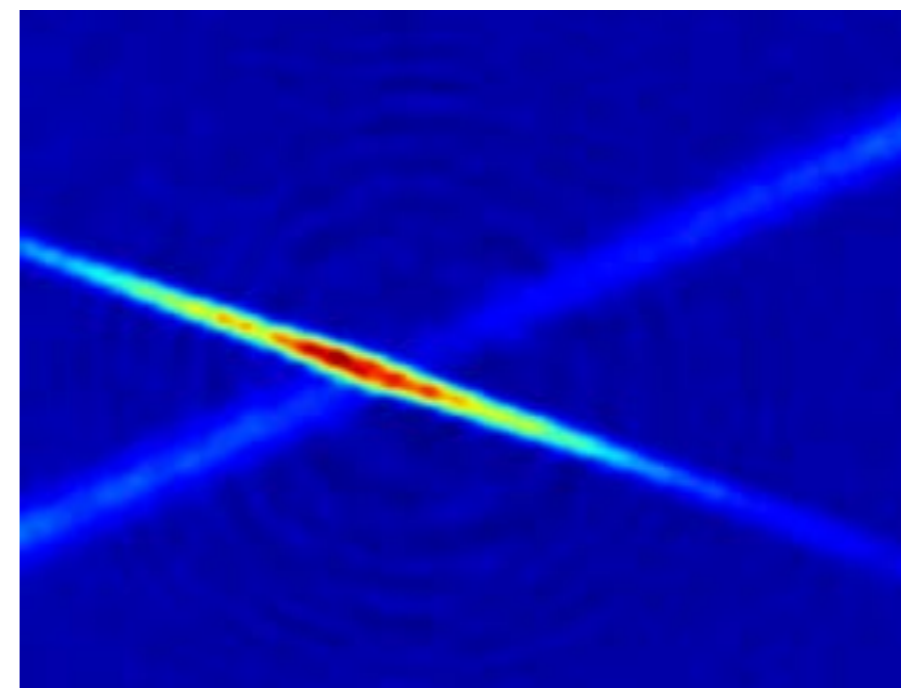
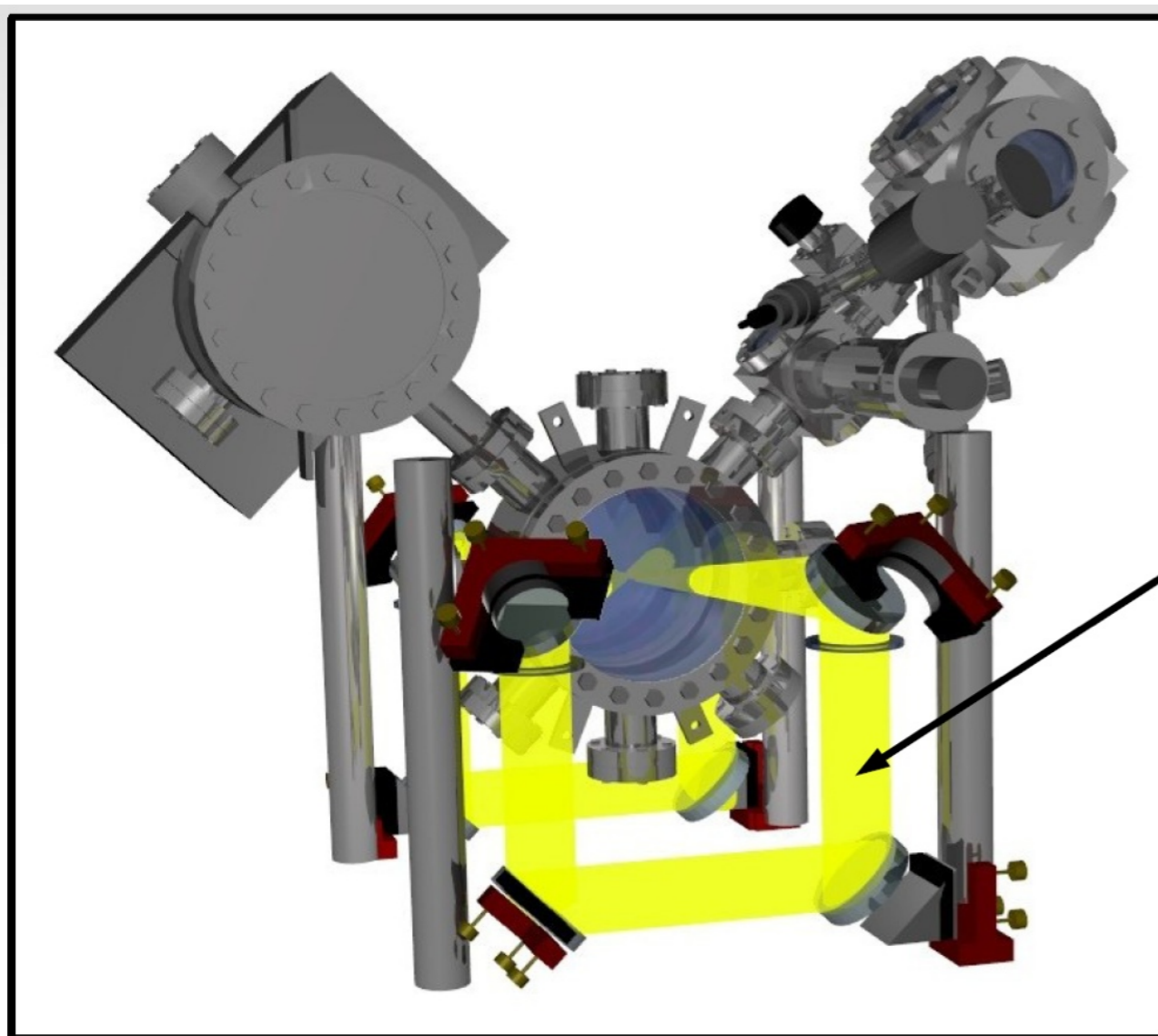

J.-F. Clément, *et al.*, Phys. Rev. A **79**, 061406(R) (2009).

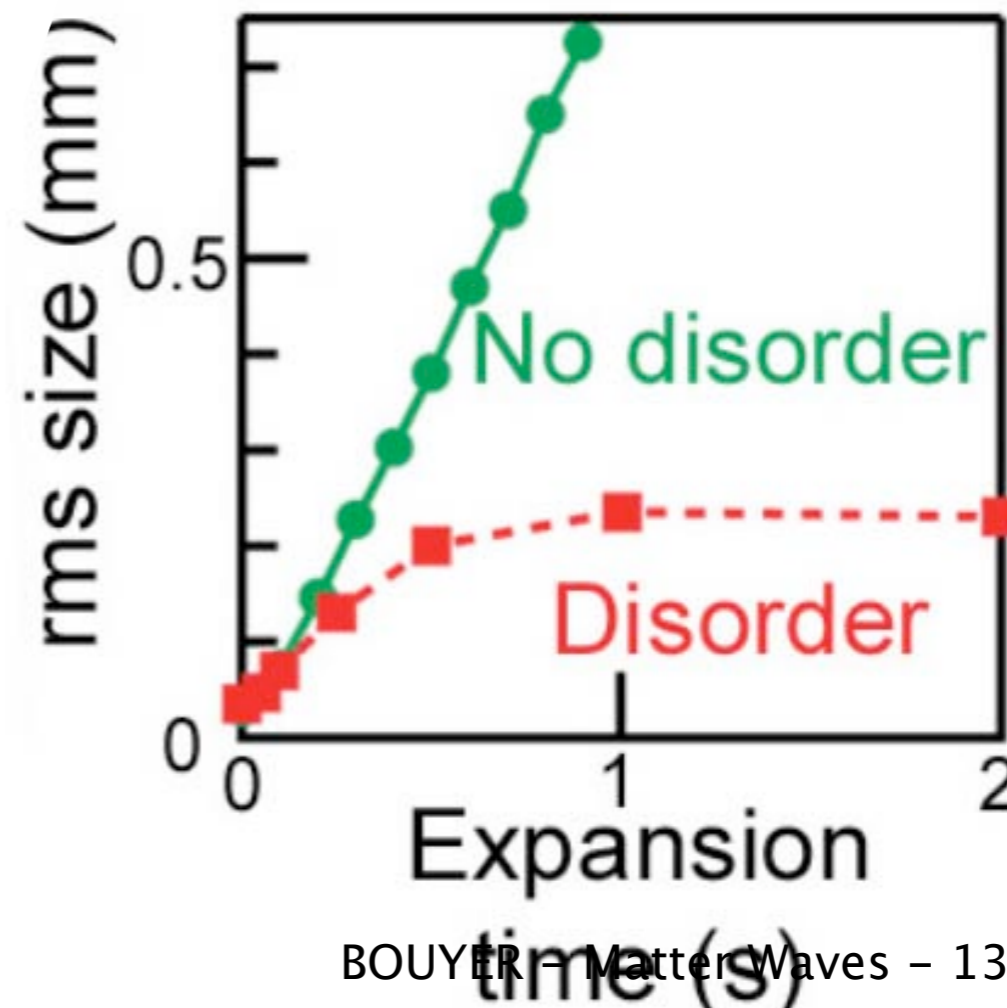
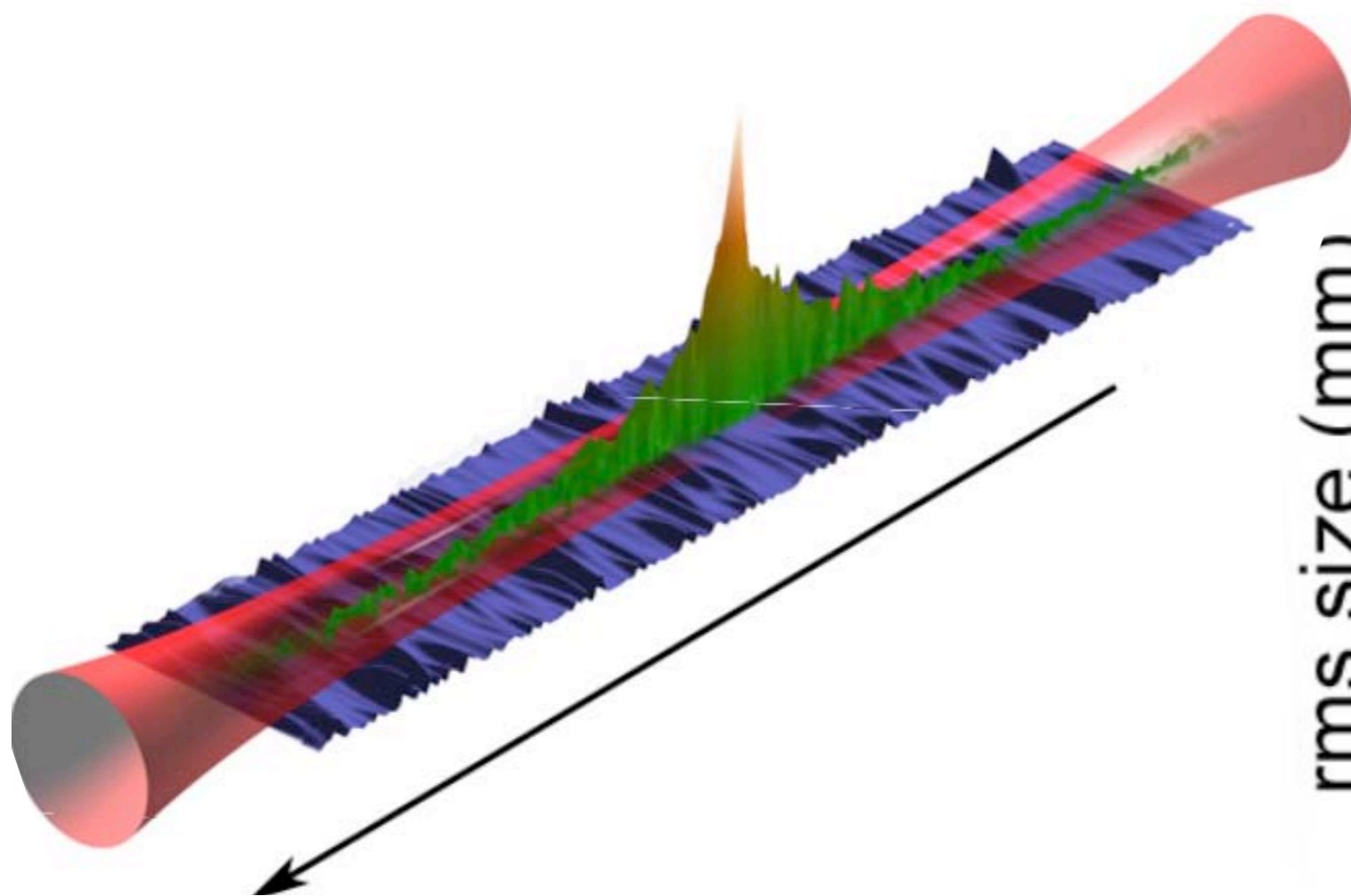

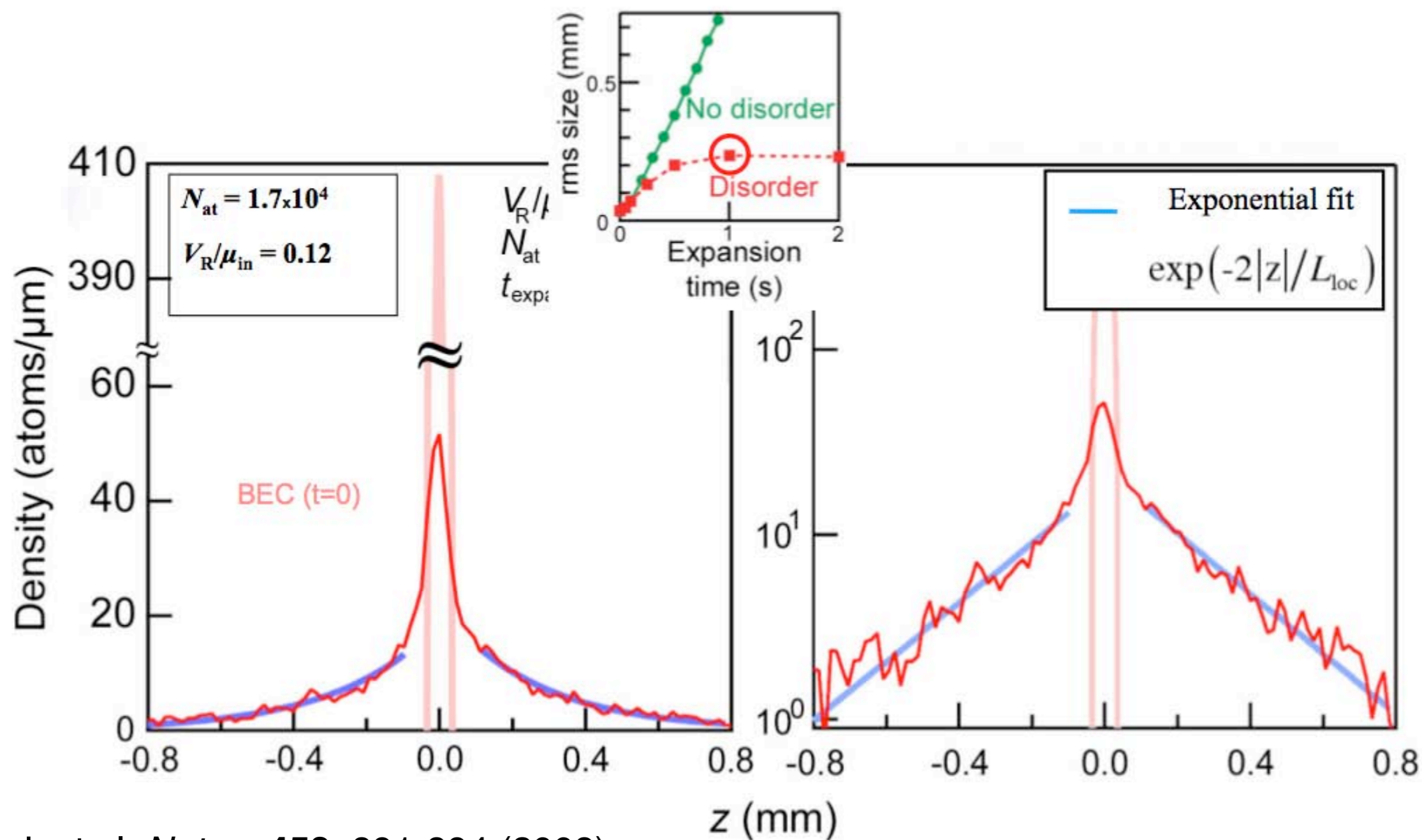

Billy, J. et al. *Nature* **453**, 891-894 (2008).

MATTER WAVES AND ATOM INTERFEROMETRY



TEST FUNDAMENTAL LAWS SUCH AS GENERAL RELATIVITY, DETECT RESSOURCES

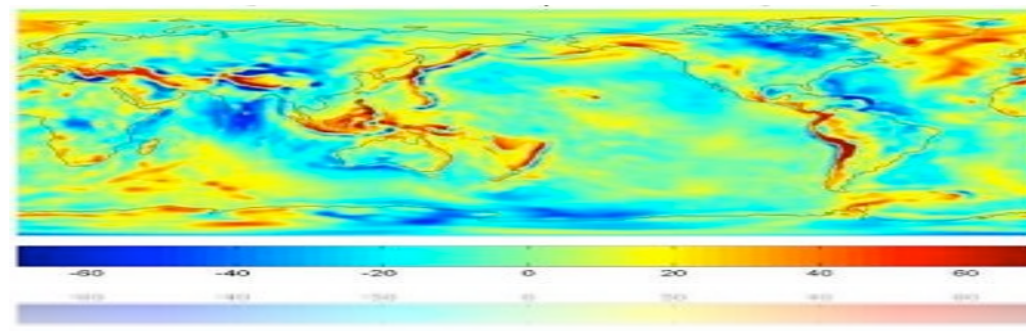

«BUILD» COHERENT MATTER WAVE BEAMS, ATOM LASERS ...

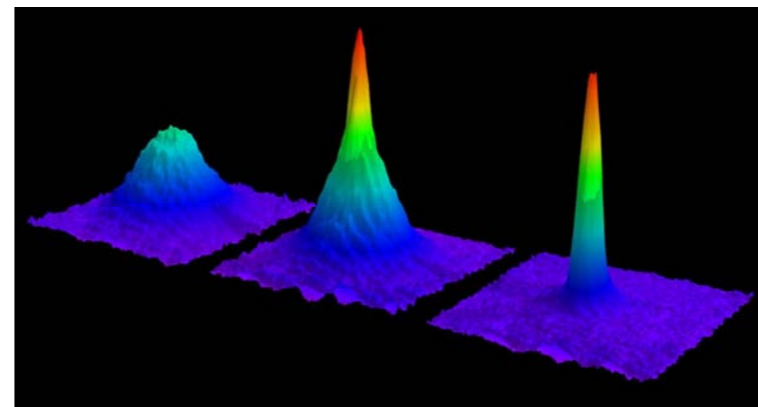
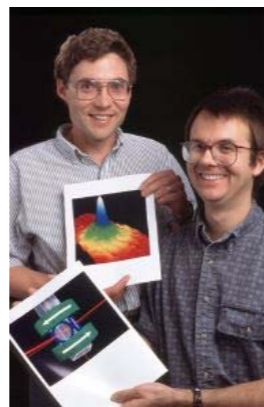

SIMULATE «QUANTUM MATERIALS» WITH ATOMS AND LIGHT

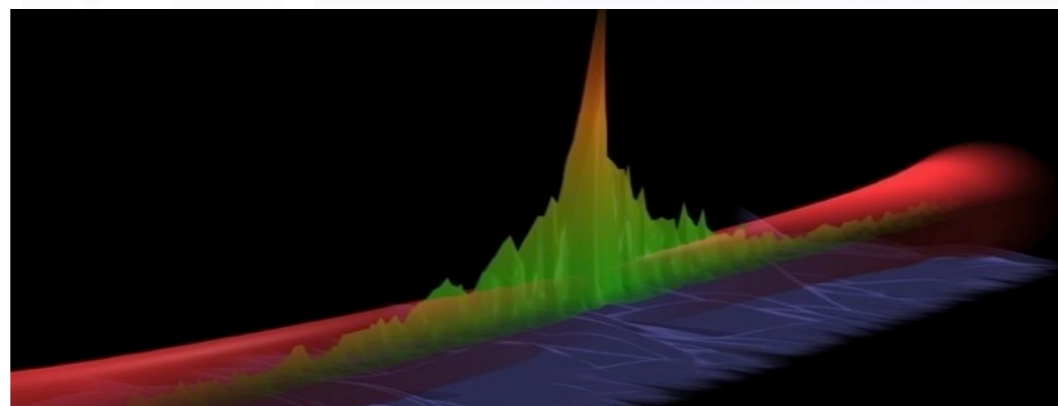

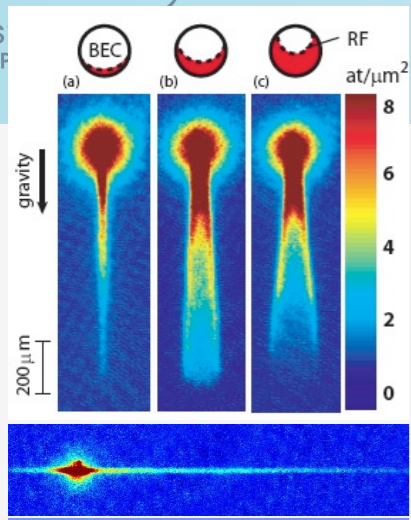

Atom laser and quantum transport

V. Josse

J. Billy, A. Bernard, P. Cheinet

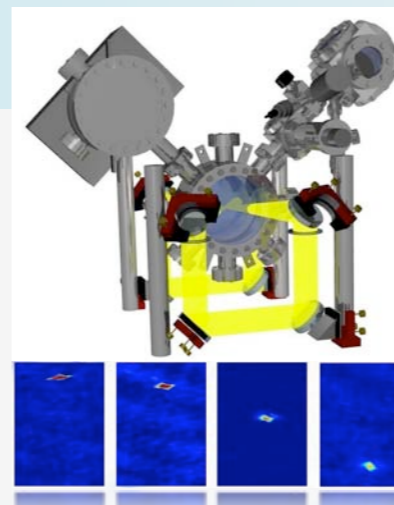

Degenerate mixtures in optical structures

T. Bourdel

J-P. Brantut, M. Robert de Saint Vincent

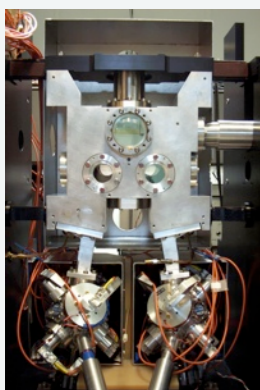

Applications of atom interferometry

B. Battelier

A. Landragin (LNE-SYRTE)



Coherent Atom Sources and Atom Interferences

From fundamental properties of Atom laser to quantum atom sensor applications



Atom interferometry in microgravity

G. Stern, A. Bresson (ONERA), A. Landragin (LNE-SYRTE)

R. Geiger

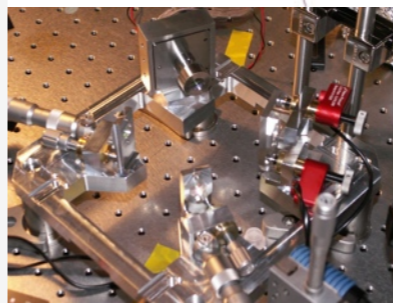
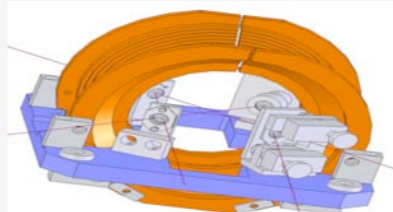

BEC in optical high finesse resonators

A. Landragin (LNE-SYRTE)

S. Bernon, A. Bertoldi, T. Vanderbruggen