



HAL
open science

CO capture study in advanced Integrated Gasification Combined Cycle

Mohamed Kanniche, Chakib Bouallou

► **To cite this version:**

Mohamed Kanniche, Chakib Bouallou. CO capture study in advanced Integrated Gasification Combined Cycle. Applied Thermal Engineering, 2007, 27 (16), pp.2693. 10.1016/j.applthermaleng.2007.04.007 . hal-00498953

HAL Id: hal-00498953

<https://hal.science/hal-00498953>

Submitted on 9 Jul 2010

HAL is a multi-disciplinary open access archive for the deposit and dissemination of scientific research documents, whether they are published or not. The documents may come from teaching and research institutions in France or abroad, or from public or private research centers.

L'archive ouverte pluridisciplinaire **HAL**, est destinée au dépôt et à la diffusion de documents scientifiques de niveau recherche, publiés ou non, émanant des établissements d'enseignement et de recherche français ou étrangers, des laboratoires publics ou privés.

Accepted Manuscript

CO₂ capture study in advanced Integrated Gasification Combined Cycle

Mohamed Kanniche, Chakib Bouallou

PII: S1359-4311(07)00133-0
DOI: [10.1016/j.applthermaleng.2007.04.007](https://doi.org/10.1016/j.applthermaleng.2007.04.007)
Reference: ATE 2155

To appear in: *Applied Thermal Engineering*

Received Date: 13 December 2006
Revised Date: 21 March 2007
Accepted Date: 7 April 2007

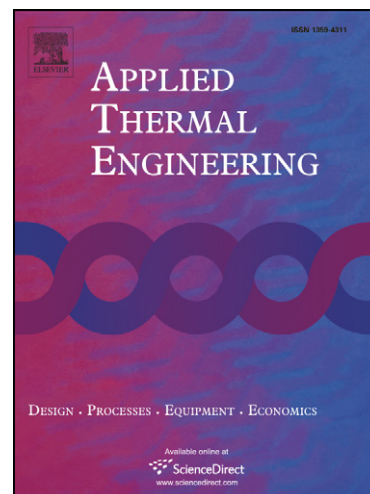

Please cite this article as: M. Kanniche, C. Bouallou, CO₂ capture study in advanced Integrated Gasification Combined Cycle, *Applied Thermal Engineering* (2007), doi: [10.1016/j.applthermaleng.2007.04.007](https://doi.org/10.1016/j.applthermaleng.2007.04.007)

This is a PDF file of an unedited manuscript that has been accepted for publication. As a service to our customers we are providing this early version of the manuscript. The manuscript will undergo copyediting, typesetting, and review of the resulting proof before it is published in its final form. Please note that during the production process errors may be discovered which could affect the content, and all legal disclaimers that apply to the journal pertain.

CO₂ capture study in advanced Integrated Gasification Combined Cycle

Mohamed Kanniche¹, Chakib Bouallou^{2*}

⁽¹⁾ EDF, Research and Development Division, Fluid Mechanics Energies and Environment
Department, 6 quai Watier 78401 Chatou cedex, France. Tel : 33 1 30 87 71 08,

Email: mohamed.kanniche@edf.fr

⁽²⁾ Centre Énergétique et Procédés (CEP), Ecole Nationale Supérieure des Mines de Paris,
60, Boulevard Saint Michel, 75006 Paris, France. Tel: 33 1 40 51 91 11,

Email: chakib.bouallou@ensmp.fr

* corresponding author

ACCEPTED MANUSCRIPT

Abstract

This paper presents the results of technical and economic studies in order to evaluate, in the French context, the future production cost of electricity from IGCC coal power plants with CO₂ capture and the resulting cost per tonne of CO₂ avoided. The economic evaluation shows that the total cost of base load electricity produced in France by coal IGCC power plants with CO₂ capture could be increased by 39% for 'classical' IGCC and 28% for 'advanced' IGCC. The cost per tonne of avoided CO₂ is lower by 18% in 'advanced' IGCC relatively to 'classical' IGCC. The approach aimed to be as realistic as possible for the evaluation of the energy penalty due to the integration of CO₂ capture in IGCC power plants. Concerning the CO₂ capture, six physical and chemical absorption processes were modeled with the Aspen Plus™ software. After a selection based on energy performance three processes were selected and studied in detail: two physical processes based on methanol and Selexol™ solvents, and a chemical process using activated MDEA. For 'advanced' IGCC operating at high-pressure, only one physical process is assessed: methanol.

Keywords: CO₂ capture, coal, slurry, methanol, MDEA, power plant, avoided CO₂

Nomenclature

IGCC:	Integrated gasification combined cycle
ASU:	Air separation unit
LHV:	low heating value
MEA:	methylethanolamine
MDEA:	methyldiethanolamine
A-MDEA:	activated methyldiethanolamine
NMP:	N-methyl-pyrrolidone
AMP:	amine 2-amino-2-methyl-1-propanol
Selexol™:	process using dimethyl ether of polyethylene glycol (DMPEG)
Syngas:	synthetic gas produced by the gasification

1. Introduction

To meet the growing world demand for energy, which will be driven increasingly by the developing countries, recourse to fossil fuels will remain dominant at least for the first half of the 21st century. The tendency for CO₂ emissions to increase will therefore be considerable, though the objective should be to stabilize the concentration of CO₂ in the atmosphere to an acceptable level: for example 550 ppm in 2100. This objective cannot be achieved by simply stabilizing the quantities of CO₂ discharged into the atmosphere, but by reducing them by at least a factor of 2 or 3 as a world average [1]. In addition to the use of nuclear power and renewable energy, the need to reduce CO₂ emissions substantially could therefore lead to the capture and storage of the CO₂ emitted by large combustion plants in underground geological formations (depleted hydrocarbon reservoirs or deep saline aquifers) as it does not seem possible to envisage storage of CO₂ in the ocean in the near future.

Integrated Gasification Combined Cycles (IGCC) is the type of power technology particularly favorable for carbon dioxide capture as this latter can be removed at a convenient stage of the process where its partial pressure is high [2]. The various options analyzed in the literature concerning this integration are described in [3], [4] and [5]: pre-combustion with a modification of the power station structure; post-combustion with a low pressure separation before the stack in an “end of pipe” separation process; decarbonization of the fuel by producing hydrogen, methanol or ammonia; modified cycle as oxy-combustion O₂/CO₂ cycle. The CO₂ removal requires the addition of two main units: a CO shift conversion unit

downstream from the gas dedusting system and a CO₂ separation and compression unit meeting the transport conditions.

This paper presents a summary of the results of technical and economic studies conducted by EDF-R&D in collaboration with various organizations: Ecole des Mines de Paris, Technip and UOP for the CO₂ capture processes at the power plant, with the financial support of ADEME, the French agency for environment and energy management, and with Géostock and Tractebel for the CO₂ transport and storage. The aim was to evaluate, in the French context, the levelized cost of electricity from coal with and without CO₂ capture and storage and the cost per tonne of CO₂ avoided. The coal option was chosen on account of the large proven reserves of this fossil fuel (2 to 3 centuries at present consumption rate) and oxygen blown IGCC was selected as it seems to be the best alternative for electricity generation from coal in the medium/long term [6], [7] and [8], showing some specific advantages:

- IGCC is a clean coal technology that today offers significant reduction in air-pollutant emissions,
- In this process, coal reacts under pressure with oxygen and steam in the gasifier producing a syngas which can be shifted to CO₂/H₂ mixture in a catalytic reactor leading to a high partial pressure of CO₂ which is favorable for its capture,
- After CO₂ capture, the fuel gas is essentially hydrogen which can be used to generate electricity in a combined cycle or, in the future, in fuel cells in order to increase the overall efficiency, and

- IGCC may offer opportunities to produce power as well as synthetic fuels and chemicals.

We focus in this paper on a CO₂ separation in order to integrate this option into the power plant cycle, upstream from the gas turbine.

2. Capturing CO₂ at the power plant

EDF-R&D has carried out an investigation, in close collaboration with the Ecole des Mines de Paris, in order to select the best processes for collecting CO₂ to be integrated into an IGCC power plant and to calculate its impact on efficiency. Moreover, with the assistance of the Technip Company and UOP, the investment costs associated with the new equipment have been estimated and the total cost per kWh (with and without CO₂ capture) has been evaluated.

2.1. Capture technology

Various processes may be envisaged for separating the CO₂: chemical or physical absorption (or an association of both), adsorption onto solids, separation by membranes and cryogenic separation. Obviously these processes are not all equivalent, nor all at the same stage of development. Cryogenic separation needs too much energy and appears to be too expensive; separation by membranes is attractive (a principle similar to filtration) but today the 'right' membranes required are under development and do not yet exist for an industrial scale; adsorption onto a solid does not seem very suitable for processing huge volumes of gas. In the end, only physical and chemical (or mixed) absorption methods seem suitable for large

power plants, but the choice of the ‘best’ solvent is still a very open question. A typical absorption process is shown in Figure 1: the gas to be treated is injected at the bottom of the absorption column after it is cooled at a first step in a heat exchanger which heats the treated gas exiting the column and depending on the process type (e.g. for methanol, NMP and Selexol™ processes) in a second step using a refrigeration system. The solvent is injected at the top of the absorption column to absorb the CO₂ from the gas. The rich solvent is then heated by exchanging heat with the lean solvent coming from the desorption column. The solvent is regenerated in the desorption column using low-pressure steam condensation in the reboiler.

CO₂ separation processes with chemical solvents (alkanolamines) have been industrialized since the seventies and licensors have been looking these last few years at specific solvent formulations: primary or secondary amines and anti-corrosion additives, tertiary amines with promoters or activators and with antifoaming additives. Mixing of chemical solvents, such as tertiary amines and a relatively small amount of the primary amine, aims to combine the advantages of the two solvents. The target of such mixed chemical solvents is to achieve a better absorption capacity, to avoid solvent degradation and to limit corrosion. Physical solvents (methanol, propylene carbonate, n-methyl-pyrrolidone (NMP), Dimethylether of polyethylene glycol (Selexol™)) are known for their chemical stability and for a non-induced corrosion effect. Moreover, their high absorption capacities make them interesting for bulk removal. However, methanol needs low operating temperatures because of its higher volatility. The high volatility is a disadvantage with regard to the potential solvent losses. Even if the process streams are chilled to -30°C, it is necessary, before the transport and the storage of the

CO₂, to add to the CO₂ compression unit a wash water column to capture methanol with water from the CO₂ stream (Figure 2). For the CO₂ transportation, the water content should not exceed 20 ppm to avoid corrosion problems. This threshold value was specified by gas transportation experts of Tractebel licensed by EDF for CO₂ transportation. For this purpose a dehydration system based on tri-ethylene-glycol (TEG) is added in the compression unit (Figure 2). For methanol recovery from water a distillation column is then added to the CO₂ capture unit (Figure 3). NMP also requires a refrigeration system to meet relatively low temperatures. The refrigeration system uses electricity for the compression of the refrigeration media, which means a higher energy penalty for the process than cooling water.

Mixing the chemical and physical solvents (hybrid solvent) allows an increased CO₂ absorption capacity compared to chemical solvent alone. The solubility of carbon dioxide in primary or secondary amines is improved by the addition of NMP, [9]. The solubility of carbon dioxide is compared in a mixture of methyldiethanolamine, MDEA and methanol, and in methanol, [10]. The physical solvent polarity and permitivity are significant on the ionization of the species and on reaction kinetics. However, the kinetics of CO₂ absorption by physical solvents and amines, in aqueous solution form or not, are still unknown.

In this work, six processes are evaluated as stand alone units, fed with the same synthesis gas (50 kg/s and 24 bar): three physical processes, methanol, n-methyl-pyrrolidone (NMP), Selexol, and three chemical processes, a sterically hindered amine 2-amino-2-methyl-1-propanol (AMP), activated methyldiethanolamine (A-MDEA) and a mixture of methyldiethanolamine and monoethanolamine in aqueous solution (MDEA 25 mol % /MEA 5

mol %). We considered the electrical and thermal consumption for the CO₂ capture. The electrical consumption is similar for the six processes, while thermal consumption is rather high for chemical processes as can be seen in Figure 4. Then three processes are selected for the integration in the global IGCC system. These processes are: methanol, Selexol and activated MDEA. The activated MDEA process was integrated into the IGCC and added to the comparison study in order to evaluate a chemical process relative to the two physical ones.

Particular attention was paid to thermodynamic models. A simple equation of state, Redlich Kwong Soave, is chosen for the synthesis gas and the flue gas, but the thermodynamic model Steamnbs [11] (based on the 1984 NBS/NRC steam table correlation for thermodynamic properties and International Association for Properties of Steam IAPS for the transport properties) is used for pure water and steam, and the Electrolyte Non Random Two Liquid model for the aqueous electrolyte system. The Redlich Kwong Soave equation of state, with the Holderbaum and Gmehling mixing rule [12] is chosen for the CO₂ capture process. The calculation of the activity coefficient model is done by Uniquac for which the interaction parameters are fitted on measured data from the literature [13]. The CO₂ methanol equilibrium, [13] and [14], was studied and modeled to optimize the methanol loss calculation in the CO₂ stream leaving the desorption column. The simulation of the absorption and desorption is performed with a rigorous distillation model.

Moreover, an optimized case has been studied, which consists in the adjustment of the thermodynamic parameters and in improvement of the capture process. Hydrogen co-absorption in methanol has been studied in order to improve the calculation of the hydrogen

losses by absorption in the solvent. The hydrogen/methanol binary interactions were measured and the interaction parameters of the thermodynamic model (Uniquac) were calculated. The methanol flow rate is slightly reduced when the H₂-methanol binary interaction parameter is taken into account, leading to a reduced consumption of steam in the thermal regeneration. The separation process flow diagram has been improved by the addition of two flash drums in order to reduce the CO₂ compression power.

Finally, the solvent flow rate is optimized to perform the CO₂ separation with a minimum of steam consumption in the thermal regeneration. The solvent regeneration column is calculated for each case, as a residual CO₂ concentration is determined in the lean solvent in order to be compatible with the required CO₂ purity in the top of the absorption column. A low operating temperature of -30 °C is chosen for the methanol in order to minimize the solvent losses and to maximize the carbon dioxide solubility.

2.2. Integration to IGCC systems

For a 'classical' IGCC power plant, the study was based on the Puertollano [15] scheme operating at 27 bars and where 100% of air feeding the air separation unit (ASU) producing oxygen and nitrogen is extracted from the gas turbine (full integration). As the coal is injected in dry form using pure nitrogen (given by the ASU) as the transportation medium from coal grinder to the gasifier, the necessary steam for the gasification is extracted from the combined cycle. The CO₂ separation unit was integrated downstream from the existing desulphuration unit, and after a CO shift conversion unit (Figure 5). The integration of the three selected

processes was performed as realistically as possible: avoiding great modifications of the existing IGCC, conserving the existing sulphur removal unit, adding a shift conversion in the appropriate part of the system to conserve equilibrated $\text{H}_2\text{S}/\text{CO}_2$ acid gas for the Claus plant (pure sulphur production), fully integrating the combined cycle and the shift conversion (this latter produces a smaller amount of Medium Pressure steam than it consumes), bleeding steam from the appropriate part of the combined cycle, thermal balancing of the feed water flash tank, using saturated steam instead of superheated steam for the solvent regeneration column, adjusting thermodynamic parameters of gas/solvent binary interactions (the hydrogen/methanol binary interactions are measured, others are taken from published experimental data), adding steam to the gas turbine in order to ensure low NO_x emission as the synthetic gas now has hydrogen as its major component, conserving the design parameters of both gas turbine and steam turbine. The design parameters of the gas turbine (the turbine inlet temperature and the equivalent weight flow) and of the steam turbine (Stodola criteria) are taken into account, and the reduction of the NO_x production in the combustion chamber is considered. Thus the choice is made to feed the gas turbine of the combined cycle with a diluted synthesis gas, having a low heating value similar to that produced without the CO_2 capture. As a consequence, a significant amount of steam is injected into the combustion chamber. We focus on the energy consumption of CO_2 capture and on the energy penalty of optimised retrofit IGCC.

Concerning the ‘advanced’ IGCC system (Figure 6) which is fed with a mixture of coal and water (slurry), the shift conversion is inserted immediately downstream from the gasification system as the synthetic gas contains enough water to convert CO into CO_2 . The

coal feed in slurry form enables the gasifier to operate at high pressure, 64 bars which permits an economy in the process volume and this high pressure is also favorable to physical absorption (Henry law). After a gas treatment where heat is recovered to produce medium and low-pressure steams, the CO₂ and H₂S are captured in the same unit. The acid gas containing more than 25% H₂S is sent to a Claus unit for sulphur recovery and the CO₂ is sent to a compression unit. The clean gas is expanded in order to recover electrical power and heated before dilution with waste nitrogen coming from the air separation unit.

We could notice that here (see figure 6) only 50% of the air needed by the ASU is extracted from the gas turbine; the remaining 50% is taken from ambient air using an ASU dedicated compressor. In fact, the optimum of integration depends on the type of gas turbine and specific studies should be performed for each gas turbine considered. Moreover, as the gasification is fed with slurry, the synthetic gas contains a relatively high amount of CO₂ compared to dry gasification. Therefore there is no more need of gas saturation with water or steam injection in the combustion chamber to meet low level of NO_x pollutant, the low heating value (LHV) of the diluted syngas being sufficiently low.

2.3. Performance in terms of energy of CO₂ capture

We have based our evaluation on the IGCC unit of Puertollano [8], [15] reevaluated under ISO conditions (1.013 bar, 15°C, 60% relative humidity) and using an international coal (16 % ash, 2 % moisture and 1 % sulfur) instead of the mixture of Puertollano local coal + petroleum coke. Under these ‘standard’ conditions, the net power of the plant is 326 MW and the LHV

efficiency is 44 %. Several physical and chemical absorption processes have been modeled with Aspen Plus™ software to compare their energy performance. However, to avoid too many power plant design modifications, the gasification pressure has been kept equal to 27 bars, although for physical solvents a higher pressure would have been more favorable. That is why after an initial selection, three processes were finally adopted and studied in detail: a physical absorption process by methanol, another physical absorption process, the Selexol process, in which the solvent is based on dimethylether polyethylene glycol (DMPEG), and a process using an activated amine-based chemical solvent, methyl-diethanolamine (MDEA).

In addition to the equipment required for CO₂ separation (absorption and desorption columns, pumps, heat exchangers, pressure reduction tanks, etc.), we also included in the process:

- a catalytic device for conversion of the CO into CO₂ ("shift conversion") upstream of the separation in order to increase the CO₂ content and thus improve the efficiency of the capture;
- a refrigeration system for the methanol process to maintain an optimum temperature of -30°C in the absorption column and a downstream recovery system to limit losses of the absorbent;
- a device to reduce the water content in the CO₂ produced to less than 20 ppm to prevent acid corrosion in the transport pipes;

- a 150 bar CO₂ compression station linked to a gas cooling system (final temperature < 40°C) in order to comply with the specifications of the CO₂ transport network.

The CO₂ absorption rate in the IGCC integrated methanol process has been varied from 77 to 88 mol %, with a CO conversion rate fixed at 90 mol %. Figure 7 shows that 85% CO₂ recovery seems to be a good compromise: above this recovery rate, the energy penalty grows quite steeply, while below 85% recovery rate the energy penalty decreases almost linearly. In fact, 85% was then chosen to compare the three processes integrated into the global IGCC system. This takes into account the efficiency of conversion of CO into CO₂ (90 %) and that of the separation of the CO₂ itself (approximately 95%). The efficiency loss shown in Figure 8 is calculated by the difference in efficiency of IGCC with and without capture divided by the efficiency of IGCC without capture.

The power output of the gas turbine was maintained nearly constant with the CO₂ capture operation by adding enough coal flow rate to the gasifier. The auxiliary electric consumption takes into account all the electric power needed by pumps and compressors, including the CO₂ inter-cooling compressor which delivers a CO₂ flux at 150 bar and 37°C, the solvent recycling pump, and the compressor for methanol refrigeration (see Figure 9). As can be seen in Figure 9, all the solvents have almost similar consumption for the CO₂ compression and for the standard auxiliaries (such as Air Separation Units and pumps and compressors of the units other than the CO₂ capture one). However, the chemical solvent shows a higher consumption due to the steam bleeding for solvent regeneration. This consumption was calculated by disconnecting the steam flux going from the combined cycle to the solvent regeneration column and calculating the difference in the power output when this flux is fully integrated.

Figure 8 shows the performance of the three solvents integrated into the IGCC, compared to the IGCC without capture. The comparison of the different energy balances is presented for 85% recovery of CO₂. The best energy performance is obtained with the methanol process although the performance of the other two systems is close. The efficiency of 'classical' IGCC with CO₂ capture using methanol is 33.5% and is therefore 10.5 points lower than that of the reference IGCC power plant, which represents a relative reduction of 24 %. The fact that physical and chemical processes show similar energy performance was expected as the 'classical' IGCC operates at relatively low pressure (27 bars) which delivers CO₂ to the capture system at a partial pressure around 8 bars. This is the starting point of chemical absorption saturation and the lower limit of physical absorption efficiency. With 'advanced' IGCC operating at a higher pressure (64 bars instead of 27 bars for 'classical' IGCC), the CO₂ capture using a physical solvent like methanol seems to be more interesting than the same operation in 'classical' IGCC because of high partial pressure of CO₂ in the former case. The efficiency loss is only 9.3 points (see Table 1) in 'advanced' IGCC whereas in 'classical' IGCC the efficiency drop is above 10 points. However, in the cases without CO₂ capture 'advanced' IGCC has lower efficiency than 'classical' IGCC. This is because 'advanced' IGCC uses feedstock in slurry form which should contain a maximum of 64% solids otherwise the compression operation to 64 bars could be risky because of increasing viscosity with solid contents. Therefore there is a high amount of water to evaporate in the slurry gasifier, which leads to higher production of oxygen by the ASU, leading to higher electrical consumption by this latter compared to the ASU of 'classical' IGCC. This consumption by the ASU in 'advanced' IGCC is greater than the lack of electricity production due to the steam

consumption needed in ‘classical’ IGCC. However the benefit of high-pressure gasification remains in capital cost of equipment as can be seen in the next section.

3. The cost of CO₂ capture

The cost of construction of the ‘classical’ IGCC (without capture) was established on the basis of the economic data of Puertollano, eliminating the redundant equipment and redimensioning the devices on the basis of ISO conditions and the use of an international standard coal. The following are included: the costs of supply, erection and commissioning of the different devices and ancillary infrastructure (roads, offices, parking area, lighting, etc.) and a provision for contingencies and project management charges (owner’s cost).

The construction costs of the devices associated with CO₂ capture were calculated on the basis of an investigation entrusted to Technip concerning the processes with methanol and activated MDEA, including the system for dehydration of the flow of CO₂ produced, the methanol recovery system and the 150 bars CO₂ compression station. The construction cost of the Selexol process was calculated from information supplied by UOP, the licensor for this type of process.

The cost of ‘advanced’ IGCC was taken from a detailed study published by the Green House Gas division of the International Energy Agency [16].

The investment costs for all cases with and without capture were obtained by adding to the construction costs the interest during construction (calculated for a construction period of four years), the preproduction costs and a contingency fund. Table 1 shows the relative investment

costs, taken ‘classical’ IGCC as reference, for an IGCC power plant with and without a CO₂ capture device. We note that the ‘advanced’ IGCC shows lower specific cost relatively to ‘classical’ IGCC thanks to higher pressure of the process and probably also thanks to bigger scale. The transport and storage costs are detailed in reference [16].

In the end (see Table 1), the absolute investment cost of a ‘classical’ IGCC power plant would increase by 33% if a CO₂ capture device were to be included (methanol or MDEA), however the specific investment cost is increased by higher value, 53%, due to efficiency decrease induced by CO₂ capture option. For ‘advanced’ IGCC without capture the specific investment cost is lower by 14% than the one of ‘classical’ IGCC without capture, and for ‘advanced’ IGCC with capture one should add approximately 28% to ‘classical’ IGCC without capture and 49% to the case of ‘advanced’ IGCC without capture.

If we consider only the construction costs, Figure 10 shows that in the case of the process with methanol the CO₂ separation system represents 15% of the total cost of the equipment and that the shift conversion and the CO₂ compression each represent 4% of the total, which brings the proportion of the cost of capture to 23% of the construction cost of the power plant.

Recent work [18] compared the estimate of the cost obtained by the authors with estimate available in the literature. The different cost estimates were updated and levelled to late 2004 US\$ levels and the technologies studied are coal-fired power plant, IGCC, and GTCC using amine scrubbing technology for CO₂ capture. Their results show a good agreement of the newly developed model with the previous studies. Analysis of the data series provided three power plant capacity ranges (2000–1500, 1500–900 and 900–300 MWe) in which the patterns

of CO₂ avoidance costs become steeper. Our results are in agreement with those provided in [18] in particular with regard to the new IGCC.

4. Conclusion

The integration of CO₂ capture in a complete and detailed IGCC power station simulation model has been studied in order to calculate the final efficiency. We chose for this study a detailed representation of the process and the related thermodynamic parameters in order to represent the processes as realistically as possible. An important aspect of CO₂ capture is the auxiliary amount of energy required by using such systems. This energy consumption reduces the overall efficiency of power generation, typically by 24%, which is a substantial price to pay for capturing CO₂. One attraction of the methanol process is that the required energy consumption is moderate for this operation compared to chemical absorption. There is continuous research to reduce energy consumption for the overall process. The use of the new technologies such as gasification under high pressure can lead to better performance for physical solvents even if the consumption induced by high water content of the slurry leads to a higher energy penalty even for the case without CO₂ capture. Also using gas turbines operating with high turbine inlet temperature and therefore presenting a higher efficiency (60% in a combined cycle instead of 53% used in 'classical' IGCC) will increase the power production and the electric net efficiency, which is a complimentary way to reduce fossil fuel consumption and therefore the CO₂ emission.

This investigation into the overall cost per kWh generated by a coal-fired IGCC power plant with CO₂ capture shows that the integration of the CO₂ capture system must be optimized

carefully (choice of the absorbent, operating pressure, etc.) to limit the loss of efficiency, which has a severe impact on the generating cost per kWh.

Having stated these reservations, the results show that the basic generating cost from 'classical' IGCC with capture would increase by 39% relatively to 'classical' IGCC without capture. The incremental production cost induced by CO₂ capture for 'advanced' IGCC is only 28% which leads to a relatively lower cost per tonne of CO₂ avoided which is 82% lower in the case of 'advanced' IGCC than in 'classical' IGCC.

Even though the incremental costs are substantial, they do not appear to constitute in themselves an obstacle to the development of the capture / storage of CO₂ if financial mechanisms are established to combat global warming. For example, in 1996 Statoil created a storage facility in the Sleipner field in order to avoid a Norwegian tax of about \$ 50 / tonne on offshore releases of CO₂ [19].

Absolute values of cost estimate are not given here and those given elsewhere [17] should be viewed with caution as they are made to an accuracy of $\pm 30\%$. Moreover, metal market and contract prices have been rising for two years and this will probably lead to a much higher cost for the power plant if based on 2007euro values but will probably not lead to significant change in differential comparisons between the different options. In the other hand, these values could also fall in the medium / long term as a function of technical progress on process efficiency and capture technologies.

Acknowledgments

The authors wish to thank the ADEME 'Agence de l'Environnement et de la Maîtrise de l'Energie' the French public environmental agency

ACCEPTED MANUSCRIPT

References

- [1] C. Philibert, J. Pershing, Beyond Kyoto: energy dynamics and climate stabilisation, IEA (International Energy Agency) Publications, 9, rue de la Fédération, 75739 Paris Cedex 15, France (2002).
- [2] P. Chiesa, S. Consonni, Shift reactors and physical absorption for Low-CO₂ emission IGCCs, *Journal of Engineering for Gas Turbines and Power* 121 (2) (1999) 295-305.
- [3] R. Pruschek, G. Oeljeklaus, V. Brand, G. Haupt, G. Zimmermann, J.S. Ribberink, Combined cycle power plant with integrated coal gasification, CO shift and CO₂ washing, *Energy Conversion and Management* 36 (6-9) (1995) 797-800.
- [4] P. Chiesa, G. Lozza, CO₂ emission abatement in IGCC power plants by semi closed cycles: Part A-with oxygen-blown combustion, *Journal of Engineering for Gas Turbines and Power* 121(4) (1999) 635–641.
- [5] P. Chiesa, G. Lozza, CO₂ emissions abatement in IGCC power plants : Part B with air blown combustion and CO₂ physical absorption, *Journal of Engineering for Gas Turbines and Power* 121(4) (1999) 642-648.
- [6] G. Ordorica-Garcia, P. Douglas, E. Croiset, L. Zheng, Technoeconomic evaluation of IGCC power plants for CO₂ avoidance, *Energy Conversion and Management* 47 (2006) 2250–2259.
- [7] R. C. Sekar, J. E. Parsons, H. J. Herzog, H. D. Jacoby, Future carbon regulations and current investments in alternative coal-fired power plant technologies, *Energy Policy* 35 (2007) 1064–1074.
- [8] M. Aineto , A. Acosta, J. Ma. Rincon , M. Romero, Thermal expansion of slag and fly ash

from coal gasification in IGCC power plant, *Fuel* 85 (2006) 2352–2358.

[9] F. Murietta-Guevara, E. Rebolledo-Libreros, A. Trejo, Solubility of carbon dioxide in binary mixtures of N-Methyl- Pyrrolidone with alkanolamines, *Journal of Chemical Engineering Data* 37 (1992) 4-7.

[10] A. Henni, A. Mather, Solubility of carbon dioxide in methyldiethanolamine methanol and water, *Journal of Chemical Engineering Data* 40 (1995) 493-495.

[11] C. Descamps, Etude de la captation du CO₂ par absorption physique dans les systèmes de production d'électricité basés sur la gazéification du charbon intégrée à un cycle combiné, PhD thesis, Ecole des Mines, Paris, 2004.

[12] T. Holderbaum, J. Gmehling, PSRK: A contribution equation of state based on unifac, *Fluid Phase Equilibria* 70 (1991) 251-265.

[13] J. H. Hong, R. Kobayashi, Vapor liquid equilibrium studies for the carbon dioxide-methanol system, *Fluid Phase Equilibria* 41 (1988) 269-276.

[14] K. Suzuki, H. Sue, M. Itou, R. Smith, H. Inomata, K. Arai, S. Saito, Isothermal vapor-liquid equilibrium data for binary systems at high pressures, *Journal of Chemical Engineering Data* 35 (1990) 63-66.

[15] O. Font, X. Querol, F. Plana, P. Coca, S. Burgos, F. Garcia-Pena, Condensing species from flue gas in Puertollano gasification power plant, Spain, *Fuel* 85 (2006) 2229–2242.

[16] IEA (International Energy Agency)-GHG, Potential improvement in gasification combined cycle power generation with CO₂ capture, report number PH4/19, May 2003.

[17] P. Jaud, R. Gros-Bonnivard, M. Kanniche, E. Amantini, T. Manai, C. Bouallou, C. Descamps, Technico-economic feasibility study of CO₂ capture, transport and geo-

sequestration: a case study for France, Proceedings of the Seventh Greenhouse Gas Control Technologies (GHGT-7) Conference, Vancouver, Canada. International Energy Association (IEA), Greenhouse Gas R&D Programme, 2004.

[18] J. Klemeš, I. Bulatov, T. Cockerill, Techno-economic modelling and cost functions of CO₂ capture processes, Computers & Chemical Engineering, In Press, Available online 20 July 2006.

[19] B. McKee, Solutions for the 21st century: Zero emissions technologies for fossil fuels, IEA (International Energy Agency) Publications, Paris, France, 2002.

ACCEPTED MANUSCRIPT

Figure captions

Fig. 1. : Typical absorption process

Fig. 2. : Compression unit including methanol recovery and TEG dehydration system

Fig. 3. : Methanol process for CO₂ capture including distillation column for methanol recovery

Fig. 4. : Reboiler duty for six solvents

Fig. 5. : 'Classical' dry coal IGCC system with CO₂ capture

Fig. 6. : 'Advanced' coal IGCC system with CO₂ capture

Fig. 7. : Efficiency loss versus capture rate

Fig. 8. : 'Classical' IGCC net efficiency with and w/o capture

Fig. 9. : Auxiliaries consumption relative to the gross power plant output

Fig. 10. : Breakdown of the construction costs of the IGCC with capture by methanol

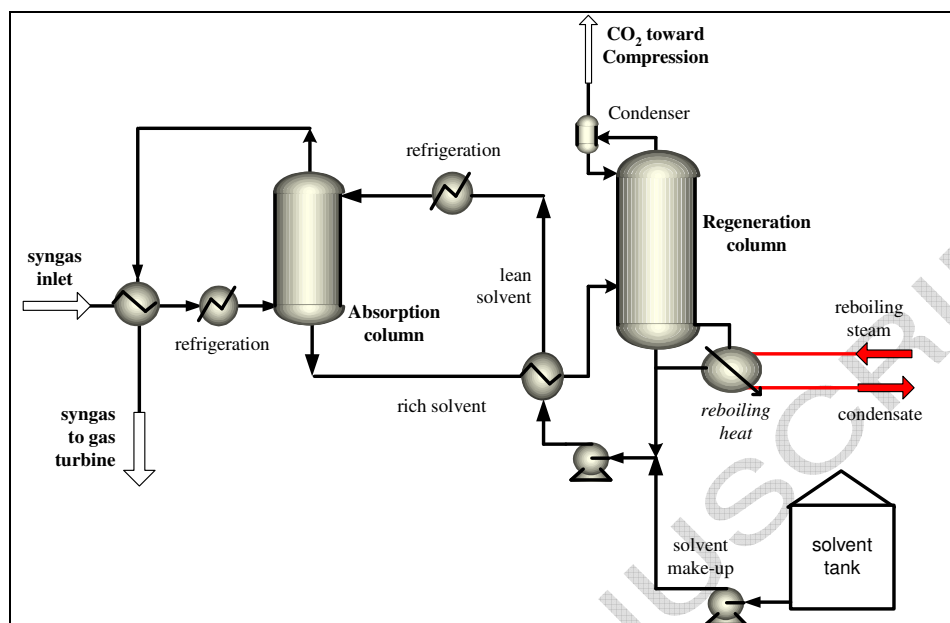

Fig. 1. : Typical absorption process

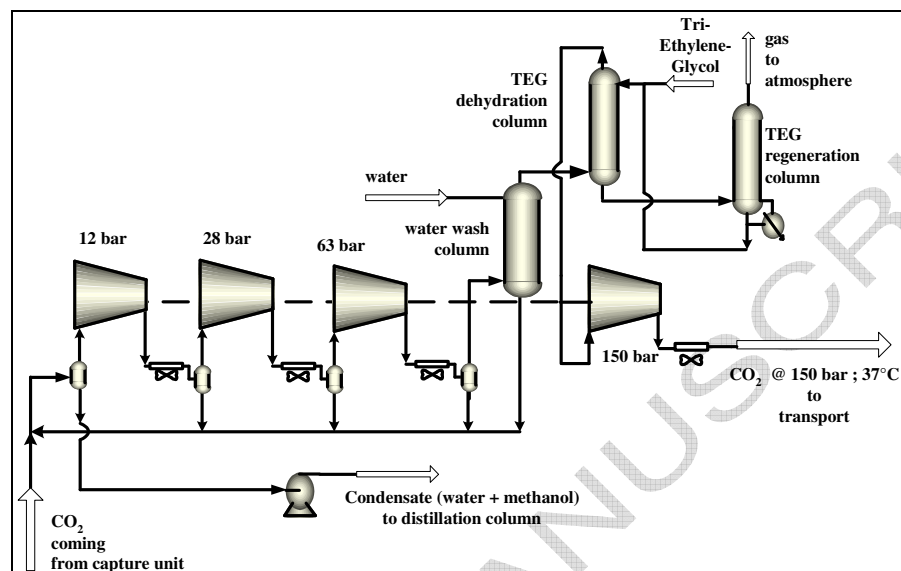

Fig. 2. : Compression unit including methanol recovery and TEG dehydration system

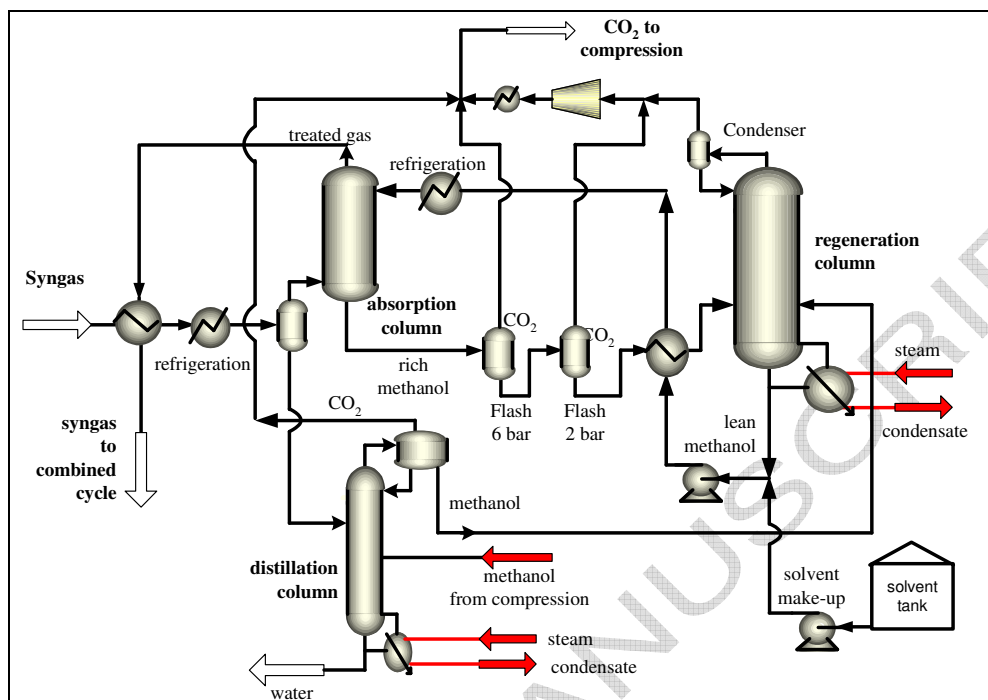

Fig. 3. : Methanol process for CO₂ capture including distillation column for methanol recovery

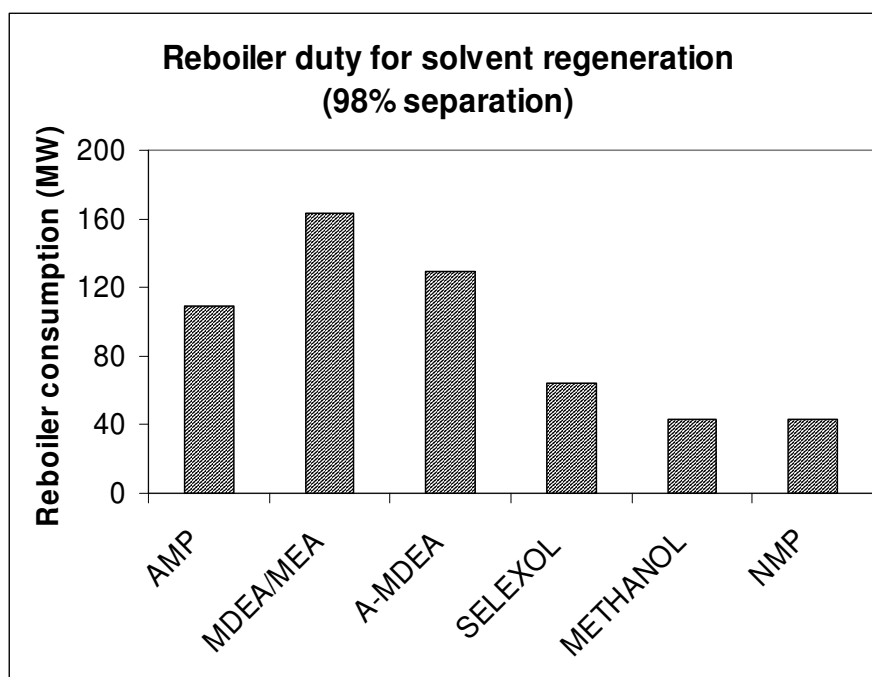

Fig. 4. : Reboiler duty for six solvents

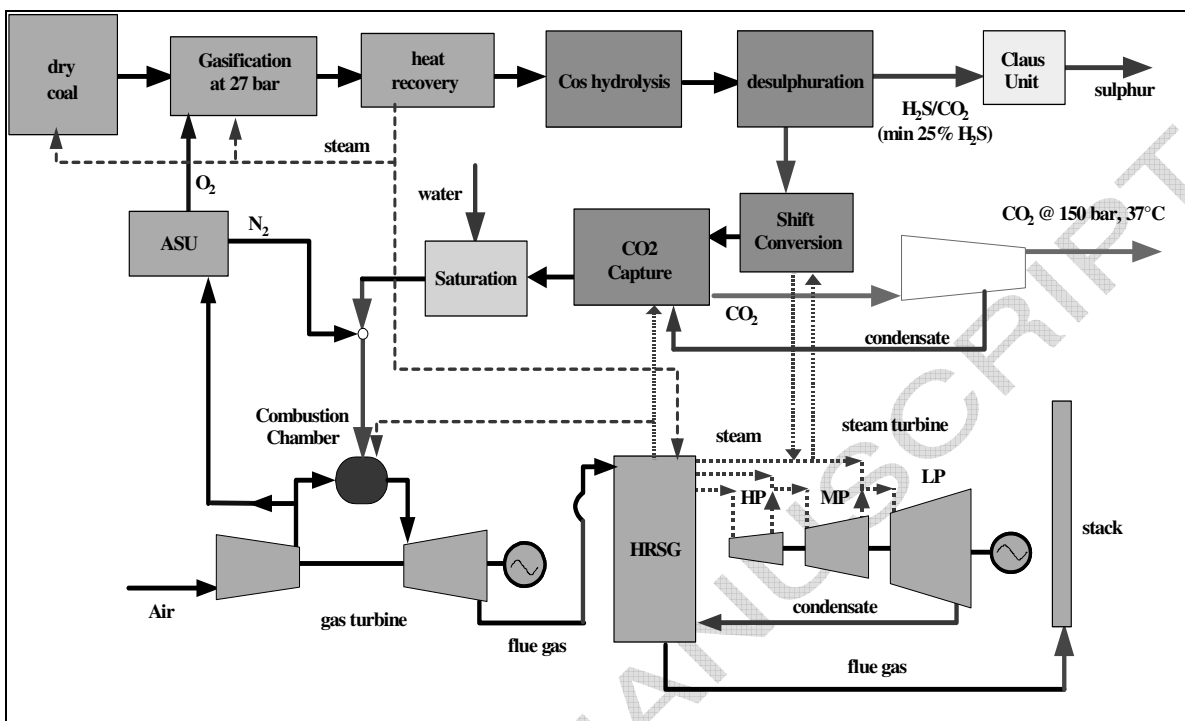

Fig. 5. : 'Classical' dry coal IGCC system with CO₂ capture

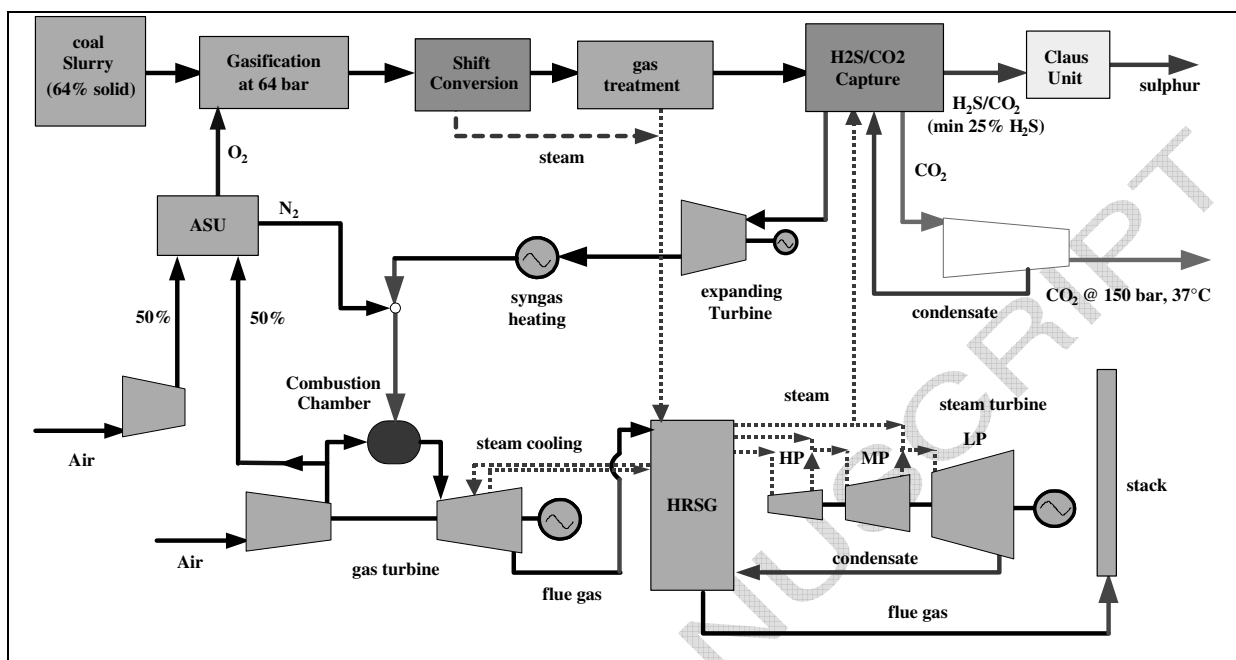

Fig. 6. : 'Advanced' coal IGCC system with CO₂ capture

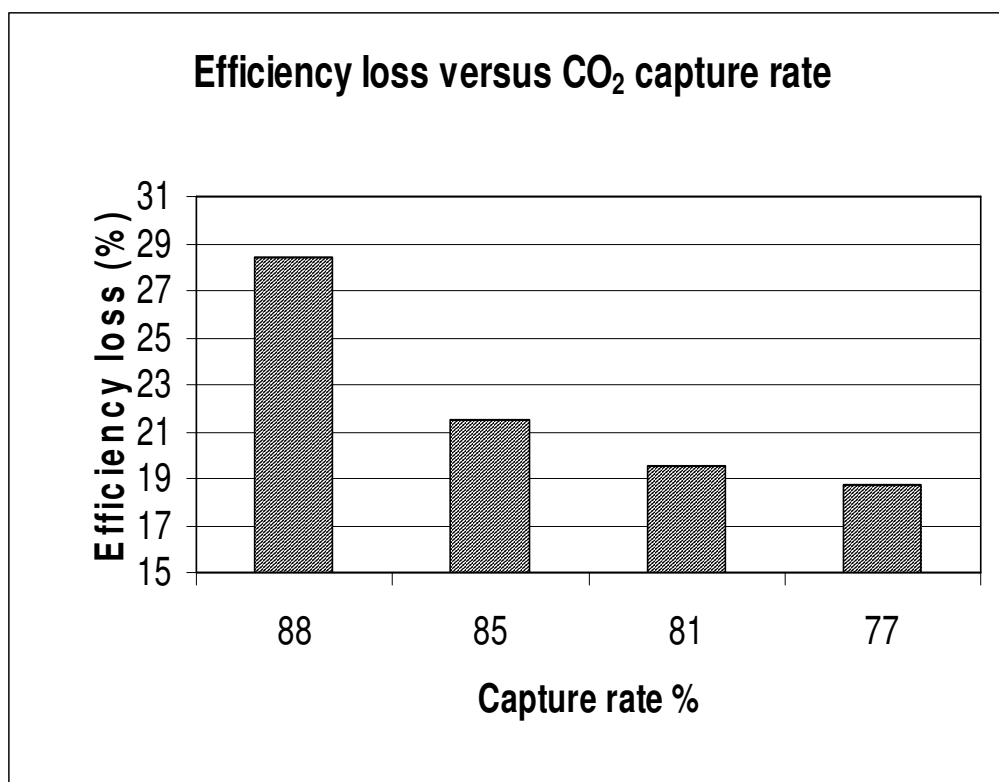

Fig. 7. : Efficiency loss versus capture rate

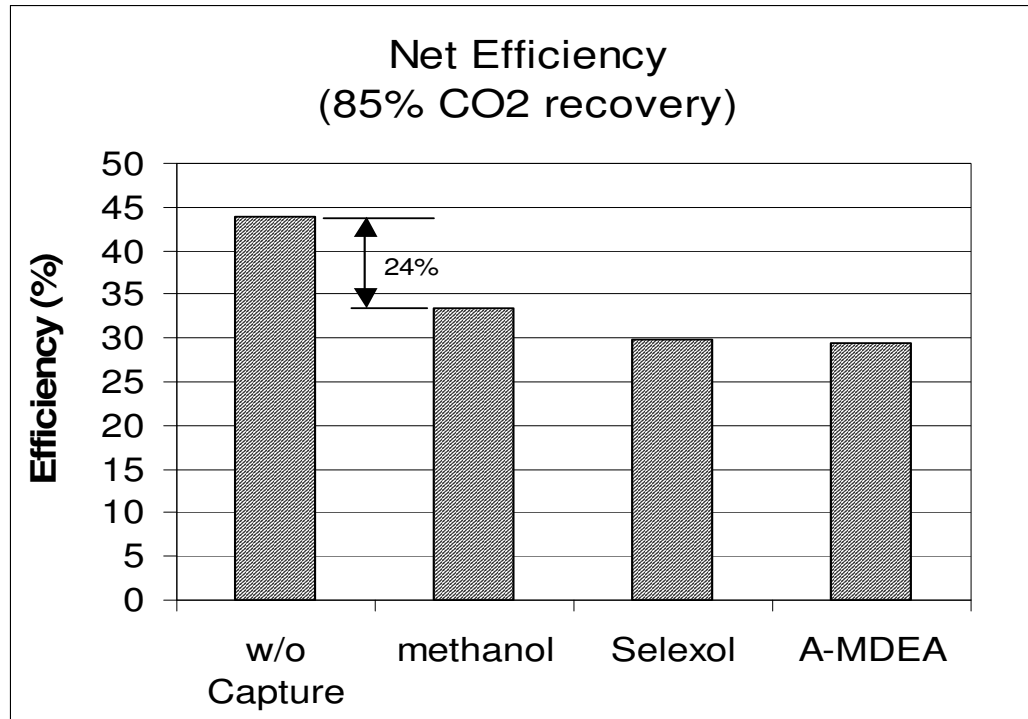

Fig. 8. : 'Classical' IGCC net efficiency with and w/o capture

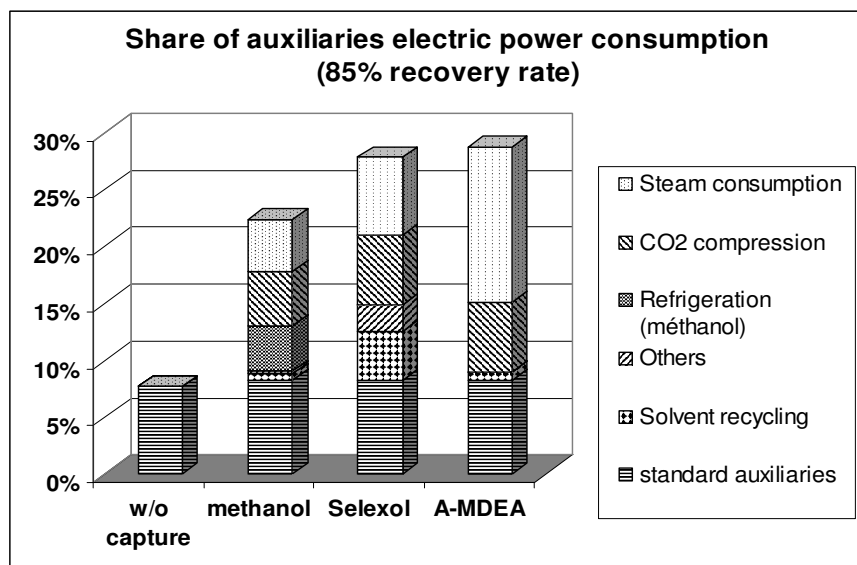

Fig. 9. : Auxiliaries consumption relative to the gross power plant output

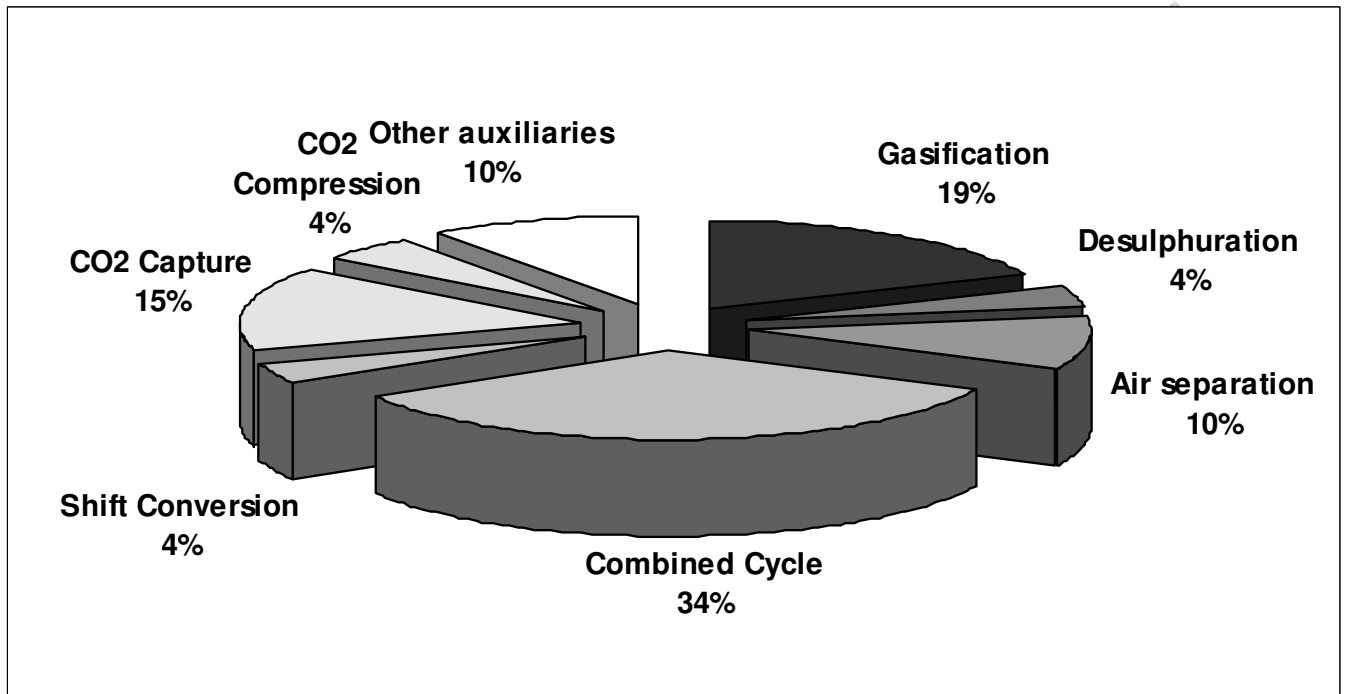

Fig. 10. : Breakdown of the construction costs of the IGCC with capture by methanol

ACCEPTED

Table 1: Comparison between ‘classical’ and ‘advanced’ IGCC with and without capture (methanol process for 85% of CO₂ capture – 8% interest rate for economic evaluation)

	‘Classical’ IGCC without capture	‘Classical’ IGCC with capture	‘Advanced’ IGCC without capture	‘Advanced’ IGCC with capture
Input thermal power (MWth)	98	112	349	378
Gross power output (MWe)	353	347	1223	1184
Net power output (MWe)	326	285	1057	893
Net efficiency (%)	43.9	33.5	42.3	33
Emitted CO ₂ (kg/kWh)	0.735	0.141	0.777	0.149
Avoided CO ₂ (kg/kWh)		0.594		0.586
Relative equipment cost *	100	133	280	351
Relative specific investment cost*	100	153	86	128
Relative production cost*	100	139	96	128
Relative cost of avoided CO ₂ *		100		82

* all the costs are expressed relatively to ‘classical’ IGCC without capture which is taken as reference