



HAL
open science

The use of Self Interaction Chromatography in stable formulation and crystallization of proteins

Kedar Deshpande, Tangir Ahamed, Joop H. ter Horst, Peter T. Jansens, Luuk A.M. van Der Wielen, Marcel Ottens

► **To cite this version:**

Kedar Deshpande, Tangir Ahamed, Joop H. ter Horst, Peter T. Jansens, Luuk A.M. van Der Wielen, et al.. The use of Self Interaction Chromatography in stable formulation and crystallization of proteins. *Biotechnology Journal*, 2009, 4 (9), pp.1266. 10.1002/biot.200800226 . hal-00498911

HAL Id: hal-00498911

<https://hal.science/hal-00498911>

Submitted on 9 Jul 2010

HAL is a multi-disciplinary open access archive for the deposit and dissemination of scientific research documents, whether they are published or not. The documents may come from teaching and research institutions in France or abroad, or from public or private research centers.

L'archive ouverte pluridisciplinaire **HAL**, est destinée au dépôt et à la diffusion de documents scientifiques de niveau recherche, publiés ou non, émanant des établissements d'enseignement et de recherche français ou étrangers, des laboratoires publics ou privés.



The use of Self Interaction Chromatography in stable formulation and crystallization of proteins



Journal:	<i>Biotechnology Journal</i>
Manuscript ID:	BIOT.200800226.R1
Wiley - Manuscript type:	Review
Date Submitted by the Author:	11-Mar-2009
Complete List of Authors:	Deshpande, Kedar; Delft University of Technology, Biotechnology Ahamed, Tangir; Delft University of Technology, Biotechnology ter Horst, Joop; Delft University of Technology, Process & Energy Laboratory Jansens, Peter; Delft University of Technology, Process & Energy Laboratory van der Wielen, Luuk; Delft University of Technology, Biotechnology Ottens, Marcel; Delft University of Technology, Biotechnology
Primary Keywords:	
Secondary Keywords:	
Keywords:	Predictive protein crystallization, protein phase behavior, miniaturization



Review

The use of self-interaction chromatography in stable formulation and crystallization of proteins

Kedar S. Deshpande^{1,2}, Tangir Ahamed^{1,*}, Joop H. ter Horst², Peter J. Jansens², L. A.

M. van der Wielen¹ and Marcel Ottens¹

¹ Department of Biotechnology, Delft University of Technology, Delft, The Netherlands

² Process and Energy Laboratory, Delft University of Technology, Delft, The Netherlands

Correspondence: Dr. Marcel Ottens, Department of Biotechnology, Delft University of Technology, Julianalaan 67, 2628BC Delft, The Netherlands

E-mail: m.ottens@tudelft.nl

Fax: +31-15-278-2355

* *Current address:* SynCo Bio Partners B.V., Paasheuvelweg 30, 1105 BJ, Amsterdam, The Netherlands

Keywords: Miniaturization / Predictive protein crystallization / Protein phase behavior / Self-interaction chromatography

Abbreviations: B_{22} , osmotic second virial coefficient; SIC, self-interaction chromatography; SLS, static light scattering

This paper reviews the basic principles of the recently developed self-interaction chromatographic (SIC) technique with regard to protein solution stability and protein crystallization. It gives experimental protocols for both normal-scale and micro-scale SIC experiments, and reviews recent developments and current application of this novel technique in the biopharmaceutical area. This paper aims to be a benchmark in the further proliferation of this highly effective and fast technology for the rational

Deleted: self

Deleted: Julianalaan 67, 2628BC

Deleted: .

Deleted: &

Formatted: Font: Not Italic

Deleted: Leeghwaterstraat 44, 2628CA

Deleted: .

Deleted: ¶

Deleted: ¶

Deleted: .

Deleted: DLS, dynamic light scattering; LLS, laser light scattering; mAbs, monoclonal antibodies; MO, micro-osmometry; SAXS, small angle x-ray scattering; SEC, size exclusion chromatography;

Formatted: Font: Not Bold

Deleted: .

Deleted: .

Deleted: ; UV, ultraviolet

Deleted: in

Deleted: normal

Deleted: micro

1
2 design of stable aqueous formulations of therapeutic proteins and the determination
3
4 of solution conditions favoring protein crystallization.
5
6
7
8

9 10 **1 Introduction**

11
12
13
14 The use of proteins in industrial and pharmaceutical applications has become
15 increasingly common. For example, many monoclonal antibodies (mAbs) are
16 currently in the pipeline of biopharmaceutical drug development due to their high
17 binding strengths and specificities. However, antibodies are susceptible to
18 aggregation and degradation at elevated concentration. At the higher concentrations
19 currently reached in industrial production titers, proteins tend to aggregate and
20 usually lose their potency. Protein drug formulations containing aggregates are
21 known to cause an immunogenetic response and cannot be used. Preparation of very
22 high concentration of these antibodies at a very low volume per dose is critical.
23
24

Deleted: o

25
26 Therefore, predicting or quickly measuring aggregation behavior is paramount for
27 proper formulation development of protein-based biopharmaceuticals.
28
29

Deleted: protein

30
31 Modern biochemistry relies on the structural information provided by protein
32 crystallization to understand fundamental mechanisms of action. Knowledge of
33 protein solubility is crucial for understanding the crystal growth and crystallization
34 process of proteins. In the native state, proteins can be crystallized by the addition of
35 a precipitating agent, which may for example be a neutral salt, a high molecular
36 weight polymer such as PEG, or a small organic compound such as
37 methylpentanediol [1, 2]. The addition of salts, like NaCl, screens the protein
38 charges, progressively leading to protein-protein interactions, and eventually to
39
40
41
42
43
44
45
46
47
48
49

Deleted: key

Deleted: to

Deleted: attractive

Deleted: ,

Deleted: leading

1
2 protein crystallization [3]. Growing evidence suggests that protein crystallization can
3
4 be understood in terms of phase transition in a system of weakly attractive particles

5
6 [4]. Controlling these attractions is essential for growing the crystals. However, a
7
8 *priori* prediction of protein pair potentials governing these attractions is a difficult
9
10 task and remains a significant challenge in determining crystallization conditions.

11
12 Experimental methods for characterizing the influence of solution conditions (pH,
13
14 ionic strength, temperature, *etc.*) on the pair potential would provide the
15
16 experimentalist with the opportunity to make predictions about how these variables
17
18 will influence solubility, phase behavior and eventual crystallization.

19
20 Protein-protein interaction phenomena occur throughout the range of pharmaceutical
21
22 protein-processing environments: inclusion body formation in fermentation
23
24 operations; aggregation as a competitive reaction to refolding; precipitation steps;
25
26 and inadvertent crossings of solubility thresholds in purification and finishing

27
28 processes [5]. Underlying all of these areas is physical protein stability. Physical
29
30 protein stability can roughly be defined as the inability for a protein to form protein
31
32 aggregates, protein crystals or an amorphous protein in a stored solution. Physical
33
34 stability differs from chemical stability in that no chemical modifications of the
35
36 protein or peptide occur. Measuring realistic protein solubility is hampered by the

37
38 ability of proteins to supersaturate. Supersaturated solutions generally are not
39
40 physically stable over storage periods of months or years. Physical protein stability is
41
42 a particularly relevant issue today in the pharmaceutical field, as indicated above, and
43
44 will continue to gain more importance as the number of therapeutic protein products
45
46 in development increases.

47
48 Protein-protein self-interactions under varying conditions are important, and
49
50 screening tools are being developed. One of the parameters capturing protein-protein
51
52 self-interactions is the osmotic second virial coefficient (B_{22}). B_{22} can be easily

Deleted: of

Deleted: key

Deleted: to

Formatted: Font: Italic

Deleted: for

Deleted: ing

Deleted: ly

Deleted: protein

Deleted: is

Deleted: ent

Deleted: s

Deleted: This

1
2 screened using self-interaction chromatography (SIC). The aim of this paper is to
3
4 review the important factors governing protein solution stability, and protein
5
6 crystallization propensity, and to describe the novel SIC methodology and its
7
8 application in protein stability and crystallization studies. This is exemplified by a
9
10 detailed description of the methodology and some recent developments in
11
12 miniaturizing the method. Finally, some examples from industry are given utilizing
13
14 this approach.
15
16
17

Deleted: ,

Deleted: will be

Deleted: will be

Deleted: The o

2 Osmotic second virial coefficient (B_{22})

2.1 History of B_{22} as a predictor of crystallization conditions

26
27 Dynamic laser scattering has been used to study the change in the state of aggregation
28
29 of protein solutions during nucleation and post-nucleation growth [6] and also to
30
31 estimate the particle-size distribution in the protein aggregate mixture [7]. Results
32
33 from these types of experiments have been used to postulate the existence of a critical
34
35 nucleus to sustain growth [8,9] and to differentiate between the formation of craggs
36
37 (aggregates which eventually result in protein crystals) and praggs (aggregates which
38
39 eventually result in amorphous protein precipitates) [10]. Light scattering to
40
41 determine aggregation behavior is experimentally difficult, and time consuming, and
42
43 relatively large amounts of protein are needed. Therefore, there is still a genuine
44
45 interest among protein crystallographers for the development of a quantitative pre-
46
47 crystallization assay as a way to test protein solutions for the likelihood for either
48
49 crystal or amorphous precipitate formation. Having a universal predictor will allow
50
51
52
53
54
55
56
57
58
59
60

Deleted: (DLS)

Deleted: ,

Deleted: -

Deleted: on

crystallographers to 'fine-tune' existing crystallization conditions or discover new solution conditions to crystallize difficult proteins.

Deleted: 'fine

George and Wilson [11], via light scattering experiments, proposed the osmotic second virial coefficient (B_{22}) as a predictor for protein crystallization and showed a

Formatted: Font: Italic

Deleted: ,

correlation between protein crystallizability and B_{22} . Their work demonstrated that

small, spherical proteins crystallize in conditions under which B_{22} becomes slightly

Formatted: Not Superscript/ Subscript

Deleted: where

Deleted: the second osmotic virial coefficient

negative, indicating net attractive interactions between protein molecules [11]. An

increase in B_{22} indicated a shift toward favorable protein–solvent interaction, whereas

a decrease in B_{22} indicated a shift toward protein self-interaction [12]. Solution

Deleted: Thereafter,

Deleted: s

conditions conducive to crystallization have been shown to correspond to slightly

negative values of B_{22} [11, 13]. Such conditions denote weak attraction, whereas

stronger attraction (more negative B_{22}) was found to correlate with amorphous

precipitation. Rosenbaum et al. [14] extended the correlation by showing that the

Deleted: et al

measured virial coefficients could be used to predict solubility within the framework

of the sticky hard sphere model, suggesting that short-range attraction is dominant in

governing phase behavior. The empirical relationship between the second virial

coefficient and solubility of proteins was well supported by complementary studies

on a molecular basis [14–16] as well as through the classical thermodynamic

Deleted: -

approach [17]. Velev et al. [18] extended the hypothesis and investigated the virial

Deleted: et al

coefficients of lysozyme and chymotrypsinogen by both static light scattering (SLS)

and small angle neutron scattering.

Deleted: SANS

Over the years, B_{22} has been correlated to physical protein stability; that is, solubility

[15, 19, 20], crystallization [11–13], and aggregation [21–23] by explicitly

Deleted: -

Deleted: -

accounting for the same interactions that regulate protein phase behavior [14, 16].

For example, Ahamed et al. [24] generated a universal protein phase diagram in

Deleted: et al

terms of B_{22} as a pre-scan for suitable crystallization conditions of the intact mAb

Deleted: monoclonal antibody

1 IDEC152. This link between molecular interactions in terms of B_{22} and protein
 2 crystallization thus offered hope that screening the second virial coefficient values
 3
 4
 5
 6
 7
 8
 9
 10
 11
 12
 13
 14
 15
 16
 17
 18
 19
 20
 21
 22
 23
 24
 25
 26
 27
 28
 29
 30
 31
 32
 33
 34
 35
 36
 37
 38
 39
 40
 41
 42
 43
 44
 45
 46
 47
 48
 49
 50
 51
 52
 53
 54
 55
 56
 57
 58
 59
 60

2.2 Measurement and application of B_{22}

Despite the potential utility of B_{22} , it was rarely used in biotechnology,
 pharmaceuticals, and structural biology because the main techniques for
 measurement were slow, sample intensive, and required significant expertise. Over
 the years, B_{22} has been measured by neutron scattering [18], sedimentation
 equilibrium [25], x-ray scattering [26], and osmometry [27]. However, both light (or
 dynamic) scattering and osmometry suffer from the disadvantage of requiring a
 relatively large amount of protein (~100 mg) for each desired solution condition.

Further, with these methods it is difficult to measure interactions between different
 proteins because the second virial coefficient of individual proteins must be
 determined before making measurements on the mixture. Patro and Przybycien [28],
 described SIC as a new protein characterization technique, which overcame both of
 these disadvantages. Tessier *et al.* [29] elaborated and further refined this novel
 method of measuring B_{22} using the SIC technique. A comparison between
 conventional B_{22} measuring techniques and SIC is given in Table 1.

((Table 1))

According to Table 1, the SIC methodology has a distinct advantage over traditional
 methods [micro-osmometry (MO), SLS, size exclusion chromatography (SEC), *etc.*]
 used to measure B_{22} through higher accuracy, lower protein consumption, simple
 automation and the potential for miniaturization. Miniaturized SIC (micro-SIC),

Formatted: Not Superscript/
Subscript

Formatted: Not Superscript/
Subscript

Deleted: 100

Deleted: self-interaction
chromatography (

Deleted:)

Deleted: et al

Deleted: by

Deleted: table

Deleted: (

Formatted: Font: Italic

Deleted: .)

Deleted: by accounting for

Deleted: , on the other hand,

1 requires an order of magnitude less protein (≤ 0.002 mg per B_{22} value), has rapid
2 measurement time scales (< 5 min per B_{22} value) and thereby the possibility to
3 generate hundreds of B_{22} measurements per day. It has to be noted that the minimum
4 amount of protein (Table 1) required in MO, SLS and SEC are calculated on the
5 basis of minimum sample volume that can be handled by the measuring instrument.
6
7 In case of SIC, as protein is immobilized on column wall, the retention of protein
8 depends on the injected concentration. It has been shown that at $\geq 33\%$ surface
9 coverage, multibody interactions give inconsistent B_{22} values and experiments
10 suggest a surface coverage of 15% to be adequate for optimum coupling [30]. Hence,
11 the minimum amount of injectable protein on a SIC column depends on the number
12 of protein molecules immobilized inside the chromatography column with an optimal
13 surface coverage. There has been a substantial decrease in the amount of injectable
14 protein needed with the advent of the micro-SIC platform. The reproducibility of SIC
15 is good, but since all the measuring techniques have an inherent inaccuracy, it is
16 difficult to state that the SIC technique is the most accurate one. Nevertheless, the
17 measurements from SIC and micro-SIC are reproducible and results fall well within
18 the scattered literature data set.

19 Experimental evidence of the suitability of SIC for measuring B_{22} for numerous
20 proteins, such as BSA [29], myoglobin [29], lysozyme [30–34], equine serum
21 albumin [32], chymotrypsinogen [34] and ribonuclease A [35] has been well
22 documented over the years. The reproducibility along with the accuracy limit of B_{22}
23 for lysozyme was found to be superior using SIC methodology (also known as
24 quantitative affinity chromatography [33]) in comparison to other traditional
25 techniques [30]. A modified form of SIC, referred to as cross-interaction
26 chromatography, was also used to study weak protein interactions (B_{23}) between
27 unlike protein pairs such as BSA/lysozyme [36, 37], ovalbumin/lysozyme [36] and
28
29
30
31
32
33
34
35
36
37
38
39
40
41
42
43
44
45
46
47
48
49
50
51
52
53
54
55
56
57
58
59
60

Deleted:

Deleted: table1

Deleted:

Deleted: -

1 lysozyme/ α -chymotrypsinogen [37]. Payne *et al.* [38] extended the use of SIC for
2
3 measuring the B_{22} of a 36-amino acid therapeutic peptide, Enfuvirtide. Valente *et al.*
4
5 [39] recently demonstrated the use of SIC as a rational formulation screening tool to
6
7 characterize physical protein stability of an industrially relevant enzyme,
8

Deleted: et al

Deleted: et al

Deleted: for

9
10 *Pseudomonas* amylase. Furthermore, Kornmann *et al.* [40] recently showed the use
11
12 of SIC to significantly speed up (by months) their protein formulation shelf-life
13
14 stability studies of Fc fusion proteins and mAbs. These recent observations showed
15
16 the suitability of measuring the osmotic second virial coefficient by SIC to predict
17
18 crystallization conditions for proteins. Currently, the B_{22} screening method is being
19
20 extended to become a rational approach to find solution conditions for crystallizing
21
22 large molecules that have not yet been crystallized.
23

Deleted: et al

Deleted: shelf

Deleted: by months

Deleted: yet

24 In just over a decade, SIC technique has developed from a qualitative protein
25
26 purification [41, 42] and formulation screening approach [28] to a viable method for
27
28 quantitatively assessing physical protein stability with applications to rational protein
29
30 crystallization [34, 42, 43] and macromolecular formulation development [44]. The
31
32 SIC methodology not only exploits the specificity of protein-protein interactions that
33
34 are common to protein aggregates, but also enables rapid screening of protein
35
36 formulation additives as physical stabilizers against aggregation. The sensitivity of
37
38 the SIC technique and the ease of operation and automation makes it very attractive
39
40 as a formulation tool, a convenient way to probe protein-protein interaction sites in
41
42 solutions, and a convenient means to study protein self-association in solutions.
43

Deleted: were

Deleted: as well as

44 Current applications and views on evaluating protein self-interaction through B_{22} ,
45
46 along with technological advances and direct comparison between experimental
47
48 approaches, have been summarized in recent reviews [30, 42].
49
50
51
52
53
54
55
56
57
58
59
60

2.3 Principle of SIC

In traditional liquid column chromatography, the ligand of interest is immobilized on a chromatographic support, a front of ligate in a suitable solution is passed over the stationary phase, and the column effluent is monitored for ligate breakthrough. The retention time reflects the average strength of the interaction. SIC is an affinity chromatographic technique in which the target protein serves as both the chromatographic ligand and ligate [28]. The SIC approach involves covalently immobilizing protein on chromatographic particles, packing the particles into a column, and measuring the retention time of a pulse of the same protein injected into the column (Fig. 1).

((Figure 1))

The relative retention of the protein pulse provides a measure of the average protein-protein interactions. The retention pattern obtained from an SIC run can be used to calculate the parameter B_{22} . B_{22} has been derived rigorously [30, 45], and is reported as:

$$B_{22} = \frac{V_0 - V_r}{N \cdot M_w} \quad (1)$$

where N is the total amount of immobilized protein molecules (g) accessible for mobile protein molecules and M_w is the molecular weight of the protein (g/mol). V_0 (mL) and V_r (mL) are the retention volumes in protein-free column and protein-immobilized column, respectively.

Retention time of the mobile phase protein is higher when attracting interaction takes place between the mobile-phase protein and immobilized protein on the SIC column.

On the other hand, the retention time is shorter when the interaction is repulsive. In

Deleted:

Deleted: where

Deleted: figure

Deleted: The osmotic second virial coefficient (

Deleted:)

Deleted: g

Deleted: ⁻¹

Deleted: ml

Deleted: ml

Deleted: protein

Deleted: protein

Deleted: attractive

Deleted: mobile

Deleted: in

1
2
3
4
5
6
7
8
9
10
11
12
13
14
15
16
17
18
19
20
21
22
23
24
25
26
27
28
29
30
31
32
33
34
35
36
37
38
39
40
41
42
43
44
45
46
47
48
49
50
51
52
53
54
55
56
57
58
59
60

this technique, mobile-phase conditions can be selected to approximate those favorable for crystal growth so that specific binding interactions associated with crystallization can potentially be harnessed in a chromatographic mode. Provided that the immobilized protein retains its native 3-D structure, the resulting retention time will reflect the average protein-protein interaction energy under the solution conditions employed.

Deleted: mobile

2.3.1 Micro-SIC technology

Rapid advances in micro fluidic technology are revolutionizing chemical and biochemical analysis in the pharmaceutical industry [46–51]. The successful application in measuring protein-protein interactions by SIC through B_{22} screening and the growing interest for a micro fluidic platform for rapid biochemical analysis have opened a new frontier in a way to couple chromatography and microfluidics. In this context, protein interactions have been successfully measured by microchip SIC by packing the miniaturized chromatographic column with Toyopearl particles and using lysozyme as a model protein [31]. Extending the microfluidic and self-interaction chromatography platform, we recently developed a novel miniaturized experimental procedure for measuring protein-protein interactions by SIC on a microchip, without the use of chromatographic resins [52], (Fig. 2). ((Figure 2)) This successful miniaturization to a microchip level of measurement device for protein self-interaction data is a first key step to a complete microfluidic screening platform for the rational design of protein crystallizations, using substantially less expensive protein and experimentation time.

Deleted: -

Deleted: the

Deleted: has

Deleted: were

Deleted: self-interaction chromatography

Deleted: on

Deleted: the

Deleted: ement of

Deleted: ,

Deleted: figure

Deleted: a

Deleted: self

3 SIC protocol

3.1 Protein immobilization on solid surfaces

Immobilization of proteins onto solid surfaces is of great importance and several strategies exist for linking proteins to surfaces, which are mainly based on physical, covalent and bio-affinity immobilization mechanisms. Immobilized proteins can be used as a valuable tool for rapid characterization and high-throughput analysis of thousands of proteins by identifying protein-protein [53], protein-small molecule [54] and protein-nucleic acid [55] interactions. The interaction of proteins with the surface is a complex process dependent upon the nature of the individual protein, its orientation, concentration, time, *etc.*, all of which may influence the final state of the absorbed protein.

Formatted: Font: Italic

Protein immobilization involving physical adsorption suffers from inherent drawback of non-specific interactions resulting from random orientation mechanism [56].

Covalent attachment of proteins to solid surfaces is becoming increasingly important in the field of biotechnology. Most methods that involve covalent attachment rely on non-selective chemical attachment by the reaction between various possible

functional groups on the protein surface (*e.g.*, -NH₂, -SH, -COOH, -OH, etc) with

suitably modified functional groups on solid supports (*e.g.*, carboxylic acid, esters,

aldehyde, maleimide, amine, epoxy, *etc.*) [57]. However, this covalent attachment

chemistry is random in nature and often results in heterogeneous immobilization

pattern. Site-specific immobilization, on the other hand, overcomes the limitation of

random immobilization, resulting in optimal and well-ordered attachment on solid

supports [58]. Bio-affinity immobilization, a site-specific variant, offers the

Formatted: Font: Italic

Deleted: *eg.*

Formatted: Font: Italic

Formatted: Font: Italic

1
2
3 additional advantage of homogeneous attachment and also the possibility of
4
5 detaching the proteins from the surface resulting in a plug-play-type immobilization
6
7 approach [57].

Deleted: play

8 9 10 3.1.1 Normal-scale SIC

Deleted: Normal

11
12
13
14
15 To set up an SIC experiment, the first step is to immobilize protein molecules on the
16
17 chromatography media. The immobilized proteins should be tightly bound to the
18
19 solid surface and should not get detached during the experimentation. For the
20
21 purpose of self-interaction, the chromatographic material should not have any other
22
23 mechanism of retaining proteins other than weak protein interactions.

Deleted: a

Deleted: rather

24
25 Chromatography media used till date in the field of SIC are activated agarose [33],
26
27 Toyopearl-tresyl [31, 32], Toyopearl-amino [35] and Toyopearl-formyl [34] groups.

28
29 There is no concrete general immobilization chemistry and a variety of proteins

30
31 (pI 2–10) can be immobilized using a general protocol [59]. The incubation time,
32
33 temperature, pH and protein concentration of the immobilization reaction mixture are
34
35 the parameters for controlling the immobilization reaction. From the coupling point

Deleted: pI

Deleted: -

Formatted: Font: Italic

Formatted: Font: Italic

36
37 of view, both tresyl-Toyopearl and N-hydroxysuccinimide (NHS)-Sephrose are

Formatted: Font: Italic

Deleted:

38
39 good options for SIC. Optimum coupling can be achieved with a surface coverage of

40
41 15% and 12-h incubation time [30]. The immobilized proteins must be randomly

Deleted: of

42
43 oriented on the solid support to prevent protein interaction in only one specific

Deleted: in order

44
45 direction. The pattern of immobilization, either random or specific, can be obtained

46
47 by carrying out limited proteolysis of the immobilized protein and observing the

48
49 obtained peptide distribution pattern. More description on the possible influencing

parameters and the detailed experimental considerations for the design of a protein

SIC can be found in literature [30].

Deleted: self-interaction chromatography

3.1.2 Micro-SIC

Microfluidic (or lab-on-a-chip) technologies are gaining ground in the biological and

medical sciences and offer a suitable platform for high-throughput screening

Deleted: high

technologies [60–63]. Proteins present a particular challenge in microfluidic devices

Deleted: (HTS)

Deleted: -

Formatted: Not Superscript/ Subscript

because of the need to maintain structural integrity when attached to a number of

different surface geometries and chemistries [50]. Several strategies have been used

to address the issue of protein-wall interactions [64, 65]. One of the approaches is to

chemically alter the silica surface by coating with linear polyacrylamide or other

hydrophilic functional polymers. The interaction of proteins with the silica surface

through an ion-exchange mechanism is believed to be responsible for degrading the

efficiency and reproducibility of the immobilization process [64]. Nevertheless, there

have been a number of recent reports where proteins, including enzymes, have been

Deleted: has

incorporated into micro-channels while maintaining biological activity [66]. High-

throughput analysis of protein-protein interactions in a microfluidic platform can be

achieved by carefully selecting the protein immobilization strategy that allows the

Deleted: which

protein to retain its biological activity.

Recently, we described a novel method of protein SIC on microchip by immobilizing

Deleted: self-interaction chromatography

an example protein, lysozyme, covalently to the microchip channel wall and

monitoring protein interactions via a B_{22} screen [52]. The protocol involved

Formatted: Font: Italic

covalently modifying the silica surface using 3-aminopropyltriethoxysilane (APTES),

Deleted:

a short spacer, used for avoiding surface-protein interactions and to overcome steric

Deleted: ,

hindrance from the vicinity of the support. The protein was then covalently coupled to the APTES molecule activated by glutaraldehyde. The schematic description of the setup used for micro fluidic SIC runs is shown in Fig. 3.

Deleted: self-interaction chromatography

Deleted: figure

((Figure 3))

Experiments were carried out to monitor lysozyme retention times as a function of NaCl concentration in the mobile phase under different pH conditions. The labeled protein solution was then passed through the microchip by a continuous buffer flow and the protein pulse was detected at the chip inlet and at the outlet by fluorescence detection. The difference in retention time gives the measure of protein-protein

Deleted: means of

interactions through calculating the parameter B_{22} . Mapping of lysozyme's B_{22} profile, at different pH values, is shown in Fig. 4, and compared to various literature data obtained using different B_{22} measuring techniques under the same or similar conditions.

Deleted: by

Deleted: obtained under the same or similar conditions,

Deleted: is shown in figure 4

((Figure 4))

Quantitative agreement between virial coefficients measured by SIC and traditional characterization methods were obtained for the protein lysozyme over a range of pH and ionic strengths. It can also be seen that the micro-SIC data (Fig. 4, solid lines) were able to reproduce larger scale B_{22} data and were precise in comparison with

Deleted: self-interaction chromatography

Deleted: figure

Deleted: was

Deleted: as

other reported techniques. The overall approach of SIC on a microchip worked successfully and the protein immobilization chemistry on the channel surface could reproduce larger scale SIC data. This approach avoided the use of packing material normally used for chromatography columns, such as resins, beads or particles. Many microfluidic systems are now based on polymeric materials, like polycarbonate (PC), polymethylmethacrylate (PMMA), and polydimethylsiloxane (PDMS) for which surface modifications are required as they do not contain any functional groups in their native form [66]. The micro-SIC method also provides the significant advantage

Deleted: self-interaction chromatography

Deleted: (

Deleted:)

Deleted: (

Deleted:)

Deleted: in

of being at least an order of magnitude less expensive in terms of the amount of protein and time required than normal-scale SIC and other conventional characterization methods.

Deleted: normal

4 B_{22} results and applicability to the crystallization slot

The key to growing high-quality protein crystals is knowing which solution conditions (temperature, pressure, protein concentration, precipitating agent concentration, *etc*) are favorable for crystallization. The usual approach is to extensively screen in a wide range of solution conditions, out of which a number of conditions give a “hit”. Over the years, it has been observed that there is a commonality to the solution conditions that give the experimenter the “hit” and that commonality is expressed as the B_{22} value. It is postulated that protein crystallization

Formatted: Font: Italic

can only occur in a narrow range of slightly negative B_{22} values ($\sim -1 \times 10^{-4}$ to -8×10^{-4} mol mL $^{-1}$ g $^{-2}$) [18, 42]. In positive B_{22} solution conditions, there will be no precipitation while in too-negative B_{22} conditions, amorphous precipitates dominate.

Deleted: only

Deleted: -

Deleted: -

Deleted:

Deleted: x

Deleted: -

Deleted: ml

Deleted: -

Deleted: protein crystallization can occur

Deleted: too

Deleted: self-interaction chromatography

Apart from model protein lysozyme, there has been a wealth of experimental evidence of B_{22} values for different types of proteins using SIC (Fig. 5).

((Figure 5))

The crystallization slot (between red dashed lines, Fig. 5) is an empirical representation of solution conditions for which crystallization of the protein has been successfully reported [11]. The link between B_{22} and protein crystallization conditions offers the possibility that screening B_{22} values may be useful for the predictive crystallization of proteins proven difficult to crystallize. This also gives the experimenter a fair insight into possible modification of solution conditions so as to

Deleted: figure

Deleted: figure

1
2
3
4
5
6
7
8
9
10
11
12
13
14
15
16
17
18
19
20
21
22
23
24
25
26
27
28
29
30
31
32
33
34
35
36
37
38
39
40
41
42
43
44
45
46
47
48
49
50
51
52
53
54
55
56
57
58
59
60

push a particular protein into the crystallization slot. Nevertheless, for identical solution conditions, changes in the solubility trend of different proteins can be related to the observed B_{22} behavior and can be used as a predictive tool for crystallizing industrially relevant proteins.

In the recent years, there has been a growing need to develop polypeptide formulations at relatively high concentrations (>100 mg/mL). Following on the crystallization slot hypothesis for proteins [11], it would be possible to rationally increase the solubility of any given peptide by measuring the peptide virial coefficient and adapting to those solution conditions where B_{22} is positive. Although it is known that peptides self-associate in aqueous solutions, their ability to scatter light is very weak, making the SLS technique inadequate for virial coefficient measurements. Recently, SIC, which does not have the same molecular size limitations as SLS, has been successfully used, for the first time, for the measurement of the virial coefficient of a 36-amino acid therapeutic peptide “Enfuvirtide” as a function of solution conditions (Fig. 5, solid blue line). The B_{22} determined by SIC was found to correlate strongly with solubility and apparent molecular weight of the peptide [38], demonstrating that it was possible to measure B_{22} for a peptide in a relatively rapid fashion and also suggested the practical applicability of the measuring technique, SIC.

5 How to use SIC for stable protein formulation?

The number of protein-based therapeutic products is growing. The main issues in developing these products are in-process stability and solubility. In addition to the stability during the manufacturing process, the protein formulation products should

Deleted: ((Figure 5))

Deleted: ml

Deleted: figure

Formatted: Font: Not Italic, Not Superscript/ Subscript

Deleted: in

1
2 be physically, chemically and biologically stable for a long shelf life [73]. Protein
3 stability consists of (i) conformational stability, and (ii) colloidal stability of the
4 protein in the solution [74, 76]. Thermodynamically, conformational stability of a
5
6 protein's native state can be given in terms of free energy. The free energy of native
7
8 conformation is only 5-6 kcal/mol less than the free energy of non-native
9
10 conformations, which are biologically inactive [77, 78]. The balance between large
11
12 stabilizing forces and large destabilizing forces results in this net conformational
13
14 stability. The free energy of folding arises due to contributions from electrostatics
15
16 (charge repulsion and ion pairing), hydrogen bonding, van der Waals interactions,
17
18 and hydrophobic interactions [77, 78].

19
20 To develop a stable protein formulation, both conformational and colloidal stability
21
22 of the protein in solution should be achieved. The conformational stability is
23
24 measured by (ΔG° unfold) and the colloidal stability is measured by the osmotic
25
26 second virial coefficient (B_{22}) in a solution [75]. B_{22} accounts for both short- and
27
28 long-range interactions, such as electrostatic interactions, van der Waals interactions,
29
30 excluded volume, and hydrophobic interactions [75, 79]. A positive B_{22} indicates that
31
32 the protein-protein interactions are repulsive; consequently, in a solution the protein
33
34 molecules stay apart from each other, and prevent crystallization and aggregation.
35
36 Crystallization and aggregation require the protein molecules to come together to
37
38 from a nucleation center [69] In other words, a positive B_{22} indicates that the protein
39
40 in a solution is colloiddally stable. A negative B_{22} suggest attractive protein-protein
41
42 interactions, a condition favorable for crystallization/aggregation. Thus, the solutions
43
44 for which, B_{22} values are negative are colloiddally unstable [80].

45
46
47
48
49
50
51
52
53
54
55
56
57
58
59
60
SIC was used as an innovative approach to screen for physical stability of a
Pseudomonas amylase, monitoring the pattern of the parameter B_{22} [39]. Increasing
the concentration of stabilizing agents shifted the value of B_{22} to positive region

Deleted: 1

Deleted: 2

Deleted: -

Deleted: -

Deleted: 6

Deleted:

Deleted: ((Figure 6))

Deleted: elf-interaction chromatography

1
2
3
4
5
6
7
8
9
10
11
12
13
14
15
16
17
18
19
20
21
22
23
24
25
26
27
28
29
30
31
32
33
34
35
36
37
38
39
40
41
42
43
44
45
46
47
48
49
50
51
52
53
54
55
56
57
58
59
60

(Fig. 6a). This positive shift in the trend of B_{22} was in strong qualitative agreement with the marked increase in the enzymatic activity (Fig. 6b). This was not only an indicator of co-solvent-induced physical stability of the amylase, but also indicated an important role of SIC, *via* a B_{22} screen, for rational formulation screening of more industrially relevant enzymes.

Deleted: figure

Deleted: figure

Deleted: solvent

Deleted: indicating

Formatted: Font: Italic

((Figure 6))

Recently, intermolecular interactions of lysozyme in native and denatured state, in the presence of different co-solvents, were also characterized in terms of B_{22} determined by SIC [81]. The results indicated that SIC can be used as a rapid screening process for estimating B_{22} values of different protein stabilizers/aggregation inhibitors, which in turn can be used in stabilizing the refolded protein product by enhancing the protein folding rate. In another study, protein self-interactions (B_{22}) for untested formulation conditions were measured by a high-throughput SIC approach by combining an incomplete factorial screen technique with an artificial neural network model [82]. It can be seen that B_{22} can not only predict solubility behavior, but can also predict the protein colloidal stability. Miniaturized SIC on a high-throughput automated platform can further accelerate the determination of optimum conditions to improve the physical stability of drug formulations. In future, this correlation can be used by pharmaceutical companies to fine-tune the colloidal stability to obtain stable formulations of therapeutic proteins solutions with long shelf lives.

Deleted:

Deleted:

Deleted: in order

Deleted: lifes

6 Concluding remarks

Recent advances in the development of SIC technologies, especially the micro-SIC technology platform, provide the opportunity of rapid screening of B_{22} values of a protein under various solution conditions. Due to the availability of an SIC-based competent B_{22} screening technology, the application of B_{22} is being extended beyond protein crystallization prediction; *i.e.*, protein stability and prediction of stable formulation conditions.

Deleted: SIC

Deleted: recently

Deleted: namely

Formatted: Font: Italic

The authors acknowledge financial support for this project from the Delft Research Centers, SIP (Sustainable Industrial Processes) and LST (Life Science and Technology).

((Funded by:

- Sustainable Industrial Processes, Delft Research Center
- Life Science and Technology, Delft Research Center).

Formatted: Font: Not Italic

Formatted: Bullets and Numbering

Formatted: Font: Not Italic

Formatted: Font: Not Italic

Formatted: Font: Not Italic

The authors have declared no conflict of interest.

Formatted: Line spacing: Double

7 References

- [1] Ritthausen, H., Krystallinische. Eiweisskorper aus verschiedenen Oel-samen. J. Prakt. Chem 1881, 23, 481–486.
- [2] Osborne, T. B., Crystallized vegetable proteids. Am. Chem. J., 1892, 14, 662.
- [3] Ries-Kautt, M. M., Ducruix, A. F., Relative effectiveness of various ions on the solubility and crystal growth of lysozyme. J. Biol. Chem., 1989, 264, 745–748.

Formatted: English (U.S.)

Deleted: Prakt, J., Chem 23, 1881, 481

Formatted: Font: (Default) Times New Roman, 12 pt

Formatted: English (U.S.)

Deleted: ,

Deleted:

Deleted: ,

Deleted: -

- [4] Rosenbaum, D. F., Kulkarni, A., Ramakrishnan, S., Zukoski, C. F., Protein interactions and phase behavior: Sensitivity to the form of the pair potential, *J. Chem. Phys.* 1999, *111*, 9882–9890.
- [5] Cleland, J. L., Powell, M. F., Shire, S. J., The development of stable protein formulations: A close look at protein aggregation, deamidation, and oxidation, *Crit. Rev. Ther. Drug Carrier Sys.* 1993, *10*, 307–377.
- [6] Berne, B. J., Pecora, R., *Dynamic Light Scattering*, John Wiley, New York 1976.
- [7] Chu, B. *The Application of Light Scattering to the Study of Biological Motion*, Earnshaw, J., Steer, M. (Eds.), Plenum Press, New York 1983, p. 53.
- [8] Mikol, V., Hirsch, E., Giegé, R., Monitoring protein crystallization by dynamic light scattering, *FEBS Lett.* 1989, *258*, 63–66.
- [9] Vincent, M., Giegé, R., Phase diagram of a crystalline protein: Determination of the solubility of concanavalin A by a microquantitation assay, *J. Cryst. Growth* 1989, *97*, 324–332.
- [10] Kadima, W., McPherson, A., Dunn, M. F., Journak, F. A., Characterization of precrystallization aggregation of canavalin by dynamic light scattering, *Biophys. J.* 1990, *57*, 125–132.
- [11] George, A., Wilson, W. W., Predicting protein crystallization from a dilute-solution property, *Acta Crystallogr. Sec. D Biol. Crystallogr.* 1994, *50*, 361–365.
- [12] Neal, B. L., Asthagiri, D., Velez, O. D., Lenhoff, A. M. *et al.*, Why is the osmotic second virial coefficient related to protein crystallization? *J. Cryst. Growth* 1999, *196*, 377–387.
- [13] George, A., Chiang, Y., Guo, B., Arabshahi, A. *et al.*, Second virial coefficient as predictor in protein crystal growth, *Method Enzymol.* 1997, *276*, 100–110.

Deleted: ,

Deleted: ,

Deleted:

Deleted: ,

Deleted: *apeut*

Deleted: ,

Deleted: -

Formatted: Font: Italic

Deleted: New York,

Formatted: Font: Not Italic

Formatted: Font: Italic

Deleted: edited by

Deleted: &

Deleted: New York:

Formatted: Font: Not Italic

Formatted: Font: Not Italic

Formatted: Font: Not Italic

Deleted: ,

Deleted: ,

Deleted: -

Deleted: ,

Deleted: *Crystal*

Deleted: ,

Deleted: -

Deleted: ,

Deleted: ,

Deleted: -

Deleted: ,

Deleted: ,

Deleted: ,

Deleted: ,

Deleted: ,

Deleted: ,

[14] Rosenbaum, D., Zamora, P. C., Zukoski, C. F., Phase behavior of small attractive colloidal particles, *Phys. Rev. Lett.* 1996, 76, 150–153.

Deleted: ,

Deleted: ..

[15] Haas, C., Drenth, J., Wilson, W. W., Relation between the solubility of proteins in aqueous solutions and the second virial coefficient of the solution, *J. Phys. Chem. B* 1999, 103, 2808–2811.

Deleted: ,

Deleted: ,

[16] Rosenbaum, D. F., Kulkarni, A., Ramakrishnan, S., Zukoski, C. F., Protein interactions and phase behavior: Sensitivity to the form of the pair potential, *J. Chem. Phys.* 1999, 111, 9882–9890.

Deleted: ,

Deleted: ,

[17] Ruppert, S., Sandler, S. I., Lenhoff, A. M., Correlation between the osmotic second virial coefficient and the solubility of proteins, *Biotechnol. Prog.* 2001, 17, 182–187.

Deleted: ,

Deleted: ,

[18] Velev, O. D., Kaler, E. W., Lenhoff, A. M., Protein interactions in solution characterized by light and neutron scattering: Comparison of lysozyme and chymotrypsinogen, *Biophys. J.* 1998, 75, 2682–2697.

Deleted: ,

Deleted: ,

Deleted: ,

[19] Guo, B., Kao, S., McDonald, H., Asanov, A., *et al.*, Correlation of second virial coefficients and solubilities useful in protein crystal growth, *J. Cryst. Growth* 1999, 196, 424–433.

Deleted: ,

Deleted: ,

[20] Ruppert, S., Sandler, S. I., Lenhoff, A. M., Correlation between the osmotic second virial coefficient and the solubility of proteins, *Biotechnol. Prog.* 2001, 17, 182–187.

Deleted: ,

Deleted: ,

[21] Chi, E. Y., Krishnan, S., Kendrick, B. S., Chang, B. S., *et al.*, Roles of conformational stability and colloidal stability in the aggregation of recombinant human granulocyte colony-stimulating factor, *Protein Sci.* 2003, 12, 903–913.

Deleted: ,

Deleted: ,

Deleted: ,

[22] Ho, J. G. S., Middelberg, A. P. J., Estimating the potential refolding yield of recombinant proteins expressed as inclusion bodies, *Biotechnol. Bioeng.* 2004, 87, 584–592.

Deleted: ,

Deleted: ,

[23] Ho, J. G. S., Middelberg, A. P. J., Ramage, P., Kocher, H. P., The likelihood of aggregation during protein renaturation can be assessed using the second virial

coefficient, *Protein Sci.* 2003, 12, 708–716.

Deleted: ,

Deleted: ,

Deleted: ,

[24] Ahamed, T., Esteban, B. N. A., Ottens, M., van Dedem, G. W. K. *et al.*,

Phase behavior of an intact monoclonal antibody. *Biophys. J.* 2007, 93, 610–619.

Deleted: Biophysical

Deleted: ournal,

Deleted: (2)

[25] Behlke, J., Ristau, O., Analysis of the thermodynamic nonideality of proteins

by sedimentation equilibrium experiments, *Biophys. Chem.* 1999, 76, 13–23.

Deleted: -

Deleted: ,

Deleted: ,

[26] Bonnet, F., Finet, S., Tardieu, A., Second virial coefficients: variations with

lysozyme crystallization conditions, *J. Cryst. Growth* 1999, 196, 403–413.

Deleted: ,

Deleted: Crystal

Deleted: ,

[27] Moon, Y. U., Curtis, R. A., Anderson, C. O., Blanch, H. W. *et. al.*, Protein–

protein interactions in aqueous ammonium sulfate solutions: Lysozyme and bovine

serum albumin (BSA). *J. Solut. Chem.* 2000, 29, 699–717.

Deleted: -

Deleted: ,

Deleted:),

Deleted: ,

Deleted: a

[28] Patro, S. Y., Przybycien, T. M., Self-interaction chromatography: A tool for

the study of protein–protein interactions in bioprocessing environments, *Biotechnol.*

Bioeng. 1996, 52, 193–203.

Deleted: ,

Deleted: ,

Deleted: ,

[29] Tessier, P. M., Vandrey, S. D., Berger, B. W., Pazhianur, R. *et. al.*, Self-

interaction chromatography: A novel screening method for rational protein

crystallization, *Acta Crystallogr. Sec. D Biol. Crystallogr.* 2002, 58, 1531–1535.

Deleted: ,

Deleted: a

Deleted: ,

Deleted: ,

Deleted: ,

[30] Ahamed, T., Ottens, M., van Dedem, G. W. K., van der Wielen, L. A. M.,

Design of self-interaction chromatography as an analytical tool for predicting protein

phase behavior, *J. Chromatogr. A* 2005, 1089, 111–124.

Deleted: ,

Deleted: ,

[31] Garcia, C. D., Hadley, D. J., Wilson, W. W., Henry, C. S., Measuring protein

interactions by microchip self-interaction chromatography, *Biotechnol. Prog.* 2003,

19, 1006–1010.

Deleted: ,

Deleted: ,

[32] Garcia, C. D., Holman, S. C., Henry, C. S., Wilson, W. W., Screening of protein-ligand interactions by affinity chromatography, *Biotechnol. Prog.* 2003, 19, 575–579.

Deleted: ,

Deleted: ,

[33] Teske, C. A., Blanch, H. W., Prausnitz, J. N., Measurement of lysozyme–lysozyme interactions with quantitative affinity chromatography, *J. Phys. Chem. B* 2004, 108, 7437–7444.

Deleted: ,

Deleted: ,

[34] Tessier, P. M., Lenhoff, A. M., Sandler, S. I., Rapid measurement of protein osmotic second virial coefficients by self-interaction chromatography, *Biophys. J.* 2002, 82, 1620–1631.

Deleted: ,

Deleted: ,

[35] Tessier, P. M., Johnson, H. R., Pazhianur, R., Berger, B. W., *et. al.*, Predictive crystallization of ribonuclease A *via* rapid screening of osmotic second virial coefficients, *Proteins Struct. Funct. Genet.* 2003, 50, 303–311.

Deleted: ,

Formatted: Font: Italic

Deleted: ,

[36] Teske, C. A., Blanch, H. W., Prausnitz, J. M., Chromatographic measurement of interactions between unlike proteins, *Fluid Phase Equilib.* 2004, 219, 139–148.

Deleted: ,

Deleted: ,

[37] Tessier, P. M., Sandler, S. I., Lenhoff, A. M., Direct measurement of protein osmotic second virial cross coefficients by cross-interaction chromatography, *Protein Sci.* 2004, 13, 1379–1390.

Deleted: ,

Deleted: ,

Deleted: ,

[38] Payne, R. W., Nayar, R., Tarantino, R., Terzo, S. D., *et. al.*, Second virial coefficient determination of a therapeutic peptide by self-interaction chromatography, *Peptide Sci.* 2006, 84, 527–533.

Deleted: ,

Deleted: ence,

Deleted: -

Deleted: ,

[39] Valente, J. J., Fryksdale, B. G., Dale, D. A., Gaertner, A. L., *et. al.*, Screening for physical stability of a *Pseudomonas* amylase using self-interaction chromatography, *Anal. Biochem.* 2006, 357, 35–42.

Formatted: Font: Italic

Deleted: ,

Deleted: ytical

Deleted: istry

Deleted: ,

Deleted: ,

Deleted: -

[40] Kornmann, H., Collet, N., Baer, G., Self-interaction chromatography applied to the rapid development of formulation for therapeutic proteins, 234th ACS National Meeting, BIOT session 228, 2007, Boston, USA.

- [41] Chiancone, E., Fronticelli, C., Gattoni, M., Urbaitis, B. K. *et. al.*, Immobilized hemoglobin in the purification of hemoglobin-based oxygen carriers, *J. Chromatogr.* 1992, 604, 117–123.
- [42] Przybycien, T. M., Protein–protein interactions as a means of purification, *Curr. Opin. Biotechnol.* 1998, 9, 164–170.
- [43] Tessier, P. M., Lenhoff, A. M., Measurements of protein self-association as a guide to crystallization, *Curr. Opin. Biotechnol.* 2003, 14, 512–516.
- [44] Valente, J. J., Verma, K. S., Manning, M. C., Wilson, W. W. *et. al.*, Second virial coefficient studies of cosolvent-induced protein self-interaction, *Biophys. J.* 2005, 89, 4211–4218.
- [45] Winzor, D. J., Scott, D. J., Wills, P. R., A simpler analysis for the measurement of second virial coefficients by self-interaction chromatography, *Anal. Biochem.* 2007, 371, 21–25.
- [46] Hadd, A. G., Raymond, D. E., Halliwell, J. W., Jacobson, S. C. *et. al.*, Microchip device for performing enzyme assays, *Anal. Chem.* 1997, 69, 3407–3412.
- [47] Jones, F., Forrest, S., Palmer, J., Lu, Z. *et. al.*, Immobilized enzyme studies in a micro-scale bioreactor, *Appl. Biochem. Biotechnol.* 2004, 113–116, 261–272.
- [48] Krenkova, J., Foret, F., Immobilized microfluidic enzymatic reactors, *Electrophoresis* 2004, 25, 3550–3563.
- [49] Ku, B., Cha, J., Srinivasan, A., Kwon, S. J. *et. al.*, Chip-based polyketide biosynthesis and functionalization, *Biotechnol. Prog.* 2006, 22, 1102–1107.
- [50] Lee, M-Y., Srinivasan, A., Ku, B., Dordick, J. S., Multienzyme catalysis in microfluidic biochips, *Biotechnol. Bioeng.* 2003, 83, 20–28.
- [51] Srinivasan, A., Wu, X., Lee, M-Y., Dordick, J. S., Microfluidic peroxidase biochip for polyphenol synthesis, *Biotechnol. Bioeng.* 2003, 81, 563–569.

Deleted: ,

Deleted: ,

Deleted: ,

Deleted: ,

Deleted: ,

Deleted: ,

Deleted: ,

Deleted: ,

Deleted: ,

Deleted: ,

Deleted: ,

Deleted: istry,

Deleted: -

Deleted: ,

Deleted: ,

Deleted: -

Deleted: -

Deleted: ,

Deleted: ,

Deleted: -

Deleted: -

Deleted: ,

Deleted: ,

Deleted: -

Deleted: -

Deleted: ,

Deleted: ,

Deleted: -

Deleted: Srinivisan

Deleted: ,

Deleted: ,

Deleted: -

Deleted: ,

Deleted: ,

Deleted: -

[60] Els-Ali, J., Sorger, P. K., Jensen, K. F., Cells on chips, *Nature*, 2006, 442, 403–411.

Deleted: ,

Deleted: ,

[61] Powers, M. J., Domansky, K., Kaazempur-Mofrad, M. R., Kalezi, A., *et. al.*, A micro fabricated array bioreactor for perfused 3D liver culture, *Biotechnol. Bioeng.* 2002, 78, 257–269.

Deleted: ,

Deleted: ,

Deleted: ,

[62] Yager, P., Edwards, T., Fu, E., Helton, K., *et. al.*, Microfluidic diagnostic technologies for global public health, *Nature*, 2006, 442, 412–418.

Deleted: ,

Deleted: ,

Deleted: ,

[63] Qin, J. H., Ye, N. N., Liu, X., Lin, B. C., Microfluidic devices for the analysis of apoptosis, *Electrophoresis*, 2005, 26, 3780–3788.

Deleted: ,

Deleted: ,

[64] Lauer, H. H., McManigill, D., Capillary zone electrophoresis of proteins in untreated fused silica tubing, *Anal. Chem.*, 1986, 58, 166.

Deleted: ,

Deleted: ,

[65] Walbroehl, Y., Jorgenson, J. W., Capillary zone electrophoresis for the determination of electrophoretic mobilities and diffusion coefficients of proteins, *J. Microcolumn Sep.*, 1989, 1, 41.

Deleted: ,

Deleted: ,

Deleted: ,

[66] Soper, S. A., Henry, A. C., Vaidya, B., Galloway, M., *et. al.*, Surface modification of polymerbased microfluidic devices, *Anal. Chim. Acta*, 2002, 470, 87–99.

Deleted: ,

Deleted: ,

Deleted: ,

Deleted: ,

[67] Ahamed, T., Predictive crystallization of proteins using self-interaction chromatography, *PD Engineering Thesis*, 2004, TU Delft.

Deleted: ,

[68] Bonnete, F., Finet, S., Tardieu, A., Second virial coefficient: variations with lysozyme crystallization conditions, *J. Cryst. Growth*, 1999, 196, 403–414.

Deleted: ,

Deleted: Crystal

Deleted: ,

[69] Curtis, R. A., Prausnitz, J. M., Blanch, H. W., Protein-protein and protein-salt interactions in aqueous protein solutions containing concentrated electrolytes, *Biotechnol. Bioeng.* 1998, 57, 11–21.

Deleted: -

Deleted: ,

Deleted: ogy and

Deleted: ineering,

[70] Curtis, R. A., Ulrich, J., Montaser, A., Prausnitz, J. M., *et. al.*, Protein-protein interactions in concentrated electrolyte solutions, *Biotechnol. Bioeng.* 2002, 79, 367–380.

Deleted: ,
Deleted: ,
Deleted: ogy and
Deleted: ineering,

[71] Asanov, A. N, DeLucas, L. J, Oldham, P. B, Wilson, W. W, Interfacial aggregation of bovine serum albumin related to crystallization conditions studied by total internal reflection fluorescence, *J Colloid Interface Sci.* 1997, 196, 62–73.

Deleted: ,
Deleted: ,
Deleted: -

[72] Costenaro, L., Zaccai, G., Ebel, C., Link between protein–solvent and weak protein–protein interactions gives insight into halophilic adaptation, *Biochemistry* 2002, 41, 13245–13252.

Deleted: ,
Deleted: ,
Deleted: -

[73] Shahrokh, Z., Sluzky, V., Cleland, J. L., Shire, S. J., *et. al.*, Therapeutic protein and peptide formulation and delivery, *ACS symposium series*, 1997, 675.

Deleted: ,

[74] Krishnan, S., Chi, E. Y., Webb, J. N., Chang, B. S., *et al.*, Aggregation of granulocyte colony stimulating factor under physiological conditions: Characterization and thermodynamic inhibition, *Biochemistry* 2002, 41, 6422–6431.

Deleted: ,

[75] Chi, E. Y., Krishnan, S., Kendrick, B. S., Chang, B. S., *et. al.*, Roles of conformational stability and colloidal stability in the aggregation of recombinant human granulocyte colony-stimulating factor, *Protein Sci.* 2003, 12, 903–913.

Deleted: ,
Deleted: ,
Deleted: ,

[76] Kim, Y.-S., Jones, L. S., Dong, A., Kendrick, B. S., *et. al.*, Effects of sucrose on conformational equilibria and fluctuations within the native-state ensemble of proteins, *Protein Sci.* 2003, 12, 1252–1261.

Deleted: ,
Formatted: German (Germany)
Deleted: ence,
Deleted: ,

[77] Chi, E. Y., Krishnan, S., Randolph, T. W., Carpenter, J. F., Physical stability of proteins in aqueous solution: Mechanism and driving forces in nonnative protein aggregation, *Pharm. Rev.* 2003, 20, 1325–1336.

Deleted: ,
Deleted: ence,

[78] Dill, K. A., Dominant forces in protein folding, *Biochemistry* 1990, 29, 7133–7155.

Deleted: ,
Deleted: Pharmaceutical
Deleted: iew,
Deleted: ,
Deleted: ,

[79] Valente, J. J., Verma, K. S., Manning, M. C., Wilson, W. W. *et. al.*, Second virial coefficient studies of cosolvent-induced protein self-interaction, *Biophys. J.* 2005, 89, 4211–4218.

Deleted: ..., ...Biophysical ... [1]

[80] Curtis, R. A., Steinbrecher, C., Heinemann, M., Blanch, H. W. *et. al.*, Hydrophobic forces between protein molecules in aqueous solutions of concentrated electrolyte, *Biophys. Chem.* 2002, 98, 249–265.

Deleted: ..., ...Biophysical ... [2]

[81] Dong, X. Y., Liu, J. H., Liu, F. F., Sun, Y., Self-interaction of native and denatured lysozyme in the presence of osmolytes, L-arginine and guanidine hydrochloride, *Biochem. Eng. J.* 2009, 43, 321–326.

Deleted: L

Formatted: Small caps

Deleted: , ...Biochemical Engineering ...ournal... [3]

Formatted: Font: Italic

Deleted: -

[82] Johnson, D. H., Parupudi, A., Wilson, W. W., DeLucas, L. J., High-throughput self-interaction chromatography: Applications in protein formulation prediction, *Pharm. Res.* 2009, 26, 296–305.

Deleted: , ...Pharmaceutical each... [4]

Formatted [5]

Deleted: (2)

Deleted: Figure ...normal ...self interaction chromatography [6]

Figure 1. Schematic representation of a normal-scale SIC concept.

Deleted: Figure ...micro ...self interaction chromatography [7]

Figure 2. Schematic representation of micro-scale SIC concept.

Deleted: Figure ...self-interaction chromatography [8]

Figure 3. Schematic description of setup used for micro fluidic SIC runs.

Deleted: Figure

Figure 4. (a) Osmotic second virial coefficients (B_{22}) trend of lysozyme at pH 7.0–

Deleted: pH ...- [9]

Formatted [10]

7.6. Open triangle with solid line: pH 7.0, 10 mM sodium phosphate buffer, micro-SIC [52]; open square: pH 7.5, 25°C, SLS [18]; black diamond with dash-dot line:

Deleted: pH

Deleted: pH ...⁰ [11]

pH 7.4, 25°C, SLS [31]; black square with long dash line: pH 7.6, 10 mM sodium

Deleted: pH ...⁰ [12]

Deleted: pH ...pH [13]

phosphate buffer, SIC [30]; open diamond with dash-dot-dot line: pH 7.0, 5 mM Bis-

Deleted: pH

Tris buffer, SIC [29]; black triangle with dotted line: pH 7.6, 20 mM sodium

Deleted: pH

phosphate buffer, SIC [33]; open circle with dash line: pH 7.0, 10 mM sodium

Deleted: pH ...- [14]

phosphate buffer, SIC [67]. (b) B_{22} trend of lysozyme at pH 4.2–4.5. Open triangle

Deleted: pH ...pH [15]

with solid line: pH 4.5, 10 mM sodium acetate buffer, micro-SIC [52]; black circle

with long dash line: pH 4.5, 50 mM sodium acetate buffer, small-angle x-ray

1
2 scattering (SAXS) [68]; open circle with dash-dot line: pH 4.5, low-angle laser light

Deleted: pH

3
4 scattering (LLS) [69]; black triangle with dash-dot-dot line: pH 4.5, 25°C, low-angle

Deleted: Low

5
6 LLS [70]; open triangle with dotted line: pH 4.5, 25°C, low-angle LLS [18]; black

Deleted: pH

7
8 diamond with dash-dot line: pH 4.6, SLS [4]; open diamond with dash-dot-dot line:

Deleted: °

9
10 pH 4.5, 10 mM sodium acetate buffer, SIC [30]; black hexagon with dotted line:

Deleted: Low

11
12 pH 4.5, 5 mM sodium acetate buffer [29]; open hexagon with dash-dot line: pH 4.5,

Deleted: pH

13
14 20 mM sodium acetate buffer, SIC [33].

Deleted: °

Deleted: Low

Deleted: pH

Deleted: pH

Deleted: pH

Deleted: pH

15
16 **Figure 5.** B_{22} as a function of precipitating salt concentration. Dashed red lines

Deleted: Figure

17
18 denote the upper and lower boundaries of the crystallization slot. Myoglobin at

Deleted: :

19
20 pH 7.4 (white circle with solid line) [29]; myoglobin at pH 7.0 (black circle with

Deleted: Osmotic second virial coefficients (

21
22 dotted line) [29]; myoglobin at pH 6.0 (black circle with short dash line) [29]; BSA

Deleted:)

23
24 at pH 7.0 (white square with solid line) [71]; BSA at pH 6.2 (black square with

Deleted: pH

25
26 dotted line) [71]; chymotrypsinogen at pH 6.8 (white triangle with short dash line)

Deleted: pH

27
28 [34]; malate dehydrogenase at pH 8.0 (white diamond with solid line) [72];

Deleted: pH

29
30 ovalbumin at pH 6.0 (white inverted triangle with dotted line) [70]; peptide

Deleted: pH

31
32 “Enfuvirtide” at pH 9.0 (solid blue line, no symbols) [38].

Deleted: pH

Deleted: pH

Deleted: pH

Deleted: pH

Deleted: pH

Deleted: pH

Deleted: pH

33
34 **Figure 6.** (a) Effect of stabilizing agents on amylase B_{22} values estimated by SIC. (b)

Deleted: pH

Deleted: Figure

35
36 Activity of amylase as a function of stabilizing agents. Sucrose (black circles) and

Formatted: Font: Not Bold

37
38 sorbitol (white circles); 1% NaCl at pH 6.00 (dotted line); 5% NaCl at pH 4.43 (short

Deleted: Amylase

39
40 dash line); and 1% NaCl at pH 4.53 (solid line) [39].

Deleted: osmotic second virial coefficient (

Deleted:)

Formatted: Font: Not Bold

Deleted: Amylase

Deleted: (w/v)

Deleted: pH

Deleted: (w/v)

Deleted: pH

Deleted: (w/v)

Deleted: pH

Table 1. Comparison of important operating parameters in estimation of B_{22} by different techniques (adapted from [30]).

B_{22} measuring technique	Inherent inaccuracy (mol·mL ⁻²)	Minimum amount of protein required for single B_{22} measurement (mg)	Minimum injection concentration (mg/mL)	Typical time required for single B_{22} measurement (min)
Micro-osmometry (MO)	$\pm 1.0 \times 10^{-4}$	0.60	2.0–10.0	15
Static light scattering (SLS)	$\pm 2.0 \times 10^{-4}$	6.0	30.0	15–25
Size exclusion chromatography (SEC)	$\pm 3.0 \times 10^{-4}$	25.0	15.0–65.0	15
Self interaction chromatography (SIC)	$\pm 1.0 \times 10^{-4}$	0.45	20.0	25
Miniaturized SIC (micro-SIC)	$\pm 1.0 \times 10^{-4}$	0.002	0.15–1.0	5

Deleted: Table

Deleted: .

Formatted: Font: Not Bold

Formatted: Font: Not Bold, Not Superscript/ Subscript

Formatted: Font: Not Bold

Formatted: Font: Not Bold, French (France)

Formatted: Font: Not Bold

Deleted: ml

Deleted: .

Formatted: Font: Not Bold

Formatted: Font: Not Bold

Deleted: .

Deleted: ml

Formatted: Font: Not Bold, French (France)

Formatted: French (France)

Deleted: -¹

Formatted: Font: Not Bold, French (France)

Deleted: x

Deleted: .

Deleted: -

Deleted: x

Deleted: .

Deleted: -

Deleted: x

Deleted: .

Deleted: -

Deleted: x

Deleted: .

Deleted: x

Deleted: .

Deleted: -

1			
2			
3	Page 28: [1] Deleted	MPI	5/31/2009 5:05:00 PM
4			
5	,		
6			
7			
8	Page 28: [1] Deleted	MPI	5/31/2009 5:06:00 PM
9			
10	,		
11			
12	Page 28: [1] Deleted	MPI	5/31/2009 5:06:00 PM
13	<i>Biophysical</i>		
14			
15			
16	Page 28: [1] Deleted	MPI	5/31/2009 5:06:00 PM
17	<i>ournal,</i>		
18			
19			
20	Page 28: [2] Deleted	MPI	5/31/2009 5:06:00 PM
21			
22	,		
23			
24	Page 28: [2] Deleted	MPI	5/31/2009 5:06:00 PM
25			
26	,		
27			
28			
29	Page 28: [2] Deleted	MPI	5/31/2009 5:06:00 PM
30	<i>Biophysical</i>		
31			
32			
33	Page 28: [2] Deleted	MPI	5/31/2009 5:06:00 PM
34	<i>istry,</i>		
35			
36			
37	Page 28: [3] Deleted	MPI	5/31/2009 5:06:00 PM
38			
39	,		
40			
41	Page 28: [3] Deleted	MPI	5/31/2009 5:06:00 PM
42	<i>Biochemical</i>		
43			
44			
45	Page 28: [3] Deleted	MPI	5/31/2009 5:06:00 PM
46	<i>Engineering</i>		
47			
48			
49			
50	Page 28: [3] Deleted	MPI	5/31/2009 5:06:00 PM
51	<i>ournal</i>		
52			
53			
54	Page 28: [3] Deleted	MPI	5/31/2009 4:40:00 PM
55			
56	,		
57			
58	Page 28: [4] Deleted	MPI	5/31/2009 5:07:00 PM
59			
60			

1
2
3
4
5
6
7 **Page 28: [4] Deleted** **MPI** **5/31/2009 5:07:00 PM**

8 *Pharmaceutical*

9
10
11 **Page 28: [4] Deleted** **MPI** **5/31/2009 5:07:00 PM**

12 *earch*

13
14
15 **Page 28: [4] Deleted** **MPI** **5/31/2009 4:40:00 PM**

16
17
18
19 **Page 28: [5] Formatted** **MPI** **5/31/2009 5:07:00 PM**

20 Font: Italic

21 **Page 28: [5] Formatted** **MPI** **5/31/2009 5:08:00 PM**

22 Font: Times New Roman, 12 pt

23 **Page 28: [5] Formatted** **MPI** **5/31/2009 5:08:00 PM**

24 Font: Times New Roman, 12 pt

25 **Page 28: [6] Deleted** **MPI** **5/30/2009 9:16:00 AM**

26 **Figure**

27
28
29
30
31 **Page 28: [6] Deleted** **MPI** **5/31/2009 5:11:00 PM**

32 normal

33
34
35 **Page 28: [6] Deleted** **MPI** **5/31/2009 5:11:00 PM**

36 self interaction chromatography

37
38
39 **Page 28: [7] Deleted** **MPI** **5/30/2009 9:16:00 AM**

40 **Figure**

41
42
43 **Page 28: [7] Deleted** **MPI** **5/31/2009 5:12:00 PM**

44 micro

45
46
47 **Page 28: [7] Deleted** **MPI** **5/31/2009 5:13:00 PM**

48 self interaction chromatography

49
50
51 **Page 28: [8] Deleted** **MPI** **5/30/2009 9:17:00 AM**

52 **Figure**

53
54
55 **Page 28: [8] Deleted** **MPI** **5/31/2009 5:13:00 PM**

56 self-interaction chromatography

1
2
3
4 **Page 28: [9] Deleted** **MPI** **5/31/2009 5:13:00 PM**

5 pH

6
7
8 **Page 28: [9] Deleted** **MPI** **5/31/2009 5:13:00 PM**

9 -

10
11
12 **Page 28: [10] Formatted** **MPI** **5/30/2009 9:17:00 AM**

13 Font: Not Bold

14
15 **Page 28: [11] Deleted** **MPI** **5/31/2009 5:13:00 PM**

16 pH

17
18
19 **Page 28: [11] Deleted** **MPI** **5/31/2009 5:13:00 PM**

20 0

21
22
23 **Page 28: [12] Deleted** **MPI** **5/31/2009 5:13:00 PM**

24 pH

25
26
27 **Page 28: [12] Deleted** **MPI** **5/31/2009 5:13:00 PM**

28 0

29
30
31 **Page 28: [13] Deleted** **MPI** **5/31/2009 5:13:00 PM**

32 pH

33
34
35 **Page 28: [13] Deleted** **MPI** **5/31/2009 5:14:00 PM**

36 pH

37
38
39 **Page 28: [14] Deleted** **MPI** **5/31/2009 5:14:00 PM**

40 pH

41
42
43 **Page 28: [14] Deleted** **MPI** **5/31/2009 5:14:00 PM**

44 -

45
46
47 **Page 28: [15] Deleted** **MPI** **5/31/2009 5:14:00 PM**

48 pH

49
50
51 **Page 28: [15] Deleted** **MPI** **5/31/2009 5:14:00 PM**

52 pH

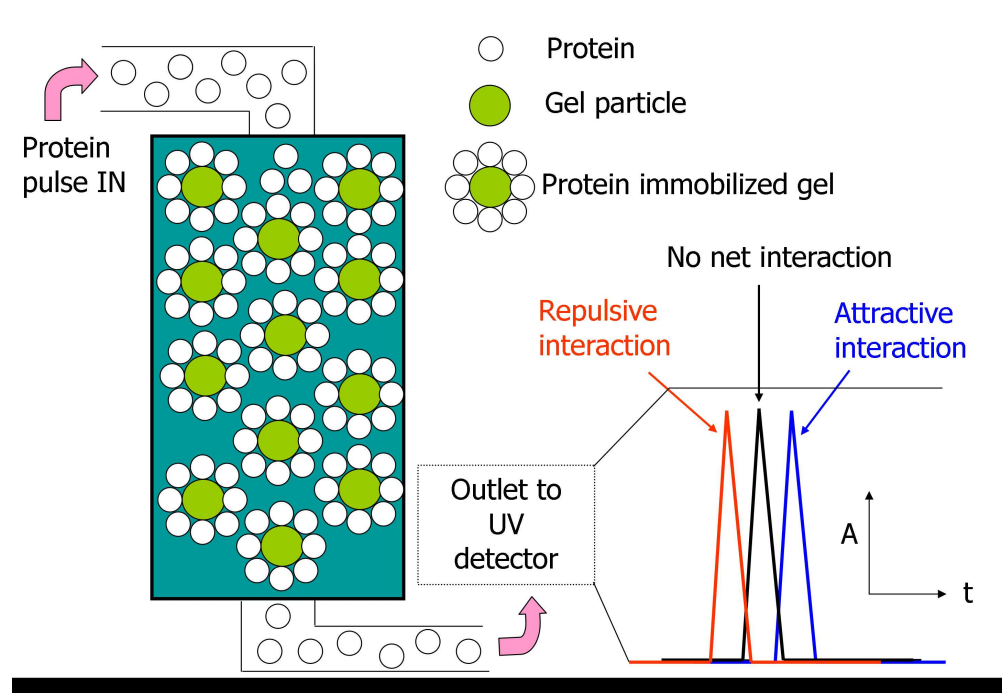

Figure 1. Schematic representation of a normal scale self interaction chromatography concept
246x169mm (300 x 300 DPI)

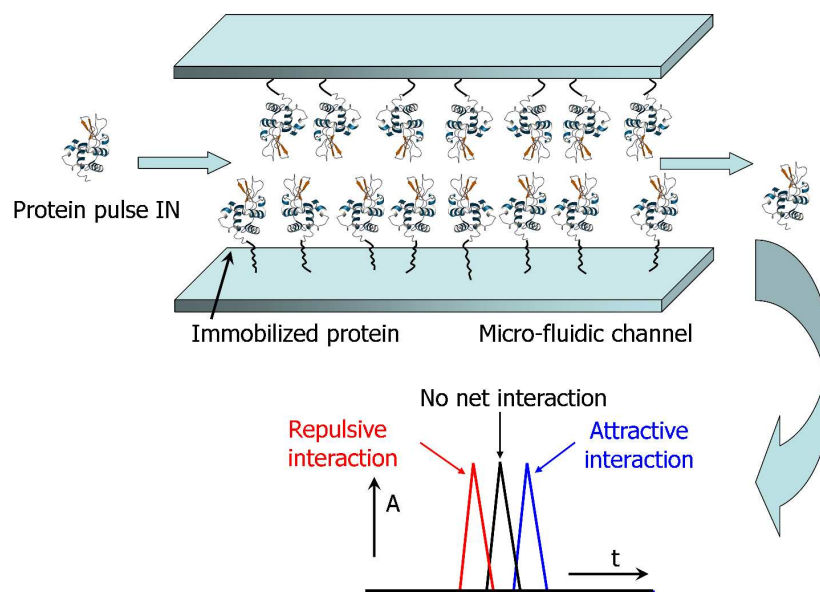

Figure 2. Schematic representation of micro scale self interaction chromatography concept
297x209mm (300 x 300 DPI)

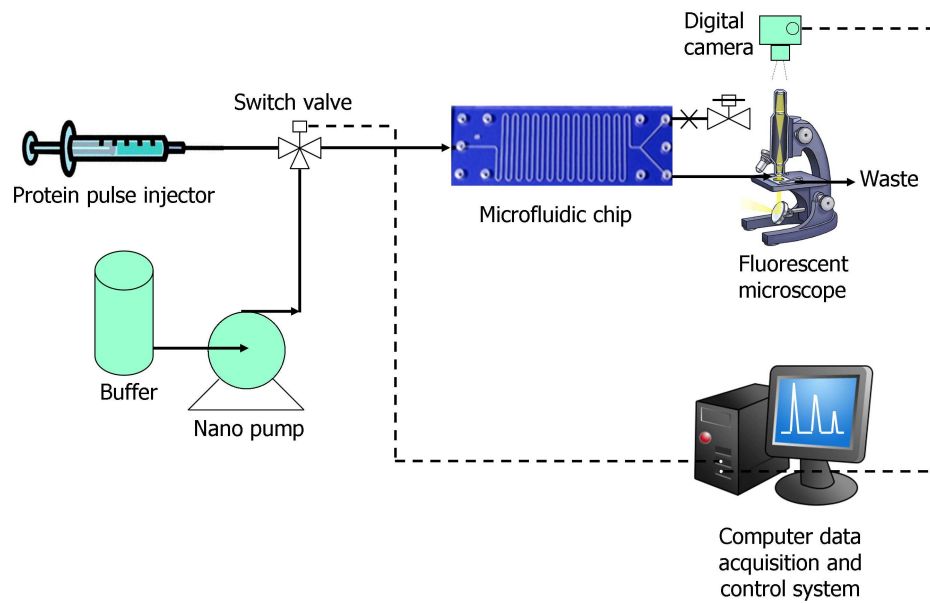
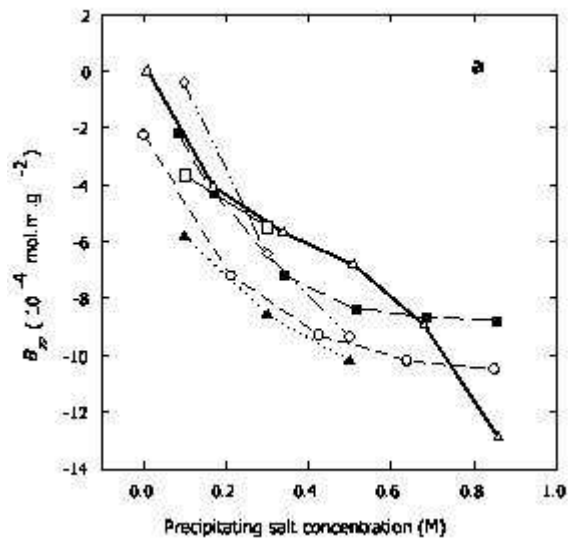
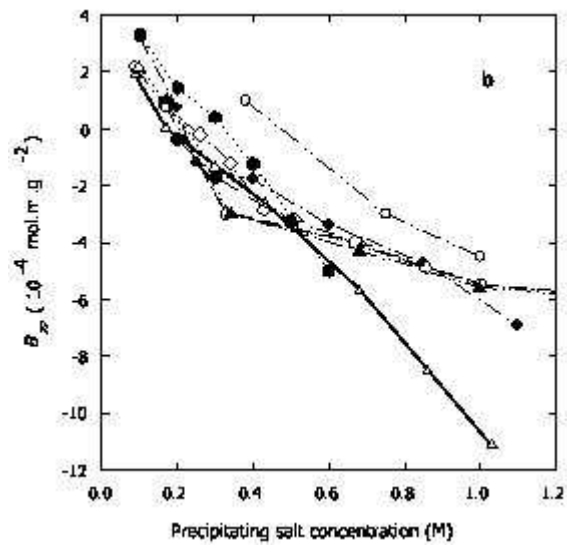

Figure 3. Schematic description of setup used for micro fluidic self-interaction chromatography runs.
244x155mm (300 x 300 DPI)



112x99mm (72 x 72 DPI)



103x99mm (72 x 72 DPI)

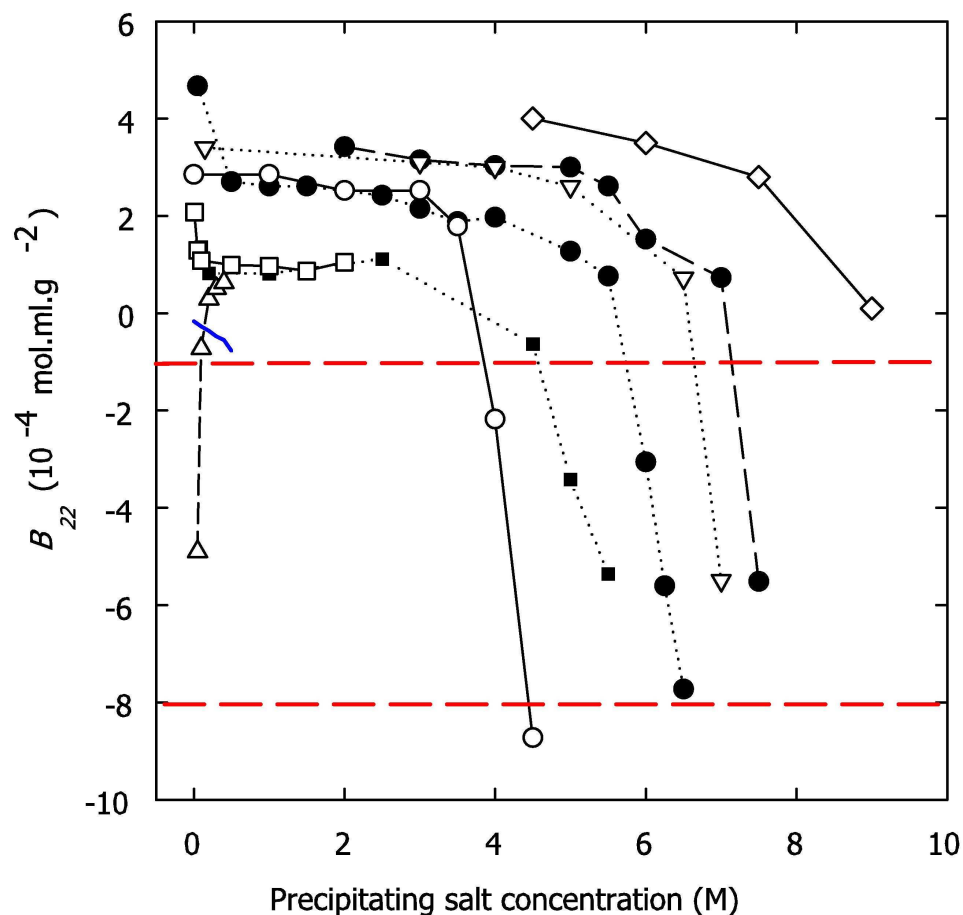

Figure 5: Osmotic second virial coefficients (B_{22}) as a function of precipitating salt concentration. Dashed red lines denote the upper and lower boundaries of the crystallization slot. Myoglobin at pH 7.4 (white circle with solid line) [29]; myoglobin at pH 7.0 (black circle with dotted line) [29]; myoglobin at pH 6.0 (black circle with short dash line) [29]; BSA at pH 7.0 (white square with solid line) [71]; BSA at pH 6.2 (black square with dotted line) [71]; chymotrypsinogen at pH 6.8 (white triangle with short dash line) [34]; malate dehydrogenase at pH 8.0 (white diamond with solid line) [72]; ovalbumin at pH 6.0 (white inverted triangle with dotted line) [70]; peptide "Enfuvirtide" at pH 9.0 (solid blue line, no symbols) [38].
115x117mm (600 x 600 DPI)

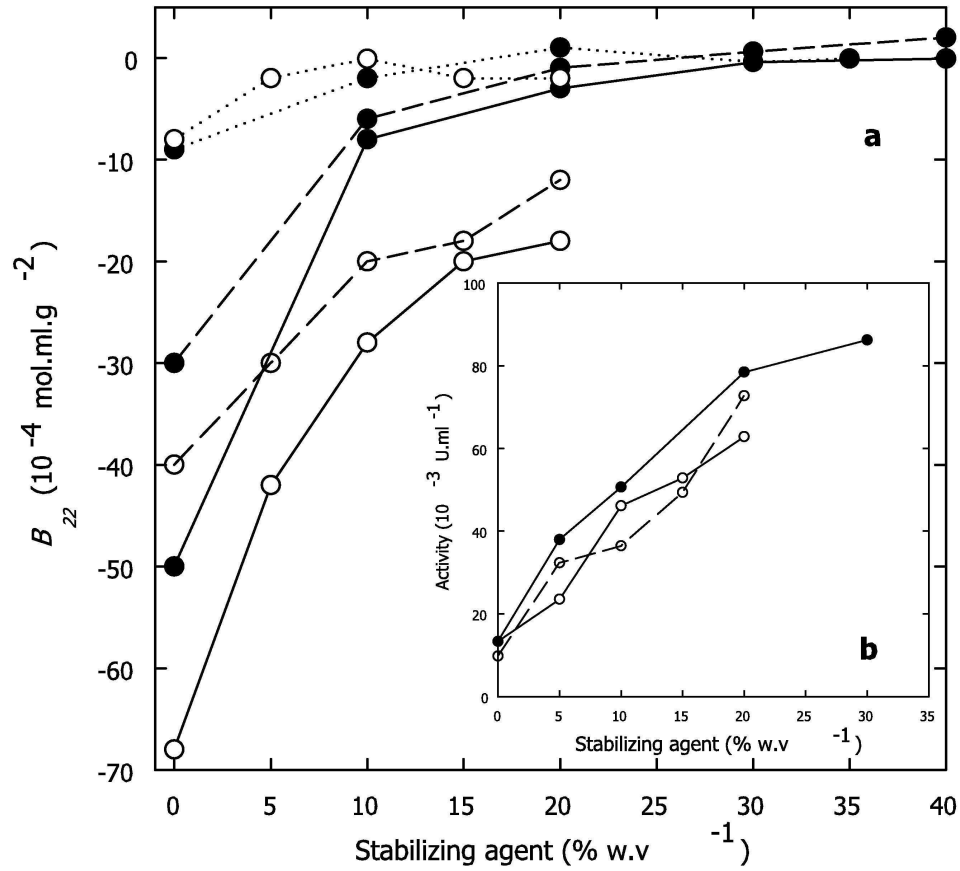

Figure 6 (a) Effect of stabilizing agents on Amylase osmotic second virial coefficient (B_{22}) values estimated by SIC. (b) Activity of Amylase as a function of stabilizing agents. Sucrose (black circles) and Sorbitol (white circles); 1% (w/v) NaCl at pH 6.00 (dotted line); 5% (w/v) NaCl at pH 4.43 (short dash line); and 1% (w/v) NaCl at pH 4.53 (solid line) [39].
118x115mm (600 x 600 DPI)

Short CV Marcel Ottens

Marcel Ottens received his MSc in Bio- Chemical Engineering from Groningen University, his Professional Doctorate in Engineering on Process Design from Twente University, and his PhD in Chemical Engineering from Amsterdam University on a topic on Transport Phenomena (the Netherlands). He is currently Assistant Professor Bioseparation Technology at the Delft University of Technology (the Netherlands), and group leader Micro BioSystems Technology. He is Visiting Professor at the Beijing University of Chemical Technology and Editor of Food and Bioproducts Processing. He published over 45 peer reviewed scientific papers and holds several patents, presented dozens of (invited) lectures at international conferences. He is board member of the Dutch Biotechnological Society, working party Product Isolation and Purification and member of the EFB (European Federation of Biotechnology), the ACS (American Chemical Society), and the KNCV (Dutch Chemical Society), chairman of the committee on ACS-BIOT – ESBES collaboration. He is (co)organizer of several international conferences (e.g. BPP2005, EFB-DSP2007, ACS-BIOT2009). He is board member of the successful annual International Advanced Course on Downstream Processing (Delft). His current research interests are protein separations; micro bio systems technology & bioprocess miniaturization; fast conceptual bioprocess design; crystallization/precipitation, or more in general phase behavior, of biomaterials; process chromatography (Simulated Moving Bed technology) of biologicals, and more in general transport phenomena and bioseparation science.

