



**HAL**  
open science

# An LPV Control Approach for Semi-active Suspension Control with Actuator Constraints

Anh Lam Do, Olivier Sename, Luc Dugard

► **To cite this version:**

Anh Lam Do, Olivier Sename, Luc Dugard. An LPV Control Approach for Semi-active Suspension Control with Actuator Constraints. ACC 2010 - American Control Conference, Jun 2010, Baltimore, Maryland, United States. hal-00497721

**HAL Id: hal-00497721**

**<https://hal.science/hal-00497721>**

Submitted on 5 Jul 2010

**HAL** is a multi-disciplinary open access archive for the deposit and dissemination of scientific research documents, whether they are published or not. The documents may come from teaching and research institutions in France or abroad, or from public or private research centers.

L'archive ouverte pluridisciplinaire **HAL**, est destinée au dépôt et à la diffusion de documents scientifiques de niveau recherche, publiés ou non, émanant des établissements d'enseignement et de recherche français ou étrangers, des laboratoires publics ou privés.

# An LPV Control Approach for Semi-active Suspension Control with Actuator Constraints

Anh-Lam Do, Olivier Sename and Luc Dugard

**Abstract**—This paper presents a new solution for the semi-active suspension control problem. First, a quarter vehicle model equipped with a semi-active damper is reformulated in the LPV framework using the nonlinear static semi-active damper model. This formulation allows to turn the control problem with dissipativity constraint into that with input saturation. Then the damper force saturation is taken into account in an original LPV fashion. This leads to the definition of a new LPV model with two parameters which is handled in a polytopic way. The  $H_\infty$  control design for polytopic systems is then applied. The interest of the provided methodology is emphasized by simulations on a nonlinear vehicle model.

## I. INTRODUCTION

Suspension systems play a key role in vehicles. A well designed suspension system may considerably improve not only the comfort (vibration insulation of the passengers against road irregularities) but also the road holding (the vehicle road contact). Today semi-active suspensions (like friction, Magneto-Rheological, Electro-Rheological suspension ...) are widely used in automobile industry because of some advantages: small weight and volume, low energy consumption (compared with active suspensions), low price, good performance...

The control design problem for semi-active suspension systems has been tackled with many approaches during the last three decades. One of the first control methods to be applied in commercial vehicles is the Skyhook control [1]. In this linear-model based control design, the damping coefficient is adjusted continuously or switched between a maximum and a minimum value. Recently, the ADD (Acceleration Driven Damping) [2] and the mixed Skyhook-ADD (SH-ADD) [3] algorithms, based on optimal control, have improved the Skyhook technique. Such controllers, however, can only provide a good comfort while neglecting the road holding. On the contrary, the ground-hook controller [4], designed in a similar way to Skyhook controller, improves only the road holding. The vehicle performance can be improved by the hybrid control [5] (combination of skyhook and ground-hook) and by the  $H_\infty$  control [6] since they improve both comfort and road holding.

The controllers above have been proved to enhance the performance of the vehicle. However, the nonlinear characteristic (the bi-viscous and the hysteretic behaviors of semi-active dampers) and especially the dissipativity constraint of a semi-active suspension are not taken into account in the

design strategy. Then a clipped strategy is used to keep the dissipative behavior of the damper, without any performance guarantee [7], [6]. In [8], an LPV approach is proposed in order to satisfy the dissipativity constraint. A scheduling parameter is indeed defined as the difference between the real controlled damper force and the required one given by the controller. The performance objectives are satisfied but the dissipativity constraint is not theoretically fulfilled. Moreover, no damper model is used in the synthesis (only the external forces are taken into account).

The main contribution of the present paper is to propose a new control design method for semi-active suspension which can reach the performance objectives while satisfying the dissipativity constraint. The methodology is based on a nonlinear static model of the semi-active damper, as in [9]. Hence the bi-viscous and hysteretic behaviors of the damper are taken into account. Then, the nonlinear system associated with the quarter vehicle model is reformulated in the LPV framework. The problem of dissipativity is then brought into the problem of input saturation. To solve the input saturation problem, a new design method is proposed that allows integrating the saturation actuator in the initial system to create a new LPV system. The LPV controller is then synthesized using the well-known results given in [10] and [11]. The advantage of this method is that the control input always meets the saturation constraint and hence the dissipativity constraint is fulfilled.

This paper is organized as follows. In Section II, the LPV model for the quarter car with MR damper is developed. Then, a new solution for the problem of dissipativity constraint is proposed in Section III. In Section IV, some outlines about the  $H_\infty$  control for polytopic systems are presented and a controller for semi-active suspension is designed. In Section V, the results obtained in simulations with a nonlinear quarter car model are discussed. Finally, some conclusions and perspectives are drawn in Section VI.

## II. PROBLEM FORMULATION

### A. System description

Consider a simple model of quarter vehicle (see Fig. 1) made up of a sprung mass ( $m_s$ ) and an unsprung mass ( $m_{us}$ ). A spring with the stiffness coefficient  $k_s$  and a semi-active damper connect these two masses. The wheel tire is modeled by a spring with the stiffness coefficient  $k_t$ . In this model,  $z_s$  (respectively  $z_{us}$ ) is the vertical position of  $m_s$  (respectively  $m_{us}$ ) and  $z_r$  is the road profile. It is assumed that the wheel-road contact is ensured.

The dynamical equations of a quarter vehicle are governed

The authors are with GIPSA-lab, Control Systems Dept, CNRS-Grenoble INP, ENSE3, BP 46, F-38402 St Martin d'Hères cedex, France {anh-lam.do, olivier.sename, luc.dugard}@gipsa-lab.grenoble-inp.fr

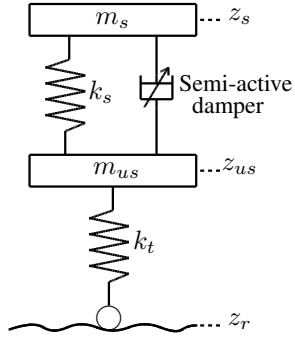

Fig. 1. Model of quarter vehicle with a semi-active damper.

by:

$$\begin{cases} m_s \ddot{z}_s = -F_{spring} - F_{mr} \\ m_{us} \ddot{z}_{us} = F_{spring} + F_{mr} - k_t(z_{us} - z_r) \end{cases} \quad (1)$$

$F_{spring} = k_s z_{def}$  : spring force.

$z_{def} = z_s - z_{us}$  : damper deflection (assumed to be measured or estimated).

$\dot{z}_{def} = \dot{z}_s - \dot{z}_{us}$  : deflection velocity (can be directly computed from  $z_{def}$ ).

In this paper, the behavior of the semi-active suspension is represented using the following nonlinear equation, as in [9]):

$$F_{mr} = a_2 \left( \dot{z}_{def} + \frac{v_0}{x_0} z_{def} \right) + a_1 \tanh \left( a_3 \left( \dot{z}_{def} + \frac{v_0}{x_0} z_{def} \right) \right) \quad (2)$$

where  $a_2$ ,  $a_3$ ,  $v_0$  and  $x_0$  are constant parameters and  $a_1$  is varying according to the electrical current in coil ( $0 < a_{1min} \leq a_1 \leq a_{1max}$ ). This model allows fulfilling the dissipativity constraint of the semi-active damper.

In the following, in order to better emphasize the controllable property of the damper,  $a_1$  will be denoted as the control input, and for simplicity, the damping and stiffness parameters are defined respectively by:

- $c_{mr} = a_2$  : damper damping coefficient
- $k_{mr} = a_2 \frac{v_0}{x_0}$  : damper stiffness coefficient

The quarter vehicle using in this paper is the "Renault Mégane Coupé" model (see [12]) whose specific parameters are:  $m_s = 315$  kg,  $m_{us} = 37.5$  kg,  $k_s = 29500$  N/m,  $k_t = 210000$  N/m.

The damper model parameters have been chosen according to the MR damper in [13]:  $a_2 = 1500$  Ns/m,  $a_3 = 129$  s/m,  $v_0 = 0.788 \times 10^{-3}$  m/s,  $x_0 = 1.195 \times 10^{-3}$  m,  $F_0 = 200$  N.

### B. LPV model formulation

The nonlinear model (1)-(2) is now rewritten in the LPV framework. Indeed, denoting:

$$\rho_1 = \tanh \left( a_3 \left( \dot{z}_{def} + \frac{v_0}{x_0} z_{def} \right) \right) \quad (3)$$

the following state-space representation of the quarter-car model can be deduced as follows:

$$\begin{cases} \dot{x}_s = A_s x_s + B_s \rho_1 a_1 + B_{s1} w \\ y = C_s x_s \end{cases} \quad (4)$$

where

$x_s = (z_s, \dot{z}_s, z_{us}, \dot{z}_{us})^T$ ,  $w = z_r$ ,  $y = z_s - z_{us}$  measured output.

$$A_s = \begin{pmatrix} 0 & 1 & 0 & 0 \\ -\frac{k_s + k_{mr}}{m_s} & -\frac{c_{mr}}{m_s} & \frac{k_s + k_{mr}}{m_s} & \frac{c_{mr}}{m_s} \\ 0 & 0 & 0 & 1 \\ \frac{k_s + k_{mr}}{m_{us}} & \frac{c_{mr}}{m_{us}} & -\frac{k_s + k_{mr} + k_t}{m_{us}} & -\frac{c_{mr}}{m_{us}} \end{pmatrix}$$

$$B_s = \begin{pmatrix} 0 \\ -\frac{1}{m_s} \\ 0 \\ \frac{1}{m_{us}} \end{pmatrix}, B_{s1} = \begin{pmatrix} 0 \\ 0 \\ 0 \\ \frac{k_t}{m_{us}} \end{pmatrix}, C_s = \begin{pmatrix} 1 \\ 0 \\ -1 \\ 0 \end{pmatrix}^T$$

### C. Model reformulation

As explained above, the control signal  $a_1$  must be positive ( $0 < a_{1min} \leq a_1 \leq a_{1max}$ ) so that the dissipativity constraint is satisfied. The positivity problem can be solved by defining  $u = a_1 - F_0$  where  $F_0$  is the mean value of  $a_1$  (i.e  $F_0 = (a_{1min} + a_{1max})/2$ ). The positivity constraint of  $a_1$  is recast as a saturation constraint on  $u$  ( $u$  can take values in  $[-F_0; +F_0]$  only). With this modification, the state-space representation of quarter vehicle is given as follows:

$$P : \begin{cases} \dot{x}_s = (A_s + B_{s2} \frac{\rho_1}{C_{s2} x_s} C_{s2}) x_s + B_s \rho_1 u + B_{s1} w \\ y = C_s x_s \end{cases} \quad (5)$$

where

$$B_{s2} = \begin{pmatrix} 0; -\frac{F_0}{m_s}; 0; \frac{F_0}{m_{us}} \end{pmatrix}^T,$$

$$C_{s2} = \begin{pmatrix} \frac{a_3 v_0}{x_0}; a_3; -\frac{a_3 v_0}{x_0}; -a_3 \end{pmatrix}^T$$

Note that the term  $c_{mr} \dot{z}_{def} + k_{mr} z_{def} + F_0 \rho_1$  corresponds to a nominal MR damper force ( $u = 0$ ).

## III. TOWARD A CONTROL ORIENTED LPV MODEL ACCOUNTING FOR INPUT SATURATION

### A. Ideal linear design

In (5) the control input matrix  $B_s \rho_1$  is parameter dependent, which is not consistent with the solution of the  $H_\infty$  design problem for polytopic systems [10]. This problem can be easily solved by adding a strictly proper filter into Eq. (5) to make the controlled input matrix independent from the scheduling parameter (see [14]):

$$F : \begin{pmatrix} \dot{x}_f \\ u \end{pmatrix} = \begin{pmatrix} A_f & B_f \\ C_f & 0 \end{pmatrix} \begin{pmatrix} x_f \\ u_c \end{pmatrix} \quad (6)$$

where  $A_f$ ,  $B_f$ ,  $C_f$  are constant matrices.

From Eq. (5) and Eq. (6) and denoting  $\rho_2 = \frac{\rho_1}{C_{s2} x_s}$ , the control oriented model is now represented by an LPV system with two scheduling parameters  $\rho_1$  and  $\rho_2$  (notice that  $\rho_1$  and  $\rho_2$  are not independent):

$$\begin{cases} \dot{x} = A(\rho_1, \rho_2) x + B u_c + B_1 w \\ y = C x \end{cases} \quad (7)$$

where

$$x = \begin{pmatrix} x_s^T & x_f^T \end{pmatrix}^T$$

$$A(\rho_1, \rho_2) = \begin{pmatrix} A_s + \rho_2 B_{s2} C_{s2} & \rho_1 B_s C_f \\ 0 & A_f \end{pmatrix},$$

$$B = \begin{pmatrix} 0 \\ B_f \end{pmatrix}, B_1 = \begin{pmatrix} B_{s1} \\ 0 \end{pmatrix}, C = \begin{pmatrix} C_s \\ 0 \end{pmatrix}^T$$

$$\rho_1 = \tanh(C_{s2} x_s) \in [-1; 1]$$

$$\rho_2 = \frac{\tanh(C_{s2} x_s)}{C_{s2} x_s} \in [0; 1]$$

In this study, the LPV model (7) is used to design a polytopic (LPV) controller considering the convex set of bounded parameters  $(\rho_1, \rho_2)$ . However, such a controller may not ensure the closed-loop performances since the saturation constraint (i.e the dissipativity constraint) is not accounted for in the controller design. Some solutions for this problem have been proposed. For example, in [8], a scheduling parameter is indeed defined as the difference between the real controlled damper force and the required one given by the controller. However the dissipativity constraint is not theoretically fulfilled. Another possible method is to add in the closed-loop system an AWBT (Anti Wind-up Bumpless Transfer) compensation (may be also of the form LPV) to minimize the adverse effects of the control input saturation on the closed-loop performance. In the next section, a simple method to solve the control problem with input saturation will be proposed.

#### B. A new solution for the problem of input saturation

First the system (7) (made up of a filter and a quarter vehicle) is augmented by adding a saturated actuator as in Fig. 2. where

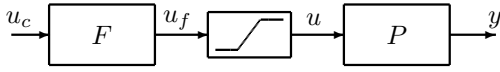

Fig. 2. Linear design with input saturation.

$$u = \text{sat}(u_f) = \begin{cases} F_0 & \text{if } u_f > F_0 \\ u_f & \text{if } -F_0 \leq u_f \leq F_0 \\ -F_0 & \text{if } u_f < -F_0 \end{cases} \quad (8)$$

To cope with a linear control design, the saturation function  $\text{sat}(u_f)$  is roughly approximated by a tangent hyperbolic function:  $F_0 \tanh(\frac{u_f}{F_0})$  or  $F_0 \tanh(\frac{C_f x_f}{F_0})$ . The state-space representation of the transfer function from  $u_c$  to  $u$  is then:

$$F_1 : \begin{pmatrix} \dot{x}_f \\ u \end{pmatrix} = \begin{pmatrix} A_f & B_f \\ C_f \rho_3 & 0 \end{pmatrix} \begin{pmatrix} x_f \\ u_c \end{pmatrix} \quad (9)$$

$$\text{where } \rho_3 = \frac{\tanh(\alpha)}{\alpha} \text{ and } \alpha = \frac{C_f x_f}{F_0}$$

This leads to a slight modification of model (7) with new scheduling parameters  $\rho_1^* = \rho_1 \rho_3$  and  $\rho_2^* = \rho_2$ :

$$\begin{cases} \dot{x} = A(\rho_1^*, \rho_2^*) x + B u_c + B_1 w \\ y = C x \end{cases} \quad (10)$$

Notice also that  $\rho_1^*$  and  $\rho_2^*$  are not independent.

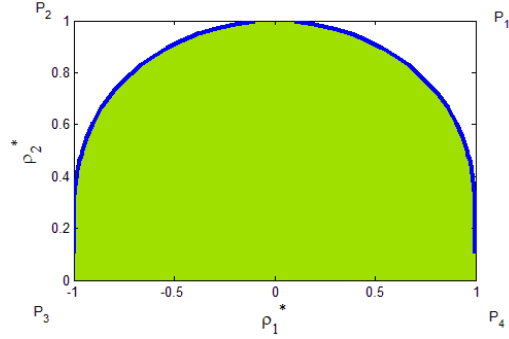

Fig. 3. Set of  $(\rho_1^*, \rho_2^*)$  (shade area + curved line) and set of  $(\rho_1, \rho_2)$  (curved line).

## IV. CONTROLLER SYNTHESIS

In order to improve the driving comfort (see [8]), the frequency response of the vehicle body acceleration  $\ddot{z}_s/z_r$  must be kept small in the frequency range [0.5-10] Hz. For the road holding, the frequency responses of  $z_{us}/z_r$  must be small in [0-20] Hz. The frequency response of  $z_{def}/z_r$  should be small in [0-20] Hz to keep the damper deflection far from the structural limits. To make a controller satisfying these objectives, the  $H_\infty$  design method for LPV systems is used.

#### A. LPV systems and $H_\infty$ controller

*Definition 1:* LPV generalized system.

A dynamical LPV system can be described in the following form:

$$\Sigma(\theta) : \begin{pmatrix} \dot{x} \\ z \\ y \end{pmatrix} = \begin{pmatrix} A(\theta) & B_1(\theta) & B_2(\theta) \\ C_1(\theta) & D_{11}(\theta) & D_{12}(\theta) \\ C_2(\theta) & D_{21}(\theta) & D_{22}(\theta) \end{pmatrix} \begin{pmatrix} x \\ w \\ u \end{pmatrix} \quad (11)$$

where  $x$ ,  $w$  and  $u$  define the state, the exogenous and control input, respectively;  $z$  and  $y$  hold for the controlled output and system measure, respectively.  $\theta(\cdot) \in \Theta$  is the set of varying parameters that describe a set of systems.  $A \in \mathbb{R}^{n \times n}$ ,  $B_1 \in \mathbb{R}^{n \times n_w}$ ,  $B_2 \in \mathbb{R}^{n \times n_u}$ ,  $C_1 \in \mathbb{R}^{n_z \times n}$ ,  $D_{11} \in \mathbb{R}^{n_z \times n_w}$ ,  $D_{12} \in \mathbb{R}^{n_z \times n_u}$ ,  $C_2 \in \mathbb{R}^{n_y \times n}$ ,  $D_{21} \in \mathbb{R}^{n_y \times n_w}$  and  $D_{22} \in \mathbb{R}^{n_y \times n_u}$  are affine in  $\theta$ .

*Definition 2:*  $H_\infty$  LPV controller.

An LPV controller is defined by

$$K(\theta) : \begin{pmatrix} \dot{x}_c \\ u \end{pmatrix} = \begin{pmatrix} A_c(\theta) & B_c(\theta) \\ C_c(\theta) & D_c(\theta) \end{pmatrix} \begin{pmatrix} x_c \\ y \end{pmatrix} \quad (12)$$

where  $x_c$ ,  $y$  and  $u$  are the state, the input and output of the controller, respectively, of the controller associated to the system (11).  $\theta(\cdot) \in \Theta$  is the set of the varying parameters associated to the controller.  $A_c \in \mathbb{R}^{n_c \times n_c}$ ,  $B_c \in \mathbb{R}^{n_c \times n_y}$ ,  $C_c \in \mathbb{R}^{n_u \times n_c}$  and  $D_c \in \mathbb{R}^{n_u \times n_y}$ .

The  $H_\infty$  control problem for the LVP system  $\Sigma(\theta)$  consists in finding an LPV controller  $K(\theta)$  such that the closed-loop system is quadratically stable and that, for a given positive real  $\gamma$ , the  $L_2$ -induced norm of the operator mapping  $w$  into  $z$  is bounded by  $\gamma$  for all possible trajectories of  $\theta$ .

The LPV controller is obtained by solving an LMI problem. See the detail of this algorithm in [10] and [11] or

in the PhD thesis [14]. For a polytopic set of parameters, the solution of the previous LMIs problem at each vertex of the polytope will give a controller. The convex combination of these controllers results in the global controller for LPV systems.

$$K(\theta) = Co\left\{ \begin{pmatrix} A_{c_k} & B_{c_k} \\ C_{c_k} & D_{c_k} \end{pmatrix} \right\} \quad (13)$$

where  $k = 1 : 2^i$ ,  $i$  is the number of vertices of the polytope,  $\begin{pmatrix} A_{c_k} & B_{c_k} \\ C_{c_k} & D_{c_k} \end{pmatrix}$  is the controller corresponding to the  $k^{th}$  vertex (see [14] for more details).

### B. Controller design for semi-active suspension

The considered control configuration is given in Fig. 4. With the performance objectives mentioned previously, the controlled output vector is  $z = (\ddot{z}_s, z_{us})^T$ . The generalized system for the LPV controller synthesis is as follows:

$$\begin{cases} \dot{x} = A(\rho_1^*, \rho_2^*)x + Bu_c + B_1w \\ z = C_1(\rho_1^*, \rho_2^*)x \\ y = Cx \end{cases} \quad (14)$$

where

$$\begin{aligned} x &= \begin{pmatrix} x_s & x_f \end{pmatrix}^T \\ A(\rho_1^*, \rho_2^*) &= \begin{pmatrix} A_s + \rho_2^* B_{s2} C_{s2} & \rho_1^* B_s C_f \\ 0 & A_f \end{pmatrix}, \\ B &= \begin{pmatrix} 0 \\ B_f \end{pmatrix}, B_1 = \begin{pmatrix} B_{s1} \\ 0 \end{pmatrix} \\ C_1(\rho_1^*, \rho_2^*) &= \begin{pmatrix} C_{s1} & \rho_1^* D_{s1} C_f \end{pmatrix}, C = \begin{pmatrix} C_s & 0 \end{pmatrix} \\ C_{s1} &= \begin{pmatrix} -\frac{k_s + k_{mr}}{m_s} & -\frac{c_{mr}}{m_s} & \frac{k_s + k_{mr}}{m_s} & \frac{c_{mr}}{m_s} \\ 0 & 0 & 1 & 0 \end{pmatrix} \\ D_{s1} &= \begin{pmatrix} -\frac{1}{m_s} \\ 0 \end{pmatrix} \quad C_s = \begin{pmatrix} 1 & 0 & -1 & 0 \end{pmatrix} \end{aligned}$$

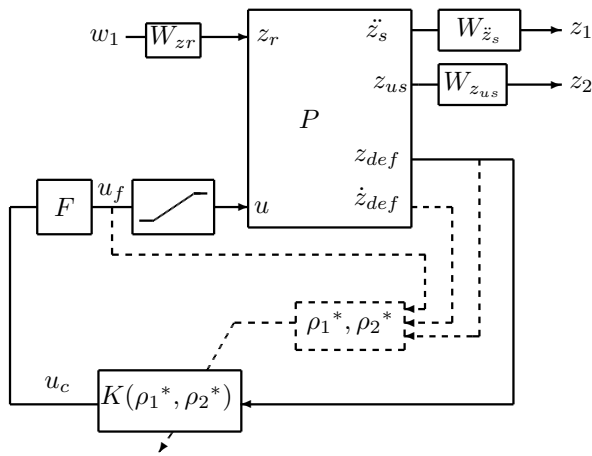

Fig. 4. Block diagram for semi-active suspension control.

Note that  $F(s) = \frac{50}{s+50}$  is chosen with a sufficiently large bandwidth.

To account for performance specifications, some weighting functions are added as usual in the  $H_\infty$  control approach.  $W_{\ddot{z}_s}$  and  $W_{z_{us}}$  have been chosen to emphasize frequencies up to 20 Hz and to reduce the peaks around 16 Hz for  $z_{us}$  and  $z_{def}$ .

$$\begin{aligned} W_{\ddot{z}_s} &= \frac{s^2 + 2\xi_{11}\Omega_1 s + \Omega_1^2}{s^2 + 2\xi_{12}\Omega_1 s + \Omega_1^2}, \\ W_{z_{us}} &= \frac{s^2 + 2\xi_{21}\Omega_2 s + \Omega_2^2}{s^2 + 2\xi_{22}\Omega_2 s + \Omega_2^2}, \quad W_{z_r} = 3 \times 10^{-2} \end{aligned}$$

where  $\Omega_1 = 2\pi f_1$  with  $f_1 = 20$  Hz,  $\xi_{11} = 20$ ,  $\xi_{12} = 1$ ,  $\Omega_2 = 2\pi f_2$  with  $f_2 = 11$  Hz,  $\xi_{21} = 20$ ,  $\xi_{22} = 1$ .

Due to the self-dependence between  $\rho_1$  and  $\rho_2$ , the set of parameters  $(\rho_1^*, \rho_2^*)$  is not a polytope as seen in Fig. 3. In this preliminary study,  $\rho_1^*$  and  $\rho_2^*$  are considered as independent parameters and  $(\rho_1^*, \rho_2^*)$  belongs to a larger polytope whose vertices are  $P_1 = (1, 1)$ ,  $P_2 = (-1, 1)$ ,  $P_3 = (-1, 0)$ ,  $P_4 = (1, 0)$ . A controller for this LPV system is easily found by applying the  $H_\infty$  design method - polytopic approach presented above.

## V. SIMULATION AND RESULTS

For the simulation, the spring force  $F_{spring}$  is a nonlinear function of  $z_{def}$  (see [12] for more details). In the following, the different cases are considered for the performance evaluation of the proposed methodology:

- Passive = Renault Mégane Car equipped with an optimized passive damper.
- SH-ADD = Renault Mégane Car equipped with a semi-active damper whose damping coefficient is tuned by the SH-ADD strategy (see [3]).
- $H_\infty$ /LPV Control = Renault Mégane Car equipped with a semi-active damper controlled by the proposed methodology.

### A. Frequency domain analysis

The criterion used for the evaluation is the power spectral density (PSD) measure of the frequency responses  $(\ddot{z}_s/z_r, z_{us}/z_r, z_{def}/z_r)$  according to a sinusoidal road profile of magnitude  $z_r = \pm 1.5cm$  whose frequency is varying (see [6]).

$$PSD_{f_1 \rightarrow f_2}(x) = \int_{f_1}^{f_2} x(f) df \quad (15)$$

Let us recall that the performance objectives are as follows:

- *Comfort*: decrease the gain of  $\ddot{z}_s/z_r$  over [0.5-10] Hz.
- *Road holding*: decrease the gain of  $z_{us}/z_r$  over [0-20] Hz.
- *Suspension stroke*: limit the gain of  $z_{def}/z_r$  over [0-20] Hz.

Signal	Passive PSD	$I_p$ : Performance improvement in %	
		SH-ADD	$H_\infty$ /LPV
$\ddot{z}_s/z_r$	234.7	50.6%	17.7%
$z_{us}/z_r$	1.089	-1.6%	7.9%
$z_{def}/z_r$	1.066	14.5%	16.2%

TABLE I  
COMPARISON WITH PASSIVE SUSPENSION.

In Tab. I, the comparison of the PSD criteria is made w.r.t the passive case as follows:

$$I_p = \frac{\text{passive PSD} - X \text{ PSD}}{\text{passive PSD}} \quad (16)$$

where  $X$  stands either for SH-ADD or  $H_\infty/LPV$  control methods. Notice that  $I_p > 0$  means that there is an improvement w.r.t the passive case and  $I_p < 0$ , a deterioration, in terms of performance.

As seen in Fig. 5-7 and Tab. I, the frequency response  $\ddot{z}_s/z_r$  (the comfort) in the  $H_\infty/LPV$  case is better than that in the passive case but worse than that in the case using the SH-ADD strategy (which is known to be comfort oriented). For the road holding, the frequency response  $z_{us}/z_r$  in the  $H_\infty/LPV$  case is better than that in both the passive and the SH-ADD cases. The peak value of the gain of  $z_{us}/z_r$  in the  $H_\infty/LPV$  case is sharply reduced comparing to those in both other cases. The suspension stroke ( $z_{def}$ ) is also improved in the sense that it is much better than in the passive case and slightly better than in the SH-ADD case.

### B. Time domain analysis

In the time domain simulation,  $z_r$  is a uniformly distributed random signal with amplitude between [-2.0 cm ; 2.0 cm] and period of 0.5 s. The vehicle responses ( $\ddot{z}_s$ ,  $z_s$ ,  $z_{us}$ ,  $z_{def}$ ) are compared between the different strategies and respectively given in Fig. 11-14. The proposed  $H_\infty/LPV$  methodology allows getting globally much better performances than the passive and SH-ADD suspensions, improving comfort and road holding. As shown in Fig. 8, the input force  $u$  provided by the semi-active controller is within the range [-200 N ; +200 N]. The damper force  $F_{mr}$  then satisfies the dissipativity constraint thanks to the  $H_\infty/LPV$  methodology (see Fig. 9). Finally, the scheduling parameters  $\rho_1^*$ ,  $\rho_2^*$  mostly vary for significant changes of  $z_r$  to allow for controller adaptation.

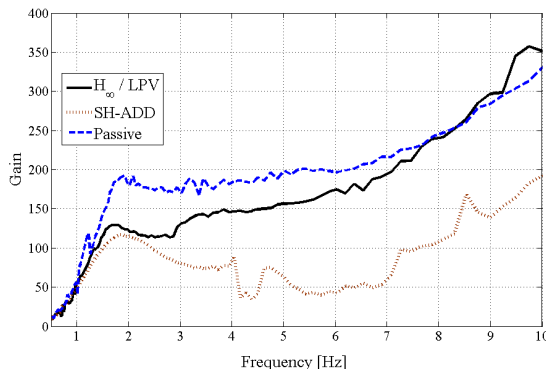

Fig. 5. Nonlinear frequency responses  $\ddot{z}_s/z_r$ .

## VI. CONCLUSION

In this paper, a new method for semi-active suspension control was proposed. An LPV model for a quarter vehicle with a semi-active damper is formulated and an LPV controller is synthesized to improve the driving comfort and the road holding capability in the frequency range of interest respectively. The results in the frequency and time domains have shown that the performance objectives can be reached while satisfying the dissipativity constraint of the damper.

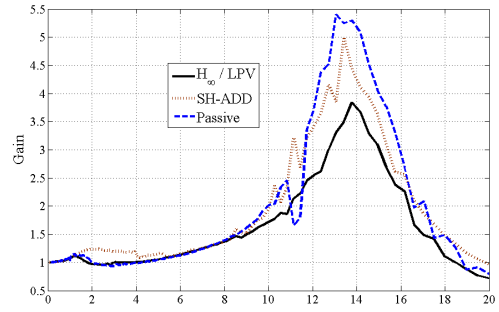

Fig. 6. Nonlinear frequency responses  $z_{us}/z_r$ .

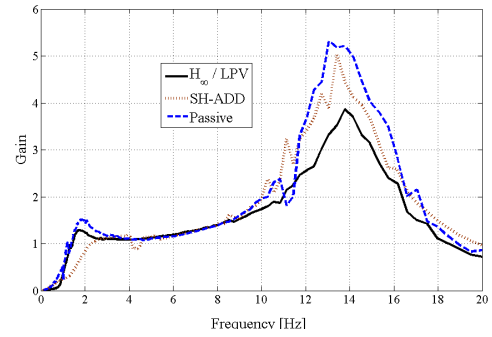

Fig. 7. Nonlinear frequency responses  $z_{def}/z_r$ .

In future works, to enhance the performance, the reduction of the conservatism in the controller design will be considered. The variation of the semi-active damper parameters ( $a_3$ ,  $v_0$ ,  $x_0$  and specially  $a_2$ ) will be taken into account to well adapt the controller to real applications.

## REFERENCES

- [1] D. Karnopp, M. Crosby, and R. Harwood, "Vibration control using semi-active force generators," *Journal of Engineering for Industry*, vol. 96, pp. 619–626, 1974.
- [2] S. Savaresi, S. Bittanti, and M. Montiglio, "Identification of semi-physical and black-box models: the case of MR-dampers for vehicles control," *Automatica*, vol. 41, pp. 113–117, 2005.
- [3] S. Savaresi and C. Spelta, "Mixed sky-hook and ADD: Approaching the filtering limits of a semi-active suspension," *ASME Transactions: Journal of Dynamic Systems, Measurement and Control*, vol. 129, no. 4, pp. 382–392, 2007.
- [4] M. Valasek, M. Novak, Z. Sika, , and O. Vaculin, "Extended ground-hook new concept of semi-active control of trucks suspension," *Vehicle System Dynamics*, vol. 29, pp. 289–303, 1997.
- [5] B. A. Gven, E. Kural, B. Kesli, K. Glibudak, S. Gngr, and A. Kanbolat, "Semi active suspension control system development for a light commercial vehicle," in *presented at the IFAC Conf. Mechatron. Syst., Heidelberg, Germany, 2006*.
- [6] D. Sannier, O. Sename, and L. Dugard, "Skyhook and  $\mathcal{H}_\infty$  control of active vehicle suspensions: some practical aspects," *Vehicle System Dynamics*, vol. 39, no. 4, pp. 279–308, april 2003.
- [7] D. Karnopp, "Active damping in road vehicle suspension systems," *Vehicle System Dynamics*, vol. 12, no. 6, pp. 296–316, 1983.
- [8] C. Poussot-Vassal, O. Sename, L. Dugard, P. Gáspár, Z. Szabó, and J. Bokor, "New semi-active suspension control strategy through LPV technique," *Control Engineering Practice*, vol. 16, no. 12, pp. 1519–1534, December 2008.
- [9] S. Guo, S. Yang, and C. Pan, "Dynamic modeling of magnetorheological damper behaviors," *Journal of Intelligent Material Systems And Structures*, vol. 17, pp. 3–14, January 2006.

- [10] P. Apkarian and P. Gahinet, "A convex characterization of gain scheduled  $\mathcal{H}_\infty$  controllers," *IEEE Transaction on Automatic Control*, vol. 40, no. 5, pp. 853–864, may 1995.
- [11] C. Scherer, P. Gahinet, and M. Chilali, "Multiobjective output-feedback control via LMI optimization," *IEEE Transaction on Automatic Control*, vol. 42, no. 7, pp. 896–911, july 1997.
- [12] A. Zin, O. Sename, M. Basset, L. Dugard, and G. Gissingner, "A nonlinear vehicle bicycle model for suspension and handling control studies," in *Proceedings of the IFAC Conference on Advances in Vehicle Control and Safety (AVCS)*, Genova, Italy, october 2004, pp. 638–643.
- [13] E. Nino-Juarez, R. Morales-Menendez, R. Ramirez-Mendoza, and L. Dugard, "Minimizing the frequency in a black box model of a mr damper," in *11th Mini Conf on Vehicle Sys. Dyn., Ident. and Anomalies*, Budapest, Hungary, 2008.
- [14] C. Poussot-Vassal, "Robust multivariable linear parameter varying automotive global chassis control," PhD Thesis (in English), Grenoble INP, GIPSA-lab, Control System dpt., Grenoble, France, September 2008.

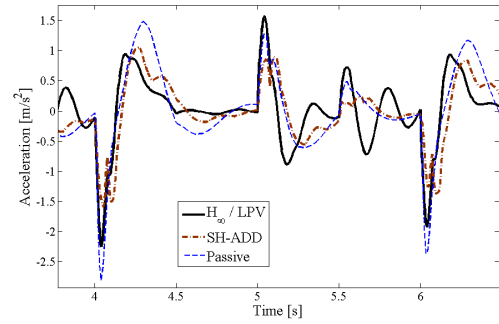

Fig. 11. Time reponses  $\ddot{z}_s$ .

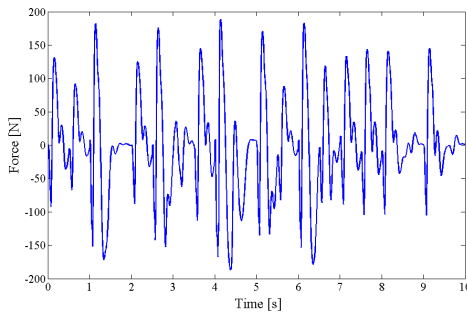

Fig. 8. Control input  $u$ .

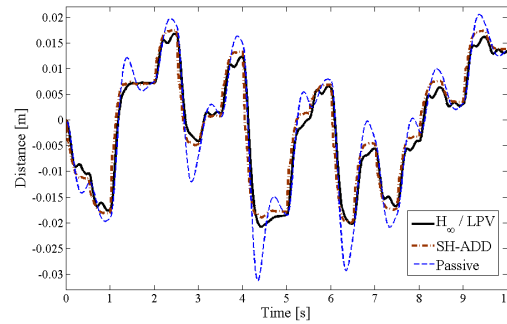

Fig. 12. Time reponses  $z_s$ .

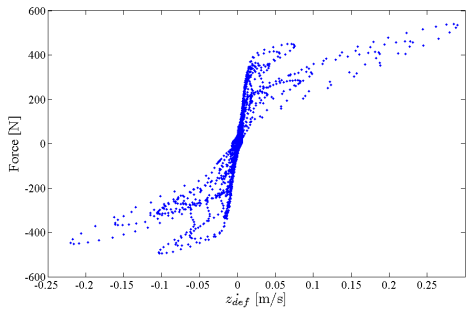

Fig. 9. MR damper force  $F_{mr}$  versus deflection velocity.

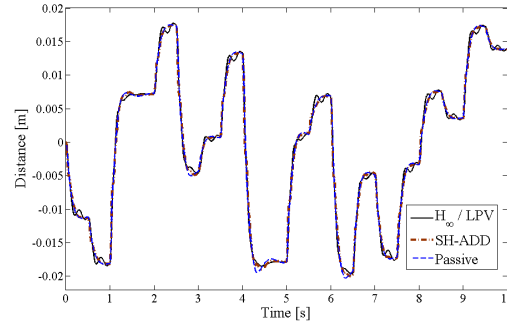

Fig. 13. Time reponses  $z_{us}$ .

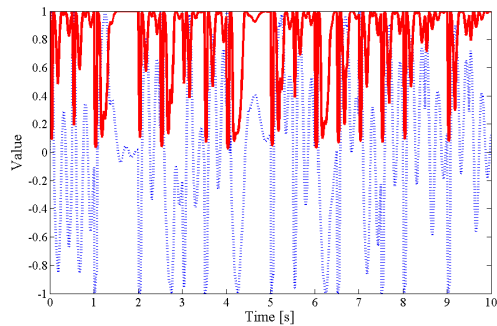

Fig. 10. Scheduling parameters  $\rho_1^*$  and  $\rho_2^*$ .

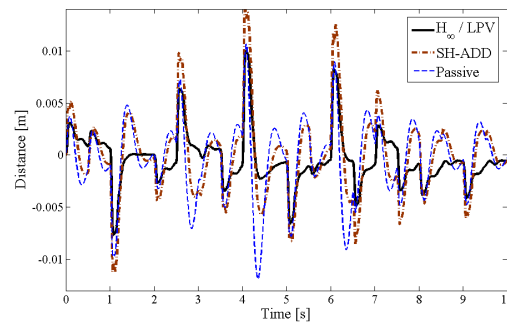

Fig. 14. Time reponses  $z_{def}$ .