



**HAL**  
open science

## Colorless Components for WDM-based Optical Access Networks

Quoc Thai Nguyen, Gwenaëlle Girault, Olivier Vaudel, Laurent Bramerie, Pascal Besnard, Alexandre Shen, Guang-Hua Duan, Christophe Kazmierski, Sebastien Lobo, Michel Joindot, et al.

► **To cite this version:**

Quoc Thai Nguyen, Gwenaëlle Girault, Olivier Vaudel, Laurent Bramerie, Pascal Besnard, et al.. Colorless Components for WDM-based Optical Access Networks. International Workshop on Photonics and Applications 2008 (IWPA 2008), Sep 2008, Nha Trang, Vietnam. pp.B-45. hal-00497253

**HAL Id: hal-00497253**

**<https://hal.science/hal-00497253v1>**

Submitted on 2 Jul 2010

**HAL** is a multi-disciplinary open access archive for the deposit and dissemination of scientific research documents, whether they are published or not. The documents may come from teaching and research institutions in France or abroad, or from public or private research centers.

L'archive ouverte pluridisciplinaire **HAL**, est destinée au dépôt et à la diffusion de documents scientifiques de niveau recherche, publiés ou non, émanant des établissements d'enseignement et de recherche français ou étrangers, des laboratoires publics ou privés.

# Colorless components for WDM-based optical access networks

Q.-T. Nguyen<sup>1</sup>, G. Girault<sup>1</sup>, O. Vaudel<sup>1</sup>, L. Bramerie<sup>1</sup>, P. Besnard<sup>1</sup>, A. Shen<sup>2</sup>, G.H. Duan<sup>2</sup>, C. Kazmierski<sup>2</sup>, S. Lobo<sup>1</sup>, M. Joindot<sup>1</sup>, J.-C. Simon<sup>1</sup>, N. Dupuis<sup>2</sup>, A. Garreau<sup>2</sup>, Z. Belfqih<sup>3</sup>, P. Chanclou<sup>3</sup>

<sup>1</sup>*FOTON-ENSSAT, CNRS UMR 6082, 6 rue de Kerampont, BP 80518, 22305 Lannion Cedex*

<sup>2</sup>*Alcatel Thales III-V Lab. Route de Nozay, 91460 Marcoussis*

<sup>3</sup>*France Telecom - Orange Labs, 2 avenue Pierre Marzin, 22307 Lannion*

[quochai.nguyen@enssat.fr](mailto:quochai.nguyen@enssat.fr)

## ABSTRACT

This paper presents our work carried out in the colorless-component technologies for high bit-rate optical access networks, which are based on WDM-PON (wavelength division multiplexed passive optical networks). The colorless concept consists in using identical and wavelength-independent components that will act as the generic transmitter in WDM-PON systems. The transmitted wavelength is imposed, for each colorless component, by an external optical signal. Our studies include two types of colorless components: The Injection-Locked Fabry-Perot laser (IL-FP) and the Reflective Electro-Absorption Modulator integrated with a Semiconductor Optical Amplifier (REAM-SOA). For the IL-FP, the properties of the component strongly depend on the injected optical signal. We demonstrate the improvement by injection-locking of the laser's performances in terms of intensity noise, chirp and bandwidth. For the REAM-SOA, the static properties such as reflection gain and noise characteristic are examined. We demonstrate the feasibility of the REAM-SOA in a transmission experiment in a PON configuration at 10 Gbps with up to 25 km of SMF, using remote modulation technique.

**Keywords:** Injection-Locked Fabry-Perot Laser, Amplified Reflective Electro-Absorption Modulator, Remote Modulation, WDM-PON, Colorless Optical Access Networks

## 1. INTRODUCTION

With the increase of broadband services including high-speed Internet, data transfer, video-on-demand and other bandwidth-consuming services, the demand for high bit-rate access networks is rising rapidly. To respond to such a bandwidth demand, Fiber-To-The-Home (FTTH) technologies based on different passive optical network (PON) architectures have been developed. Among them, the wavelength division multiplexed PON (WDM-PON), in which each wavelength is dedicated to a single subscriber, appears as the ultimate solution in terms of its very large capacity [1]. In order to enable flexibility and simplicity of such network, it is essential to develop wavelength-independent upstream transmitters, called colorless transmitters. For this purpose, colorless components are studied and developed for subscriber-side transmitter of WDM-based optical access networks.

To meet the "long-term" bandwidth requirement of access networks, 10 Gbps-capable colorless components are under focus. Some low-cost colorless solutions including spectrum-sliced of superluminescent-light-emitting diodes (SLEDs), amplified spontaneous emission (ASE) or supercontinuum source could be considered [2]. However, spectrum-slicing of SLEDs suffers from low power budget and spectrum slicing of ASE suffers from strong intensity noise, prohibitive at 10 Gbps. Wavelength-seeded reflective semiconductor optical amplifiers (RSOAs) could avoid the inconvenient of power budget and intensity noise, but it is limited by its low bandwidth [3]. By taking into account the bandwidth scalability, it seems interesting to develop two attractive solutions:

- a new generation of Fabry-Perot laser diode, which could be widely injection-locked, and directly modulated at 10 Gbps
- a new 10 Gbps monolithically integrated Amplified Reflective Electro-Absorption Modulator (R-EAM-SOA), which separates the modulation and amplification function.

After a brief introduction in section 2 to WDM-PON system, we present in section 3 the IL-FP and their main characteristics. The static properties and performances in a 10 Gbps transmission system will be presented in section 4 for the REAM-SOA.

## 2. WDM-PON SYSTEM ARCHITECTURE

In this paragraph, we present the basic principle of the WDM-PON system architecture, in which the colorless components are used as upstream transmitters. The network architecture is shown in figure 1.

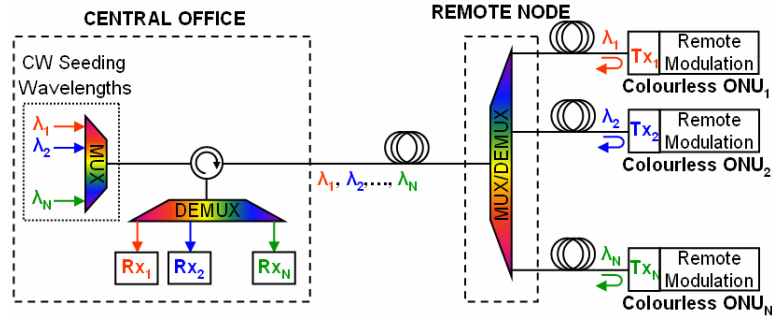

**Figure 1:** WDM-PON architecture for upstream transmission using colorless components

The WDM-PON is essentially based on a point-to-multipoint architecture. In order to distribute broadband services to the subscribers, the Central Office (CO) of the network operator is connected to the terminals located at subscriber's premises called Optical Network Units (ONU). The point-to-multipoint architecture is realized thanks to an intermediate point in the network called Remote Note (RN). It consists in a MUX/DEMUX, which separates and/or recombines each channel of different subscribers.

In the WDM-PON configuration, colorless components are identical and wavelength-independent at ONUs. They are used as the upstream transmitters as shown in Figure 1. The emitted wavelength of each component depends on the wavelength of the seeded signal coming from the CO. The upstream optical signals are modulated with the subscriber's data thanks to the modulation ability of the colorless components.

## 3. INJECTION-LOCKED FABRY-PEROT

Significant performance improvement by using injection-locking and laser processing simplicity are some advantages of IL-FP as colorless transmitter solution. The Fabry-Perot laser is a multi-mode laser, which can operate in a single-mode regime with wavelength-locking mechanism due to optical injection imposed.

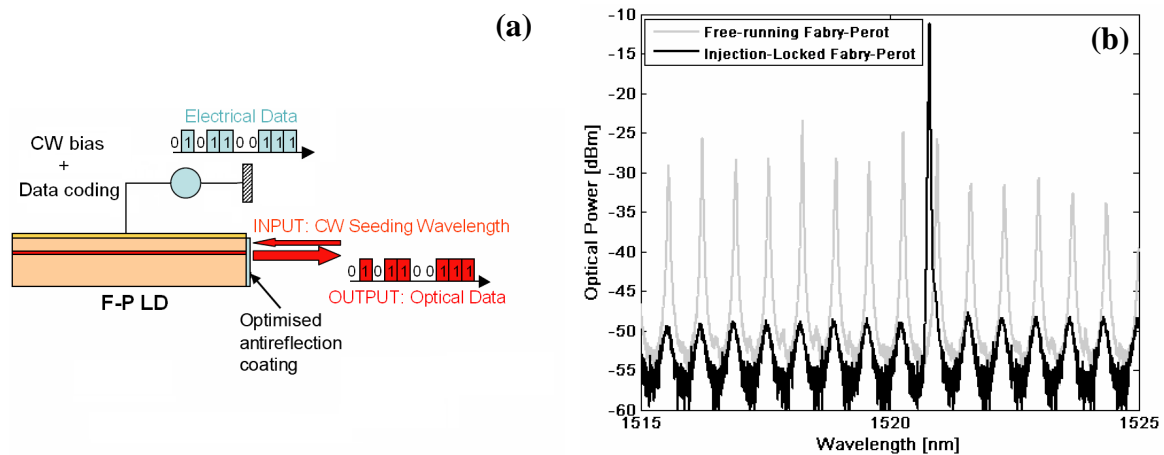

**Figure 2:** Injection-Locked Fabry Perot operation principle (a) and examples of laser spectrum (b)

The operation principle of IL-FP is sketched in figure 2a. An external continuous signal is injected into the Fabry-Perot cavity. The laser will then be “locked” at the injected wavelength. Thus, the IL-FP re-emits at the same wavelength than the injected one. Thanks to the ability of the laser gain section to be directly modulated, the output optical signal is coded, carrying upstream data. An optimized antireflection coating is implemented on the front facet to enhance the input power sensitivity.

The figure 2b presents an example of IL-FP spectrum compared to free-running FP spectrum. The injected power level is around -10 dBm in this case. Strongly single-mode operation with a side-mode-suppression-ratio (SMSR) around 40 dB can be achieved. The following paragraphs describe some performance enhancements of the IL-FP.

### 3.1 Relative intensity noise and modulation properties

The relative intensity noise (RIN) is an important parameter for semiconductor lasers in optical communications. The bulk Fabry-Perot laser usually presents a high intensity noise. In our experiment, the free-running Fabry-Perot laser has at 50 mA a RIN level higher than -130 dBc/Hz below 10 GHz. But with injection-locking by an external low-noise source, which has a RIN lower than -150 dBc/Hz, the RIN of the injected IL-FP is significantly reduced. It does not exceed -140 dBc/Hz, as shown in figure 3a, which corresponds to more than 10 dB of noise reduction. We also observe that the resonance frequency is strongly increased by the injection-locking. The higher the injected power is, the stronger noise-reduction is as well as the higher the resonance frequency is [10]. A resonance frequency higher than 20 GHz can be observed.

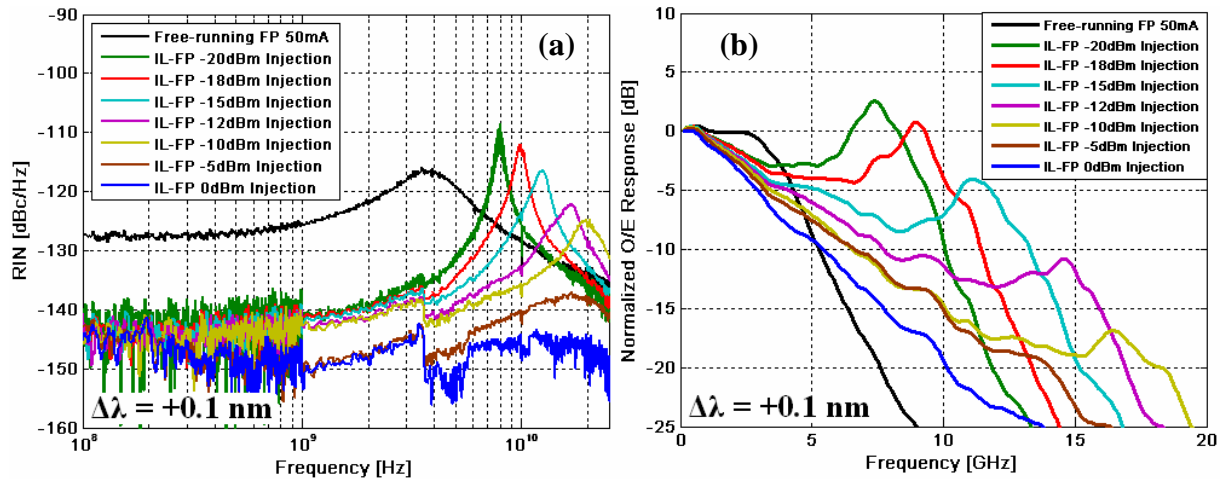

**Figure 3:** Intensity noise (RIN) characteristics (a) and normalized O/E frequency response (b)

We observe the same resonance frequency in the electro-optical frequency response of IL-FP as presented in figure 3b. However, the 3dB-bandwidth is not really improved by injection-locking. On the contrary, it is strongly reduced for higher injected power. Similar results have been theoretically and experimentally obtained with VCSEL [10]. This may be due to an operation close to threshold (50 mA compared to 35 mA threshold), which is necessary in order to obtain an efficient locking regime over a broadband.

### 3.2 Linewidth enhancement factor

The linewidth enhancement factor  $\alpha_H$  (also called alpha parameter or chirp parameter) characterizes the interdependence between amplitude modulation (AM) and frequency modulation (FM) under direct current modulation of semiconductor devices. It is mainly due to the asymmetry of the gain curve, which causes, through Kramers-Kronig relation, a non-zero dispersion at the frequency of maximum gain. It follows that an intensity modulation leads simultaneously to phase or frequency modulation. It is considered as one of the most limiting factors in performance of semiconductor laser in optical communication systems. To measure this factor, we use the method described in [10], which

is based on the measurement of FM index over AM index ratio. In the free-running operation of the FP laser, the measurements cannot have been performed because the linewidth of a mode is out of the range of our equipments (12.5 GHz-linewidth compared to 10 GHz-FSR of Fabry-Perot analyzer)

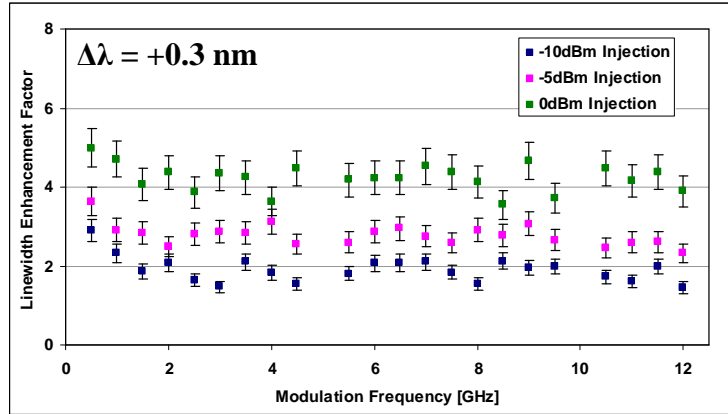

Figure 4: Linewidth enhancement factor vs modulation frequency

In case of injection-locking, we obtain relatively low values of  $\alpha_H$ . For -10 dBm of injected power, a linewidth enhancement factor around 1.9 could be achieved. When injected power increases, the locking mechanism is stronger but  $\alpha_H$  also increases. This fact is also experimentally observed in case of injection-locked DBR [6]. We obtain the linewidth enhancement factor around 2.8 and 4.2 for the injected power at -5 dBm and 0 dBm respectively. A low  $\alpha_H$  value allows a long transmission distance of the modulated signal, thus a long reach of optical access networks.

#### 4. AMPLIFIED REFLECTIVE ELECTRO-ABSORPTION MODULATOR

The Reflective Electro-Absorption Modulator is monolithically integrated with a Semiconductor Optical Amplifier (REAM-SOA). This component benefits from the large bandwidth of the EAM (10 Gbps and beyond) as well as from the power amplification function of the SOA. The operation principle of the colorless transmitter is given in figure 5.

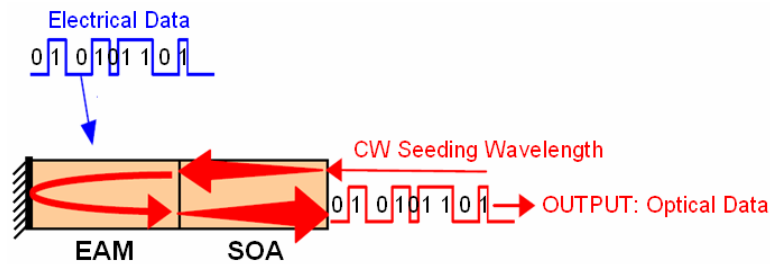

Figure 5: Schematic sketch of an REAM-SOA

Similar to the case of IL-FP in upstream transmission, a continuous signal coming from the CO is optically injected through the front facet of the component, pre-amplified in the SOA and finally modulated by the EAM. The modulated optical signal carrying upstream data is then reflected on the rear facet and boosted out by the SOA. While the input and output signals go through the same front facet, the REAM-SOA is a one-port component, thus it requires simple and cost-effective packaging technology.

##### 4.1 Gain and noise characteristics

In this paragraph, we present some static properties of the component. Since the system budget of access networks is always critical, the optical gain of the component is an important characteristic. Figure 6 presents the reflection gain of the REAM-SOA as a function of wavelength. We observe a positive reflection gain over a spectral range larger than 50 nm in L-band. This demonstrates the

possibility of large spectral range loss-less operations of the colorless component. A spectral range larger than 40nm is obtained with an extinction ratio higher than 20 dB.

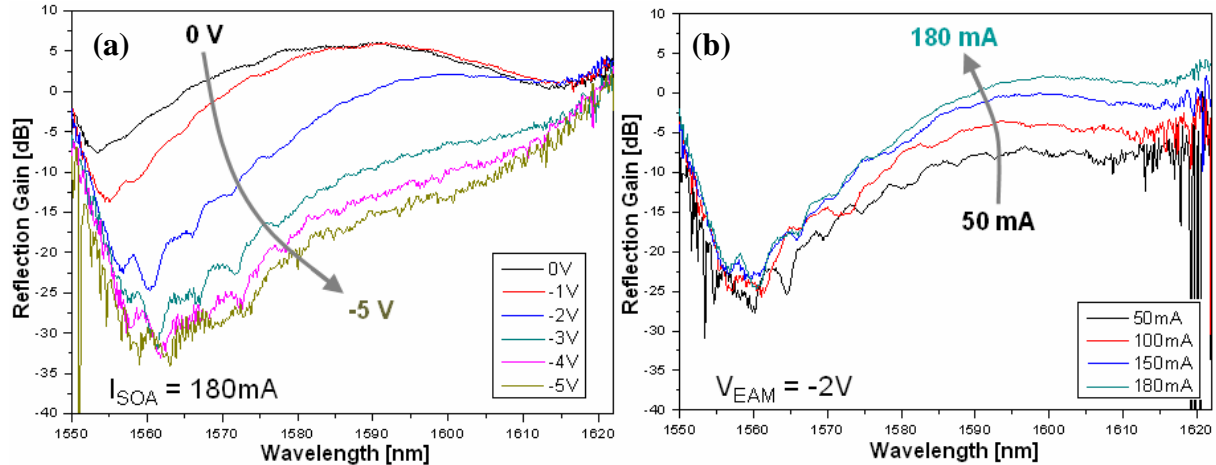

**Figure 6:** Reflection gain of REAM-SOA vs wavelength: For different EAM bias (a) and for different SOA currents (b)

Since the optical power injected into the component is relatively weak (signal coming from the Central Office), the noise level of this input signal is then considerable. Therefore, it is very interesting to examine the noise characteristics of the component. It is characterized by the noise transfer function shown in the figure 7 for different noise-level of the input signal. From measurements, a noise reduction of nearly 10 dB and respectively around 5 dB is obtained for an input power of +3 dBm and respectively -3 dBm.

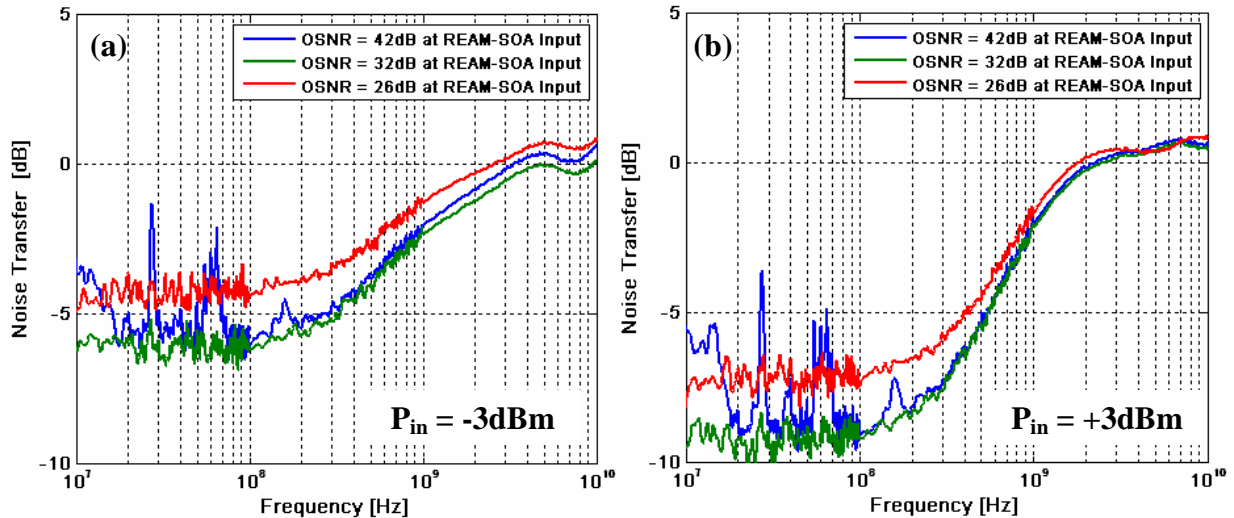

**Figure 7:** Intensity noise transfer function vs. frequency: For -3 dBm optical power input (a) and for +3 dBm optical power input (b)

## 4.2 Transmission experiment

In order to demonstrate the feasibility of the REAM-SOA in a PON system at 10 Gbps, we evaluated the transmission quality of the system using REAM-SOA in a remote modulation configuration [7], i.e. the wavelength source coming from the CO is modulated at the ONU and then re-transmitted upward to the CO. The system configuration is presented in the figure 8a.

This is not really a PON-like system (based on point-to-multipoint architecture), but we could consider it as a wavelength channel in WDM-PON system. The result of bit-error-rate (BER) measurement is presented in the figure 8b. An error-free 10 km transmission has been achieved. For 25 km transmission distance, an error floor at  $5 \cdot 10^{-11}$  is presented. This is due to the interferometric noise

between the useful signal and the Rayleigh backscattering signal at the same wavelength presented in the system.

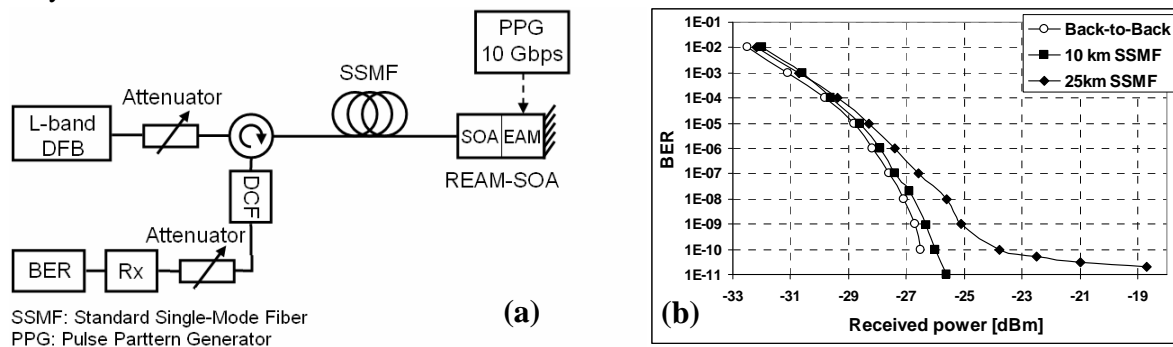

**Figure 8:** Transmission experiment in remote modulation configuration (a) and bit-error-rate measurement (b)

## 5. CONCLUSION

Colorless components based on Injection-Locked Fabry-Perot laser diode and Amplified Reflective Electro-Absorption Modulator have been studied and their main characteristics have been presented. The IL-FP presents low-noise, low-chirp and high-bandwidth capability thanks to injection-locking mechanism. The high-bandwidth, noise-reduction and lossless operation over a large spectral range have been obtained for the REAM-SOA. The feasibility of this component on a 10 Gbps system has also been demonstrated. All these results are very promising for using such simple devices as high speed, low-cost and simple packaging compatible colorless components for next generation optical access networks. Further works will be to improve the component performances such as fully-colorless C-band operation, polarization independence and high sensitivity vs injected power, in order to enable a real deployment in WDM-PON access systems.

## ACKNOWLEDGEMENT

This work has been done in the framework of the French national project ANR ANTARES.

## REFERENCES

- [1] Grobe, K. & Elbers, J., "PON Evolution from TDMA to WDM-PON", OFC NFOEC, Optical Society of America, 2008, NThD6
- [2] Lee, J. et al., "WDM-Based Passive Optical Network Upstream Transmission at 1.25 Gb/s Using Fabry-Perot Laser Diodes Injected With Spectrum-Sliced, Depolarized, Continuous-Wave Supercontinuum Source", Photonics Technology Letters, IEEE, 2006, 18, 2108-2110
- [3] Chanclou, P. et al., "Demonstration of RSOA-Based Remote Modulation at 2.5 and 5 Gbit/s for WDM PON", OFC NFOEC, Optical Society of America, 2007, OWD1
- [4] Kazmierski, C. et al., "Advanced component technologies for colourless access networks", SPIE APOC, 2007
- [5] Payoux, F. et al., "WDM-PON with Colorless ONUs", OFC NFOEC, Optical Society of America, 2007, OTuG5
- [6] Garreau, A. et al., "10Gbit/s Amplified Reflective Electro-absorption Modulator for Colorless Access Networks", IPRM, 2006, 168-170
- [7] G. Girault et al., "10 Gbit/s PON demonstration using a REAM-SOA in a bidirectional fiber configuration up to 25 km SMF", ECOC, 2008, P.6.08
- [8] Shen, A. et al., "Injection Locked DBR Laser Diode module for Access Applications", ECOC, 2007
- [9] Xu, Z. et al., "10 Gb/s WDM-PON Upstream Transmission Using Injection-Locked Fabry-Perot Laser Diodes", OFC NFOEC, Optical Society of America, 2006, JThB72
- [10] Wu, M. et al., "High-Speed Modulation of Optical Injection-Locked Semiconductor Lasers", OFC NFOEC, Optical Society of America, 2008, OThK3
- [11] C. Harder et al., "Measurement of the linewidth enhancement factor alpha of semiconductor lasers", Appl. Phys. Lett., Vol. 42, No. 4, 1983