



HAL
open science

Piezo-ElectroMechanical (PEM) Kirchhoff–Love plates

Silvio Alessandroni, Ugo Andreaus, Francesco Dell’Isola, Maurizio Porfiri

► **To cite this version:**

Silvio Alessandroni, Ugo Andreaus, Francesco Dell’Isola, Maurizio Porfiri. Piezo-ElectroMechanical (PEM) Kirchhoff–Love plates. *European Journal of Mechanics - A/Solids*, 2004, pp.14. hal-00496930v1

HAL Id: hal-00496930

<https://hal.science/hal-00496930v1>

Submitted on 1 Jul 2010 (v1), last revised 23 Jul 2010 (v2)

HAL is a multi-disciplinary open access archive for the deposit and dissemination of scientific research documents, whether they are published or not. The documents may come from teaching and research institutions in France or abroad, or from public or private research centers.

L’archive ouverte pluridisciplinaire **HAL**, est destinée au dépôt et à la diffusion de documents scientifiques de niveau recherche, publiés ou non, émanant des établissements d’enseignement et de recherche français ou étrangers, des laboratoires publics ou privés.

Piezo-ElectroMechanical (PEM) Kirchhoff–Love plates

Silvio Alessandroni^a, Ugo Andreaus^a, Francesco dell’Isola^{a,*}, Maurizio Porfir^{a,b}

^a *Dipartimento di Ingegneria Strutturale e Geotecnica, Università di Roma ‘La Sapienza’, 00184 Roma, Italy*

^b *Engineering Science and Mechanics Department, Virginia Tech., Blacksburg, VA 24060, USA*

Abstract

Recently, the concept of Piezo-ElectroMechanical (PEM) structural members has been developed by Alessandroni et al. (Int. J. Solids Structures 39 (20) (2002) 5279) and Andreaus et al. (J. Vib. Control (2004) in press). Given a structural member, a set of piezoelectric transducers is uniformly distributed on it and electrically interconnected by a circuit that is the electric analog of the host member. In this way a high-performances piezoelectric structural-modification is obtained, that aims to control multimodal mechanical vibrations (see, e.g., Vidoli and dell’Isola (Acta Mech. 141 (2000) 37)). In the present paper the problem of synthesizing an electrically dissipative PEM Kirchhoff–Love (K–L) plate by using completely passive electric elements is addressed. This is done by using a discrete form of the Lagrange functional governing the motion of a K–L plate by a finite difference method. Hence a novel electric circuit governed by the obtained finite dimensional Lagrangian is determined. Multimodal vibration damping is achieved by completing this new circuit with optimally dimensioned and positioned resistors. A realistic simply-supported PEM K–L plate has been designed and its performances in the case of free and forced vibrations have been studied to show its technical feasibility.

Keywords: Vibration control; Piezoelectric transducers; Distributed control; Passive networks

1. Introduction

In Hoffmann and Botkin (1999, 2000), Canon Lenczner (1999), and Kader et al. (2001) the performances of arrays of piezoelectric transducers distributed on structural members and interconnected to active electronic controllers are studied. The performances of a single actuator properly positioned on a structural member and interconnected to a passive resonant circuit is studied by Hollkamp (1994) and by Hagood and Flotow (1991). However, none of these papers addresses the problem of determining optimal passive circuits to which an array of distributed piezoelectric transducers is connected.

In Maurini et al. (2004) and Alessandroni et al. (2002), the concept of distributed piezoelectric passive control of structural vibrations has been developed: the main feature of this novel treatment consists in the synthesis of analog circuits and their use in electrically interconnecting distributed arrays of piezoelectric transducers.

The mathematical results shown by Vidoli and dell’Isola (2000) indicate that the mechanical vibrations can be coupled to the electric oscillations for obtaining a beating/amplitude modulation phenomenon by interconnecting the transducers with an analog electric circuit, i.e. by a circuit governed by exactly the same PDE as the structural member. Therefore, an optimal damping of mechanical vibrations using electric dissipation is expected when suitably inserting, in the found analog circuit, some resistive elements.

In the present paper we address the following (interrelated) problems:

1. synthesize an analog circuit of a Kirchhoff–Love (K–L) plate consisting of completely passive elements.¹ The K–L plate assumption states that the fibers remain perpendicular to the mid-surface of the plate and maintain their length;
2. model a Piezo–ElectroMechanical (PEM) plate;
3. establish how to add suitable resistive elements in the previously found analog circuit in order to obtain a multimodal (i.e., mode-independent) damping of mechanical vibrations. The structural members thus obtained will be called electrically-dissipative PEM plates;
4. design a realistic PEM plate (i.e., a structural member that could be used in engineering applications) and study its performances under external disturbances.

We will conclude by comparing the damping performances of a distributed Bed Of mechanical Dampers (BOD) connected to a K–L plate with those of the PEM plate.

The novel circuits which we synthesize are passive, easily realizable, and easily adaptable in the design of realistic engineering devices.

2. PEM K–L Plates

2.1. Analog circuit

In order to find an electric circuit analog of the K–L plate, we start by considering a plate, the vibration of which is governed (see, e.g., Forray, 1968) by the Lagrange functional, where the deformation energy U^m and the kinetic energy T^m are given by²

$$U^m = \frac{S}{2} \int_{\Omega} [(u_{xx}^2 + u_{yy}^2 + 2v u_{xx} u_{yy}) + 2(1 - v) u_{xy}^2],$$

$$T^m = \frac{\rho h}{2} \int_{\Omega} \left(\frac{du}{dt} \right)^2.$$

The action time-density for the K–L plate (when ignoring dissipative phenomena) is therefore given by the Lagrangian $\mathcal{L}^m = T^m - U^m$. The K–L plate is an infinite dimensional mathematical model. In order to synthesize a circuit analog to K–L plate, we introduce a finite set of Lagrange parameters describing – in an approximate way – the state of the K–L plate, i.e., the set of displacements sampled at the nodes of a fixed uniform grid in the plate reference configuration. Let us label the generic point of the grid by the subscripts $(\cdot)_{i,j}$ so that the value at this point of the generic field f will be denoted by $f_{i,j}$. The step of the grid (assumed to be equal along both the x and y directions) will be denoted by ε . Consistently, the spatial derivatives $\frac{\partial}{\partial x}$ and $\frac{\partial}{\partial y}$ will be approximated by the forward finite differences operators $(\tilde{\Delta}_x/\varepsilon)_{i,j}$ and $(\tilde{\Delta}_y/\varepsilon)_{i,j}$, where $(\tilde{\Delta}f)_k = f_{k+1} - f_k$ stands for the simple forward difference operator. The introduction of the dimensionless deflection $\tilde{u} = u/u_o$ and the time derivative operator $d(\cdot)/d\tilde{t} = t_o d(\cdot)/dt =: (\dot{\cdot})$, where the characteristic deflection u_o and time t_o are used, allows for writing the approximate (discrete) strain energy U_d^m and kinetic energy T_d^m of the K–L plate in the following form:

$$U_d^m = \frac{S}{2} \left(\frac{u_o}{\varepsilon} \right)^2 \sum_i \sum_j [(\tilde{\Delta}_{xx} \tilde{u})_{i,j}^2 + (\tilde{\Delta}_{yy} \tilde{u})_{i,j}^2 + 2v (\tilde{\Delta}_{xx} \tilde{u})_{i,j} (\tilde{\Delta}_{yy} \tilde{u})_{i,j} + 2(1 - v) (\tilde{\Delta}_{xy} \tilde{u})_{i,j}^2],$$

$$T_d^m = \frac{\rho h}{2} \left(\frac{u_o \varepsilon}{t_o} \right)^2 \sum_i \sum_j (\dot{\tilde{u}})_{i,j}^2. \quad (1)$$

As the derivatives become better approximated by finite differences, the discrete Lagrangian system gets closer to the K–L plate model. The actions considered in both models are likely to be sufficiently close when suitable regularity conditions on

¹ In Alessandrini et al. (2002) the synthesized analog circuit could not dispense with external feeding.

² The meanings of the introduced symbols are: K–L plate bending stiffness: $S = h^3 E / 12(1 - \nu^2)$; thickness: h ; Young's Modulus: E ; Poisson ratio: ν ; plate domain: Ω ; vertical deflection: u ; volumetric mass density ρ ; time variable: t . Moreover, we have introduced a Cartesian system of coordinates (x, y) on the plate's reference configuration Ω , and have denoted by $(\cdot)_{,x}$ and $(\cdot)_{,y}$ the derivatives with respect to x and y variables, respectively.

displacement fields are assumed. We leave a precise statement of such regularity conditions and error estimates to a more accurate mathematical treatment.

Given a quadratic finite dimensional Lagrangian, say $\mathcal{L}_d^m := T_d^m - U_d^m$, it is well known (see, e.g., Crandall et al., 1968) that it is possible to synthesize a lumped circuit governed by the same evolution (Euler–Lagrange) equations. The resulting analog circuit, is in general not topologically connected and may have more nodes than the grid. The synthesis can be done, once the Lagrange parameters are recognized as the analogs of the flux-linkages³ of suitable nodes in the electric circuit, by identifying the strain mechanical energy with the magnetic energy (associated with inductors) and the kinetic energy with the electric energy (associated with capacitors). Indeed to each node of the sampling grid previously introduced we will associate a node (denoted by $n_{i,j}$ and called principal) of the analog circuit.⁴ The flux-linkage $\psi_{i,j}$ will correspond to the deflection $u_{i,j}$. Hence, connecting every node to ground by means of a capacitor, a subcircuit of the analog circuit in which the capacitive electric energy T^e is paralleling the mechanical kinetic energy T_d^m is determined. Consequently, the elastic energy U_d^m of the plate may be paralleled by the magnetic energy U^e stored in the remaining part of the analog circuit constituted by a set of inductors opportunely connected to the capacitors by means of an appropriate network of electric transformers. The transformers do not store energy: they simply relate the voltages of nonprincipal nodes to those of $n_{i,j}$. Introducing transformers allows to have the second order differences of the displacement fields appearing in (1).

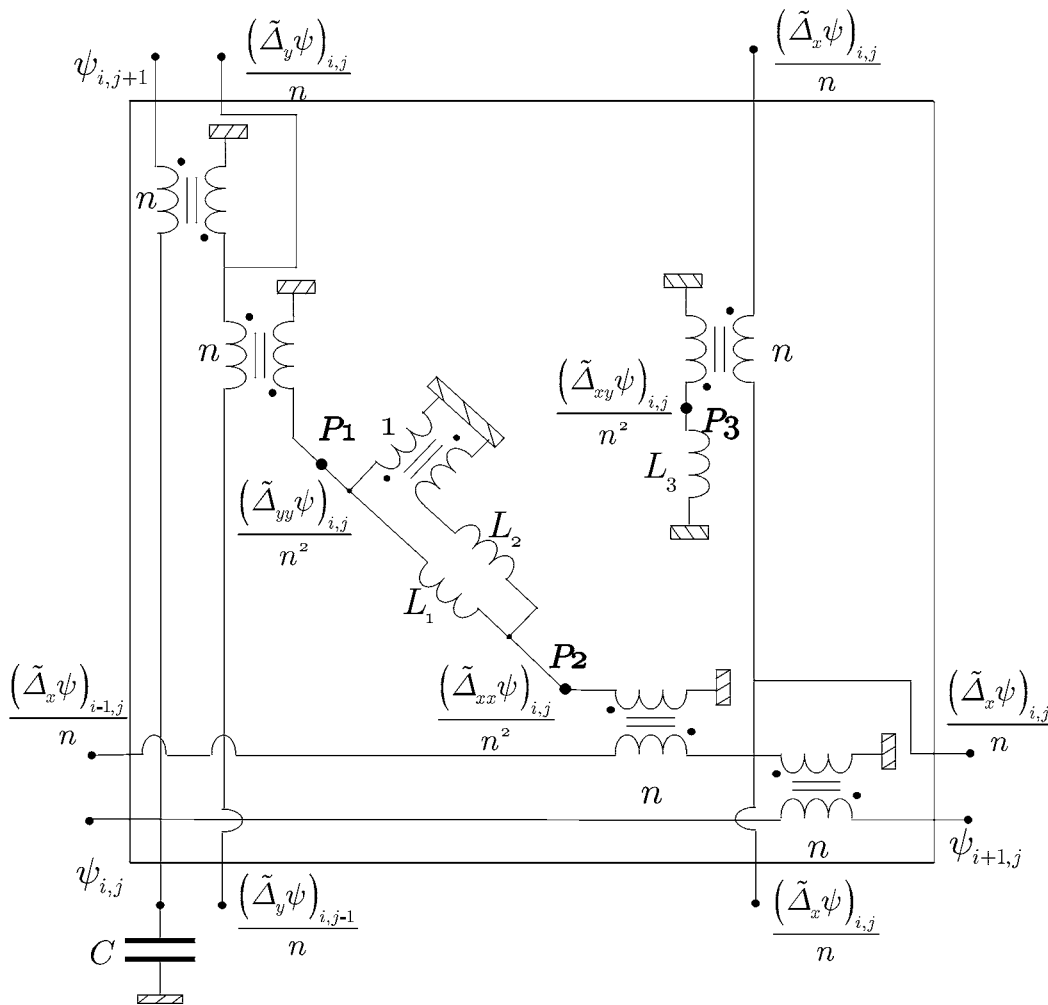

Fig. 1. Nondissipative analog circuitual module.

³ The flux-linkage is defined as the time integral of the voltage drop with respect to a reference ground.

⁴ Other nodes may appear in the analog circuit, which do not correspond with any one of the grid nodes. These nodes are called nonprincipal.

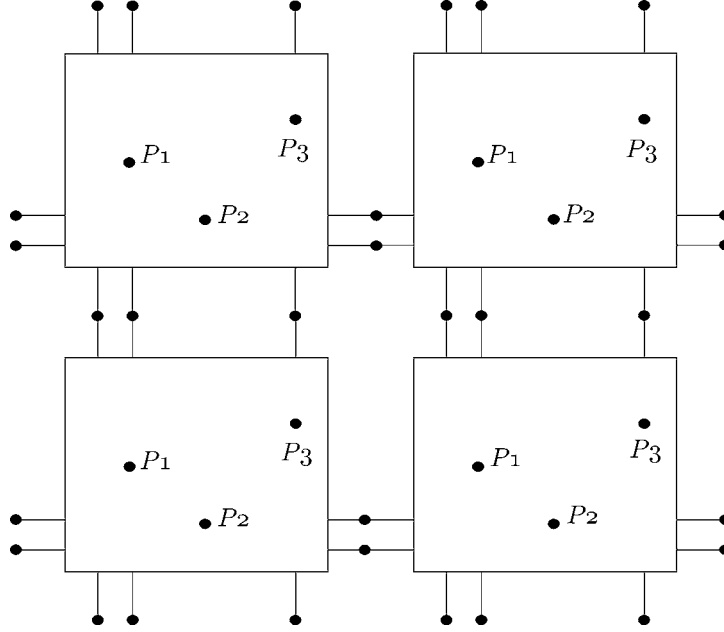

Fig. 2. Connection among modules.

Because of the analogy-choice which has been made, the electric circuit synthesized will be coupled to the plate only in dynamic conditions. It is an open problem to determine a static analog for K–L plate. In Fig. 1 one of the possible topologies for the circuitual module (corresponding to the i, j node) is presented, that is able to realize an electric analog for the K–L plate. In Fig. 2 the connection among different modules is shown. The electromechanical analogy will be fully accomplished once a dimensionless flux-linkage $\tilde{\psi} = \psi/\psi_o$ is introduced, by means of a characteristic flux-linkage ψ_o . Consequently, we can express the electric energies U^e, T^e in the following form:

$$\begin{aligned}
 U^e &= \frac{1}{2n^4} \frac{L_1 + L_2}{L_1 L_2} \psi_o^2 \sum_i \sum_j \left[(\tilde{\Delta}_{xx} \tilde{\psi})_{i,j}^2 + (\tilde{\Delta}_{yy} \tilde{\psi})_{i,j}^2 + 2 \frac{L_1 - L_2}{L_1 + L_2} (\tilde{\Delta}_{xx} \tilde{\psi})_{i,j} (\tilde{\Delta}_{yy} \tilde{\psi})_{i,j} \right. \\
 &\quad \left. + \frac{L_2 L_1}{L_3 (L_1 + L_2)} (\tilde{\Delta}_{xy} \tilde{\psi})_{i,j}^2 \right], \\
 T^e &= \frac{C \psi_o^2}{2t_o^2} \sum_i \sum_j (\dot{\tilde{\psi}})_{i,j}^2.
 \end{aligned} \tag{2}$$

The electric analog circuit that has been found allows for quantitative analogies with the K–L plate once the coefficients of the electric energies (see Eqs. (2)) are assumed to be equal to the coefficients of the mechanical ones (see Eqs. (1)). Simple algebra allows us to get the following equalities in which the electric impedances needed in the analog circuit are explicitly given in terms of mechanical parameters and transformers turns-ratios:

$$\frac{L_1}{L_2} = \frac{(1 + \nu)}{(1 - \nu)}, \quad \frac{L_1}{L_3} = 4, \quad n^4 L_1 C = \frac{2\rho h}{S(1 - \nu)} \varepsilon^4. \tag{3}$$

It is evident from Eqs. (3) that the choice of the circuitual parameters L_1, L_2, L_3, n and C is not unique. Indeed, the introduction of transformers in the circuitual analogs not only allows for the synthesis of completely passive networks (which has not been possible in Alessandrini et al., 2002), but also permits a more ductile variation of the inductance values.

2.2. Piezoelectric transducer modelling

Some circuitual elements in the analog (lumped) circuit that has been synthesized in the previous subsection are capacitors. They connect each principle node $n_{i,j}$ to ground.

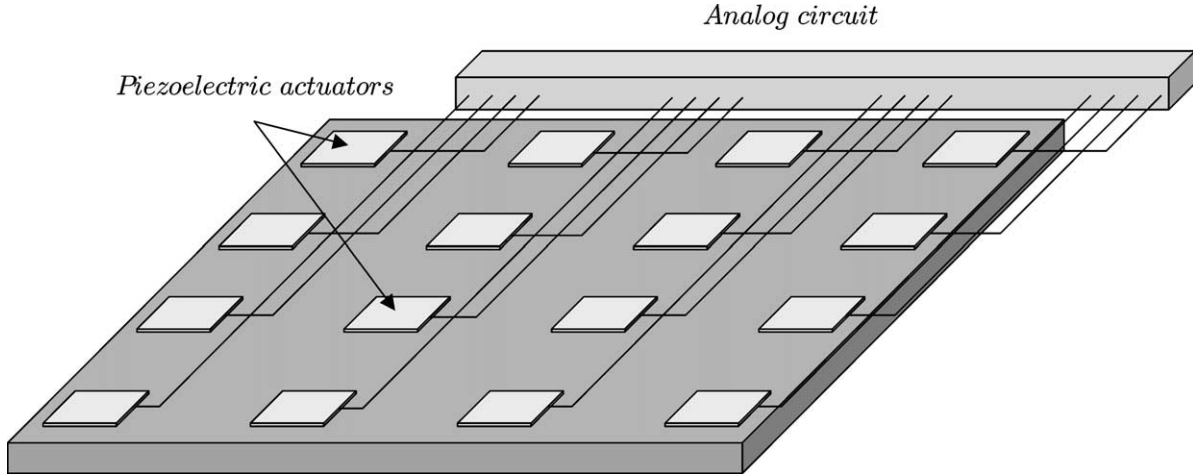

Fig. 3. PEM Plate.

By making use of the analog circuit, the PEM plate is easily conceived by connecting the previously described inductive subcircuit in the electric analog network to the electric terminals of an array of bending⁵ piezoelectric transducers uniformly distributed upon the plate surfaces (see Fig. 3). Indeed, the electric Norton equivalent for any of such transducers is given by a grounded capacitor in parallel connection with a current generator. In Vidoli and dell'Isola (2001) it is explained why analog networks must be employed in order to optimally control mechanical vibrations of a structural member using an array of piezoelectric transducers. We limit ourselves here to stating that an analog circuit is able to resonate at every eigenfrequency of the given structural member and show exactly the same spatial modal shapes. Therefore, it is able to optimize the efficiency of the chosen energy transduction.

In the present subsection we will provide the governing Lagrangian of the system constituted by the piezoelectric arrays and the host plate. Later, we will combine this Lagrangian with that one governing the electric circuit (see Eqs. (2)) in order to model the overall electromechanical behavior of the considered PEM plate. Let us consider the general three-dimensional constitutive relations for a transversely-isotropic material (see, e.g., Maugin, 1980) with the poling direction along the z axis that, in the case of plane stress (along xy directions) and electric field nonzero only in the direction z of transverse isotropy, reduce to

$$\begin{bmatrix} \boldsymbol{\sigma} \\ D_z \end{bmatrix} = \begin{bmatrix} \mathbf{K}_{mm} & -\mathbf{K}_{me} \\ \mathbf{K}_{me}^T & K_{ee} \end{bmatrix} \begin{bmatrix} \mathbf{e} \\ E_z \end{bmatrix}, \quad (4)$$

where $\boldsymbol{\sigma}^T = [\sigma_x \ \sigma_y \ \sigma_{xy}]$ indicates the nonzero components of the stress tensor; $\mathbf{e}^T = [e_x \ e_y \ \gamma_{xy}]$ the nonzero engineering strains; and D_z and E_z the nonzero components of the electric displacement and electric field, respectively. The electromechanical stiffness matrix appearing in (4) are given by:

$$\mathbf{K}_{mm} = \begin{bmatrix} k_{mm} & \nu_p k_{mm} & 0 \\ \nu_p k_{mm} & k_{mm} & 0 \\ 0 & 0 & \frac{k_{mm}}{2}(1 - \nu_p) \end{bmatrix}, \quad \mathbf{K}_{me} = k_{me} \begin{bmatrix} 1 \\ 1 \\ 0 \end{bmatrix}, \quad K_{ee} = \left(\varepsilon_T - \frac{2d_{31}^2 E_p}{1 - \nu_p} \right),$$

$$k_{mm} = \frac{E_p}{1 - \nu_p^2}, \quad k_{me} = \frac{d_{31} E_p}{1 - \nu_p}.$$

The parameters ν_p and E_p , denote the Poisson coefficient and the elastic modulus of the considered piezoelectric material measured when $E_z = 0$, while d_{31} and ε_T represent the transverse piezoelectric coupling coefficient and the dielectric constant measured when the mechanical stresses vanish (see, e.g., IEEE, 1987). The dimensions of each piezoelectric patch are $l_p \times l_p \times \delta$, with δ being the distance between the electrodes. The geometric center of each transducer is coincident with

⁵ By a bending piezoelectric transducer we mean a pair of piezoelectric elements symmetrically positioned on the plate surfaces, in parallel connection with a common terminal to ground, both polarized in the transverse direction.

the i, j node. We regard the electric field as independent of the z coordinate.⁶ Hence, denoting with $V_{i,j}$ ($\psi_{i,j}$) the voltage at the i, j piezoelectric transducer, the following relation between the electric field and the voltage holds:

$$E_z = -\frac{V_{i,j}}{\delta} \text{RECT}_{i,j},$$

where $\text{RECT}_{i,j}$ indicates the characteristic function defined by:

$$\text{RECT}_{i,j} = \begin{cases} 1, & |x - x_i| \leq l_p/2, \text{ and } |y - y_j| \leq l_p/2, \\ 0, & \text{elsewhere.} \end{cases}$$

As a consequence, the capacitance C of each bending piezoelectric transducer, under no-strain conditions, is given by

$$C = 2K_{ee} \frac{l_p^2}{\delta}.$$

By assuming perfect bonding at the plate-transducers' interphase,⁷ it is easy to relate the kinematics of the patch i, j to the kinematics of the host plate:

$$e_x = -\frac{h}{2} u_{xx} \text{RECT}_{i,j}, \quad e_y = -\frac{h}{2} u_{yy} \text{RECT}_{i,j}, \quad \gamma_{xy} = -h u_{xy} \text{RECT}_{i,j}. \quad (5)$$

When dealing with variational formulation for the dynamics of piezoelectric materials, several approaches may be adopted. In what follows, we will choose the displacement and the electric field to be the kinematical descriptors for the considered piezoelectric layer (see, e.g., Fernandes and Pouget, 2002). Therefore, the Lagrangian for the i, j element, say $(\mathcal{L}^P)_{i,j}$, is expressed by:

$$(\mathcal{L}^P)_{i,j} = (T^P)_{i,j} - (H^P)_{i,j},$$

where $(T^P)_{i,j}$ denotes the kinetic energy and $(H^P)_{i,j}$ the enthalpy⁸ (see, e.g., IEEE, 1987).

From the given assumptions on the stress and strain fields, electric field, and electric displacement field, the enthalpy becomes:

$$\begin{aligned} (H^P)_{i,j} &= \iint_{\Omega} \int_{I_z} \text{RECT}_{i,j} \left\{ \frac{1}{2} \mathbf{e}^T \mathbf{K}_{mm} \mathbf{e} - \mathbf{e}^T \mathbf{K}_{me} E_z - \frac{1}{2} K_{ee} E_z^2 \right\} \\ &= \int_{\Omega} \text{RECT}_{i,j} \left\{ \delta \left(\frac{h}{2} \right)^2 k_{mm} [(u_{xx}^2 + u_{yy}^2 + 2\nu_p u_{xx} u_{yy}) + 2(1 - \nu_p) u_{xy}^2] + h k_{me} (u_{xx} + u_{yy}) \psi_{i,j} - \frac{K_{ee}}{\delta} \psi_{i,j}^2 \right\}, \end{aligned}$$

where

$$I_z = \left[-\frac{h}{2} - \delta, -\frac{h}{2} \right] \cup \left[\frac{h}{2}, \frac{h}{2} + \delta \right].$$

On the other hand, the kinetic energy becomes:

$$(T^P)_{i,j} = \delta \int_{\Omega} \text{RECT}_{i,j} \rho_p \dot{u}^2,$$

where ρ_p denotes the volumetric density of mass for the piezoelectric material.

In conclusion, the total contributions to the Lagrangian of the system given by the entire array of piezoelectric transducers, after a finite difference approximation similar to that leading to Eq. (1) (in terms of non-dimensional discrete variables $(\tilde{u}_{i,j}, \tilde{\psi}_{i,j})$), become:

⁶ The restrictive assumption of uniform electric field along the z direction, is justified by the small ratio of the piezoelectric thickness to that of the plate. This assumption has been removed in Sze et al. (2004).

⁷ Removing this assumption yields a slightly different estimation of the piezoelectric coupling effectiveness (see, e.g., Crawley and Anderson, 1990).

⁸ The stress fields and electric displacement can be derived from the enthalpy:

$$\sigma_x = \frac{\partial (H^P)_{i,j}}{\partial e_x}, \quad \sigma_y = \frac{\partial (H^P)_{i,j}}{\partial e_y}, \quad \sigma_{xy} = 2 \frac{\partial (H^P)_{i,j}}{\partial \gamma_{xy}}, \quad D_z = -\frac{\partial (H^P)_{i,j}}{\partial E_z}.$$

$$\begin{aligned} \mathcal{L}_d^p = & \rho_p \delta \eta^2 \left(\frac{u_o \varepsilon}{t_o} \right)^2 \sum_{ij} \dot{\tilde{u}}_{i,j}^2 - \delta \left(\frac{h}{2} \right)^2 k_{mm} \eta^2 \left(\frac{u_o}{\varepsilon} \right)^2 \sum_{ij} [(\tilde{\Delta}_{xx} \tilde{u})_{i,j}^2 + (\tilde{\Delta}_{yy} \tilde{u})_{i,j}^2 + 2\nu_p (\tilde{\Delta}_{xx} \tilde{u})_{i,j} (\tilde{\Delta}_{yy} \tilde{u})_{i,j} \\ & + 2(1 - \nu_p) (\tilde{\Delta}_{xy} \tilde{u})_{i,j}^2] + h k_{me} \frac{\eta^2 u_o \psi_o}{t_o} \sum_{ij} \dot{\tilde{\psi}}_{i,j} [(\tilde{\Delta}_{xx} \tilde{u})_{i,j} + (\tilde{\Delta}_{yy} \tilde{u})_{i,j}] - \frac{1}{2} C \left(\frac{\psi_o}{t_o} \right)^2 \sum_{ij} \dot{\tilde{\psi}}_{i,j}^2, \end{aligned} \quad (6)$$

where η^2 is the ratio between the area covered by the array of piezoelectric transducers and that of the plate surface, that is $\eta^2 = l_p^2 / \varepsilon^2$.

In order to be tuned with the mechanical vibrations, the analog circuit (where the set of capacitors has been substituted by the piezoelectric inherent capacitances) has to be designed to take into account the additional stiffness and mass due to the presence of the piezo-array.

2.3. PEM model

In conclusion, the approximate finite dimensional model of the PEM K–L plate is a Lagrangian system, whose Lagrangian parameters are the nodal displacements $\tilde{u}_{i,j}$ and the nodal flux-linkages $\tilde{\psi}_{i,j}$. The overall Lagrangian can be expressed using Eqs. (1), (2) and (6) by:

$$\mathcal{L}_d = \mathcal{L}_d^p + \mathcal{L}_d^m - U^e; \quad (7)$$

since the electric energy contribution T^e is already included in \mathcal{L}_d^p .

From (7), it is easy to derive a set of discrete Euler–Lagrange equations for the PEM plate. The resulting system of ODEs can have a huge number of unknown time functions. In order to get a qualitative insight into its solution, in some circumstances of interest in engineering applications, one can focus on the limit of (7) as the number of transducers goes to infinity. Such a formal procedure may have direct applicative interests in controlling low mechanical modes, i.e. modes the wavelengths of which are greater than the size of the transducer. We believe that the rigorous mathematical proof given for a similar problem by Hoffmann and Botkin (1999), may be adapted to the case at hand. However, the homogenized model may also be of use in a preliminary dimensioning.

The idea of using a homogenized model instead of a discrete one is often used both in mechanics and circuits theory (see, e.g., Maurini et al., 2004). A truss modular structure and a lumped realization of a telegraphist transmission line, naturally described by finite dimensional Lagrangian systems, are sometimes studied using PDEs, which are obtained by a suitable homogenization procedure. From the analysis of (7), it is reasonable to assume that the homogenized model of the system is represented by the following system of PDEs, when the characteristic displacement and flux linkage are chosen to assure gyroscopic coupling⁹ and the electric system is tuned to the vibrating plate:

$$\begin{cases} \tilde{\nabla}^4 \tilde{u} + \alpha^4 \ddot{\tilde{u}} - \beta^2 \tilde{\nabla}^2 \dot{\tilde{\psi}} = 0, \\ \tilde{\nabla}^4 \tilde{\psi} + \alpha^4 \ddot{\tilde{\psi}} + \beta^2 \tilde{\nabla}^2 \dot{\tilde{u}} = 0, \end{cases} \quad (8)$$

where the operator $\tilde{\nabla}$ represents the gradient in the previously introduced dimensionless space variables. The new parameters in (8) are defined by¹⁰

$$\begin{aligned} \alpha^4 &= \frac{\rho_t l_o^4}{S_t t_o^2}, \\ \beta^2 &= -\eta^2 h k_{me} \frac{1}{S_t} \sqrt{\frac{\rho_t}{C/\varepsilon^2}} \frac{l_o^2}{t_o}, \end{aligned}$$

where ρ_t denotes the homogenized mass per unit surface and S_t the overall bending stiffness, i.e.:

$$\rho_t = \rho h \left(1 + 2\eta^2 \frac{\rho_p \delta}{\rho h} \right), \quad S_t = S + \frac{\delta h^2}{2} \eta^2 k_{mm}.$$

Once a multiresonance electromechanical coupling has been assured, it is desirable to complete the electric circuit via a dissipative network to efficiently dissipate the energy content of every oscillation eigenmode. Taking into account the results

⁹ The characteristic flux linkage ψ_o and displacement u_o satisfy: $\psi_o / u_o = \sqrt{\rho_t / (C/\varepsilon^2)}$.

¹⁰ When the assumptions of perfect bonding and constant electric field are removed, different estimation of the governing parameters α and β are achieved. Nevertheless the validity of the proposed methodology remains still unaffected, provided that the inductances are tuned with the new values of the elastic stiffness, mass density and piezoelectric capacitance.

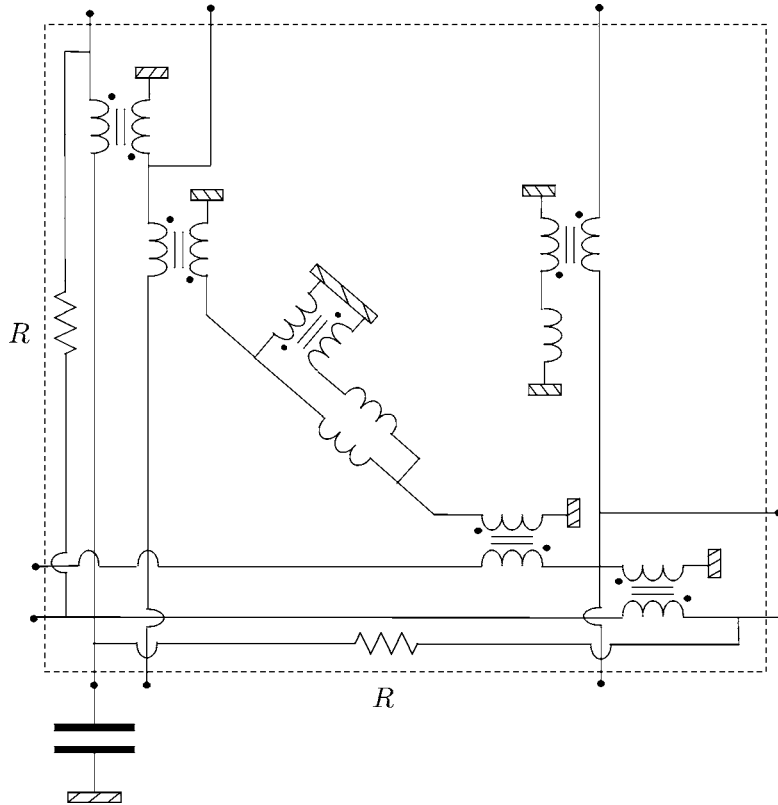

Fig. 4. Dissipative analog module.

found in Andreaus et al. (2004), we insert resistors in the inductive subcircuit of the analog circuit to obtain the Laplacian as the differential dissipative operator. Using a synthesis procedure similar to the one adopted to obtain the analog nondissipative circuit, we get the circuit sketched in Fig. 4, where resistors are placed among every i, j node and all its adjacent ones. Therefore, the governing equations of the dissipative system become:¹¹

$$\begin{cases} \tilde{\nabla}^4 \tilde{u} + \alpha^4 \ddot{\tilde{u}} - \beta^2 \tilde{\nabla}^2 \dot{\tilde{\psi}} = 0, \\ \tilde{\nabla}^4 \tilde{\psi} + \alpha^4 \dot{\tilde{\psi}} + \beta^2 \tilde{\nabla}^2 \dot{\tilde{u}} - \gamma^2 \tilde{\nabla}^2 \dot{\tilde{\psi}} = 0, \end{cases} \quad (9)$$

where the dimensionless dissipative coefficient γ^2 is given by:

$$\gamma^2 = \frac{1}{R} \frac{l_o^2}{t_o} \frac{\rho_t}{C/\epsilon^2} \frac{1}{S_t}.$$

In the language of the theory of control we introduce, via the array of piezoelectric transducers, an electric passive controller of mechanical vibrations: the parameter characterizing such a controller is γ^2 (for more details see Andreaus et al., 2004). In what follows, we will determine the optimal value for γ^2 by applying the so-called pole placement technique. This optimal value will allow for a mode-independent vibration damping.

2.4. Simply supported PEM plate

In the present subsection, the analysis of a vibrating simply supported PEM plate evolution will be developed using the Galerkin method. The electromechanical fields $(\tilde{u}(x, y, t), \tilde{\psi}(x, y, t))$ are expressed by:

¹¹ The considered system of PDEs is linear, and has constant coefficient. The authors think that the analysis of parametric vibrations induced by time variations of electric and piezoelectric properties represents an important research topic, and have in mind to devote further efforts to it in the future.

$$\begin{cases} \tilde{u}(x, y, t) = \sum_k p_k(t) m_k(x, y), \\ \tilde{\psi}(x, y, t) = \sum_k q_k(t) m_k(x, y), \end{cases}$$

where $p_k(t)$ and $q_k(t)$ are the time depending Fourier coefficients of the eigenfunctions $m_k(x, y)$ coming from the eigenvalues problem

$$\tilde{\nabla}^4 m_k = \lambda_k^4 m_k,$$

with simply supported boundary conditions.¹²

Introducing the previous expressions into the (9) and projecting on the given basis, it is easy to derive the ODEs for the electrical and mechanical Fourier coefficients $p_k(t)$, $q_k(t)$

$$\begin{aligned} \lambda_k^4 p_k + \alpha^4 \ddot{p}_k - \beta^2 \sum_h A_{kh} \dot{q}_h &= 0, \\ \lambda_k^4 q_k + \alpha^4 \ddot{q}_k + \beta^2 \sum_h A_{kh} \dot{p}_h - \gamma^2 \sum_h A_{kh} \dot{q}_h &= 0, \end{aligned} \quad (10)$$

where the coupling coefficients A_{kh} is given by¹³

$$A_{kh} = \langle \tilde{\nabla}^2 m_k, m_h \rangle = -\lambda_k^2 \delta_{hk}.$$

Let us remark that the structural internal damping in the host plate material has been omitted for two reasons: (i) the presented treatment is based on a homogenized model of the PEM plate, which gives accurate results provided that the modal wavelengths are sufficiently larger than the grid-step. Therefore, the proposed approach is particularly reliable for lower modes, which are less sensitive to internal damping; (ii) aim of the considered sample problem is to investigate the electric damping capability of the PEM plate at hand. Therefore, taking into account the structural damping could have shadowed the role played by the electric damping itself.

We underline that, in order to keep a complete electromechanical analogy, the boundary conditions for the electric field must be the analog of those characterizing simply supported plates. This implies that the branches of the analog circuit, which are connected to the terminals of the piezoelectric transducers close to the constrained edges of the PEM plate, must be suitably shunted.

In order to show the electromechanical coupling in such a system we consider the free evolution of a simply supported nondissipative PEM plate due to an initial deflection coincident with the k mode shape, i.e., $p_k(t)|_{t=0} = p_o$. Therefore, the unique nonvanishing Fourier coefficients are:

$$\begin{bmatrix} p(t) \\ q(t) \end{bmatrix}_k = \begin{bmatrix} p_o \left(\cos \omega_k^c t \cos \omega_k^m t + \frac{\omega_k^m}{\omega_k^c} \sin \omega_k^c t \sin \omega_k^m t \right) \\ p_o \left(\cos \omega_k^c t \sin \omega_k^m t - \frac{\omega_k^m}{\omega_k^c} \sin \omega_k^c t \cos \omega_k^m t \right) \end{bmatrix},$$

where we defined the carrier and the modulating frequencies ω_k^c and ω_k^m :

$$\omega_k^c = \frac{\lambda_k^2}{\alpha^4} \frac{1}{2} \sqrt{\beta^4 + 4\alpha^4}, \quad \omega_k^m = \frac{1}{2} \lambda_k^2 \frac{\beta^2}{\alpha^4}. \quad (11)$$

Let us note that the ratio of ω_k^c to ω_k^m is mode-independent, confirming the broad-band authority of the proposed controller. Let us remark that the evolution shows a beating/amplitude modulation phenomenon between the electrical and mechanical subsystems. Using the language of the theory of signals we can say that the control network results in an amplitude modulation of the mechanical signals, where the carrier frequency ω_k^c is close (when β is small) to that of the uncontrolled mechanical system, whereas the modulating frequency ω_k^m is proportional to the coupling coefficient β^2 (see Eqs. (11)).

2.5. Optimal condition for the dissipative system

Once the optimal coupling between the mechanical system and its electric analog has been established, an optimal electric dissipation of the mechanical energy has to be obtained. Following Andreaus et al. (2004), a suitable positioning of the resistors in the analog circuit has already been provided in the previous section. In what follows, we will derive an optimal value for the parameter γ . The chosen optimality criterion is based on the maximization of all the modal time rate decays, i.e.:

¹² For simply supported boundary conditions, the vibrations analysis can be performed also with infinite Fourier series, which coincides with the Galerkin approach.

¹³ The brackets $\langle \cdot, \cdot \rangle$ represents the usual scalar product in the L^2 space.

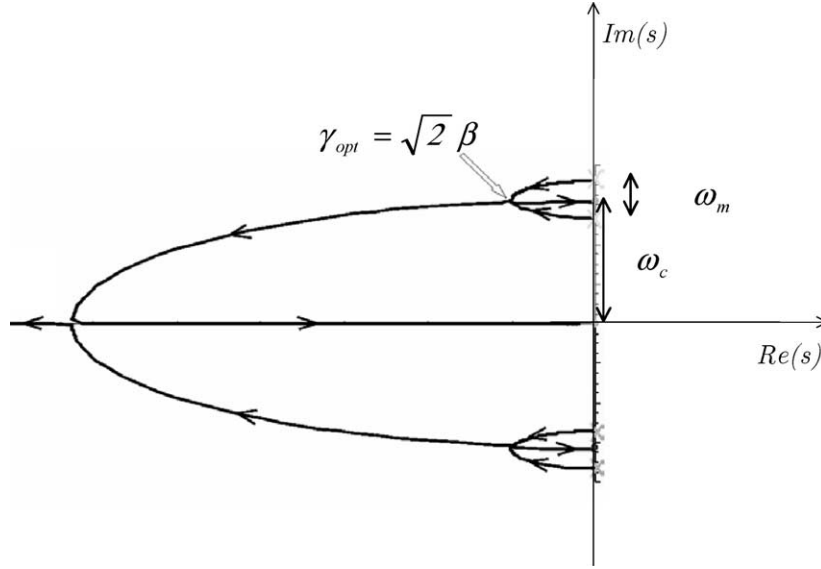

Fig. 5. Root locus of the characteristic polynomial for $\gamma > 0$.

Problem 1. Find γ such that the modal time rate decay

$$\tau_k := \min_{j=1,\dots,4} |\operatorname{Re}[s_k^j]|$$

is minimized for every k , $\{s_k^j\}_{j=1,\dots,4}$ being the four eigenvalues of (10).

As shown in Andreaus et al. (2004), the optimal value γ may be found by imposing that for every mode number k , there exists two distinct complex conjugate eigenvalues with multiplicity equal to two (see Fig. 5). Therefore, the optimization problem is solved by means of the pole placement technique. The poles s_k^j of the electromechanical system can be regarded as the roots of the characteristic polynomial $P_k(s)$:

$$P_k(s) = D_k(s) + \gamma^2 N_k(s),$$

where

$$D_k(s) = s^4 + \frac{\lambda_k^4}{\alpha^8} (2\alpha^4 + \beta^4) s^2 + \frac{\lambda_k^8}{\alpha^8},$$

$$N_k(s) = s(s^2 \alpha^4 + \lambda_k^4) \frac{\lambda_k^2}{\alpha^8}.$$

The chosen optimal criterion gives the following condition for the dissipation coefficient:

$$\gamma_{\text{opt}} = \sqrt{2} \beta. \quad (12)$$

When this specification is met, the coincident poles become:

$$s_k = -\xi_k \pm i\omega_k,$$

where:

$$\xi_k = \frac{\lambda_k^2 \beta^2}{2\alpha^4}, \quad \omega_k = \frac{\lambda_k^2}{2\alpha^4} \sqrt{4\alpha^4 - \beta^4}.$$

Let us remark that the damping ratio is mode-independent, that is:

$$\zeta_k^{\text{PEM}} = \frac{\beta^2}{2\alpha^2}.$$

In order to show the damping efficiency of the so designed PEM plate let us show the evolution of $p_k(t)$ and $q_k(t)$ relative to the generic mode having an initial deflection velocity \dot{p}_k^0 :

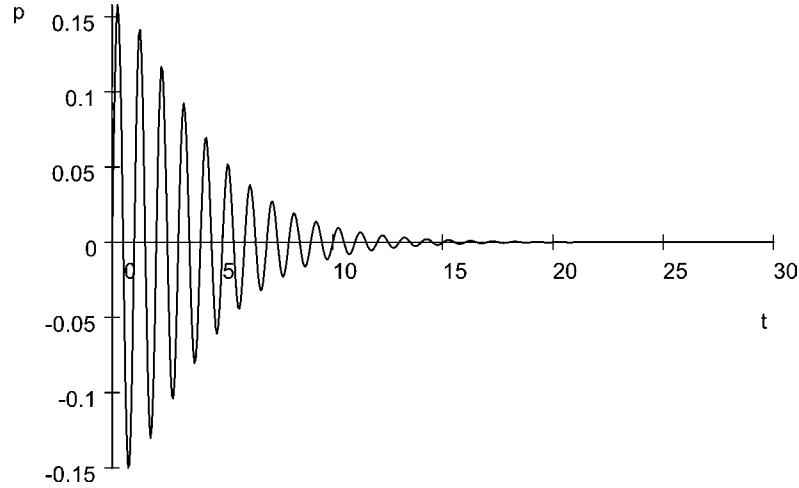

Fig. 6. Time evolution of $p_k(t)$. A characteristic time equal to the period of free vibrations of the k th mode has been chosen.

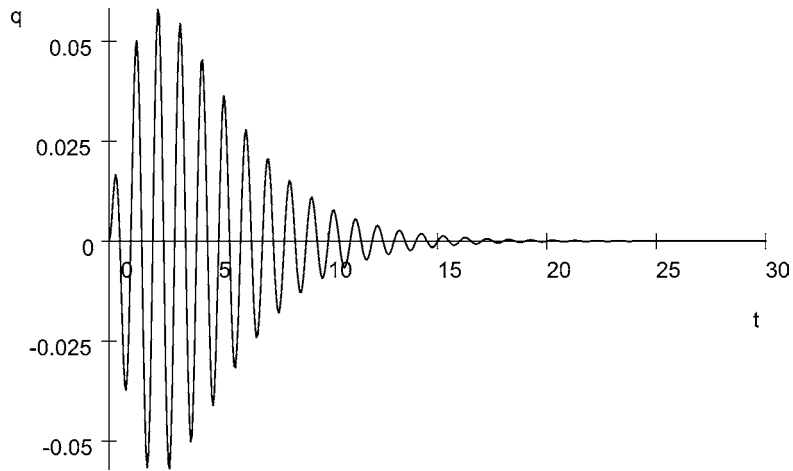

Fig. 7. Time evolution of $q_k(t)$. A characteristic time equal to the period of free vibrations of the k th mode has been chosen.

$$\begin{aligned}
 p_k(t) &= \dot{p}_k^0 e^{-t\xi_k} \left(\frac{\omega_k^2 - \xi_k^2}{\omega_k^3} \sin t\omega_k + t \frac{\xi_k}{\omega_k} \left(\sin t\omega_k + \frac{\xi_k}{\omega_k} \cos t\omega_k \right) \right), \\
 q_k(t) &= \dot{p}_k^0 e^{-t\xi_k} \left(-\frac{1}{\omega_k^3} \xi_k^2 \sin t\omega_k + t \frac{\xi_k}{\omega_k} \left(\sin t\omega_k + \frac{\xi_k}{\omega_k} \cos t\omega_k \right) \right).
 \end{aligned} \tag{13}$$

The electromechanical time evolutions (13), corresponding to $\dot{p}_k^0 = 1$, are depicted in Figs. 6 and 7. The mode-independent property of the presented methodology allows to sketch a unique diagram, valid for all the modes, provided that a characteristic time has been chosen equal to the k th period of the uncontrolled plate.

3. Comparison of the damping efficiency between the PEM plate and a plate connected to a BOD

In order to assess the efficiency of the PEM plate, let us compare its performances with those of a plate, the surface of which is connected to an array of linearly viscous dampers fixed to the ground. The governing equations of the plate connected to a BOD are:

$$\tilde{\nabla}^4 \tilde{u} + \alpha^4 \tilde{u} + \mu^2 \dot{\tilde{u}} = 0,$$

where the new symbol μ represent the damping coefficient of the bed of dampers. The equation for the mechanical Fourier coefficient $p_k(t)$ becomes:

$$\ddot{p}_k + \frac{\lambda_k^4}{\alpha^4} p_k + \frac{\mu^2}{\alpha^4} \dot{p}_k = 0,$$

where:

$$s_k = -\chi_k + i\varrho_k = \frac{1}{2\alpha^4} (-\mu^2 \pm \sqrt{\mu^4 - 4\alpha^4\lambda_k^4}) := \frac{1}{2\alpha^4} (-\mu^2 \pm \sqrt{\Delta_k}). \quad (14)$$

It is impossible to find a unique value of μ which guarantees a mode-independent optimal damping. If one wants to optimally damp the first structural mode then

$$\Delta_1 = 0 \Rightarrow \mu_{\text{opt}}(\lambda) = \sqrt{2}\alpha\lambda_1.$$

Thus, all the other modes remain underdamped, i.e.,

$$\Delta_k = 4\alpha^4(\lambda_1^4 - \lambda_k^4) < 0.$$

The modal damping ratios are

$$\zeta_k^{\text{BOD}} = \left(\frac{\lambda_1}{\lambda_k}\right)^2.$$

By comparing the damping ratio of the PEM plate with the one of the plate with bed of dampers, optimized for the dissipation of the mode λ :

$$\frac{\zeta_k^{\text{PEM}}}{\zeta_k^{\text{BOD}}} = \frac{\beta^2}{2\alpha^2} \left(\frac{\lambda_k}{\lambda_1}\right)^2$$

it is easily understood that for high structural modes the PEM plate always performs better than the BOD.

4. Conclusions

In this paper a novel device for damping multimodal plate vibrations is conceived, which is based on the concepts of distributed piezoelectric transduction and passive electric networks. The proposed strategy has been implemented in modelling and designing a Piezo-ElectroMechanical (PEM) Kirchhoff-Love (K-L) plate. The network provides a two-fold benefit: it enables an efficient electromechanical energy transformation and a purely electric dissipation. In order to assure a multimodal passive vibration control system, a completely passive circuit analog of a K-L plate has been synthesized and interconnected to an array of transducers uniformly distributed on the plate. The improvements with respect to the results found in Alessandroni et al. (2002) include: (i) the synthesis of a circuit constituted solely by passive components; (ii) a more accurate modelling of the PEM plate to account for those mechanical properties of piezoelectric transducers previously neglected; (iii) a mode-independent vibration damping, achieved via an optimal evaluation of floating resistors.

The closed-form solution for the free vibrations of the simply supported plate PEM plate has been worked out, in order to assess the mode-independent damping capabilities of proposed PEM plates. Finally, the performances comparison between the PEM plate and the plate connected to bed of dampers (BOD) is presented. The remarkable advantages exhibited by the presented PEM control technique are the following:

1. mode-independent optimal damping; on the contrary, the BOD performance is limited to a single-mode damping.
2. possibility of excluding physical ground, which is instead compulsorily required by the BOD.

The presented results seem to have possible technological applications in the design of shields for noise control.

We believe that an important and innovative aspect of this work consists in the new methodology adopted in the synthesis of the electric analog by means of a Lagrangian approach, which automatically lead to a completely passive circuit.

An interesting further development of this work could be the application of the presented methodology to PEM shells design.

Acknowledgement

The partial support of the Engineering Science and Mechanics Department of the Virginia Polytechnic Institute and State University is gratefully acknowledged by the authors. This presented research has been also partially supported by MIUR,

Ministero per l’Innovazione, l’Università e la Ricerca Fondi Ricerca PRIN “Sintesi di circuiti piezoelettrici e tecniche di disaccoppiamento per il controllo di vibrazioni meccaniche” (protocollo 2001097882_003) and by the Università di Roma “La Sapienza” Progetto di Ateneo “Soppressione delle vibrazioni mediante modifiche strutturali: modelli continui e discreti” (codice progetto C26A038198). The authors would like to thank the reviewers for their comments that led to a considerable improvement in the manuscript.

Appendix

All the plots presented in the previous sections have been realized considering a square plate of aluminum having the characteristics presented in Table 1.

The plate is assumed partially covered by square transducers produced by the Piezo System (see the web-site of PiezoSystem) having the properties shown in Table 2. It is worthwhile to notice that the key parameter for capturing higher modes is the sampling step ε , rather than the coverage factor η .

The characteristic quantities in the simulations are presented in Table 3.

The corresponding values for the analog circuital elements presented in Table 4.

Table 1
Plate constitutive parameters and dimensions

Parameters	Values
Young’s modulus (E)	$70 \times 10^9 \text{ N/m}^2$
Poisson ratio (ν)	0.3
Mass density (ρ)	2700 kg/m^3
Edge (l)	1 m
Thickness (h)	$2 \times 10^{-3} \text{ m}$

Table 2
Piezoelectric transducers constitutive parameters and dimensions

Parameters	Values
Young’s modulus (E_p)	$6.06 \times 10^{10} \text{ N/m}^2$
Poisson ratio (ν_p)	0.29
Mass density (ρ_p)	7500 kg/m^3
Thickness (δ)	$0.267 \times 10^{-3} \text{ m}$
Coupling coefficient (d_{31})	$-274 \times 10^{-12} \text{ m/V}$
Dielectric constant (ε_T)	$3.0104 \times 10^{-8} \text{ F m}^{-1}$
Coverage factor (η)	25%
Sampling step (ε)	0.1 m

Table 3
Characteristic quantities

Parameters	Values
Characteristic length (l_o)	1 m
Characteristic deflection (u_o)	10^{-3} m
Characteristic time (t_o)	1 s
Characteristic flux linkage (ψ_o)	0.85 V s

Table 4
Analog circuital quantities

Parameters	Values
$n^4 L_1$	371.72 H
C	$8.09 \times 10^{-8} \text{ F}$
R	$1.43 \times 10^5 \Omega$

References

- Alessandrini, S., dell'Isola, F., Porfiri M., 2002. A revival of electric analogs for vibrating mechanical systems aimed to their efficient control by PZT transducers. *Int. J. Solids Structures* 39 (20), 5279–5293.
- Andreas, U., dell'Isola, F., Porfiri M., 2004. Piezoelectric passive distributed controllers for beam flexural vibrations. *J. Vib. Control*, in press.
- Canon, E., Lenczner, M., 1999. Modelling of thin elastic plates with small piezoelectric inclusions and distributed electronic circuits. Models for inclusions that are small with respect to the thickness of the plate. *J. Elasticity* 55, 111–141.
- Crandall, S.H., Karnopp, D.C., Kurtz Jr., E.F., Pridmore-Brown, F.C., 1968. *Dynamics of Mechanical and Electromechanical Systems*. McGraw-Hill, New York.
- Crawley, E.F., Anderson, E.H., 1990. Detailed models of piezoceramic actuation of beams. *J. Intelligent Mater. Systems Structures* 1, 12–25.
- Fernandes, A., Pouget, J., 2002. An accurate modelling of piezoelectric multi-layer plates. *Eur. J. Mech. A Solids* 3 (4), 629–651.
- Forsyth, M.J., 1968. *Variational Calculus in Science and Engineering*. McGraw-Hill, New York.
- Hagood, N.W., von Flotow, A., 1991. Damping of structural vibration with piezoelectric materials and passive electric networks. *J. Sound Vib.* 146, 243–268.
- Hoffmann, K.H., Botkin, N.D., 1999. Homogenization of a model describing vibration of nonlinear thin plates excited by piezopatches. *Int. Ser. Numer. Math.* 133, 191–200.
- Hoffmann, K.H., Botkin, N.D., 2000. Homogenization of von Karman plates excited by piezoelectric patches. *Z. Angew. Math. Mech.* 80 (9), 579–590.
- Hollkamp, J.J., 1994. Multimodal passive vibration suppression with piezoelectric materials and resonant shunts. *J. Intelligent Mater. System Structures* 5, 49–57.
- IEEE Std 176-1987, IEEE Standard on Piezoelectricity. The Institute of Electrical and Electronic Engineers, 1987.
- Kader, M., Lenczner, M., Mrcarica, Z., 2001. Distributed control on distributed electronic circuits: application to vibration control. *Microelectronics Reliability* 41, 1857–1866.
- Maugin, G.A., 1980. The method of virtual power in continuum mechanics: application to coupled field. *Acta Mech.* 3, 1–70.
- Maurini, C., dell'Isola, F., Del Vescovo, D., 2004. Comparison of piezoelectronic networks acting as distributed vibration absorbers. *Mech. Systems and Signal Processing*, in press.
- Sze, K.Y., Yang, X.M., Fan, H., 2004. Electric assumptions for piezoelectric laminate analysis. *Int. J. Solids Structures*, in press.
- Vidoli, S., dell'Isola, F., 2000. Modal coupling in one-dimensional electro-mechanical structured continua. *Acta Mech.* 141, 37–50.
- Vidoli, S., dell'Isola, F., 2001. Vibration control in plates by uniformly distributed actuators interconnected via electric networks. *Eur. J. Mech. A Solids* 20, 435–456.