



HAL
open science

Inhibition of hepatocyte nuclear factor 4 transcriptional activity by the nuclear factor kappaB pathway

Varvara Nikolaidou-Neokosmidou, Vassilis I Zannis, Dimitris Kardassis

► **To cite this version:**

Varvara Nikolaidou-Neokosmidou, Vassilis I Zannis, Dimitris Kardassis. Inhibition of hepatocyte nuclear factor 4 transcriptional activity by the nuclear factor kappaB pathway. *Biochemical Journal*, 2006, 398 (3), pp.439-450. 10.1042/BJ20060169 . hal-00478524

HAL Id: hal-00478524

<https://hal.science/hal-00478524>

Submitted on 30 Apr 2010

HAL is a multi-disciplinary open access archive for the deposit and dissemination of scientific research documents, whether they are published or not. The documents may come from teaching and research institutions in France or abroad, or from public or private research centers.

L'archive ouverte pluridisciplinaire **HAL**, est destinée au dépôt et à la diffusion de documents scientifiques de niveau recherche, publiés ou non, émanant des établissements d'enseignement et de recherche français ou étrangers, des laboratoires publics ou privés.

**Inhibition of Hepatocyte Nuclear Factor 4 transcriptional activity by the
Nuclear Factor kappa B pathway**

Varvara Nikolaidou-Neokosmidou, Vassilis I. Zannis and Dimitris Kardassis #

Department of Basic Sciences, University of Crete Medical School and
Institute of Molecular Biology and Biotechnology, Foundation of Research and
Technology-Hellas, Heraklion 71003, Greece

Running title: Inhibition of HNF-4 by NF-κB

Corresponding author: Department of Basic Sciences,
University of Crete Medical School, Heraklion, Crete, GR-71003, Greece.

Tel #. +30-2810-394549, Fax #. +30-2810-394530,

e-mail: kardasis@imbb.forth.gr

SUMMARY

Hepatocyte Nuclear Factor 4 (HNF-4) is a key regulator of liver specific gene expression in mammals. We have shown previously that the activity of the human apolipoprotein C-III (APOC3) promoter is positively regulated by the anti-inflammatory cytokine Transforming Growth Factor β (TGF β) and its effectors Smad3 and Smad4 proteins via physical and functional interactions between Smads and HNF-4. We now show that the pro-inflammatory cytokine Tumor Necrosis Factor α (TNF α) antagonizes TGF β for the regulation of APOC3 gene expression in hepatocytes. TNF α was a strong inhibitor of the activity of apolipoprotein promoters that harbor HNF-4 binding sites and this inhibition required HNF-4. Using specific inhibitors of TNF α -induced signaling pathways it was shown that inhibition of the APOC3 promoter by TNF α involved Nuclear Factor kappa B (NF- κ B). Latent Membrane Protein 1 of Epstein Barr Virus which is an established, potent activator of NF- κ B as well as wild type forms of various NF- κ B signaling mediators also inhibited strongly the APOC3 promoter and the transactivation function of HNF-4. TNF α had no effect on the stability or the nuclear localization of HNF-4 in HepG2 cells but inhibited the binding of HNF-4 to the proximal APOC3 HRE. Using the GAL4 system, we showed that both Activation Functions of HNF-4 (AF-1 and AF-2) are inhibited by TNF α and that this inhibition was abolished by overexpression of different HNF-4 coactivators including PGC-1, CBP and SRC3. In summary, our findings indicate that TNF α or other factors that trigger an NF- κ B response in hepatic cells inhibit the transcriptional activity of the APOC3 and other HNF-4-dependent promoters and

that this inhibition could be accounted for by a reduction in DNA binding and the downregulation of the transactivation potential of the AF-1 and AF-2 domains of HNF-4.

Keywords: HNF-4, NF- κ B, transcriptional inhibition, APOC3, TNF α , coactivators

Abbreviations: AF: Activation Function; APOA1: apolipoprotein A-I; APOA4: apolipoprotein A-IV; APOC3: apolipoprotein C-III; CBP: CREB binding protein; DBD: DNA Binding Domain; DMEM: Dulbecco's Modified Eagle's medium; FBS: Fetal Bovine Serum; HEK 293T: human embryo kidney 293T; HNF-4: Hepatocyte Nuclear Factor 4; HRE: hormone response element; LBD: Ligand Binding Domain; LMP1: Latent Membrane Protein 1; NF- κ B: Nuclear Factor kappa B; ONPG: O-nitrophenyl-galactopyranoside; PBS: phosphate-buffered saline; PGC-1: peroxisome proliferator activated receptor gamma coactivator 1; RHD: Rel Homology Domain; TGF β : Transforming Growth Factor β ; TNF α : Tumor Necrosis Factor α ; SRC3: steroid receptor coactivator 3;

INTRODUCTION

Hepatocyte Nuclear Factor 4 (HNF-4) belongs to the hormone nuclear receptor gene superfamily of transcription factors on the basis of its domain architecture which is characterized by the presence of an N-terminal Activation Function 1 (AF-1), a DNA binding domain (DBD) of the zinc-finger type and a multifunctional ligand binding domain (LBD) which harbors Activation Function 2 (AF-2) and is connected with the DBD by a hinge region [1-4]. Although HNF-4 belongs to a subclass of nuclear receptors termed “orphan”, it was recently shown that fatty acids may constitute endogenous ligands of HNF-4 [5-7]. HNF-4 also harbors an inhibitory C-terminal domain which modulates the binding of coactivators to the adjacent AF-2 [4, 8]. The AF-1 and AF-2 domains of HNF-4 have been shown to interact with different members of the p160 family of coactivators including SRC-1 and GRIP1/TIF2 [9-11], as well as with the histone acetyltransferase CREB-binding protein (CBP) [12]. CBP acetylates HNF-4 and this modification has been shown to regulate several functions of HNF-4 including DNA binding, nuclear accumulation and interaction with coactivators [13]. In addition, HNF-4 interacts with the peroxisome proliferator activated receptor gamma coactivator 1 (PGC-1), a protein that plays important roles in hepatic gluconeogenesis [11,14].

HNF-4 is predominantly expressed in the liver, intestine, pancreas and kidney and regulates the expression of genes and gene networks with important physiological roles in the above organs [2]. Conditional inactivation of HNF-4 in the liver of mice caused weight loss, increased rate of mortality and lipid abnormalities due to impaired expression of HNF-4-regulated genes involved in

lipid and bile acid metabolism and transport [15]. Among the genes that were transcriptionally silenced by the inactivation of HNF-4 in the liver was the apolipoprotein C-III gene [15].

Apolipoprotein C-III (APOC3) has been implicated in the modulation of binding of apoE-containing lipoproteins to cell receptors and their subsequent catabolism [16-20]. The importance of APOC3 in triglyceride homeostasis is supported by studies in transgenic mice in which overexpression of the APOC3 gene was found to be associated with severe hypertriglyceridemia due to the defective clearance of triglyceride-rich lipoprotein remnants [21,22].

The human APOC3 gene is closely linked to the human apoA1 and apoA4 genes on the long arm of chromosome 11 [23]. In vitro mutagenesis established that three hormone response elements (HREs), located in the proximal promoter and enhancer as well as three Sp1 binding sites located in the APOC3 enhancer are important for the APOC3 gene expression in hepatic cells [24-28]. Two of the above HREs (elements B and I) bind HNF-4 and other orphan and ligand-dependent nuclear receptors [25-28].

Previous studies have demonstrated that the APOC3 gene is downregulated during the acute phase-response due to the action of pro-inflammatory cytokines such as tumor necrosis factor- α (TNF α) and interleukin-1 (IL-1) [29, 30]. Transcription factors found previously to mediate this process include the Activation Protein-1 (AP-1) proteins c-jun and activating transcription factor 2 (ATF-2) as well as the CAAT/Enhancer Binding Protein δ (C/EBP δ) [30,31]. Natural extinguishing of the acute phase response occurs in part due to

the production of anti-inflammatory cytokines such as interleukin-10, interleukin-13, and Transforming Growth Factor β (TGF β) [32]. TGF- β and its signaling mediators, the Smad proteins, are potent anti-inflammatory cytokine in mammals [33-36].

We have shown recently that TGF β and its signal transducers Smad proteins transactivate the APOC3 gene promoter by interacting physically and functionally with HNF-4 that binds to the proximal APOC3 HRE (element B) [37,38]. We now show that the pro-inflammatory cytokine Tumor Necrosis Factor α (TNF α) antagonizes TGF β for the regulation of APOC3 gene expression in hepatocytes. Inhibition of the APOC3 promoter by TNF α requires the participation of the NF- κ B pathway which affects the DNA binding and transactivation potential of HNF-4.

MATERIALS AND METHODS

Materials

All reagents for cell culture including Dulbecco's Modified Eagle's Medium (DMEM), Fetal Bovine Serum (FBS), Trypsin-Ethylene Diamine Tetraacetic Acid (Tryprin-EDTA) and Phosphate-Buffered Saline (PBS) were purchased from Life Technologies. O-nitrophenyl-galactopyranoside (ONPG), phenylmethylsulfonyl fluoride, the anti-FLAG (M2) mouse monoclonal antibody and the anti- β tubulin mouse monoclonal antibody were purchased from Sigma. The anti-HNF-4 (C-19) goat polyclonal antibody and anti-NF- κ B p65(A) rabbit polyclonal antibody were purchased from Santa Cruz Biotechnology. The anti-pERK and anti-ERK antibodies were gifts of Dr G. Mavrothalassitis (University of Crete, Heraklion, Greece). The rabbit anti-HNF-4 antibody was a kind gift of Dr Iannis Talianidis (IMBB-FORTH, Heraklion). The dNTPs, poly dl/dC and the G Sepharose beads were purchased from Amersham-Pharmacia. The luciferase assay kit and random hexamers were purchased from Promega. The MEK1 inhibitor U0126 was purchased from Upstate. Human recombinant TNF α was purchased from Roche and Minotech. Human recombinant TGF β was purchased from R&D Systems. The Super Signal West Pico Chemiluminescent Substrate was purchased from Pierce. Streptavidin Dynabeads were purchased from Dynal Biotech. Superscript reverse transcriptase was purchased from Invitrogen. Oligonucleotides were synthesized at the Microchemistry laboratory of the Foundation for Research and Technology-Hellas.

Cell Culture, transient transfections and reporter assays.

Human hepatoma HepG2 cells, human embryo kidney (HEK) 293T cells and COS-7 fibroblasts were cultured in Dulbecco's Modified Eagle's Medium (DMEM), supplemented with 10 % Fetal Bovine Serum (FBS) and penicillin-streptomycin, in a 37°C, 5% CO₂ incubator. Human recombinant TNF α (0, 250, 500, 1,000 units), TGF β (0, 40, 80 pM) or the MEK1 inhibitor U0126 (10 μ M) were added to the cell culture medium for different time periods. Transient transfections were performed by the Ca₃(PO₄)₂ co-precipitation method using 6 μ g of DNA/well when the transfections were performed in 6-well plates or 35 μ g/plate when transfections were performed in P-100 plates. Luciferase assays were performed using the Luciferase assay kit from Promega Corp. according to the manufacturer's instructions. Normalization for transfection efficiency was performed by β -galactosidase assays.

Plasmids

The apolipoprotein promoter plasmids APOC3 (-890/+24)-Luc, APOC3 (-686/+24)-Luc, APOC3 (-99/+24)-Luc, APOC2 (-550/+18)-Luc, APOA4 (-700/+24)-Luc, the NF- κ B responsive vector (NF- κ B)₃-Luc and expression vectors for LMP1, NIK, IKK β , I κ B-ND, p65, p50, p50-p65 hyb and Smad proteins (Smad3, Smad4) have been described previously [24, 38-41]. Expression vectors for wild type or truncated forms of rat HNF-4a1 in expression vector pCDNA1-amp or fused with the DNA binding domain of GAL4 were kindly provided by Dr Margarita Hadzopoulou-Cladaras (Department of Biology, Aristotelian University

of Thessaloniki, Greece). The expression vector for the human PGC-1 coactivator was a kind gift of Dr Anastasia Kralli (Department of Cell Biology, The Scripps Research Institute, La Jolla, CA, USA). The expression vector for the human CBP coactivator was a kind gift of Dr Ioannis Talianidis (Institute of Molecular Biology and Biotechnology of Crete, Heraklion). The expression vector for the human SRC3 coactivator was a kind gift of Dr Hinrich Gronemeyer (IGBMC, Illkirch, Strasbourg, France)

Reverse Transcription PCR

HepG2 cells were treated with 1,000 units of TNF α in the absence or in the presence of TGF β (40 and 80pM) for 24 hr or left untreated, total RNAs were prepared and equal concentrations of RNAs were used for cDNA synthesis. The synthesis of cDNAs was performed using Superscript reverse transcriptase and random hexamers as primers. The cDNAs were used for PCR amplifications with primers corresponding to the human APOC3 cDNA. The sequences of the primers were as follows: APOC3 forward primer, 5' AGGAGTCCCAGGTGGCCCAGCAG 3'; APOC3 reverse primer, 5' CACGGCTGAAGTTGGTCTGACCTCA 3'.

Indirect Immunofluorescence.

HepG2 cells or transfected COS-7 cells were seeded on glass coverslips, coated with 0.1% gelatin. Cells were washed three times on a slow rotating platform with PBS+/+ (PBS plus 0.9 mM CaCl₂ and 0.5 mM MgCl₂) and fixed with 3% p-

formaldehyde in PBS +/- for 5 min at room temperature. Cells were washed three times with PBS +/- and permeabilized with 0.5% Triton X-100 in buffer 1 (10X buffer 1: 137 mM NaCl, 5 mM KCl, 1 mM Na₂HPO₄, 0.4 mM KH₂PO₄, 5.5 mM glucose, 4 mM NaHCO₃, 2 mM MgCl₂, 2 mM EDTA, 2 mM EGTA, 20 mM MES, pH 6.0-6.5) for 5 min at room temperature. Cells were washed three times with PBS +/-, blocked with PBS +/-/1.5% FBS and incubated with the primary antibody (1:200 dilution, in PBS +/-/1.5% FBS) for 30 min at 4°C. Cells were washed three times with PBS +/- /1.5% FBS and incubated with the secondary antibody (1:50 dilution in PBS +/-/1.5% FBS) for 30 min at 4°C in the dark. Cells were washed three times with PBS +/- in the dark and mounted on glass slides using mounting solution (1:1 glycerol/PBS). Cells were observed using a Leica SP confocal fluorescent microscopy.

Western blotting

For Western blotting analysis of endogenous (HepG2) or transfected (HEK-293T) proteins, cells were trypsinized, pelleted by centrifugation at 2,000 rpm for 5 min, washed 1X with ice-cold phosphate-buffered saline, re-centrifuged as above and resuspended in lysis buffer (50mM Tris-HCl pH=7.4, 150mM NaCl, 1% NP-40, 0.25% sodium deoxycholate, 1 mM EGTA) supplemented with protease inhibitors (1 mM phenylmethylsulfonyl fluoride, 1 µg/ml pepstatin and 1 µg/ml leupeptin). Extracts were allowed to rotate at 4°C for 30 min and centrifuged at 13,000 rpm for 5 min at 4°C. Protein concentration was measured using the Dc Protein Assay kit and equal amounts were loaded on 10.5 % SDS-polyacrylamide gel

electrophoresis followed by electrotransfer to Protran nitrocellulose transfer membrane 0,45 μm (S & S). Immunoblotting was performed using appropriate monoclonal or polyclonal antibodies followed by incubation with horseradish peroxidase-conjugated secondary antibodies. Proteins were visualized by enhanced chemiluminescence.

Chromatin immunoprecipitations

The chromatin immunoprecipitation assay was performed as described previously [42] using chromatin from HepG2 cells and a rabbit polyclonal antibody for human HNF-4. Immunoprecipitated chromatin was analyzed by PCR using primers corresponding to the proximal (-233/-21) and distal (-882/-518) regions of the human APOC3 promoter. The proximal APOC3 promoter primers were: P1: 5' CAG GCC CAC CCC CAG TTC CTG AGC TCA 3'; P2: 5' CCT GTT TTA TAT CAT CTC CAG GGC AGC AGG C 3'. The distal APOC3 promoter primers were: D1: 5' AGT TGC TCC CAC AGC CAG GGG GCA GT 3'; D2: 5' TCT CAC AGC CCC TCC CAG CAC CTC CAT 3'. The products of the PCR amplifications (35 cycles) were analyzed by agarose gel electrophoresis and ethidium bromide staining.

DNA affinity precipitation

For DNA affinity precipitation, nuclear extracts from HepG2 cells that had been treated with TNF α (1,000u) for 24h or from untreated HepG2 cells were used. Dynabeads (DynaL Biotech) were washed one time with 1XB&W buffer (5mM Tris-HCl pH 7.5, 0,5mM EDTA, 1mM NaCl), mixed with 0,58 μM of biotinylated

oligonucleotide and incubated at RT for 15 min. The oligonucleotide-coupled beads were washed two times with 1XB&W buffer and one time with 1XBBRC buffer (10% glycerol, 10mM Tris pH 7.5, 50mM KCl, 4mM MgCl₂, 0.2mM EDTA).

The protein-DNA binding reactions were performed for 30 min on ice in a buffer containing 10% glycerol, 20mM Hepes pH 7.9, 40mM KCl, 20mM MgCl₂, 4mM Spermidine, 100 µg/ml BSA, 0.02mM Zn acetate, 0.05% NP40 and 0.5mM DTT. Each reaction included 30 µg of nuclear extracts, 3 µg of competitor poly dl/dC and the biotinylated oligonucleotide-coupled dynabeads that were prepared as describe above in a total reaction volume of 50 µl. Biotinylated oligonucleotides corresponding to the -92/-67 region of the human APOC3 promoter [28] and the -86/-70 region of the human p21^{Cip1} promoter [43] were utilized. HNF-4 bound to the oligonucleotides was detected by SDS-PAGE and immunoblotting using a polyclonal anti-HNF-4 antibody.

RESULTS

Antagonistic effects between TGF β and TNF α on the activity of the human APOC3 promoter in HepG2 cells. Negative cross talk between the TGF β and TNF α signaling pathways on the activity of the human APOC3 promoter was investigated by transactivation assays in human hepatoma-derived HepG2 cells. For this purpose, HepG2 cells were transfected with a plasmid bearing the firefly luciferase reporter gene under the control of the promoter of the human apolipoprotein C-III gene between nucleotides -890 and +24 (APOC3 -890/+24-Luc) and were treated with increasing amounts of recombinant human TNF α (250, 500, 1000 units) for 24 hr. As shown in Fig. 1A, TNF α treatment inhibited the activity of the APOC3 promoter in a dose-dependent manner. This finding was in agreement with previous observations showing that TNF α inhibited the transcription of the human APOC3 gene in HepG2 cells [29].

It was next shown that the inhibitory effect of TNF α on the APOC3 promoter could be overcome by the simultaneous treatment of HepG2 cells with increasing doses of human recombinant TGF β (Fig. 1B) suggesting a negative cross talk between the two pathways operating on the APOC3 promoter. Inhibition of APOC3 promoter activity by TNF α could also be abrogated by overexpression of Smad3 and Smad4 proteins which are the key effectors of the TGF β pathway (Fig. 1C). In agreement with the data of Fig. 1B, treatment of HepG2 cells with TNF α (1,000 units) for 24 hrs caused a reduction in the steady state mRNA levels of the human APOC3 gene and this inhibition could be

overcome by the simultaneous treatment of HepG2 cells with increasing doses (40 and 80pM) of TGF β (Fig. 1D).

In conclusion, the data of Fig. 1 combined with our previous findings [27,28,30,37,38] indicate that the activity of the human APOC3 promoter in HepG2 cells can be modulated by positive and negative signals which are produced by anti-inflammatory and pro-inflammatory cytokines respectively. This is shown schematically in Figure 1E.

Inhibition of APOC3 promoter activity by TNF α is mediated by NF- κ B. To identify and characterize the signaling pathway(s) that (is) are responsible for the TNF α -induced inhibition of APOC3 promoter activity in HepG2 cells, two inhibitors that specifically block well characterized and distinct TNF α -induced signaling cascades were utilized: a mutant that blocks the cascade leading to NF- κ B activation (a dominant negative, non-degradable form of the I κ B inhibitor that keeps NF- κ B in the cytoplasm, I κ -ND) and a chemical inhibitor (the MEK1 inhibitor U0126) that blocks the cascade leading from TNF α to the Extracellular Signal Regulated Kinase (ERK). First, the activation of the above signaling cascades by TNF α in HepG2 cells was shown by well established assays such as the TNF α -induced p65 nuclear translocation (Fig. 2A) and the TNF α -induced phosphorylation of ERK (Fig. 2B). Then the effect of the two inhibitors on the constitutive as well as on the TNF α -inducible activity of the APOC3 promoter was evaluated. As shown in Fig. 2C, inhibition of the APOC3 promoter by TNF α was totally abolished in the presence of the I κ B-ND inhibitor. In fact, a strong

activation of the APOC3 promoter was observed by the NF- κ B inhibitor even in the absence of TNF α indicative of the existence of strong endogenous negative signals in HepG2 cells that constitutively inhibit APOC3 promoter activity via the NF- κ B pathway. In contrast, the U0126 inhibitor of the MEK1/ERK pathway had only a minor positive effect on both the basal and the TNF α -inhibited APOC3 promoter activity (Fig. 2C).

Next, the effect of selected NF- κ B signaling effectors on APOC3 promoter activity in HepG2 cells was investigated by transactivation assays. Figure 2D shows that overexpression of IKK β kinase inhibited APOC3 promoter activity in a dose-dependent manner and Fig. 2E shows that overexpression of the p65/relA subunit of NF- κ B totally abolished APOC3 promoter activity whereas the p50 subunit had no effect. Finally, a hybrid p65 protein in which the Rel Homology Domain (RHD) of p65 was swapped by the corresponding domain of p50 (p50-p65 hyb) was as effective as full length p65 in inhibiting the APOC3 promoter suggesting that the inhibition is mediated by the C-terminal transactivation domain of p65.

As an additional confirmation of the inhibitory role played by NF- κ B in APOC3 promoter regulation, the Latent Membrane Protein 1 (LMP1) of Epstein Barr Virus was utilized in transactivation assays. LMP1 is a protein homologous to TNF α receptor that has been shown previously to be a potent activator of the NF- κ B pathway in various cell types [44]. In a control experiment, it was established that LMP1 strongly activated a NF- κ B-responsive promoter [(NF- κ B)₃] in HepG2 cells and this activation was inhibited by the dominant negative

I κ B-ND mutant (Fig. 2F). More importantly, it was shown that a small amount of LMP1 was sufficient to fully block APOC3 promoter activity in HepG2 cells (Fig. 2G).

In summary, the findings of Figure 2 indicate that activation of the NF- κ B pathway in HepG2 cells by TNF α causes a strong inhibition of the APOC3 promoter activity. The molecular mechanism of this inhibition was the subject of the subsequent experiments presented below.

The proximal Hormone Response Element of the APOC3 promoter is sufficient to mediate inhibition by TNF α . To identify the region of the APOC3 promoter that responds to TNF α , two truncated APOC3 promoter fragments were utilized in transactivation experiments in HepG2 cells. One mutant (APOC3 -686/+24) lacks the region between nucleotides -890 and -687 which includes the distal enhancer elements F-J (Fig. 3A). The second mutant (APOC3 -99/+24) contains the region between nucleotides -99 and +24 which includes only the proximal element B (Fig. 3A). Element B was shown previously to harbor an HRE that binds a selection of orphan and ligand-dependent nuclear receptors including HNF-4 [27,28]. Mutagenesis of this element abolished APOC3 promoter activity both in vitro and in vivo [27,28].

As shown in Fig. 3B, both APOC3 promoter mutants were inhibited by TNF α and LMP1 to approximately the same degree as the full length APOC3 promoter. The minimal region of the APOC3 promoter required for TNF α or LMP1-induced inhibition is the -99/+24 since further deletion of the APOC3

promoter to nucleotide -55 abolished both the constitutive and the TNF α -inhibited APOC3 promoter activity (data not shown).

The data of Figure 3 indicate that inhibition of the APOC3 promoter activity by TNF α could be mediated, at least in part, by interfering with the activity of nuclear receptors that bind to the proximal APOC3 HRE.

TNF α inhibits the HNF-4-mediated transactivation of the APOC3 and APOC2 promoters. Previous *in vivo* studies have established that HNF-4 is the single most important regulator of the expression APOC3 as well as of other apolipoprotein genes in hepatocytes [15]. It was shown previously that HNF-4 binds with high affinity to the proximal HRE B of the APOC3 promoter *in vitro* [28]. The recruitment of HNF-4 to the APOC3 promoter *in vivo* was established here by a chromatin immunoprecipitation experiment. As shown in Fig. 4B, HNF-4 was recruited to the proximal APOC3 promoter region -230/-20 that includes HRE B but, surprisingly, it failed to bind to the distal region -880/-520 that harbors the distal HREs G and I.

It was then shown that HNF-4 strongly transactivated the APOC3 (-890/+24) promoter in HepG2 cells and that this transactivation was inhibited by TNF α or LMP1 expression (Fig. 4C). A similarly negative effect of TNF α and LMP1 on HNF-4-mediated transactivation was observed using the APOC2 promoter (Fig. 4D) that also contains a binding site for HNF-4 (HRE B, Fig. 4A). To confirm the requirement of HNF-4 for the TNF α and LMP1-induced inhibition of the APOC3 promoter, transactivation experiments were performed in HEK-

293T cells that lack endogenous HNF-4. As shown in Fig. 4E, TNF α or LMP1 had no effect on the activity of the APOC3 promoter in HEK-293T cells whereas they strongly inhibited the HNF-4 mediated transactivation of the same promoter. As a negative control, the human APOA4 promoter (-700/+10) was utilized. This promoter cannot be transactivated by HNF-4 despite the presence of a HNF-4 binding site in the proximal region (Fig. 4A and E) [40].

In summary, the findings of Figure 4 indicate that TNF α and other NF- κ B activating factors can inhibit the activity of a certain set of promoters harboring HNF-4 binding sites and that HNF-4 is required for this inhibition.

TNF α does not affect the nuclear localization or the stability of HNF-4. To investigate further the mechanism of inhibition of HNF-4-mediated transactivation by TNF α , the effect of TNF α and LMP1 on HNF-4 nuclear localization and stability was examined. Using immunofluorescence analysis, it was shown that the constitutive nuclear accumulation of HNF-4 in HepG2 cells was not affected following treatment with TNF α for 24 hr (Fig. 5A). In a double immunofluorescence experiment, it was shown that, similar to TNF α , LMP1 had no effect on HNF-4 nuclear localization in HEK293T cells that had been cotransfected with both factors (Fig. 5B). Immunoblotting analysis clearly showed that neither TNF α nor LMP1 affected the stability of endogenous HNF-4 in HepG2 cells (Fig. 5C) or exogenous HNF-4 in HEK-293T cells (Fig. 5D).

TNF α modifies the DNA binding properties of HNF-4. It was next examined whether TNF α affected the DNA binding properties of HNF-4. For this purpose a DNA affinity precipitation experiment was performed using endogenous HNF-4 in HepG2 cells and a biotinylated double stranded oligonucleotide corresponding to the -92/-67 region of the APOC3 promoter that includes the proximal HRE. As shown in Fig. 5E, HNF-4 bound efficiently to the proximal APOC3 (-92/-67) oligonucleotide and this binding was inhibited by TNF α . In control experiments it was shown that HNF-4 did not bind to the streptavidin dynabeads or to a double stranded synthetic oligonucleotide corresponding to the -86/-70 region of the human p21^{Cip1} promoter [43].

TNF α and NF- κ B inhibit the transcriptional activation function of HNF-4 by modulating the activity of AF-1 and AF-2 domains. In the next series of experiments, the effects of the NF- κ B pathway on nuclear HNF-4 functions was investigated using the well characterized GAL4 system. For this purpose, a fusion protein consisting of full length rat HNF-4a1 (aa 1-455) fused with the DNA Binding Domain of the yeast transactivator GAL4 (aa 1-147) (Fig. 6A) was transiently expressed in HepG2 cells and its ability to transactivate the GAL4-responsive artificial promoter G5B (consisting of 5 tandem GAL4 binding sites) in the presence or in the absence of different NF- κ B pathway activators and effectors was evaluated by luciferase assays. As shown in Fig. 6B, TNF α strongly inhibited the transcriptional activity of GAL4-HNF-4 in HepG2 cells. This repression could be partially reversed by the dominant negative I κ B-ND mutant

but not by the MEK1 inhibitor U0126 in agreement with the findings of Fig. 2C. The transcriptional activity of GAL4-HNF-4 was also inhibited by LMP1 as well as by different effectors of the TNF α and LMP1 pathways including the NIK, the IKK β kinase and the p65/RelA subunit of NF- κ B (Fig. 6C). Finally, it was shown that p65 inhibited not only the constitutive, but also the Smad-inducible transcriptional activity of HNF-4 (Fig. 6D). The latter findings suggested that the antagonistic effects between TGF β and TNF α on the APOC3 promoter shown in Fig. 1B could be accounted for by antagonistic interactions between their signaling effectors (NF- κ B and Smad proteins) with HNF-4 that binds to the APOC3 promoter.

Using various truncated forms of HNF-4 fused with the DNA binding domain of GAL4 (Fig. 7A) it was shown that both transactivation domains of HNF-4 (AF-1 and AF-2) respond to the inhibitory effects of TNF α . As shown in Fig. 7B and C, TNF α , LMP1 and p65 strongly inhibited the transcriptional activity of HNF-4 mutants 1-174 and 1-49 which contain only the transactivation domain AF-1. TNF α had a similar inhibitory effect on two HNF-4 mutants lacking the AF-1 domain but retaining the AF-2 domain (mutants 48-455 and 175-370).

Different coactivators have been shown previously to activate the transactivation function of the AF-1 and AF-2 domains of HNF-4. Among them are coactivators which show preference for the AF-2 domain such as the peroxisome proliferator activated receptor gamma coactivator 1 (PGC-1) and coactivators that act via both domains such as CBP/p300 and SRC3 [9-14]. The findings of this study presented in Figures 6-7 suggested that TNF α , via the NF-

κ B pathway, interfere with the nuclear functions of HNF-4 and specifically with the transactivation functions of AF-1 and AF-2. The involvement of coactivators in the mechanism of repression of HNF-4 by TNF α was investigated by transactivation assays in HepG2 cells. Figure 8A shows that the inhibitory effect of TNF α on GAL4-HNF-4 could be totally abolished by overexpression of the HNF-4 coactivators CBP, SRC3 and PGC-1. PGC-1 in particular not only abolished inhibition by TNF α but induced a strong coactivation of GAL4-HNF-4 (4-fold above basal, uninduced levels) (Fig. 8A last bar). PGC-1 had a similar positive effect under conditions of GAL4-HNF-4 inhibition by LMP1 (Fig. 8B, third and fourth bar).

To investigate potential competition between HNF-4 and NF- κ B for common coactivators, the ability of PGC-1 to function as a coactivator of LMP1 signaling to NF- κ B was examined. As shown in Fig. 8C, PGC-1 strongly coactivated LMP1 in a transactivation assay in which the artificial promoter (NF- κ B)₃ was used suggesting that PGC-1 may act as a coactivator of LMP1 signaling to NF- κ B. Competition between HNF-4 and LMP1 for PGC-1 was specific for the AF-2 domain of HNF-4 (compare GAL4-HNF-4 (48-455) lacking AF-1 in Fig. 8D with GAL4-HNF-4 (1-49) that contains only AF-1 in Fig. 8E). In contrast, CBP was equally active on both AF-1 and AF-2 domains (Fig. 8 D,E)

The findings of Figure 8 suggested that TNF α and LMP1-induced inhibition of HNF-4 transcriptional activity could be accounted for, at least in part, by interference with the recruitment of coactivators that interact with both the AF-1 and AF-2 domains of HNF-4.

Discussion

The findings of this study indicate that pro-inflammatory cytokines such as TNF α that activate multiple signalling pathways including NF- κ B can inhibit the expression of liver-specific genes by a novel mechanism that involves the modification of the DNA binding and the transactivation properties of a hormone nuclear receptor such as HNF-4. This mechanism seems to be important for the negative cross talk between the TNF α and the anti-inflammatory cytokine TGF β on the expression of the apolipoprotein C-III gene during the acute phase response, a process by which organisms respond to various conditions such as infections, ischemic necrosis and trauma [32]. This is not the first example of a negative cross talk between the two cytokines. TGF β /TNF α antagonism regulates the expression of the collagen genes and is very important for the control of tissue homeostasis and repair [45]. However, in the case of the collagen genes, the JNK MAPK pathway rather than nuclear receptors is involved in this antagonism [46].

The participation of nuclear receptors in the mechanism of transcriptional inhibition of the APOC3 gene by TNF α was suggested by the results of transactivation experiments in which deletion mutants of the APOC3 promoter were utilized. These experiments showed that the proximal HRE (element B) was sufficient to mediate repression by TNF α (Fig. 3). Previous *in vitro* studies had established that this proximal HRE of the APOC3 promoter is of the DR1 type (Direct Repeat with 1 nucleotide spacing) and strongly binds HNF-4 as well as, ARP-1, EAR-2, EAR-3, and heterodimers of RXR α with RAR α and less efficiently

binds homodimers of RAR α and heterodimers of RXR α with T3R β or PPAR α [27,28]. Among the nuclear receptors that bind to this HRE, HNF-4 seems to play the prominent role as conditional inactivation of HNF-4 in the liver abolished the expression of the APOC3 gene [15]. However, *in vivo* evidence for the recruitment of HNF-4 to this HRE as well as the HRE of the APOC3 enhancer in hepatic cells was missing. By performing a chromatin immunoprecipitation assay, we were able to demonstrate for the first time here the constitutive recruitment of HNF-4 to the proximal HRE of the APOC3 promoter in HepG2 cells (Fig. 4B). Surprisingly, HNF-4 was not found on the distal HRE of the APOC3 enhancer which was shown previously to bind HNF-4 *in vitro* and to be crucial for the expression of the APOC3 and APOA1 genes *in vitro* and *in vivo* (Fig. 4B) [27,28,47]. This finding could suggest that nuclear receptors other than HNF-4 are the predominant regulators of APOC3 gene via the distal HRE but this has to be confirmed by additional *in vivo* DNA binding experiments. The recruitment of nuclear receptors other than HNF-4 on the proximal HRE and their involvement in transcriptional responses to extracellular signal also need to be thoroughly investigated.

Using GAL4-HNF-4 fusion proteins and different NF- κ B inducing agents such as TNF α and the LMP1 transforming protein of the Epstein Barr Virus, we provide strong evidence for the involvement of the NF- κ B pathway in the nuclear functions of HNF-4. (Fig. 6). This could be explained by different, not necessarily mutually exclusive mechanisms: a) An indirect mechanism such as the transcriptional activation of an HNF-4 inhibitor by NF- κ B. Such an inhibitor could

be the small heterodimer partner (SHP) which was shown to physically interact with HNF-4 and inhibit its transcriptional activity [48]. This hypothesis is supported by the findings of Fig. 2E which showed that inhibition of HNF-4 requires the transactivation domain of the p65/Rel subunit of NF- κ B; β) Inhibition could be accomplished by interference of NF- κ B with the recruitment or functions of different HNF-4 coactivators. HNF-4 has been shown to interact with members of the p160 family of coactivators including SRC-1 and GRIP1/TIF2 as well as with the histone acetyltransferase CREB-binding protein (CBP) and with PGC-1, a coactivator that plays important roles in hepatic gluconeogenesis [8-14]. In agreement with this hypothesis are the data presented in Fig. 8 of this study which showed that inhibition of HNF-4 by TNF α or LMP1 was overcome by overexpression of different HNF-4 coactivators including CBP, SRC3 and PGC1 which interact with distinct transactivation domains of HNF-4 (AF-1 and AF-2) and that at least one of these proteins (PGC-1) may function as coactivator of NF- κ B signaling (Fig. 8C).

In addition to the negative effect of the TNF α /NF- κ B pathway on the transactivation properties of HNF-4, TNF α appears to modify the DNA binding properties of this transcription factor as well. As shown in Fig. 5E, HNF-4 present in nuclear extracts from HepG2 cells that had been pre-treated with TNF α has a lower affinity for the proximal APOC3 HRE than HNF-4 present in untreated cells. This may be due to a modification such as phosphorylation of HNF-4 in the DNA Binding Domain that affects its affinity for DNA. In support of this hypothesis are previous studies which have shown that the DNA binding properties of HNF-4

can be modulated in a positive or a negative manner by modifications such as acetylation [13] and phosphorylation which is induced by different signal transduction pathways involving MAP and JAK kinases [49,50].

In summary, the present as well as previous studies from our group showed that the orphan nuclear receptor HNF-4 may have an important role in hepatic gene regulation not only as a constitutive transcriptional activator but also as a “*molecular switch*” utilized by pro-inflammatory (TNF α , IL1) or anti-inflammatory (TGF β) cytokines in order to induce or inhibit the expression of a selection of HNF-4 target genes during conditions of inflammation. The mechanism of inhibition of HNF-4 transcriptional activity by NF- κ B described here may also apply to other hormone nuclear receptors that are homologous with HNF-4 and bind to the same regulatory elements as HNF-4 but this hypothesis requires additional experimentation. If true, such a mechanism may have wide implications for nuclear receptor physiology.

ACKNOWLEDGEMENTS

We are grateful to Drs C. Stournaras, G. Mavrothalassitis, A. Eliopoulos, C. Tsatsanis (University of Crete), I. Talianidis (IMBB-FORTH, Heraklion), A. Gafencu (ICBP "N. Simionescu", Bucharest) and M. Hadzopoulou-Cladaras (Aristotelian University of Thessaloniki) for reagents, protocols and discussions. We thank Dr G. Koutsodontis for assistance in the chromatin immunoprecipitation experiment. This research was supported by a grant from the Greek Ministry of Development (PENED-2001) and internal funds from the Institute of Molecular Biology and Biotechnology of Crete.

References

1. Mangelsdorf, D.J., Thummel, C., Beato, M., Herrlich, P., Schutz, G., Umesono, K., Blumberg, B., Kastner, P., Mark, M., Chambon, P., and Evans, R.M. (1995) The nuclear receptor superfamily: the second decade. *Cell*. **83**, 835-9.
2. Sladek, F. M., and Seidel, S. D. (2001) in *Nuclear Receptors and Genetic Disease* (Burris, T.P., and McCabe, E., eds) pp. 309–361, Academic Press, San Francisco, CA
3. Giguere, V. (1999) Orphan Nuclear Receptors: From Gene to Function *Endocr. Rev.* **20**, 689–725
4. Hadzopoulou-Cladaras, M., Kistanova, E., Evagelopoulou, C., Zeng, S., Cladaras, C., and Ladias, J. (1997) Functional Domains of the Nuclear Receptor Hepatocyte Nuclear Factor 4 *J. Biol. Chem.* **272**, 539-550
5. Duda, K., Chi, Y. I., and Shoelson, S. E. (2004) Structural Basis for HNF-4 α Activation by Ligand and Coactivator Binding *J. Biol. Chem.* **279**, 23311–23316
6. Dhe-Paganon, S., Duda, K., Iwamoto, M., Chi, Y.-I., and Shoelson, S. E. (2002) Crystal Structure of the HNF-4 α Ligand Binding Domain in Complex with Endogenous Fatty Acid Ligand *J. Biol. Chem.* **277**, 37973-37976
7. Wisely, B. G., Miller, A. B., Davis, R. G., Thornquest, A. D., Johnson, R., Spitzer, T., Sefler, A., Shearer, B., Moore, J. T., Miller, A. B., Wilson, T. M., and Williams, S. P. (2002) Hepatocyte nuclear factor 4 is a transcription factor that constitutively binds fatty acids *Structure* **10**, 1225–1234

8. Ruse, M.D. Jr, Privalsky, M.L. and Sladek, F.M. (2002) Competitive cofactor recruitment by orphan receptor hepatocyte nuclear factor 4 α 1: modulation by the F domain. *Mol Cell Biol.* **22**, 1626-38
9. Sladek, F. M., Ruse, M. D., Nepomuceno, L., Huang, S. M., and Stallcup, M. R. (1999) Modulation of transcriptional activation and coactivator interaction by a splicing variation in the F domain of nuclear receptor hepatocyte nuclear factor 4 α 1. *Mol. Cel. Biol.* **19**, 6509–652.
10. Wang, J. C., Stafford, M. J., and Granner, D. K. (1998) SRC-1 and GRIP1 coactivate transcription with hepatocyte nuclear factor 4 *J. Biol. Chem.* **273**, 30847–30850.
11. Iordanidou, P., Aggelidou, E., Demetriades, C. and Hadzopoulou-Cladaras, M. (2005) Distinct amino acid residues may be involved in coactivator and ligand interactions in hepatocyte nuclear factor-4 α . *J. Biol. Chem.* **280**, 21810-21819
12. Dell, H., and Hadzopoulou-Cladaras, M. (1999) CREB-binding Protein Is a Transcriptional Coactivator for Hepatocyte Nuclear Factor-4 and Enhances Apolipoprotein Gene Expression. *J. Biol. Chem.* **274**, 9013–9021
13. Soutoglou, E., Katrakili, N., and Talianidis, I. (2000) Acetylation regulates transcription factor activity at multiple levels *Mol. Cell* **5**, 745–751.
14. Yoon, J. C., Puigserver, P., Chen, G., Donovan, J., Wu, Z., Rhee, J., Adelmant, G., Stafford, J., Kahn, C. R., Granner, D. K., Newgard, C. B., and Spiegelman, B. M. (2001) Control of hepatic gluconeogenesis through the transcriptional coactivator PGC-1. *Nature.* **413**, 131–138

15. Hayhurst, G. P., Lee, Y. H., Lambert, G., Ward, J. M., and Gonzalez, F. J. (2001) Hepatocyte Nuclear Factor 4 α (Nuclear Receptor 2A1) Is Essential for Maintenance of Hepatic Gene Expression and Lipid Homeostasis *Mol. Cell. Biol.* **21**, 1393-1403
16. Herbert, P.N., Assmann, G., Gotto, A.M. Jr., and Fredrickson, D.S. (1982) in *The Metabolic Basis of Inherited Diseases* (Stanbury, J.B., Wyngaarden, J.B., Fredrickson, D.S., Goldstein, J.L., and Brown, M.S., eds.) pp. 589-651, McGraw-Hill, New York.
17. Brown, W.V., and Baginsky, M.L. (1972) Inhibition of lipoprotein lipase by an apoprotein of human very low density lipoprotein *Biochem. Biophys. Res. Commun.* **46**, 375-382.
18. Shelburne, F., Hanks, J., Meyers, W., and Quarfordt, S. (1980) Effect of apoproteins on hepatic uptake of triglyceride emulsions in the rat. *J. Clin. Invest.* **65**, 652-658.
19. Windler, E., Chao, X. and Havel, R.J. (1980) Regulation of the hepatic uptake of triglyceride-rich lipoproteins in the rat. Opposing effects of homologous apolipoprotein E and individual C apoproteins. *J. Biol. Chem.* **255**, 8303-8307.
20. Krauss, R.M., Herbert, P.M., Levy, R.I. and Fredrickson, D.S. (1973) Further observations on the activation and inhibition of lipoprotein lipase by apolipoproteins. *Circ. Res.* **33**, 403-411.

21. Ito, Y., Azrolan, N., O'Connell, A., Walsh, A., and Breslow, J.L. (1990) Hypertriglyceridemia as a result of human apo CIII gene expression in transgenic mice. *Science*. **249**, 790-793.
22. de Silva, H.V., Lauer, S.J., Wang, J., Simonet, W.S., Weisgraber, K.H., Mahley, R.W., and Taylor, J.M. (1994) Overexpression of human apolipoprotein C-III in transgenic mice results in an accumulation of apolipoprotein B48 remnants that is corrected by excess apolipoprotein E. *J. Biol. Chem.* **269**, 2324-2335.
23. Karathanasis, S.K. (1985) Apolipoprotein multigene family: tandem organization of human apolipoprotein AI, CIII, and AIV genes. *Proc Natl Acad Sci U S A.* **82**, 6374-6378.
24. Ogami, K., Hadzopoulou-Cladaras, M., Cladaras, C., and Zannis, V.I. (1990) Promoter elements and factors required for hepatic and intestinal transcription of the human ApoCIII gene. *J. Biol. Chem.* **265**, 9808-9815.
25. Talianidis, I., Tambakaki, A., Toursounova, J. and Zannis, V.I. (1995) Complex interactions between SP1 bound to multiple distal regulatory sites and HNF-4 bound to the proximal promoter lead to transcriptional activation of liver-specific human APOCIII gene. *Biochemistry.* **34**, 10298-10309.
26. Kardassis, D., Tzamelis, I., Hadzopoulou-Cladaras, M., Talianidis, I., and Zannis, V.I. (1997) Distal apolipoprotein C-III regulatory elements F to J act as a general modular enhancer for proximal promoters that contain hormone response elements. Synergism between hepatic nuclear factor-4 molecules bound to the

proximal promoter and distal enhancer sites. *Arterioscler. Thromb. Vasc. Biol.* **17**, 222-232.

27. Ladias, J.A.A., Hadzopoulou-Cladaras, M., Kardassis, D., Cardot, P., Cheng, J., Zannis, V.I. and Cladaras, C. (1992) Transcriptional regulation of human apolipoprotein genes ApoB, ApoCIII, and ApoAII by members of the steroid hormone receptor superfamily HNF-4, ARP-1, EAR-2, and EAR-3. *J. Biol. Chem.* **267**, 15849-15860.

28. Lavrentiadou, S.N., Hadzopoulou-Cladaras, M., Kardassis, D. and Zannis, V.I. (1999) Binding specificity and modulation of the human ApoCIII promoter activity by heterodimers of ligand-dependent nuclear receptors *Biochemistry.* **38**, 964-975

29. Lacorte, J.M., Ktistaki, E., Beigneux, A., Zannis, V.I., Chambaz, J. and Talianidis, I. (1997) Activation of CAAT enhancer-binding protein delta (C/EBPdelta) by interleukin-1 negatively influences apolipoprotein C-III expression. *J. Biol. Chem.* **272**, 23578-84.

30. Lacorte, J.M., Beigneux, A., Parant, M., and Chambaz, J. (1997) Repression of apoC-III gene expression by TNFalpha involves C/EBPdelta/NF-IL6beta via an IL-1 independent pathway. *FEBS Lett* **415**, 217-20.

31. Hadzopoulou-Cladaras, M., Lavrentiadou, S.N., Zannis, V.I. and Kardassis, D. (1998) Transactivation of the ApoCIII promoter by ATF-2 and repression by members of the Jun family. *Biochemistry.* **37**, 14078-87.

32. Koj, A. (1998) Termination of acute-phase response: role of some cytokines and anti-inflammatory drugs. *Gen Pharmacol.* **31**, 9-18.

33. Shull, M. M., Ormsby, I., Kier, A. B., Pawlowski, S., Diebold, R. J., Yin, M., Allen, R., Sidman, C., Proetzel, G., Calvin, D., Annunziata, N. and Doetschman, T. (1992) Targeted disruption of the mouse transforming growth factor-beta 1 gene results in multifocal inflammatory disease. *Nature* **359**, 693–699.
34. Moustakas, A., Souchelnytskyi, S., and Heldin, C.H. (2001). Smad regulation in TGF-beta signal transduction. *J. Cell Sci.* **114**, 4359-4369.
35. Massague, J. (1998). TGF-beta signal transduction. *Annu. Rev. Biochem.* **67**, 753-791.
36. ten Dijke, P., Hill, C.S. (2004) New insights into TGF-beta-Smad signalling. *Trends Biochem Sci.* **29**, 265-73.
37. Kardassis, D., Pardali, K. and Zannis, V.I. (2000) SMAD proteins transactivate the human ApoCIII promoter by interacting physically and functionally with hepatocyte nuclear factor 4. *J. Biol. Chem.* **275**, 41405-41414.
38. Chou, W.C., Pocola, V., Shiraishi, K., Valcourt, U., Moustakas, A., Hadzopoulou-Cladaras, M., Zannis, V.I. and Kardassis, D. (2003) Mechanism of a transcriptional cross talk between transforming growth factor-beta-regulated Smad3 and Smad4 proteins and orphan nuclear receptor hepatocyte nuclear factor-4. *Mol Biol Cell.* **14**, 1279-94.
39. Prokova, V., Mosialos, G. and Kardassis, D. (2002) Inhibition of transforming growth factor beta signaling and Smad-dependent activation of transcription by the Latent Membrane Protein 1 of Epstein-Barr virus. *J Biol Chem.* **277**, 9342-9350.

40. Ktistaki, E., Lacorte, J.M., Katrakili, N., Zannis, V.I. and Talianidis, I. (1994) Transcriptional regulation of the apolipoprotein A-IV gene involves synergism between a proximal orphan receptor response element and a distant enhancer located in the upstream promoter region of the apolipoprotein C-III gene. *Nucleic Acids Res.* **22**, 4689-4696.
41. Vorgia, P., Zannis, V.I. and Kardassis, D. (1998) A short proximal promoter and the distal hepatic control region-1 (HCR-1) contribute to the liver specificity of the human apolipoprotein C-II gene. Hepatic enhancement by HCR-1 requires two proximal hormone response elements which have different binding specificities for orphan receptors HNF-4, ARP-1, and EAR-2. *J Biol Chem.* **273**, 4188-4196.
42. Koutsodontis, G. and Kardassis, D. (2004) Inhibition of p53-mediated transcriptional responses by mithramycin A. *Oncogene.* **23**, 9190-200
43. Koutsodontis, G., Moustakas, A. and Kardassis, D. (2002) The role of Sp1 family members, the proximal GC-rich motifs, and the upstream enhancer region in the regulation of the human cell cycle inhibitor p21WAF-1/Cip1 gene promoter. *Biochemistry.* **41**, 12771-12784.
44. Hatzivassiliou, E. and Mosialos, G. (2002) Cellular signaling pathways engaged by the Epstein-Barr virus transforming protein LMP1. *Front Biosci.* **7**, d319-329
45. Schiller, M., Javelaud, D. and Mauviel, A. (2004) TGF-beta-induced SMAD signaling and gene regulation: consequences for extracellular matrix remodeling and wound healing. *J Dermatol Sci.* **35**, 83-92.

46. Verrecchia, F., Wagner, E.F. and Mauviel, A. (2002) Distinct involvement of the Jun-N-terminal kinase and NF-kappaB pathways in the repression of the human COL1A2 gene by TNF-alpha. *EMBO Rep.* **3**, 1069-1074
47. Kan, H-Y., Georgopoulos, S. and Zannis, V. I. (2000) A hormone response element in the human apolipoprotein CIII (ApoCIII) enhancer is essential for intestinal expression of the ApoA-I and ApoCIII genes and contributes to the hepatic expression of the two linked genes in transgenic mice. *J Biol Chem.* **275**, 30423-30431.
48. Lee, Y.K., Dell, H., Dowhan, D.H., Hadzopoulou-Cladaras, M. and Moore, D.D. (2000) The orphan nuclear receptor SHP inhibits hepatocyte nuclear factor 4 and retinoid X receptor transactivation: two mechanisms for repression. *Mol Cell Biol.* **20**, 187-195.
49. De Fabiani, E., Mitro, N., Anzulovich, A.C., Pinelli, A., Galli, G. and Crestani, M. (2001) The negative effects of bile acids and tumor necrosis factor-alpha on the transcription of cholesterol 7alpha-hydroxylase gene (CYP7A1) converge to hepatic nuclear factor-4: a novel mechanism of feedback regulation of bile acid synthesis mediated by nuclear receptors. *J Biol Chem.* **276**, 30708-16.
50. Li, X., Salisbury-Rowswell, J., Murdock, A.D., Forse, R.A. and Burke, P.A. (2002) Hepatocyte nuclear factor 4 response to injury involves a rapid decrease in DNA binding and transactivation via a JAK2 signal transduction pathway. *Biochem J.* **368**, 203-11.

LEGENDS TO FIGURES

Figure 1: Antagonistic effects of pro- and anti-inflammatory cytokines on the activity of the human APOC3 promoter in HepG2 cells. *Panel A*, Human hepatoma HepG2 cells were transiently transfected with the APOC3 (-890/+24)-Luc reporter plasmid (2 μ g) and treated with different doses of human recombinant TNF α (0, 250, 500 and 1,000 units) for 24 hr. Cell extracts were analyzed for luciferase activity. Normalized, relative APOC3 promoter activity is shown with a bar graph. *Panel B*, HepG2 cells were transiently transfected with the APOC3 (-890/+24)-Luc reporter plasmid (2 μ g) and treated with TNF α (1,000 units) in the absence or in the presence of increasing doses of human recombinant TGF β 1 (0, 40 and 80 pM) for 24 hr. Cell extracts were analyzed for luciferase activity. Normalized, relative APOC3 promoter activity is shown with a bar graph. *Panel C*, HepG2 cells were transiently transfected with the APOC3 (-890/+24)-Luc reporter plasmid (2 μ g) along with increasing concentrations of expression vectors for human Smad3 and Smad4 (0, 0.5, 1.0, 1.5 and 2.0 μ g) and treated with a constant dose of TNF α (1,000 units) for 24 hr. Cell extracts were analyzed for luciferase activity. Normalized, relative APOC3 promoter activity is shown with a bar graph. *Panel D*, HepG2 cells were treated with TNF α (1,000 units) in the absence or in the presence of increasing doses of human recombinant TGF β 1 (0, 40 and 80 pM) for 24 hr. The expression of the APOC3 gene was analyzed by reverse transcription PCR. The expression levels of β tubulin were used for normalization of RNA concentration in the various samples.

Panel E, Schematic representation of the human APOA1/APOC3/APOA4 gene cluster and factors that regulate the expression of the APOC3 gene in a positive (+) or a negative (-) manner. The arrows show the direction of transcription of each gene and the grey boxes represent the promoter regions of the three genes of the cluster.

Figure 2: Inhibition of APOC3 promoter activity by TNF α is mediated by NF- κ B. **Panel A**, TNF α activates NF- κ B in HepG2 cells. HepG2 cells were serum starved for 16 hr and treated with TNF α (1,000 units) for 4 hr or left untreated. The intracellular distribution of the p65 subunit of NF- κ B was examined by indirect immunofluorescence using an anti-p65 antibody followed by a secondary FITC-conjugated antibody. Nuclei were stained with DAPI. **Panel B**, TNF α activates the MEK1/ERK pathway in HepG2 cells. HepG2 cells were pre-treated with the MEK1 inhibitor U0126 (10 μ M) for 24 hr followed by a short treatment with TNF α (1,000 units) for 15 min. Cell extracts were analyzed by Western blotting for phospho-ERK or total ERK using the corresponding anti-ERK antibodies followed by secondary HRP-conjugated antibodies. Arrows show the position of pERK and ERK1,2 proteins. **Panel C**, HepG2 cells were transiently transfected with the APOC3 (-890/+24)-Luc reporter plasmid (2 μ g) and treated with TNF α (1000 units) in the presence or in the absence of an expression vector for the non-degradable form of I κ B α I κ B-ND (2.0 μ g) or the MEK1 inhibitor U0126 (10 μ M) for 24 hr. Cell extracts were analyzed for luciferase activity. Normalized, relative APOC3 promoter activity is shown with a bar graph. **Panel D**, HepG2 cells were transiently transfected with the APOC3 (-890/+24)-Luc reporter

plasmid (2 μ g) along with increasing concentrations of an expression vector for IKK β (0, 1.0 and 2.0 μ g). Cell extracts were analyzed for luciferase activity. Normalized, relative APOC3 promoter activity is shown with a bar graph. **Panel E**, HepG2 cells were transiently transfected with the APOC3 (-890/+24)-Luc reporter plasmid (2 μ g) along with expression vectors for p65, p50 or a p50-p65 hybrid protein (2.0 μ g each). Cell extracts were analyzed for luciferase activity. Normalized, relative APOC3 promoter activity is shown with a bar graph. **Panel F**, HepG2 cells were transiently transfected with the (NF- κ B)₃-Luc reporter plasmid (2 μ g) along with an expression vector for LMP1 (25 ng) in the presence or in the absence of an expression vector for I κ B-ND (2.0 μ g). Cell extracts were analyzed for luciferase activity. Normalized, relative APOC3 promoter activity is shown with a bar graph. **Panel G**, HepG2 cells were transiently transfected with the APOC3 (-890/+24)-Luc reporter plasmid (2 μ g) along with increasing concentrations of an expression vector for LMP1 (0, 5, 10 and 25 ng). Cell extracts were analyzed for luciferase activity. Normalized, relative APOC3 promoter activity is shown with a bar graph.

Figure 3: The proximal Hormone Response Element of the APOC3 promoter is sufficient to mediate inhibition by TNF α **Panel A**, Schematic representation of the APOC3 promoter-Luciferase constructs used in the transactivation experiments of Panel B. Regulatory elements in the APOC3 proximal promoter and the enhancer are shown by boxes labeled B-J. HRE: Hormone Response Element. **Panel B**, HepG2 cells were transiently transfected with the various APOC3-Luc reporter plasmid (2 μ g) shown at the bottom of the

graph and were treated with $\text{TNF}\alpha$ (1000 units) for 24 hr or cotransfected with an expression vector for LMP1 (25 ng). Cell extracts were analyzed for luciferase activity. Normalized, relative APOC3 promoter activity is shown with a bar graph.

Figure 4: $\text{TNF}\alpha$ inhibits the HNF-4-mediated transactivation of the APOC3 and APOC2 promoters.

Panel A, Schematic representation of the human APOC3, APOC2 and APOA4 promoter regions showing the locations of the Hormone Response Elements that bind HNF-4 in each promoter. The location of the oligonucleotide primer sets on the APOC3 promoter that were utilized in the chromatin immunoprecipitation assays of Panel B are shown by arrows labelled D1,D2 (distal primers) and P1,P2 (proximal primers). **Panel B**, Recruitment of HNF-4 to the proximal APOC3 promoter *in vivo*. The chromatin immunoprecipitation assay was performed using chromatin from HepG2 cells as described in "Materials and Methods" using primers corresponding to the proximal (P1,P2) or the distal (D1,D2) regions of the APOC3 promoter in the absence (second lane) or in the presence (third lane) of an anti-HNF-4 antibody. Non-immunoprecipitated chromatin was included as a positive control (first lane labeled "input"). **Panels C and D**, HepG2 cells were transiently transfected with the APOC3 (-890/+24)-Luc reporter plasmid (2 μg) (Panel C) or with the APOC2 (-550/+18)-Luc plasmid (2 μg) (Panel D) and were treated with $\text{TNF}\alpha$ (1,000 units) for 24 hr or were cotransfected with an expression vector for LMP1 (25 ng). The same experiment was repeated in the presence of an expression vector for HNF-4 (2 μg). Cell extracts were analyzed for luciferase activity. Normalized, relative promoter activity is shown with a bar graph. **Panel E**, HEK-293T cells

were transiently transfected with the APOC3 (-890/+24)-Luc reporter plasmid or with the APOA4 (-700/+24)-Luc plasmid (2 μ g) and were treated with TNF α (1,000 units) for 24 hr or cotransfected with an expression vector for LMP1 (25 ng). The same experiment was repeated in the presence of an expression vector for HNF-4 (2 μ g). Cell extracts were analyzed for luciferase activity. Normalized, relative promoter activity is shown with a bar graph.

Figure 5: TNF α does not affect the nuclear localization or the stability but inhibits the DNA binding activity of HNF-4. *Panel A*, HepG2 cells were plated in coverslips and treated with TNF α (1,000 units) for 24 hr or left untreated. The intracellular localization of HNF-4 was observed by indirect immunofluorescence using an anti-HNF-4 polyclonal antibody followed by a secondary, FITC-conjugated antibody. *Panel B*, HEK-293T cells were transiently co-transfected with expression vectors for HNF-4 and FLAG-LMP1 and placed in coverslips. The intracellular localization of HNF-4 and FLAG-LMP1 proteins was observed by indirect immunofluorescence using an anti-HNF-4 polyclonal antibody and an anti-FLAG mouse monoclonal antibody followed by the appropriate secondary, FITC- or rhodamin-conjugated, antibodies. In panels A and B, cells were observed using a Leica SP confocal fluorescent microscope. *Panel C*, HepG2 cells were treated with TNF α (1,000 units) for 24 hr or left untreated. The levels of expression of endogenous HNF-4 protein was determined by Western blotting using an anti-HNF-4 goat polyclonal antibody followed by a secondary, HRP-conjugated antibody. *Panel D*, HEK-293T cells were transiently transfected with an expression vector for HNF-4 and were treated with TNF α (1,000 units) for 24

hr or cotransfected with an expression vector for FLAG-LMP1. The levels of expression of exogenous HNF-4, FLAG-LMP1 and tubulin (control) in the transfected cells was determined by Western blotting using an anti-HNF-4 goat polyclonal antibody, an anti-FLAG mouse monoclonal antibody and a mouse monoclonal anti- β -tubulin antibody respectively followed by the appropriate secondary, HRP-conjugated, antibodies. **Panel E**, DNA Affinity Precipitation (DNAP) experiment using nuclear extracts from HepG2 cells that had been treated with TNF α (1,000u) for 24h or from untreated HepG2 cells and biotinylated oligonucleotides corresponding to the -92/-67 region of the human APOC3 promoter or the -86/-70 region of the human p21^{Cip1} promoter. HNF-4 bound to the oligonucleotides was detected by SDS-PAGE and immunoblotting using a polyclonal anti-HNF-4 antibody

Figure 6: Different effectors of the NF- κ B pathway inhibit the transcriptional activation function of HNF-4 in a GAL4-based transactivation system. **Panel A**, Schematic representation of GAL4-HNF-4 (1-455) protein that was utilized in the transactivation experiments of Panels B-D. Functional domains in HNF-4 are shown by the letters A-F. AF: Activation Function. DBD: DNA Binding Domain. **Panel B**, HepG2 cells were transiently transfected with the pG5B-Luc reporter plasmid (2 μ g) along with an expression vector for GAL4-HNF-4 (1-455) (100 ng) and were treated with TNF α (1000 units) or the MEK1 inhibitor U0126 for 24 hr as shown at the bottom of the graph. The dominant negative form of I κ B (I κ B-ND) (2 μ g) was also utilized in one of the assays along with TNF α . Cell extracts were analyzed for luciferase activity. Normalized, relative promoter activity is

shown with a bar graph. **Panel C**, HepG2 cells were transiently transfected with the pG5B-Luc reporter plasmid (2 μ g) along with an expression vector for GAL4-HNF-4 (1-455) (100 ng) in the absence or in the presence of expression vectors for LMP1 (25 ng), NIK (2 μ g), IKK β (2 μ g) and p65 (2 μ g) as shown at the bottom of the graph. Cell extracts were analyzed for luciferase activity. Normalized, relative promoter activity is shown with a bar graph. **Panel D**, HepG2 cells were transiently transfected with the pG5B-Luc reporter plasmid (2 μ g) along with an expression vector for GAL4-HNF-4 (1-455) (100 ng) in the absence or in the presence of expression vectors for Smad3, Smad4 and p65 (2 μ g) as indicated at the bottom of the graph. Cell extracts were analyzed for luciferase activity. Normalized, relative promoter activity is shown with a bar graph.

Figure 7: Both transactivation domains of HNF-4 (AF1 and AF2) are inhibited by TNF α and the NF- κ B pathway. **Panel A**, Schematic representation of the various truncated GAL4-HNF-4 proteins that were utilized in the transactivation experiments of Panels B-D. Symbols are as in Fig. 7A. **Panel B**, HepG2 cells were transiently transfected with the pG5B-Luc reporter plasmid (2 μ g) along with expression vectors for GAL4-HNF-4 (1-174) or GAL4-HNF-4 (1-49) (100 ng) and were treated with TNF α (1,000 units) for 24 hr or left untreated as shown at the bottom of the graph. Cell extracts were analyzed for luciferase activity. Normalized, relative promoter activity is shown with a bar graph. **Panel C**, HepG2 cells were transiently transfected with the pG5B-Luc reporter plasmid (2 μ g) along with expression vectors for GAL4-HNF-4 (1-174) or GAL4-HNF-4 (1-49) (100 ng) in the absence or in the presence of expression vectors for LMP1

(25 ng) or p65 (2 μ g) as shown at the bottom of the graph. Cell extracts were analyzed for luciferase activity. Normalized, relative promoter activity is shown with a bar graph. **Panel D**, HepG2 cells were transiently transfected with the pG5B-Luc reporter plasmid (2 μ g) along with expression vectors for GAL4-HNF-4 (48-455) or GAL4-HNF-4 (175-370) (100 ng) and were treated with TNF α (1,000 units) for 24 hr or left untreated as shown at the bottom of the graph. Cell extracts were analyzed for luciferase activity. Normalized, relative promoter activity is shown with a bar graph.

Figure 8: Inhibition of HNF-4 activity by TNF α may be accounted for by interference with the recruitment or the functions of AF-1 and AF-2 HNF-4 coactivators. **Panel A**, HepG2 cells were transiently transfected with the pG5B-Luc reporter plasmid (2 μ g) along with an expression vector for GAL4-HNF-4 (100 ng) and were treated with TNF α (1,000 units) for 24 hr in the absence or in the presence of expression vectors for the coactivators CBP, SRC3 (2 μ g each) and two different concentrations of the PGC-1 coactivator (1 and 2 μ g) as indicated at the bottom of the graph. Cell extracts were analyzed for luciferase activity. Normalized, relative promoter activity is shown with a bar graph. **Panel B**, HepG2 cells were transiently transfected with the pG5B-Luc reporter plasmid (2 μ g) along with expression vectors for GAL4-HNF-4 (100 ng), LMP1 (25 ng) and two different concentrations of an expression vector for PGC-1 (1 and 2 μ g). Cell extracts were analyzed for luciferase activity. Normalized, relative promoter activity is shown with a bar graph. **Panel C**, HepG2 cells were transiently transfected with the (NF- κ B)₃-Luc reporter plasmid (2 μ g) along with an

expression vectors for LMP1 (50 ng) and two different concentrations of an expression vector for PGC-1 (1 and 2 μ g). Cell extracts were analyzed for luciferase activity. Normalized, relative promoter activity is shown with a bar graph. **Panel D**, HepG2 cells were transiently transfected with the pG5B-Luc reporter plasmid (2 μ g) along with expression vectors for GAL4-HNF-4 (48-455) (100 ng), LMP1 (50 ng), PGC-1 (2 μ g) and CBP (2 μ g) as indicated at the bottom of the graph. Cell extracts were analyzed for luciferase activity. Normalized, relative promoter activity is shown with a bar graph. **Panel E**, HepG2 cells were transiently transfected with the pG5B-Luc reporter plasmid (2 μ g) along with expression vectors for GAL4-HNF-4 (1-49) (100 ng), LMP1 (50 ng), PGC-1 (2 μ g) and CBP (2 μ g) as indicated at the bottom of the graph. Cell extracts were analyzed for luciferase activity. Normalized, relative promoter activity is shown with a bar graph.

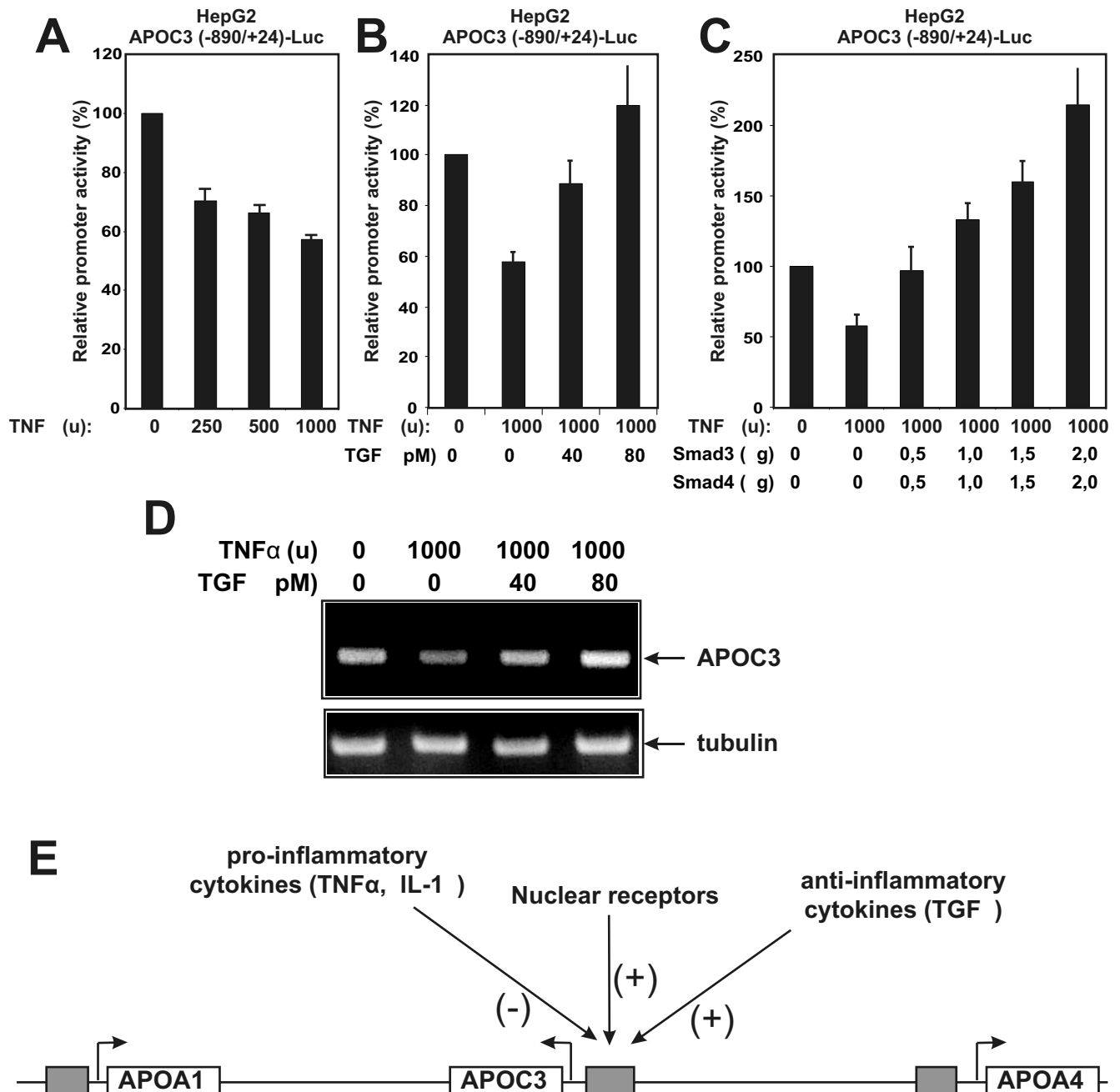

Figure 1, Nikolaidou-Neokosmidou et al.

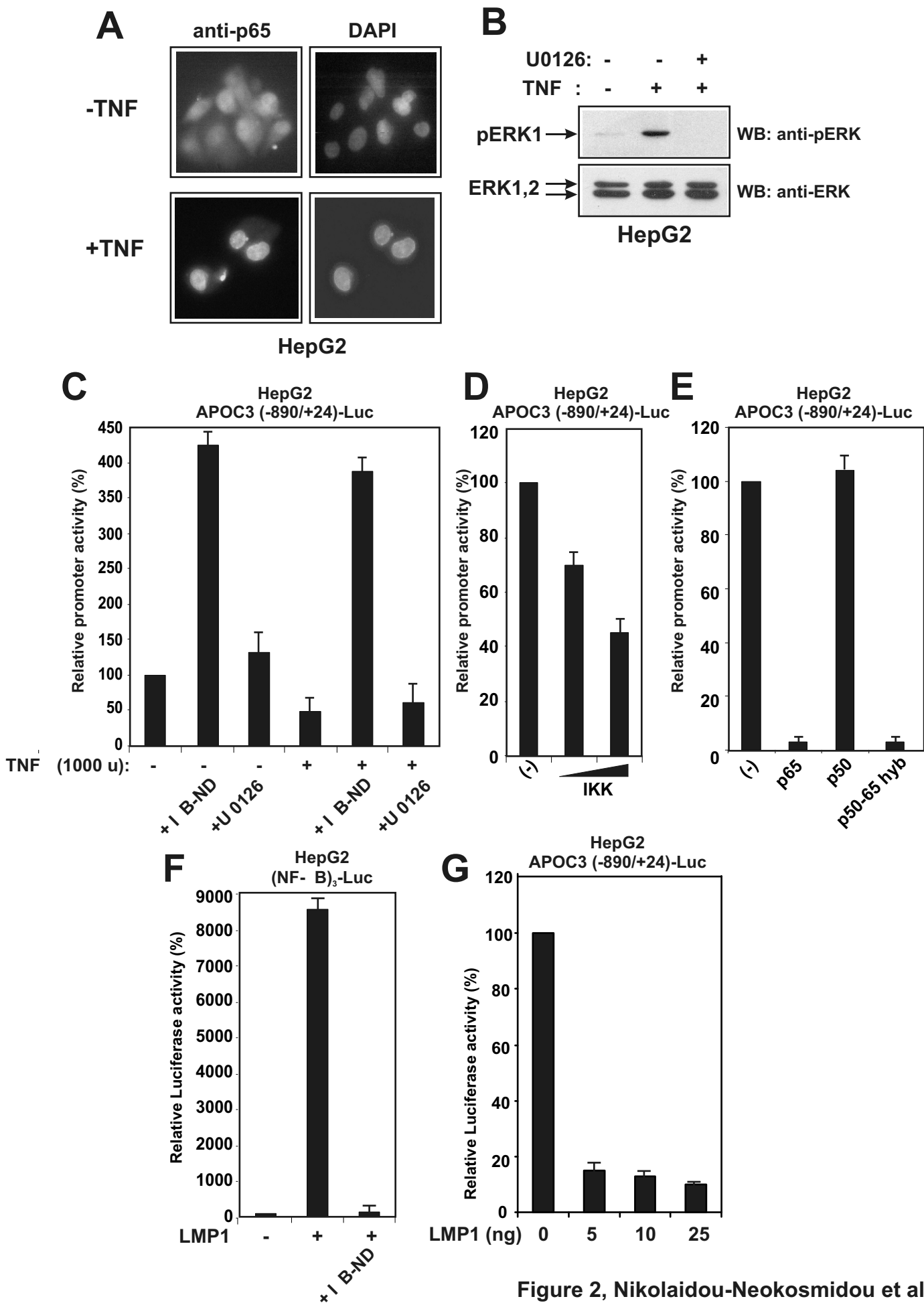

Figure 2, Nikolaidou-Neokosmidou et al.

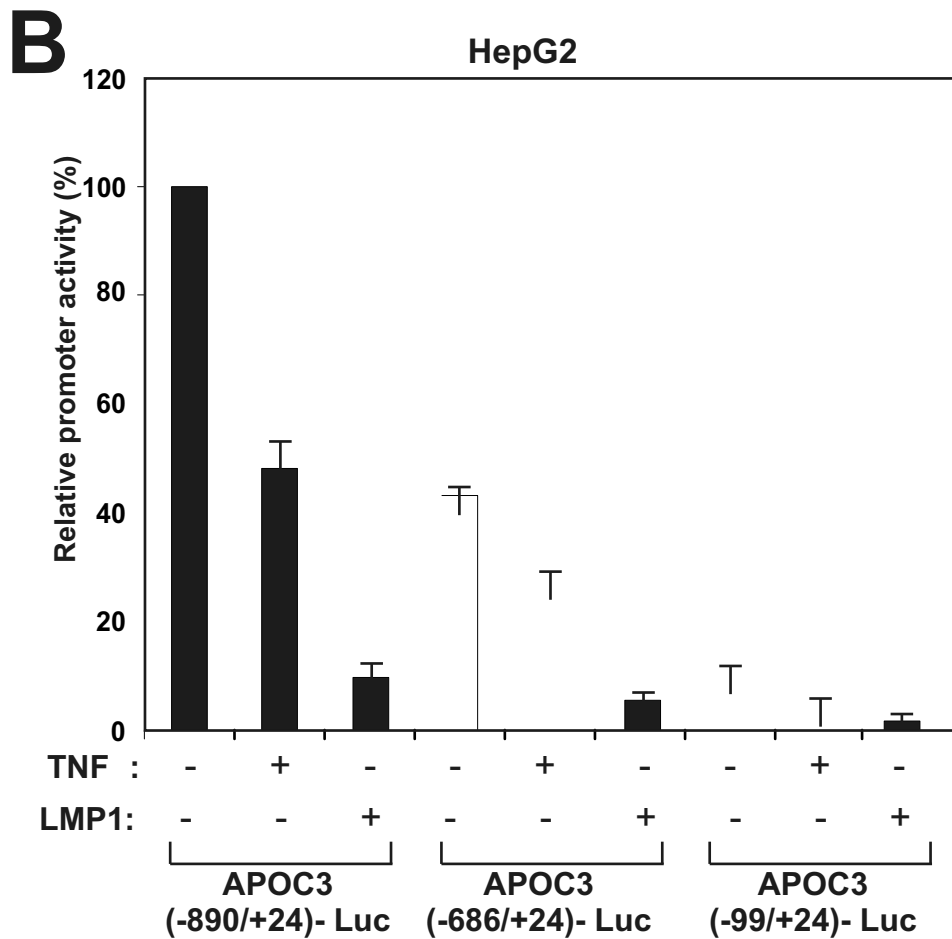
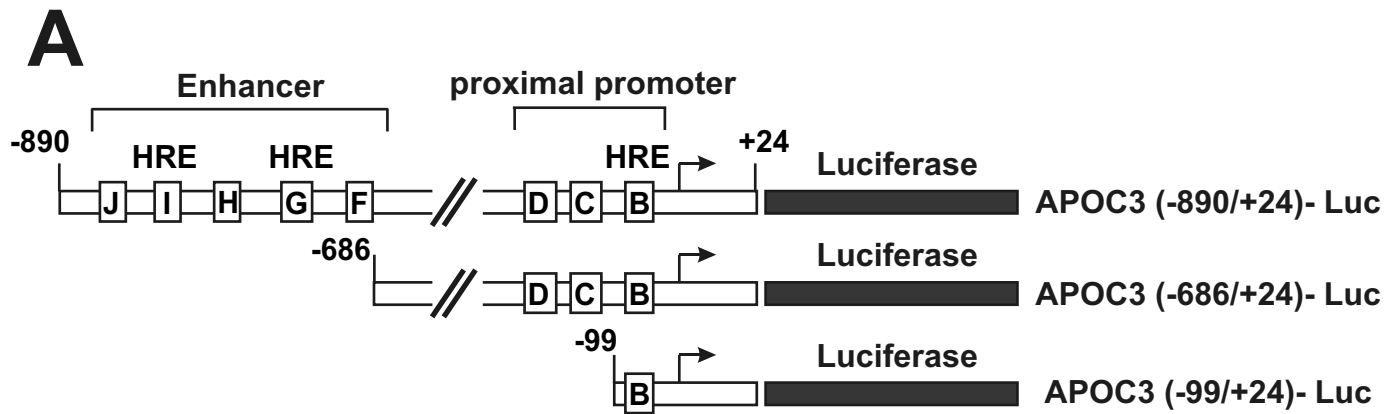

Figure 3, Nikolaidou-Neokosmidou et al.

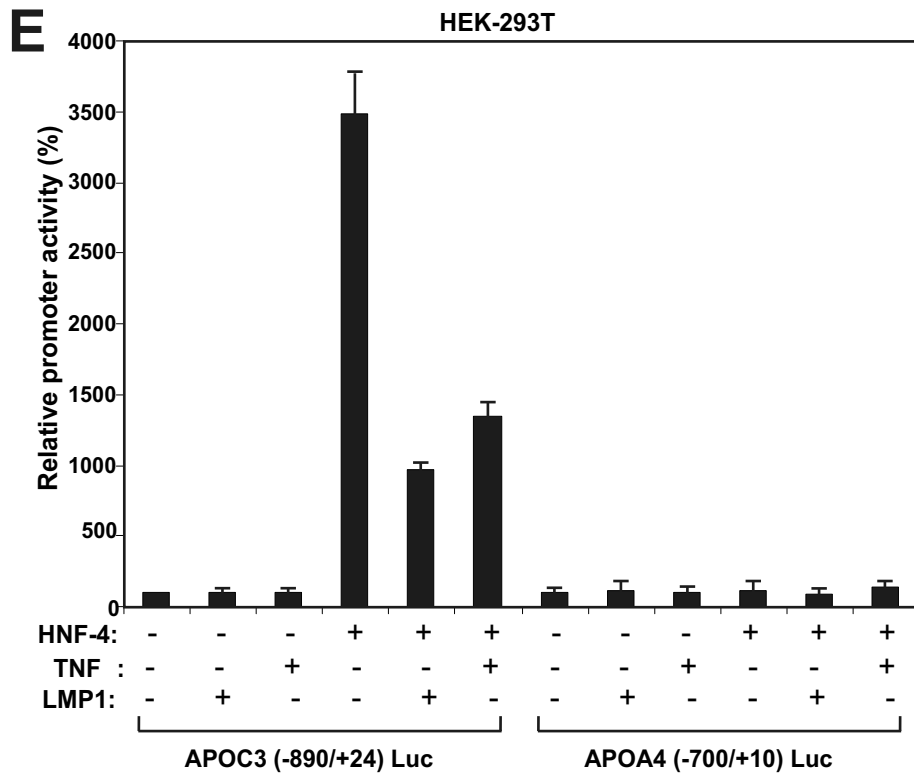
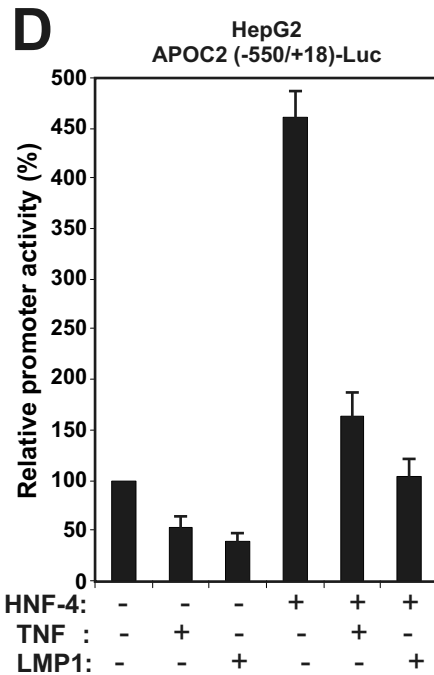
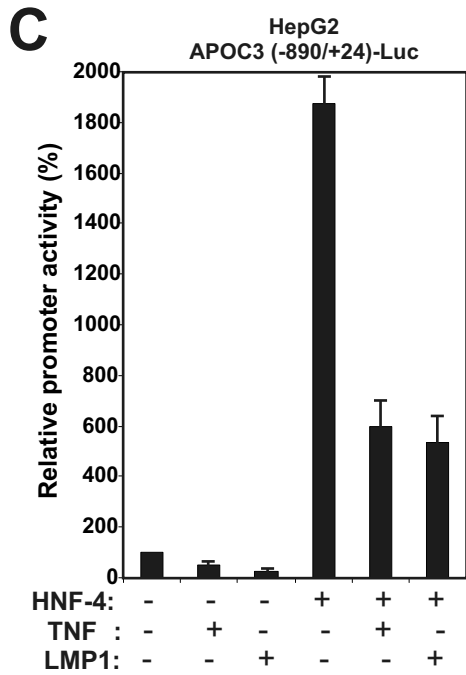
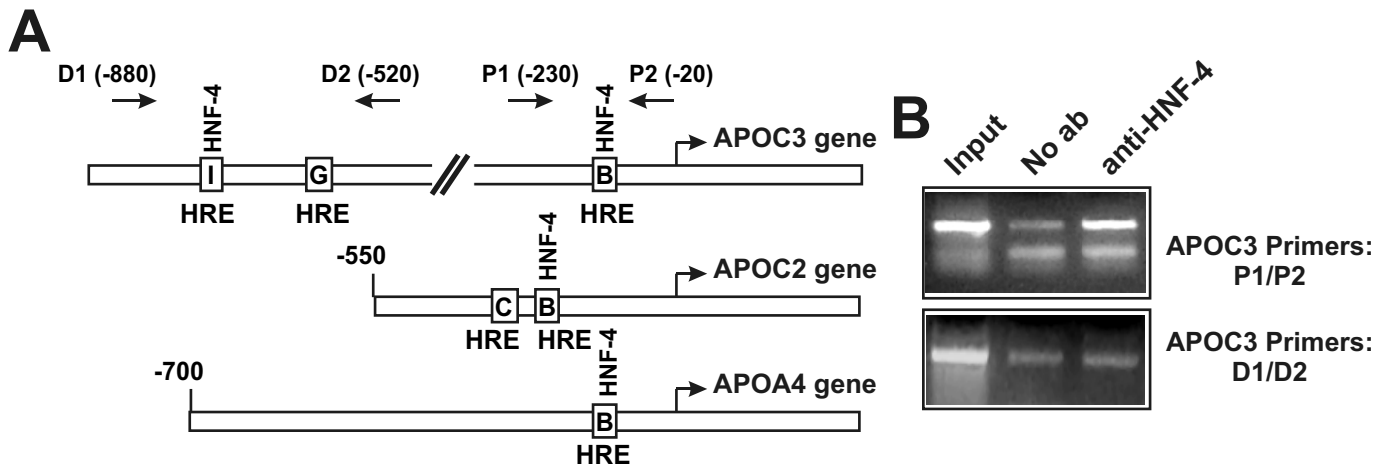

Figure 4, Nikolaidou-Neokosmidou et al.

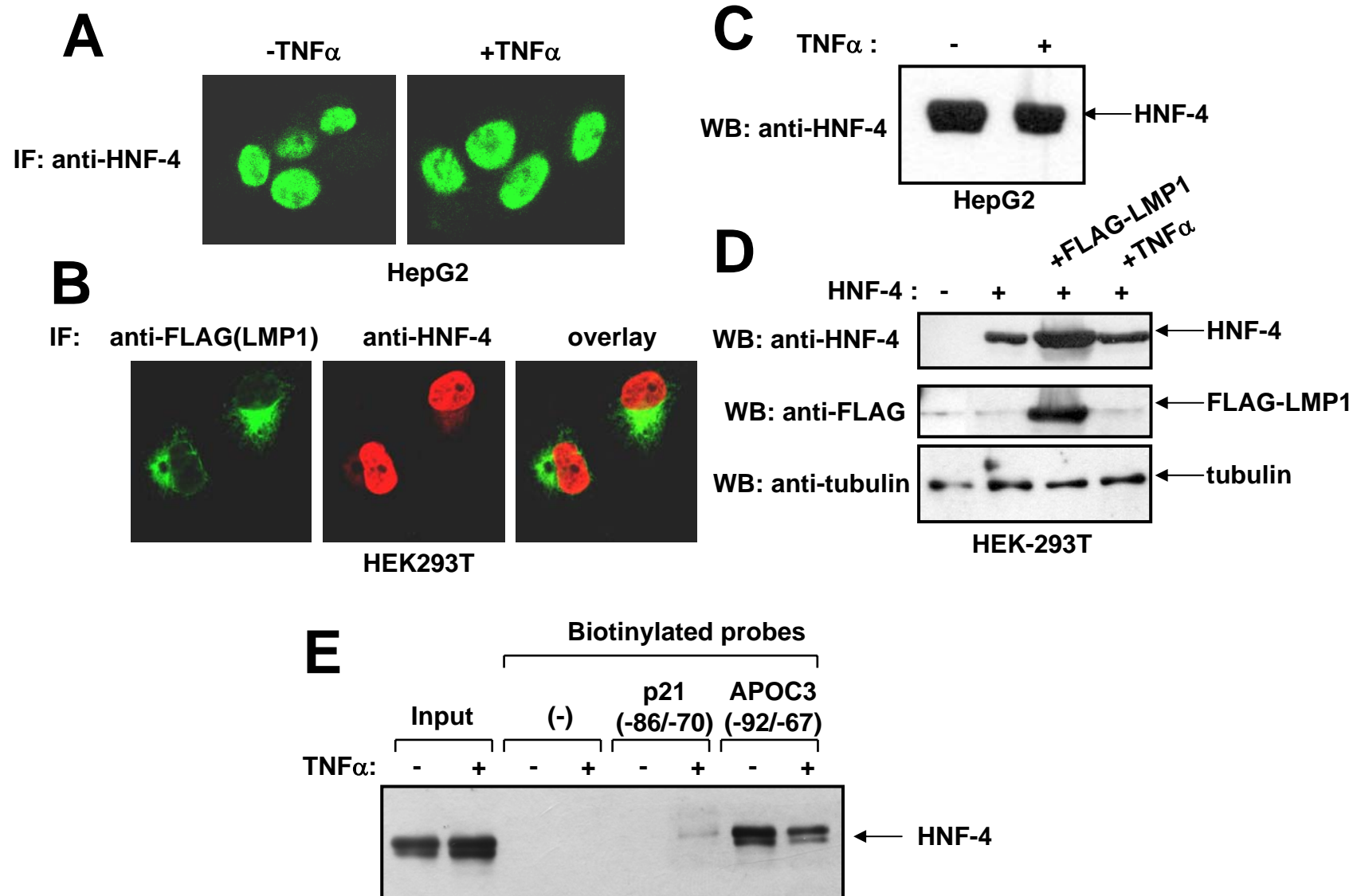

Figure 5, Nikolaidou-Neokosmidou et al

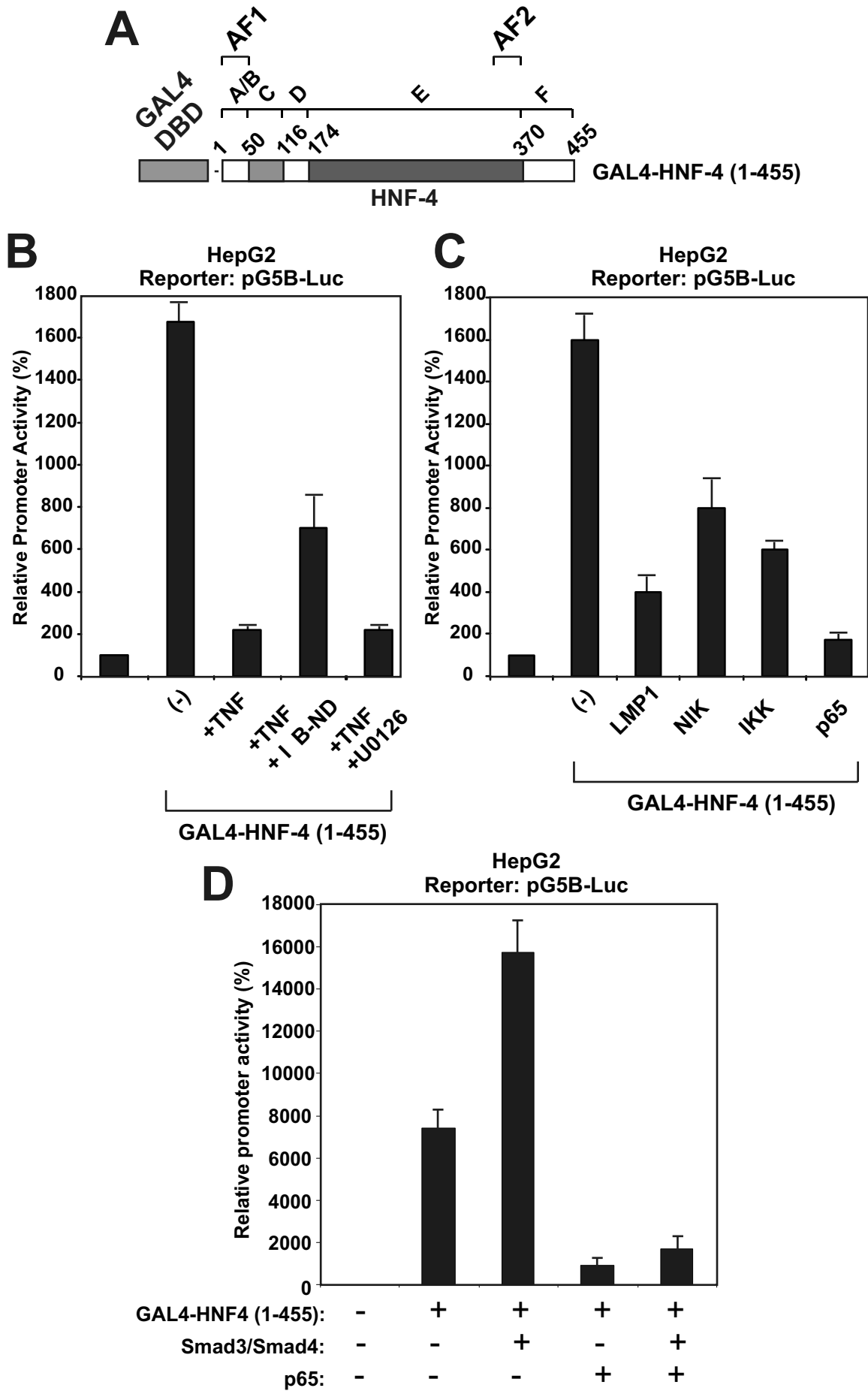

Figure 6, Nikolaidou-Neokosmidou et al.

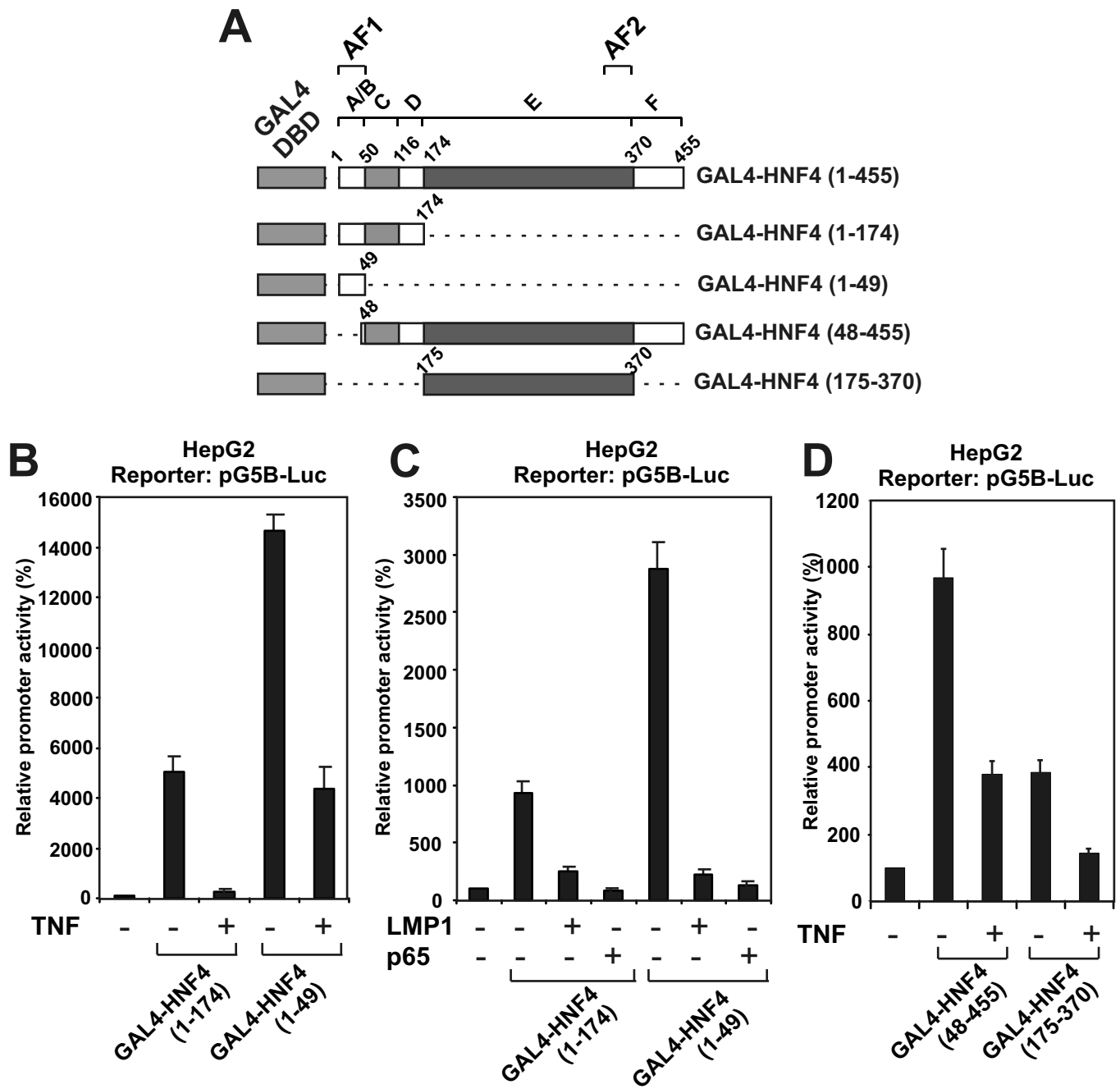

Figure 7, Nikolaidou-Neokosmidou et al.

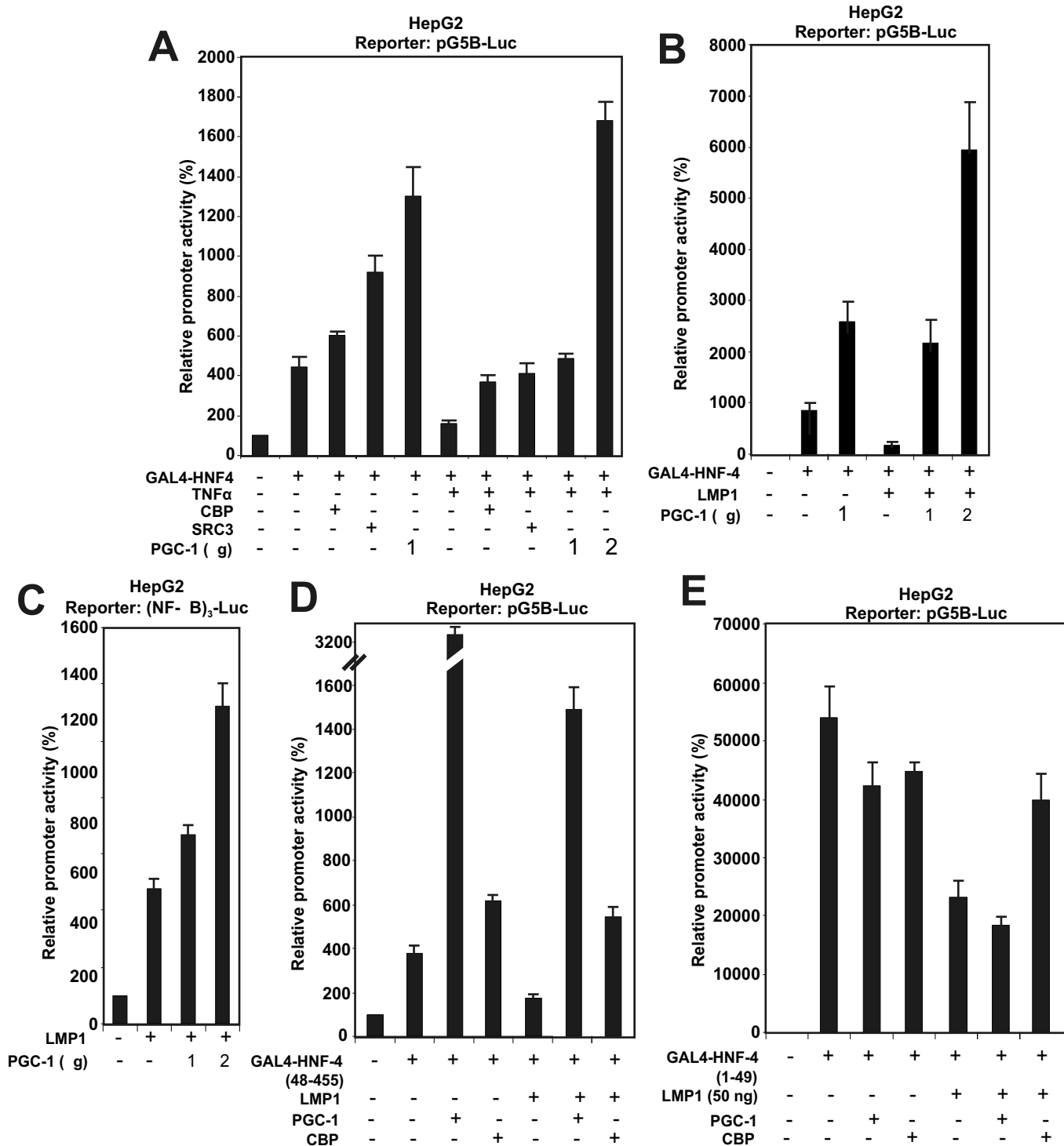

Figure 8, Nikolaidou-Neokosmidou et al.