



HAL
open science

Modelling and experimental validation of a fluidized bed reactor freeboard region: application to natural gas combustion

Salah Dounit, Mehrdji Hemati, Régis Andreux

► **To cite this version:**

Salah Dounit, Mehrdji Hemati, Régis Andreux. Modelling and experimental validation of a fluidized bed reactor freeboard region: application to natural gas combustion. Chemical Engineering Journal, 2007, vol. 140 n°1-3., 457-465 available on : http://oatao.univ-toulouse.fr/550/1/andreux_550.pdf. 10.1016/j.cej.2007.11.033 . hal-00476954

HAL Id: hal-00476954

<https://hal.science/hal-00476954>

Submitted on 26 Mar 2024

HAL is a multi-disciplinary open access archive for the deposit and dissemination of scientific research documents, whether they are published or not. The documents may come from teaching and research institutions in France or abroad, or from public or private research centers.

L'archive ouverte pluridisciplinaire **HAL**, est destinée au dépôt et à la diffusion de documents scientifiques de niveau recherche, publiés ou non, émanant des établissements d'enseignement et de recherche français ou étrangers, des laboratoires publics ou privés.

1 **MODELLING AND EXPERIMENTAL VALIDATION OF**
2 **A FLUIDIZED BED REACTOR FREEBOARD REGION:**
3 **APPLICATION TO NATURAL GAS COMBUSTION.**

4
5 S. DOUNIT , M. HEMATI * , R. ANDREUX
6 Laboratoire de Génie Chimique, U.M.R 5503, ENSIACET,
7 05 rue Paulin Talabot, 31106 Toulouse - France.
8
9

10 **ABSTRACT**

11 A theoretical and experimental study of natural gas-air mixture combustion in a
12 fluidized bed of sand particles is presented. The operating temperatures are lower than a
13 critical temperature of 800 °C above which the combustion occurs in the vicinity of the
14 fluidized bed. Our study focusses on the freeboard zone where most of the methane
15 combustion takes place at such temperatures. Experimental results show the essential role of
16 the projection zone in determining the global thermal efficiency of the reactor. The dense bed
17 temperature, the fluidizing velocity and the mean particle diameter significantly affect the
18 thermal behaviours.

19 A model for natural gas-air mixture combustion in fluidized beds is proposed,
20 counting for interactions between dense and dilute regions of the reactor [Pré et al. (1998)]
21 supplemented with the freeboard region modelling of Kunii-Levenspiel (1990). Thermal
22 exchanges due to the convection between gas and particles, and due to the conduction and
23 radiation phenomena between the gas-particle suspension and the reactor walls are counted.
24 The kinetic scheme for the methane conversion is that proposed by Dryer and Glassman
25 (1973). Model predictions are in good agreement with the measurements.

26 **Keywords:** Fluidization, Combustion, Natural gas, Model, Freeboard

27 **I: INTRODUCTION.**

28 Fluidized bed combustors have many advantages, including their simplicity of
29 construction, their flexibility in accepting solid, liquid or gaseous fuel, and their high
30 combustion efficiency at low temperatures what minimises NO_x generation [Foka et al.

31 (1994)]. Fluidized bed natural gas combustors are used in many industrial applications such as
32 incineration of sludge with high moisture content or solid particles calcination. Given the
33 ecological benefit of using natural gas in fluidized bed furnaces, it is of interest to describe the
34 combustion process in fluidized beds using experimental and theoretical approaches.

35 Natural gas combustion mechanisms in fluidized beds have been widely investigated
36 at bed temperatures greater than a critical temperature close to 800 °C [Dounit et al. (2001),
37 Pré et al. (1998), Pré-Goubelle (1997), Van Der Vaart (1992), Yanata et al. (1975), Baskakov
38 and Makhorin (1975)], above which the methane conversion is fully realized in the dense
39 zone. Sadilov and Baskakov (1973) reported temperatures measured in the bubble eruption
40 zone above the bed surface greater than the theoretical flame temperature. At bed
41 temperatures lower than this critical temperature, the combustion of methane is mainly
42 realized in the freeboard zone. In such conditions, the methane bubble eruption in the lean
43 phase of the fluidized bed induces high exploding risks [Dounit et al. (2001)]. Thus, low
44 temperature reacting fluidized bed applications require experiments for safety reasons. In such
45 a way, hydrodynamics and thermal phenomena occurring in the freeboard region of fluidized
46 bed reactors must be investigated and modelled.

47 However, there is a lack of references in the literature on the experimental and
48 theoretical study of the reacting fluidized bed dilute region. Indeed, previous works were
49 either room temperature hydrodynamic studies [Wen and Chen (1982), Fournol et al. (1973),
50 Zenz and Weil (1958), Kunii and Levenspiel (1990), George and Grace (1978)] or isothermal
51 catalytic chemical studies.

52 In this paper, hydrodynamics and thermal phenomena coupling in the projection zone
53 of a fluidized bed operating in the bubbling regime is experimentally studied and modelled.
54 The natural gas combustion modelling proposed by Pré et al. (1998) is used to predict the
55 reactor dense region while the Kunii-Levenspiel modelling (1990) is used to describe the

56 freeboard region. The two-stage kinetic scheme of methane conversion proposed by Dryer
57 and Glassman (1973) is used. The resulting reactor model is validated using our experimental
58 data.

59 **II: DESCRIPTION OF THE SET-UP.**

60 The experimental set-up is given in Figure 1. The reactor consists of a heat resistant of
61 steel pipe 180 mm in diameter and 1400 mm high, with a disengaging section 360 mm in
62 diameter and 1000 mm high. The reactor is equipped with a perforated plate distributor of 1.8
63 % porosity. The bed temperature is controlled using cooling air flowing in a double shell. The
64 pneumatic valve what controls the air circuit feeding into the double shell is controlled by a
65 PID system equipped with a thermocouple located in the dense bed. Natural gas with 97 %
66 methane content is used as the combustibile and premixed to the air in the windbox. The
67 reactor is fitted axially with chromel-alumel-type temperature sensors and water-cooled tubes
68 to sample the gas located at 50, 100, 250, 300, 400, 450, 550, 600, 650, 700, 900, 1000, 1100,
69 1200 and 1300 mm above the distributor. The sampling tubes are connected to a pump, a
70 cooling unit to eliminate water, infrared-type analysers to measure CH_4 , CO_2 , and CO mole
71 fractions, and a paramagnetic-type analyser for O_2 measurements. Experiments safety is
72 ensured using (i) a burner placed in the wider section of the reactor what converts the
73 unburned gas exiting at the fluidized bed outlet (ii) a thermocouple placed in the windbox
74 connected to a PID regulator what cuts off the reactor feeding when the windbox temperature
75 reaches a critical value chosen well below the air-methane auto-burning temperature.

76 The studied operating conditions are presented in Table 1. Typical sand particles with
77 a density of 2650 kg.m^{-3} and mean size ranging between 100 and $550 \mu\text{m}$ are fluidized. The
78 air factor, defined as the ratio of the volume of air fed into the reactor to the required volume
79 for stoichiometric combustion of methane, ranges between 1.0 and 1.5. The bed temperature,

80 T_{bed} , is defined to that measured 150 mm above the distributor. The fluidizing velocity ranges
81 between 2 and 4 times the minimum fluidizing velocity at 20 °C.
82 (Table 1).

83 **III: EXPERIMENTAL RESULTS.**

84 **III.1: Typical experiment presentation.**

85 C1 experiments (Table 1) are realized in permanent regime, with a dense bed
86 temperature ranging between 650 and 800 °C.

87 **Temperature profiles.**

88 The differences between the local temperature measured along the reactor axis and the
89 dense bed temperature, T_{bed} , are presented in Figure 2. An increase in the local temperature
90 characterizes the combustion zone, what moves towards the bed surface when increasing the
91 dense bed temperature . The combustion mainly takes place in the bed dense region when
92 dense bed temperature is higher than 800°C, what is consistent with previous observations
93 reported in the literature [Dounit (2001), Pré et al. (1998), Pré-Goubelle (1997)]. The local
94 temperature decreasing above the combustion zone is attributed to heat losses.

95 **Pressure drop profiles.**

96 The effect of the dense bed temperature, T_{bed} , on the normalized standard deviation of
97 the pressure drop fluctuations, $\frac{\sigma}{\Delta P}$, measured at different heights is presented in Figure 3.
98 The methane combustion occurs close to the bed surface when the dense bed temperature,
99 T_{bed} , reaches the critical value of 800 °C, and the resulting exploding of methane bubbles
100 reaching the bed surface induces an increase in the local pressure fluctuations. When
101 increasing the bed temperature above the critical temperature, T_{bed} , the local pressure
102 fluctuations decrease again. Such observations have ever been reported by Baskakov and
103 Makhorin (1975).

104 **Reaction behaviour.**

105 The freeboard region plays an important role in the combustion behaviour, especially
106 when the dense bed temperature is lower than the critical value of 800 °C. At a dense bed
107 temperature, T_{bed} , of 700 °C, the major part of the methane conversion is realized in the
108 freeboard region 400 mm above the dense bed surface, as underlined by the mole fraction of
109 the stable species (CH_4 , O_2 , CO_2) measured along the reactor axis (Figure 4-a). The
110 progressive decreasing in the local methane mole fraction indicates that the natural gas
111 combustion process in the freeboard region of the reactor is a progressive process.

112 The bell shape of the CO mole fraction profile confirms the successive nature of the
113 methane combustion reaction with CO formation as an intermediate species (Figure 4-b). This
114 was already observed experimentally and modelled by several authors [Dryer and Glassman
115 (1973), Westbrook and Dryer (1981), Bradley et al. (1977)].

116 **III.2: Effect of operating conditions.**

117 The experiments are carried out at dense bed temperatures lower than the critical
118 temperature of 800 °C (Table 1). An increase in the excess air factor above 1.1 has little
119 influence on the process behaviour, both in the dense and dilute regions. The temperature and
120 the methane conversion profiles obtained at different excess air factors are very close to each
121 other (Dounit, 2001). On the other hand, an increase in the total mass of solids in the reactor
122 from 9 up to 15 kg has no significant effect on the reaction progress in the freeboard, since no
123 reaction occurs in the dense bed region at these low bed temperatures.

124 **Superficial gas velocity effect.**

125 Figures 5 and 6 present the temperature and the methane conversion measured along
126 the reactor axis at 700 °C. Three values of gas velocity are considered, respectively 2, 3 and 4
127 times U_{mf} at 20 °C, corresponding to gas velocities ranging between 10.5 and 26 times U_{mf}
128 at dense bed temperature. The combustion zone moves upwards from the bed level to the
129 outlet of the reactor when increasing the superficial gas velocity. This occurs because an

130 increase in the gas velocity leads to a decrease in the mean residence time of reactants in the
131 reactor, and also to an enhancement of the projection height of solid particles. These projected
132 particles contributes to the dilute phase temperature increasing and thus on the combustion.
133 Results obtained at bed temperatures lower than 750 °C were similar to those presented in this
134 section for 700 °C.

135 **Mean particle diameter effect.**

136 The effect of the mean particle diameter has been investigated between 100 and
137 550 µm (runs C1, C8 and C9 in Table 1). The superficial gas velocity was kept constant,
138 equivalent to twice the minimum fluidization velocity of particles 350 µm in diameter at 20
139 °C. Figure 7 presents the methane conversion as a function of the height at 700 °C for each
140 size of particles. Decreasing the mean particle diameter makes the combustion zone move
141 upwards to the reactor outlet, what is a consequence of the significant enhancement of two
142 parameters: the direct contact surface between gas and solid particles, and the particles hold-
143 up in the freeboard region, caused by an increase in the bubbles velocity and diameter at the
144 dense bed surface. At constant fluidizing velocity, decreasing the particle size leads to an
145 increase in the excess gas velocity ($U_g - U_{mf}$) what affects strongly the bubble size and
146 velocity. Similar behaviour was observed at the other dense bed temperatures tested in this
147 work.

148 **IV: REACTOR MODEL.**

149 The model for natural gas combustion process in the dense zone of the reactor is based
150 on the bubble assemblage model introduced by Kato and Wen (1969) what has been improved
151 to count for the thermal transfer that occurs during the combustion. It has ever been validated
152 at dense bed temperatures greater than 850 °C [Pré et al. (1998)]. The model is supplemented
153 with a freeboard modelling to count for the strong effects we experimentally evidenced of the

154 freeboard on the global bed combustion when the bed temperature T_{bed} is kept lower than the
155 critical temperature of 800 °C. The following assumptions are considered:

156 I. The freeboard region is fed only by the gas contained in bubbles; the temperature and
157 composition of which are that of the bubble phase at the bed surface.

158 II. The projected particles originate from the bubble wakes. They are projected by
159 packets having initial velocities equal to the bubble rise velocity at the dense bed
160 surface.

161 III. The particle projection by packets makes only a fraction of their total surface
162 accessible to gas. A contact efficiency factor is thus introduced.

163 IV. The entrained particle flux, the contact efficiency factor and the solid hold-up along
164 the freeboard fall exponentially from their values at the dense bed surface.

165 V. The gas phase and the particle phase flows are plug flows without and with back flow,
166 respectively.

167 VI. The freeboard region is subdivided into a number of elementary compartments.

168 **IV.1: HEAT TRANSFER IN THE FREEBOARD.**

169 The following mechanisms are counted in the modelling:

170 (4) the gas-to-particle convection.

171 (5) the gas-particle-suspension-to-reactor-wall conduction and radiation.

172 (6) the particle-to-particle radiation.

173 As a first approximation, the radial heat transfer resistance is assumed to be located in a thin
174 film at the reactor wall.

175 The convective heat transfer coefficient between gas and solid particles is modelled
176 using the Ranz and Marshall's correlation.

177 **IV.1.1: Gas-particle suspension to reactor-wall transfer.**

178 The model is similar to that proposed by Kunii and Levenspiel (1991) for the dense
179 region of the reactor. The heat flow exchanged between the gas-particle suspension and the
180 reactor wall is the sum of conductive and radiative contributions:

$$181 \quad q = q_c + q_{re} \quad (1)$$

182 Since the extinction coefficient ($\tau_p = 1,5 \cdot f_v \cdot \varepsilon_p / d_p$) is much higher than unity (3,85 for a
183 system with 1 % solid hold-up and 350 μm mean particle diameter), the gas-solid suspension
184 is considered as a grey surface as well as the reactor-wall. Thus, the radiative contribution can
185 be written:

$$186 \quad q_{re} = \frac{\sigma \cdot (T_p^4 - T_w^4)}{\frac{1}{\varepsilon_w} + \frac{1}{\varepsilon_g} - 1} \quad (2)$$

187 where ε_g is the gas-particles suspension emissivity, what depends both on the emissivity of
188 the gas phase and the local particles concentration. Its value is estimated using the correlation
189 reported in the appendix.

190 The conductive contribution is governed by the conduction through a gas film near the reactor
191 wall. Its thickness can be estimated as $L_g = d_p / 2$. This contribution is expressed, according to
192 Kunii and Levenspiel, as :

$$193 \quad q_c = \frac{k_g}{L_g} \cdot (T_p - T_w) \quad (3)$$

194 **IV.1.2: Axial radiative heat transfer between different regions of the freeboard.**

195 Various experimental measurements have shown that when the natural gas combustion
196 occurs partially or totally in the freeboard zone, the temperature and the solid hold-up varies
197 continuously along the reactor axis [Dounit et al. (2001), Dounit (2001)]. These gradients
198 generate an axial radiative heat transfer which can significantly affect the chemical reaction.

199 An approach similar to that proposed by Bueters et al. (1974) was used in this work.
200 The freeboard zone is discretized into N compartments separated by virtual planes. The

201 radiative heat flux absorbed by each slice i of the freeboard and coming from all other
 202 freeboard slices can be expressed as:

$$\begin{aligned}
 q_{tot\ i} = & \bar{\epsilon}_{gi} \cdot (E_{i-1} + E_{i+1}) \\
 & + \sum_{j=1}^{j=i-2} \left(E_j \cdot \bar{\epsilon}_{gi} \cdot \prod_{k=i-1}^{j+1} (1 - \bar{\epsilon}_{gk}) \right) \\
 & + \sum_{j=i+2}^N \left(E_j \cdot \bar{\epsilon}_{gi} \cdot \prod_{k=i+1}^{j-1} (1 - \bar{\epsilon}_{gk}) \right)
 \end{aligned} \tag{4}$$

204 where E_j represents the radiative heat flow emitted in one direction by slice j :

$$E_j = \frac{1}{2} \cdot \bar{\epsilon}_{gj} \cdot \sigma \cdot (2 \cdot A) \cdot T_j^4 \tag{5}$$

206 **IV.2: HYDRODYNAMICS OF THE SYSTEM.**

207 Modelling of natural gas combustion in the freeboard region of a fluidized bed reactor
 208 necessitates prior knowledge of the solid hold-up and the flux of projected particles along this
 209 region. In Table 2 we present the correlations used.
 210 (Table 2).

211 **IV.3 : MODEL EQUATIONS.**

212 The mass balance is written for every principal species present in the gas phase (CH_4 ,
 213 O_2 , N_2 , H_2O , CO , CO_2 , and NO) while the heat balances are established separately both for
 214 gaseous and particulate phases (Table 3).
 215 (Table 3).

216 The model equations are solved in three steps:

- 217 I. Initially the heat and mass balances for each compartment of the dense region are
 218 solved,
- 219 II. Secondly, for each slice of the freeboard zone, the heat and mass balances are solved.
- 220 III. Finally the global heat and mass balances for the entire reactor is checked.

221 The systems of equations obtained both for the dense and for the freeboard zones are
 222 non-linear algebraic systems solved using the Newton-Raphson method. More details can be

223 found in Pré-Goubelle (1997) and Dounit (2001). From this procedure, we get the axial
224 profiles of different species mole fractions present in the gas stream and both gas and particle
225 temperatures profiles along the reactor. The heat loss due to conduction and radiation to
226 external medium can also be computed.

227 **V: DISCUSSION OF THE MODEL RESULTS.**

228 **V.1: KINETIC SCHEME.**

229 The kinetic schemes available of Dryer and Glassman (1973), Westbrook and Dryer
230 (1981), and Bradley et al. (1977) have been tested and compared to our experiments. The one
231 of Dryer and Glassman (1973) gives the best predictions. Only the results obtained with this
232 kinetics scheme are discussed here:

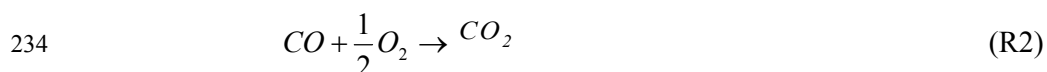
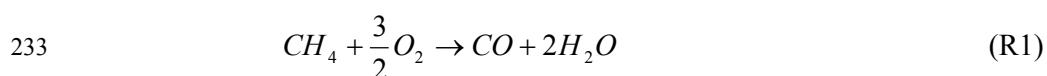

235 The rates of reactions R1 and R2 and the values of kinetic parameters involved are
236 reported in Table 4.

237 (Table 4).

238 At relatively low temperatures (less than 750 °C), good agreement has been obtained
239 for kinetic parameters giving the fastest reaction rate for methane transformation ($n=13.4$ and
240 $E=197.768 \text{ kJ.mol}^{-1}$), as shown in Figures 8 and 9. At dense bed temperatures closer to the
241 critical temperature of 800 °C, the best agreement was obtained for kinetic parameters of
242 methane transformation reaction closer to the mean values proposed by Dryer and Glassman
243 ($n = 13$ and $E = 197.768 \text{ kJ.mol}^{-1}$) as seen in Figures 10 and 11. Such modification in the
244 kinetics constant suggests that the mechanism of methane combustion does not occur only in
245 the homogeneous phase, and that sand particles may have a catalytic or inhibitive effect. This
246 is consistent with the previous experiments of Sotudeh-Gharebaagh (1998) showing a low

247 catalytic effect of sand particles at temperatures lower than 700°C, and an inhibitive effect at
248 temperatures between 750°C and 850°C.
249 (Figures 8, 9, 10 and 11).

250 **V.2: EFFECT OF OPERATING PARAMETERS.**

251 The excess air factor and the initial fixed bed height have a very weak effect on the
252 natural gas combustion process. The model matches well this observation (Dounit, 2001). The
253 strong effect of the gas superficial velocity and of the mean particle diameter is correctly
254 predicted by the model, as shown in Figure 12 at a dense bed temperature of 700 °C. In
255 addition, as shown in Figure 13, the measured mole fraction profiles are in good agreement
256 with the model predictions for different particles mean sizes.
257 (Figures 12 and 13).

258 **VI: CONCLUSION.**

259 In the present paper, a theoretical and experimental study of the influence of the
260 freeboard zone on the combustion of natural gas at temperatures lower than the critical
261 temperature have been presented. The experimental study demonstrates the progressive move
262 of the combustion zone towards the dense bed surface and thus into the interior of the dense
263 zone as the bed temperature rises. Increasing the fluidizing velocity or decreasing the mean
264 particle diameter induces the reaction zone displacement towards the reactor outlet. The
265 freeboard modelling combined with the dense bed modelling of Pré et al. (1998) predict
266 satisfactorily the reactor behaviour for different operating conditions. At dense bed
267 temperatures lower than the critical temperature, the methane burning is not an exploding
268 phenomenon mainly because of the existence of projected particles. The combustion occurs
269 progressively in the freeboard region and the conversion is total at the reactor outlet. Thus,
270 from a practical point of view, it seems necessary to use coarse particles with mean gas
271 velocities around 12 times the minimum fluidization velocity to ensure achievement of the

272 whole reaction in the reactor and to reach the maximum thermal efficiency of the reactor. The
273 fluidized bed reactor model gives useful information regarding the thermal efficiency of the
274 operation and permits estimation of the conditions at which the reactor efficiency is
275 maximum.

276 **APPENDIX.**

277 The gas-particle suspension emissivity $\bar{\varepsilon}_g$ is computed according to the following correlation:

$$278 \quad \bar{\varepsilon}_g = \varepsilon_p + C_s \cdot \varepsilon_g \quad (A1)$$

279 where ε_g and ε_p are respectively the emissivity of gas and particles. C_s is a factor depending
280 on the gas and solid emissivity, mean diameter and concentration of solid particles.

281 The particles emissivity is computed, for coarse particles, according to the following
282 correlation:

$$283 \quad \varepsilon_p = 1 - \exp\left(-1,5 \cdot f_v \cdot \frac{L}{d_p}\right) \quad (A2)$$

284 where L is the characteristic length.

285 The gas emissivity is calculated using the emissivity of absorbent gas (CO_2 and H_2O) given
286 by the Hottel correlation :

$$287 \quad \varepsilon_H = C_{CO_2} \cdot \varepsilon_{CO_2} + C_{H_2O} \cdot \varepsilon_{H_2O} - \Delta\varepsilon \quad (A3)$$

288 and the use of a blackening factor F_E in order to take into account the presence of species in
289 the gas stream other than CO_2 and H_2O :

$$290 \quad \varepsilon_g = (F_E - 1 + \varepsilon_H) / F_E \quad (A4)$$

291 In these correlations, ε_{CO_2} and ε_{H_2O} are the emissivity of carbon dioxide and water vapour,
292 respectively. C_{CO_2} , C_{H_2O} and $\Delta\varepsilon$ are factors depending on the partial pressure of gas species,
293 the gas temperature and the characteristic length. The blackening factor for the gas stream is
294 equal to 1.2 according to Bueters and al (1974).

295 **NOTATION.**

- 296 A : reactor cross sectional area (m^2).
- 297 C_{p_s} : specific heat of particles ($\text{J.kg}^{-1}.\text{k}^{-1}$).
- 298 C_i : concentration of species i in gas stream (mol.m^{-3}).
- 299 D_r : reactor diameter (m).
- 300 dh_i : height of compartments i (m).
- 301 d_p : mean particle diameter (m)
- 302 E_i : heat flux emitted by radiation from slice i and originate from this slice in
303 one direction. The total heat flux emitted being $2.E_i$ (W).
- 304 F : flux of entrained particles ($\text{kg.m}^{-2}.\text{s}^{-1}$).
- 305 F_0 : flux of entrained particles at dense bed surface ($\text{kg.m}^{-2}.\text{s}^{-1}$).
- 306 f_v : volume fraction of particles in each freeboard compartment.
- 307 f_w : bubbles volume fraction occupied by the wake.
- 308 h : height above the bed surface (m).
- 309 h_{gp} : heat transfer coefficient by convection between gas and solid particles ($\text{W.m}^{-2}.\text{k}^{-1}$).
- 310 h_{pw} : heat transfer coefficient by conduction and radiation between the gas-particle
311 suspension and reactor-walls ($\text{W.m}^{-2}.\text{k}^{-1}$).
- 312 H_i : molar enthalpy of species i (J.mol^{-1}).
- 313 k_g : gas phase conductivity ($\text{W.m}^{-1}.\text{K}^{-1}$).
- 314 L : characteristic height of a freeboard compartment (m).
- 315 L_g : gas film thickness (m).
- 316 q_c : heat flux exchanged by conduction between the gas-solid suspension and reactor
317 walls (w.m^{-2}).
- 318 q_{re} : heat flux exchanged by radiation between the gas-solid suspension and reactor
319 walls (w.m^{-2}).

- 320 $q_{tot i}$: heat flux absorbed by slice i and coming from all other regions per unit surface
 321 (w.m⁻²).
- 322 r_i : reaction rate for every gas species i (mol.m⁻³.s⁻¹).
- 323 R : reactor radius (m).
- 324 T_{bed} : dense bed average temperature (k).
- 325 T_g : gas temperature (k).
- 326 T_p : particle temperature (k).
- 327 T_w : reactor wall temperature (k).
- 328 U_g : superficial gas velocity (ms⁻¹).
- 329 U_{mf} : minimum fluidising velocity of solid particles (m.s⁻¹).
- 330 U_i : interstitial gas velocity (m.s⁻¹).
- 331 y_i : mole fraction of species i in gas stream.
- 332 Z : height above the gas distributor (m).

333

334 **Greek letters.**

- 335 ΔP_i : Mean pressure drop (Pa).
- 336 ε_{mf} : dense bed voidage at minimum fluidising conditions.
- 337 ε : local freeboard voidage.
- 338 $\bar{\varepsilon}_g$: gas-particles suspension emissivity.
- 339 ε_w : emissivity of reactor walls.
- 340 ε_p : particles emissivity
- 341 ρ : gas-particle suspension density (kg/m³).
- 342 ρ_0 : gas-particle suspension density at bed surface (kg/m³).
- 343 ρ_s : density of the particles (kg/m³).

- 344 η : contact efficiency at height h.
- 345 η_{bed} : contact efficiency at bed surface.
- 346 σ : Stefan-Boltzmann constant ($5.67 \cdot 10^{-8} \text{ w/m}^2 \cdot \text{k}^4$).
- 347 σ_i : Standard deviation of pressure drop fluctuations (Pa).

348 **Dimensionless numbers.**

349 Reynolds number $Re = \frac{\rho_g \cdot U_i \cdot d_p}{\mu_g}$

350 Prandtl number $Pr = \frac{\mu_g \cdot Cp_g}{k_g}$

351 **REFERENCES.**

- 352 [1] **Baskakov A.P., Makhorin K.E, (1975)** "*Combustion of natural gas in fluidized beds*",
 353 Inst of Fuel symp. Series. 1 : Fluidized combustion, C3-1.
- 354 [2] **Bradley D., Chin S. B., Draper M. S., Hakinson G., (1977)** "*Aerodynamic and flame*
 355 *structure within a jet-stirred reactor*", 16th Symp. On combustion, The combustion inst.,
 356 Pittsburg, pp 1571.
- 357 [3] **Bueters K. A., Cogoli J. G., Habelt W. W., (1974)** "*Performance prediction of*
 358 *tangentially fired utility furnaces by computer model*", 15th Int. Symp. on combustion,
 359 Tokyo, Japan.
- 360 [4] **Chen G. T., Shang J. Y., Wen C. Y., (1982)** "*Freeboard model for fluidized bed*
 361 *combustors*", In Fluidization Sci. and Tech., M. Kwauk and D. Kunii edns., Science
 362 press, Beijing,
- 363 [5] **Dounit S., (2001)** "*Combustion du gaz naturel en réacteur à lit fluidisé : Etude*
 364 *expérimentale et modélisation de la zone dense et de la zone de désengagement*", Thèse
 365 de Doctorat, INP-ENSICG, Toulouse.

- 366 [6] **Dounit S., Hémati M., Steinmetz D., (2001)** "*Natural gas combustion in fluidized bed*
367 *reactors between 600 and 850 °C: experimental study and modelling of the freeboard*"
368 Powder Technology, 120 (1-2), pp 49-54
- 369 [7] **Dryer F. L., Glassman I., (1973)** "*High temperature oxidation of CO and CH₄*", 14th
370 Symp. Int. On combustion, The comb. Inst. Pittsburg, pp 987.
- 371 [8] **Foka M., Chaouki J., Guy C., Klvana D., (1994)**"*Natural gas combustion in a*
372 *catalytic turbulent fluidized bed*", Chem. Eng. Sci. 49 (24A) pp 4261-4276.
- 373 [9] **Fournol A. B., Bergougnou M. A., Baker C. G. J., (1973)** "*Solids entrainment in a*
374 *large gas fluidized bed*", Can. J. of Chem. Eng., 51 pp 401-404.
- 375 [10] **George S. E., Grace J. R., (1978)** "*Entrainment of particles from aggregative fluidized*
376 *beds*", AIChE Symp. Series, 74, 176 pp 67-73.
- 377 [11] **Kato, K., Wen, C. Y., (1969)** "*Bubble assemblage model for fluidized bed catalytic*
378 *reactor*" , Chem. Eng. Sci., 24, pp 1351-1369.
- 379 [12] **Kunii D., Levenspiel O., (1990)** "*Fluidized reactor models : 1. For bubbling beds of*
380 *finest, intermediate and large particles. 2. For the lean phase : Freeboard and fast*
381 *fluidization*" Ind. Eng. Chem. Res., 29, pp 1226-1234.
- 382 [13] **Kunii D., Levenspiel O., (1991)** "*Fluidization engineering*", 2nd edition, Butterworth
383 Heinemann, Boston.
- 384 [14] **Miyauchi T., (1974)** "*Concept for successive contact mechanism for catalytic reaction*
385 *in fluid beds*", J. of Chem. Eng. of Japan, 7 (3), pp 201-207.
- 386 [15] **Pré-Goubelle P., (1997)** "*Contribution à l'étude expérimentale et à la modélisation de*
387 *la combustion du gaz naturel en réacteur à lit fluidisé*", Thèse de Doctorat INP-
388 ENSIGC Toulouse.

- 389 [16] **Pré, P., Hémati M. and Marchand B., (1998)** *"Study of natural gas combustion in*
390 *fluidized beds: modelling and experimental validation"*, Chem. Eng. Sci., 53 (16), pp
391 2871.
- 392 [17] **Ranz W. E., Marshall W. R., (1952)** Chem. Eng. Progress, 48, 141.
- 393 [18] **Sadilov P. V., Baskakov A. P., (1973)** *"Temperature fluctuations at the surface of a*
394 *fluidized bed with gas combustion occurring therein"*, Int. J. of Chem. Eng., 13 (3), pp
395 449.
- 396 [19] **Sotudeh-Gharebaagh (1998)** *"Combustion of natural gas in a turbulent fluidized bed*
397 *reactor"*, PhD Thesis report, Ecole Polytechnique de Montréal, QC, Canada.
- 398 [20] **Van Der Vaart D. R., (1992)** *"Mathematical modelling of methane combustion in a*
399 *fluidized bed"* Ind. Eng. Chem. Res., 31, pp 999-1007.
- 400 [21] **Wen, C.Y. and Chen, L.H., (1982)** *"Fluidized bed freeboard phenomena :*
401 *entrainment and elutriation"*, AIChE J., 28 (1), pp117-128.
- 402 [22] **Westbrook C. K., Dryer F. L., (1981)** *"Simplified reaction mechanisms for the*
403 *oxidation of hydrocarbon fuels in flames"*, Comb. Sci. and Tech. 27 (31).
- 404 [23] **Yanata I., Makhorin K. E., Glukhomanyuk A. M., (1975)** *"Investigation and*
405 *modelling of the combustion of natural gas in a fluidized bed of inert heat carrier"*, Int.
406 J. Chem. Eng., 15 (1) pp 68-72.
- 407 [24] **Yates J. G., Rowe P. N., (1977)** *"A model for chemical reaction in the freeboard*
408 *region above a fluidized bed"*, Trans. Instn. Chem. Engrs., 55, pp 137.
- 409 [25] **Zenz F. A., Weil N. A., (1958)** *"A theoretical-empirical approach to the mechanism of*
410 *particle entrainment from fluidized beds"*, AIChE J. 4 (4), pp 472-479.

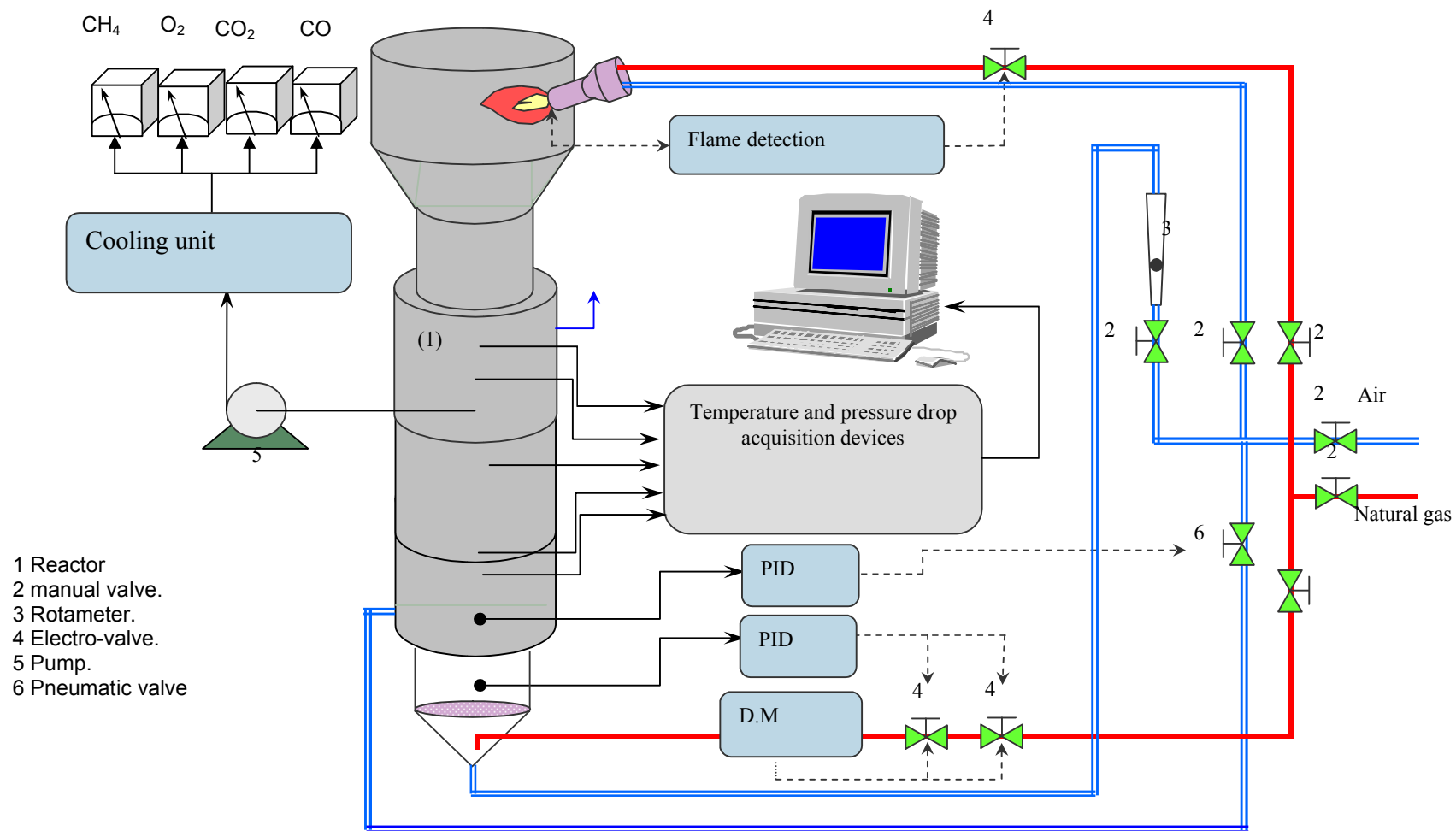

Figure 1: schematic of the set-up.

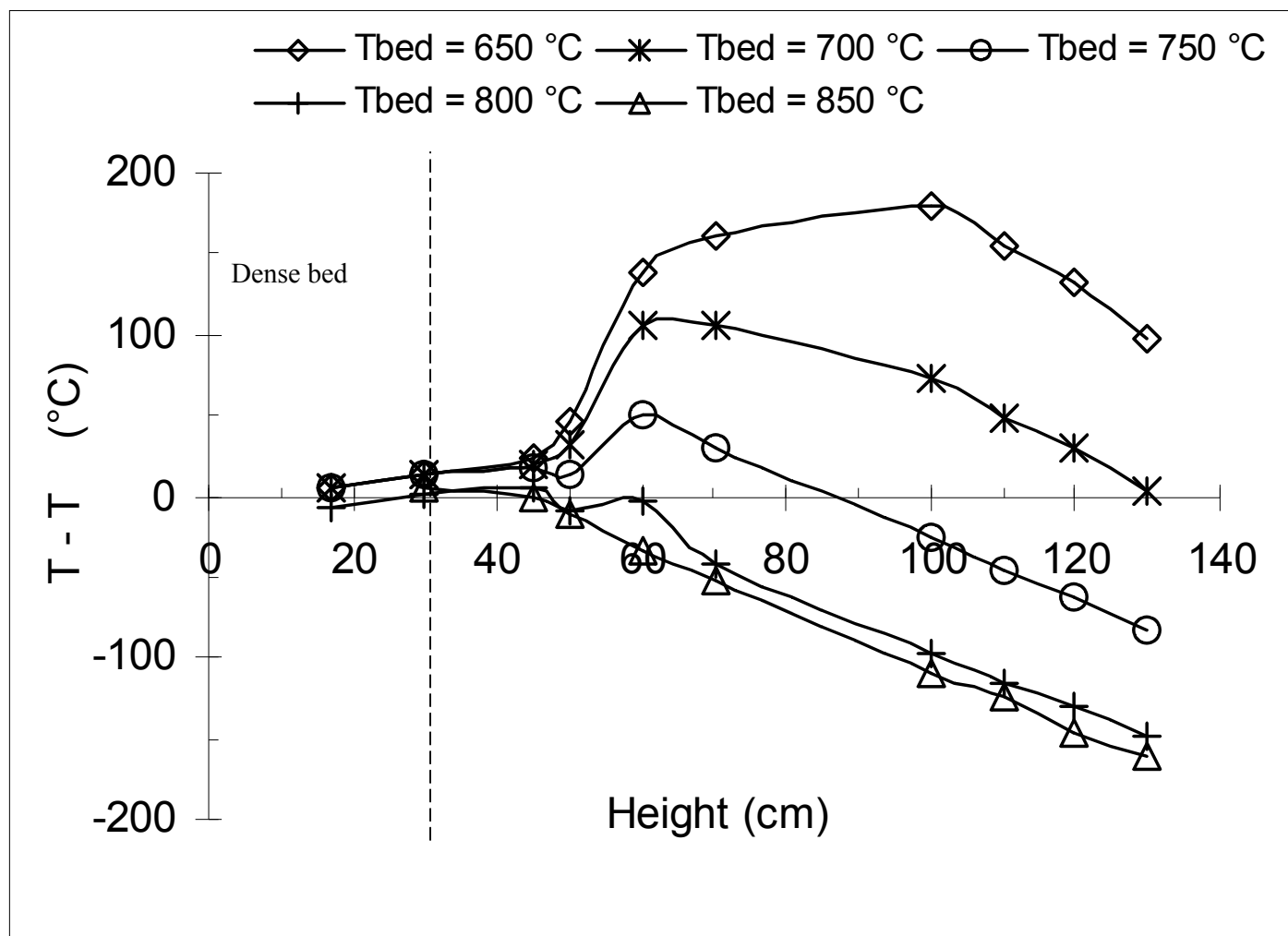

Figure 2: Evolution of the difference $T - T_{bed}$ along the reactor for different dense bed temperatures.

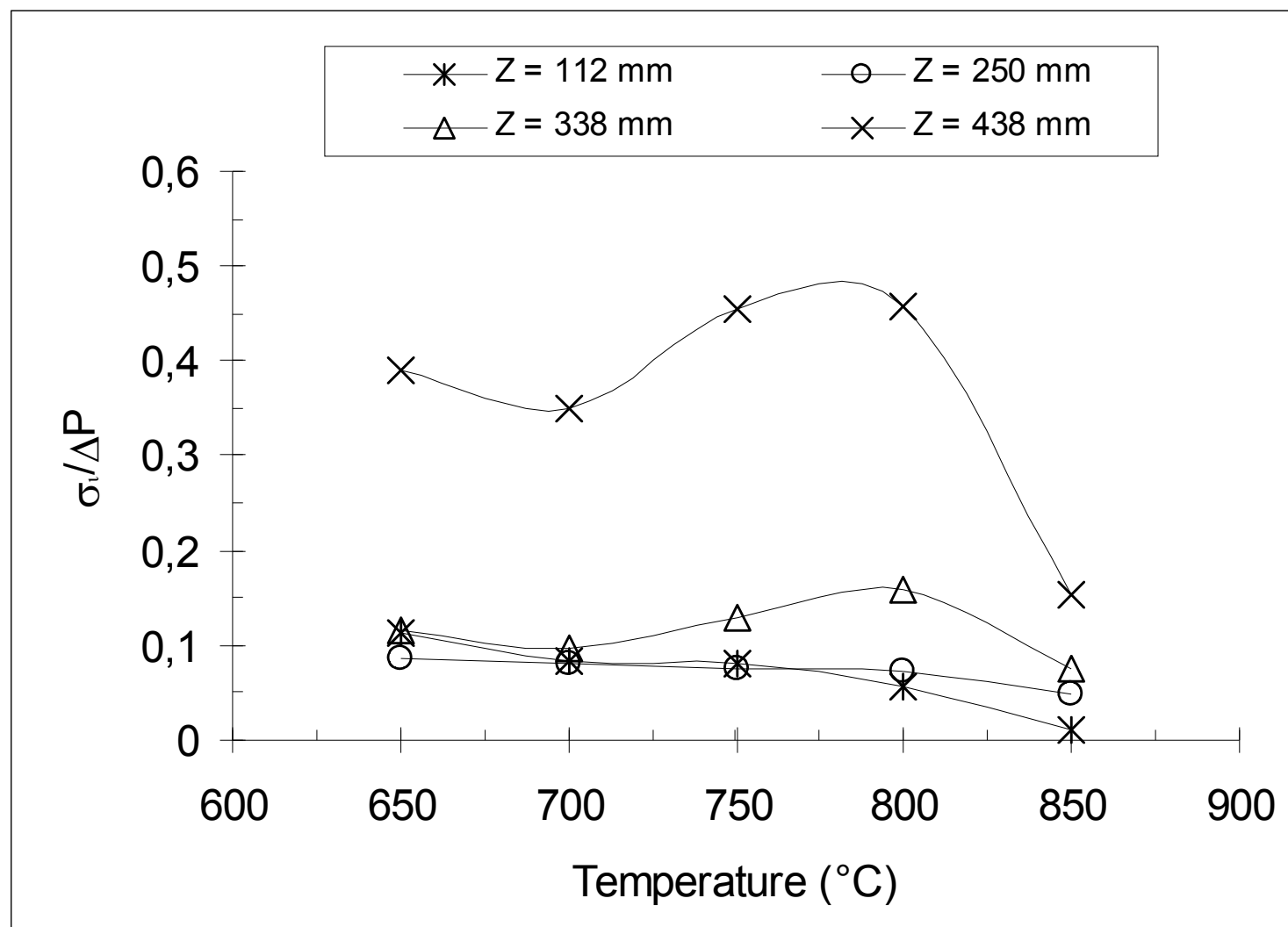

Figure 3: Normalised standard deviation of pressure drop fluctuations at different heights in the reactor against dense bed temperature.

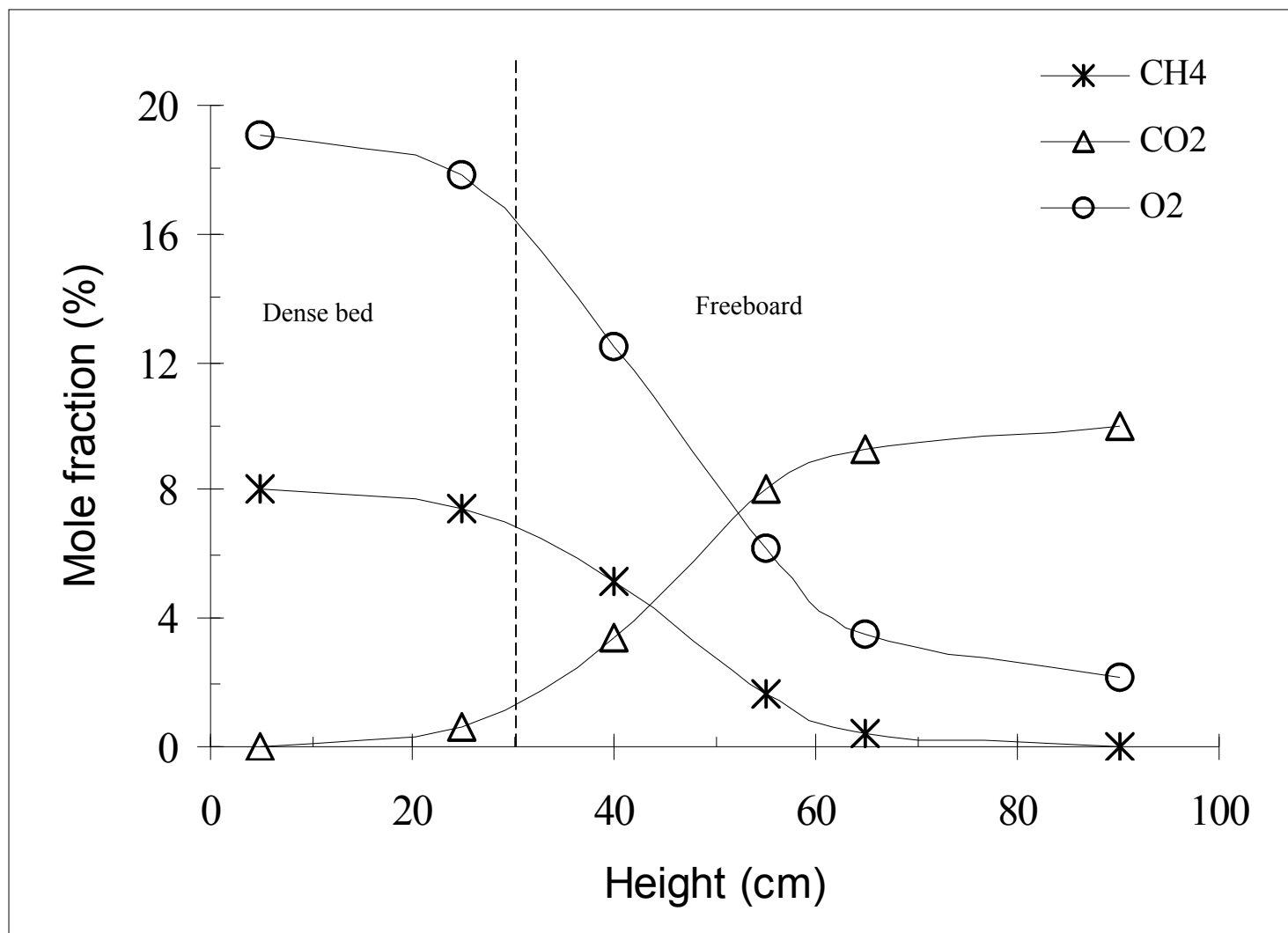

Figure 4-a: Mole fraction profiles of stable chemical species (Test C1, $T_{bed} = 700$ °C).

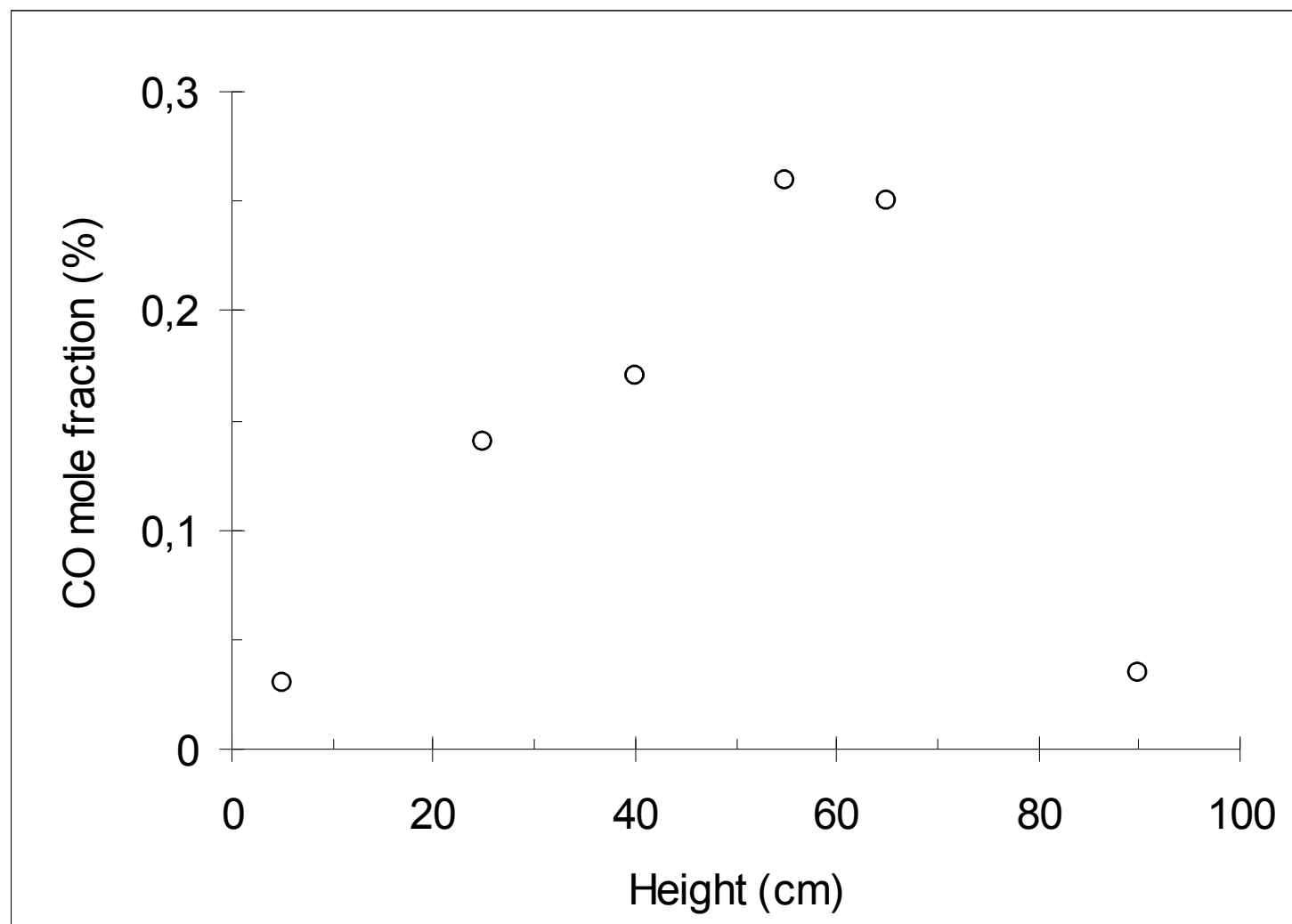

Figure 4-b: CO mole fraction profile (Test C1, $T_{bed} = 700$ °C).

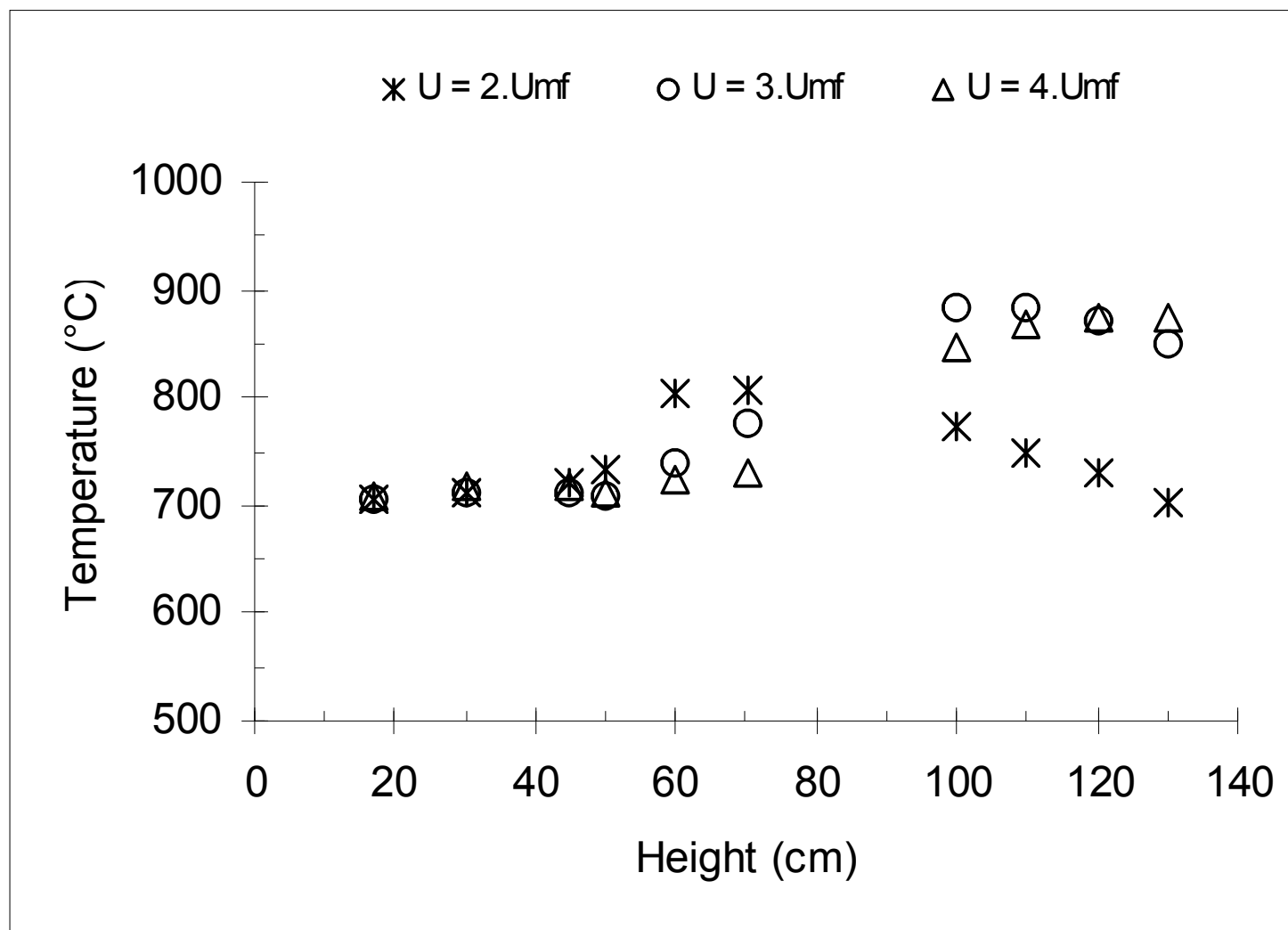

Figure 5: Temperature profiles obtained at $T_{bed} = 700$ °C for three values of gas velocity.

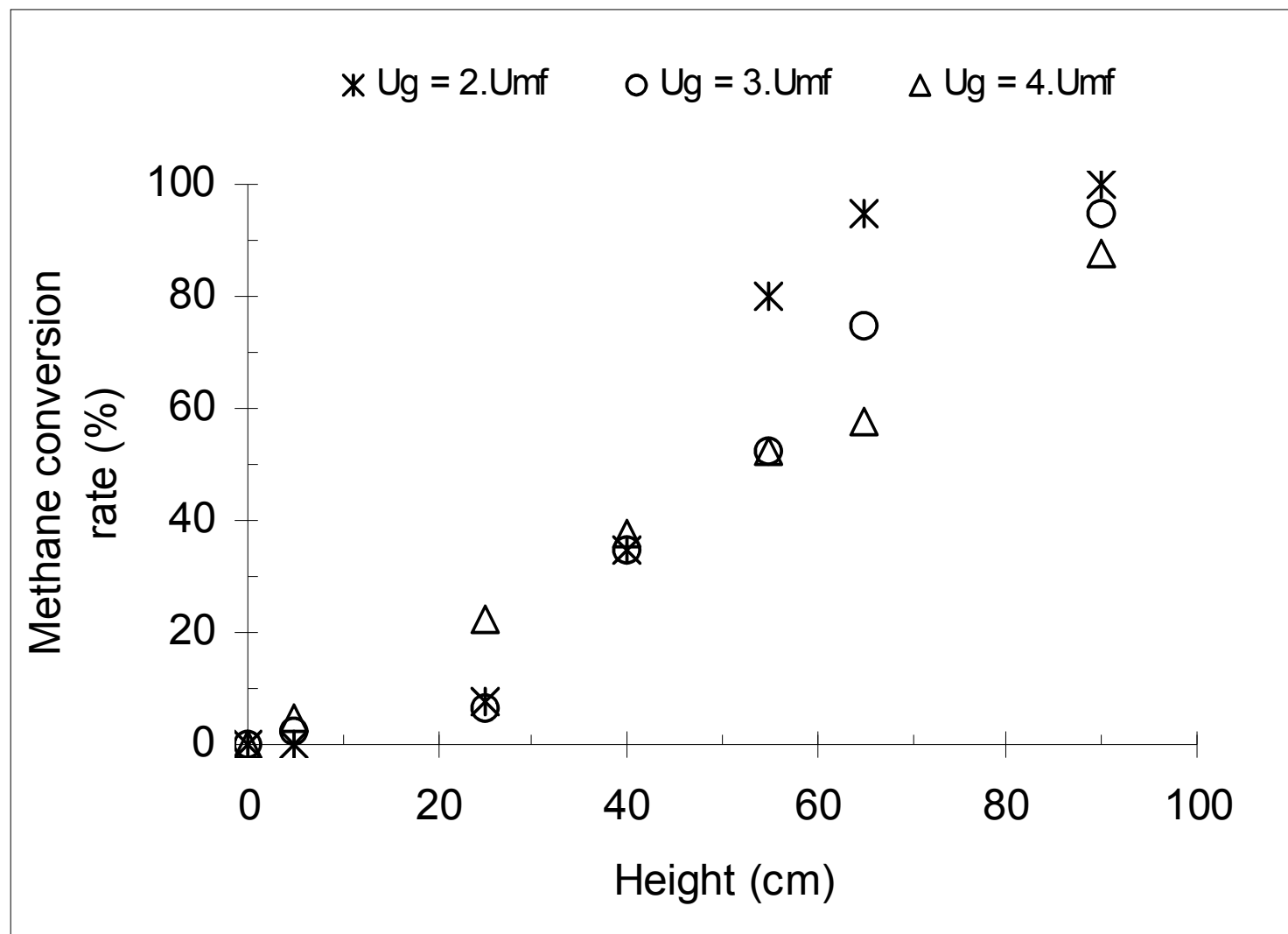

Figure 6: Methane conversion rate profiles at $T_{bed} = 700$ °C for three values of gas velocity.

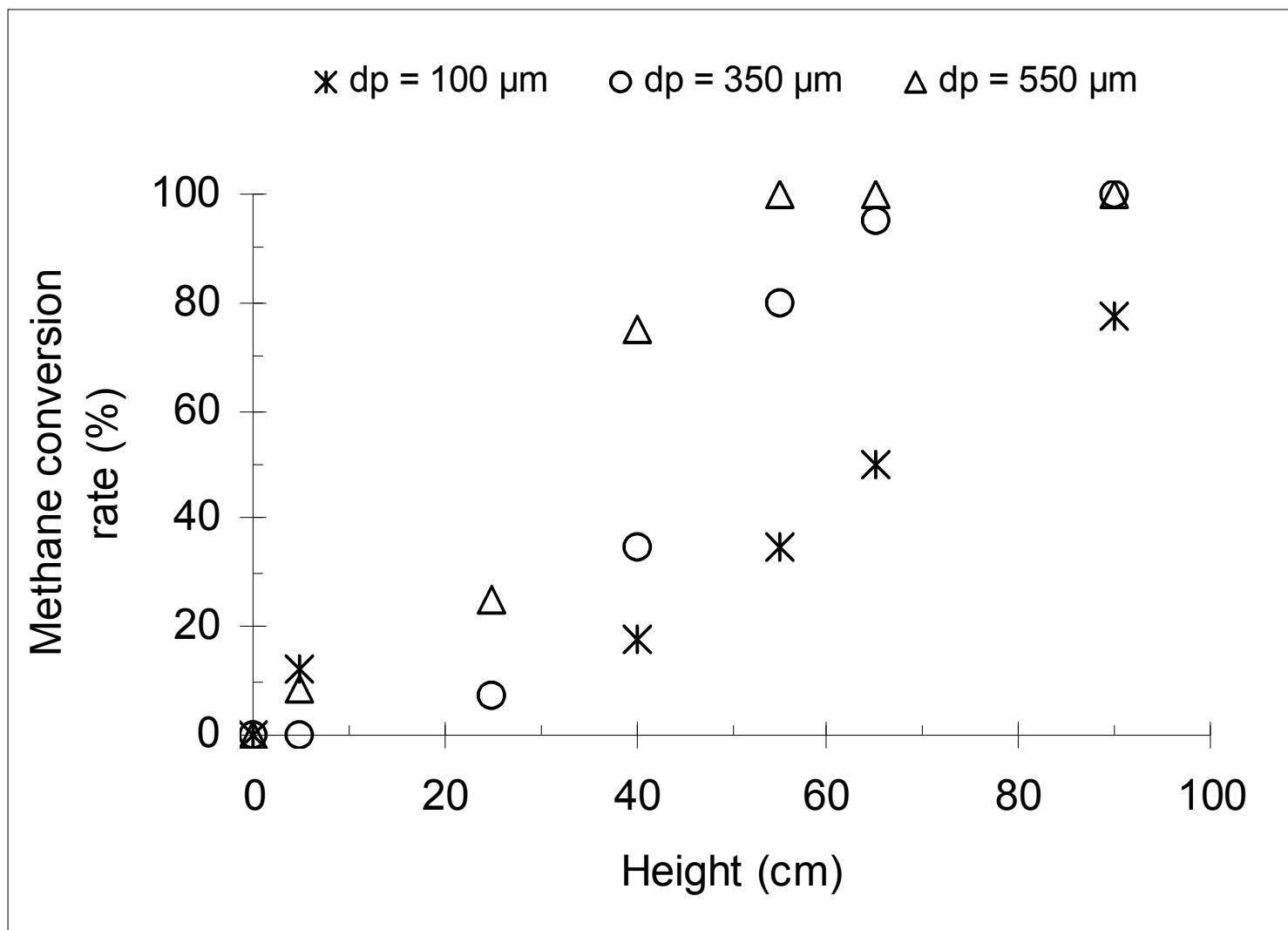

Figure 7: Methane conversion rate at 700 °C for three particle sizes.

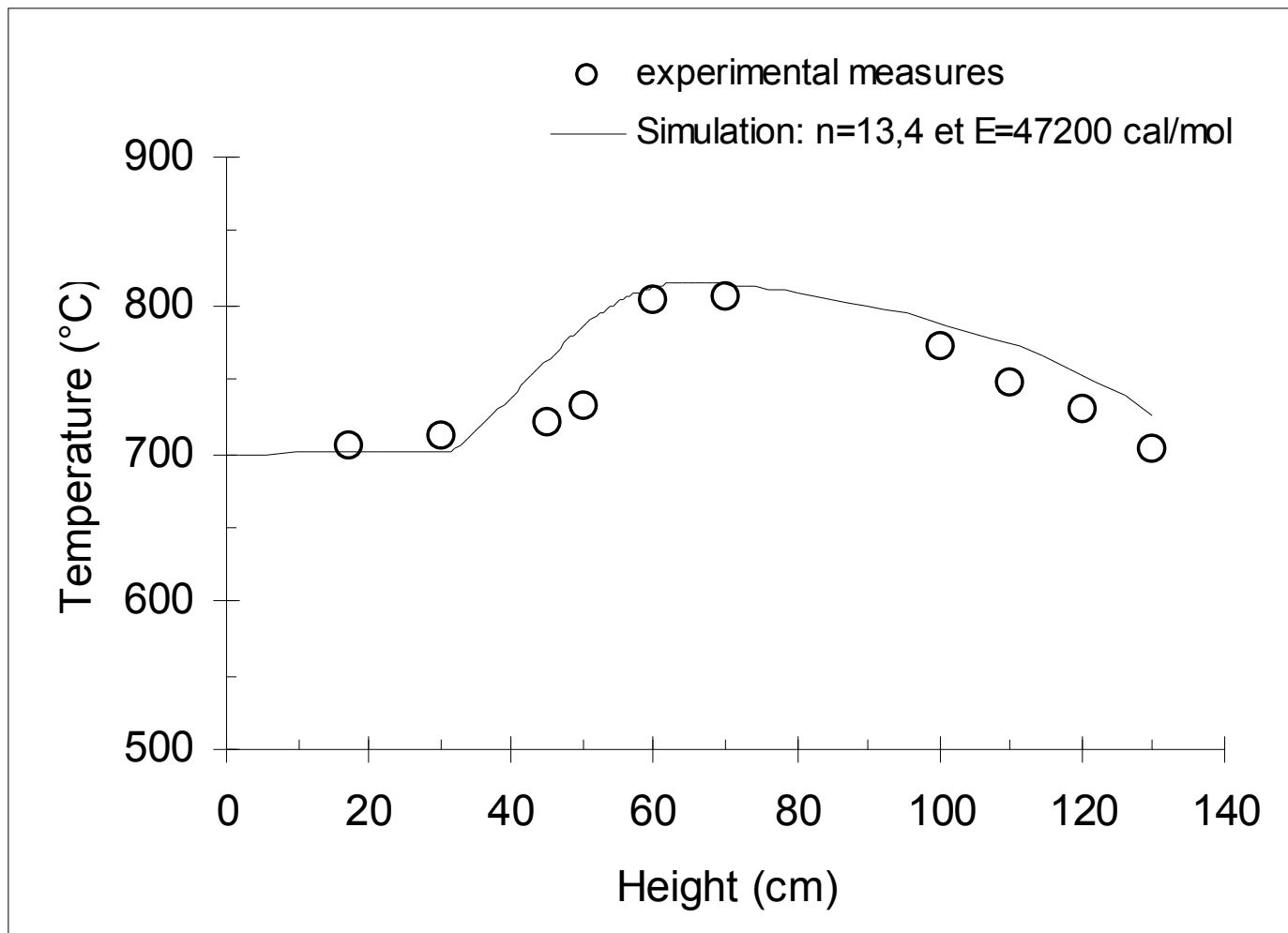

Figure 8: Temperature profile of gas-particles suspension: Comparison between the experimental results and the model predictions ($T_{bed} = 700$ °C).

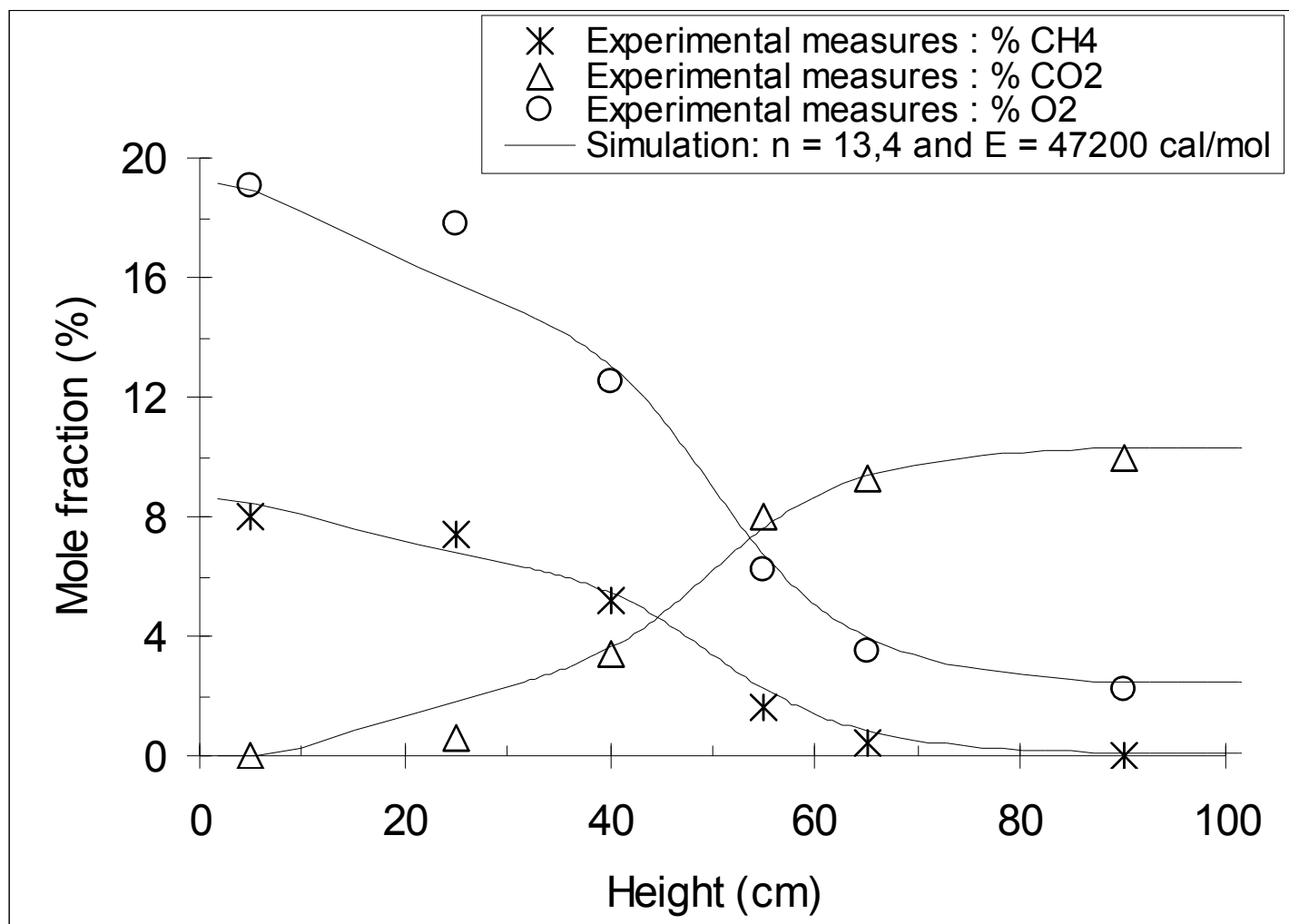

Figure 9: Mole fraction profiles of the main species present in gas stream: Comparison between the experimental results and the model predictions ($T_{bed} = 700$ °C).

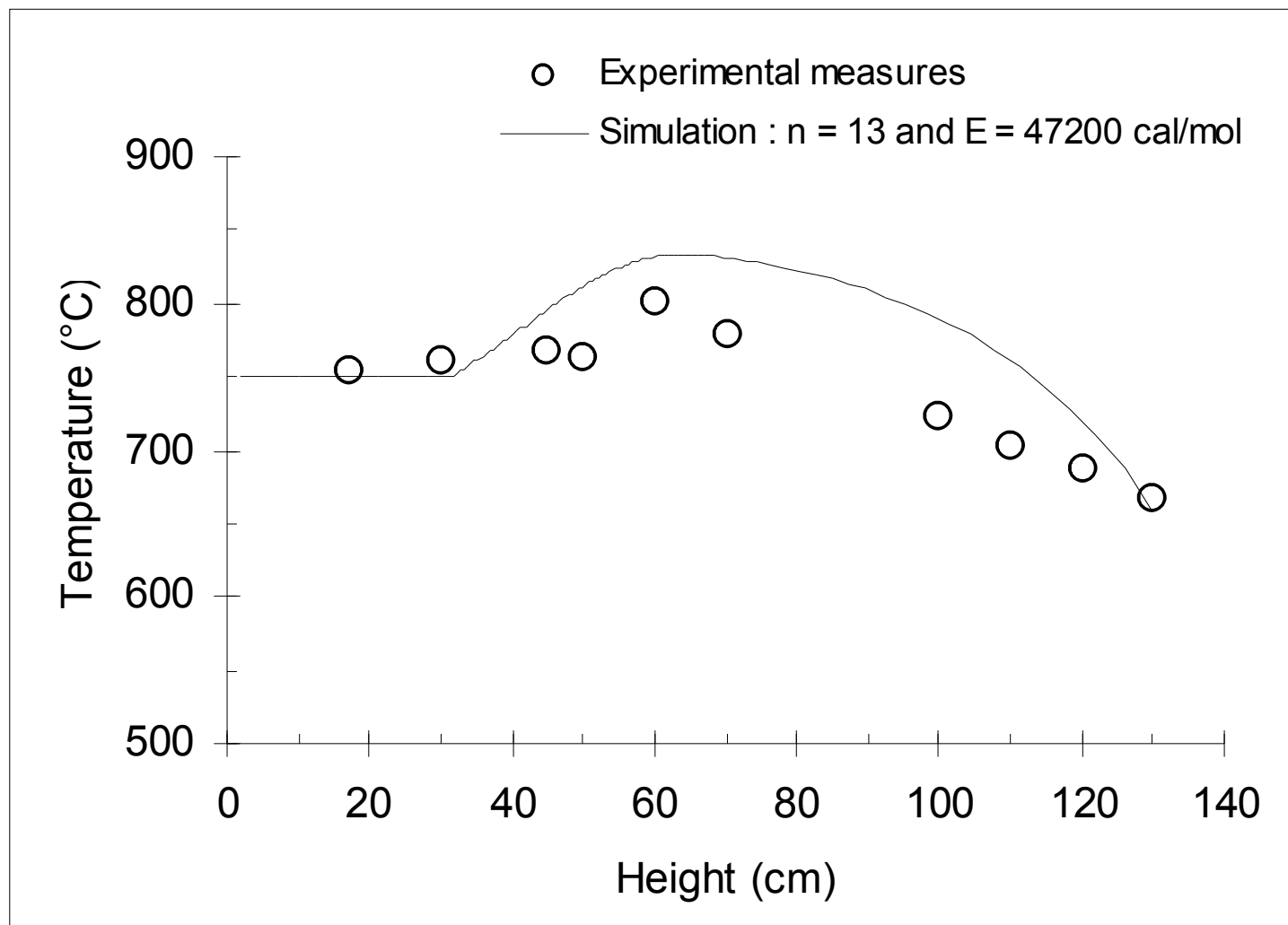

Figure 10: Temperature profile of gas-particle suspension: Comparison between the experimental results and the model predictions ($T_{bed} = 750$ °C).

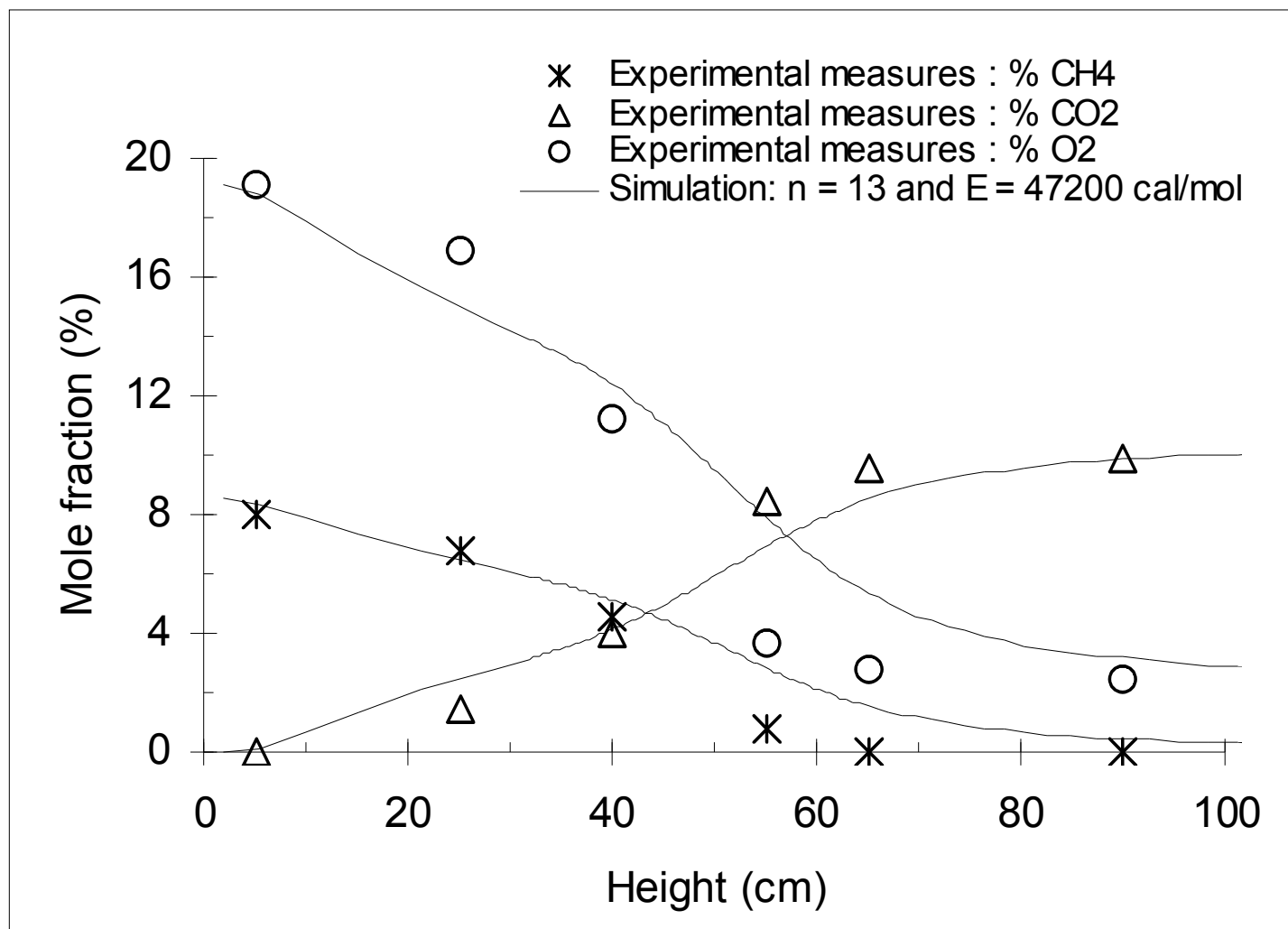

Figure 11: Mole fraction profiles of the main species present in gas stream: Comparison between the experimental results and the model predictions ($T_{bed} = 750$ °C).

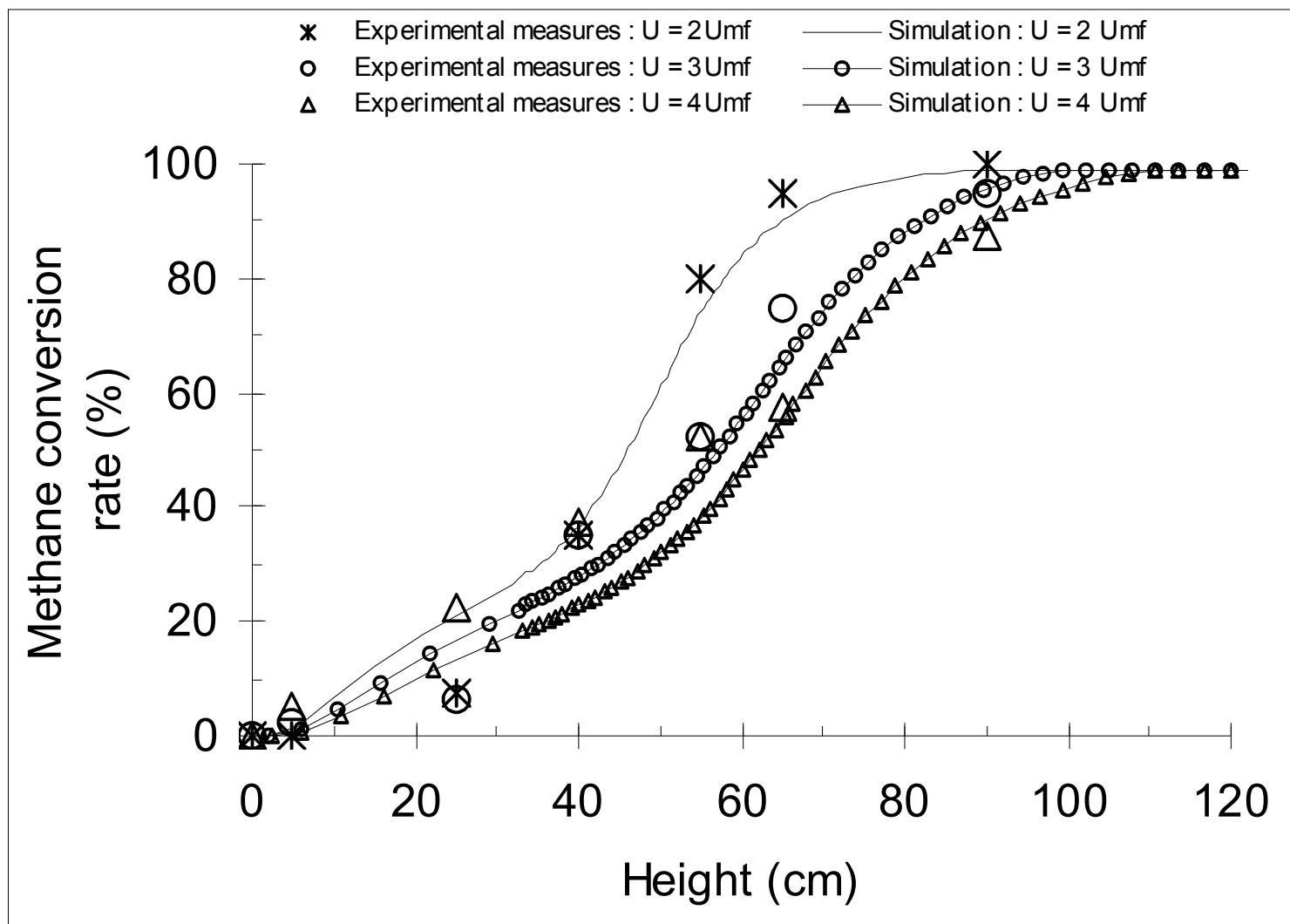

Figure 12: Comparison between experimental results and model predictions: Effect of superficial gas velocity.

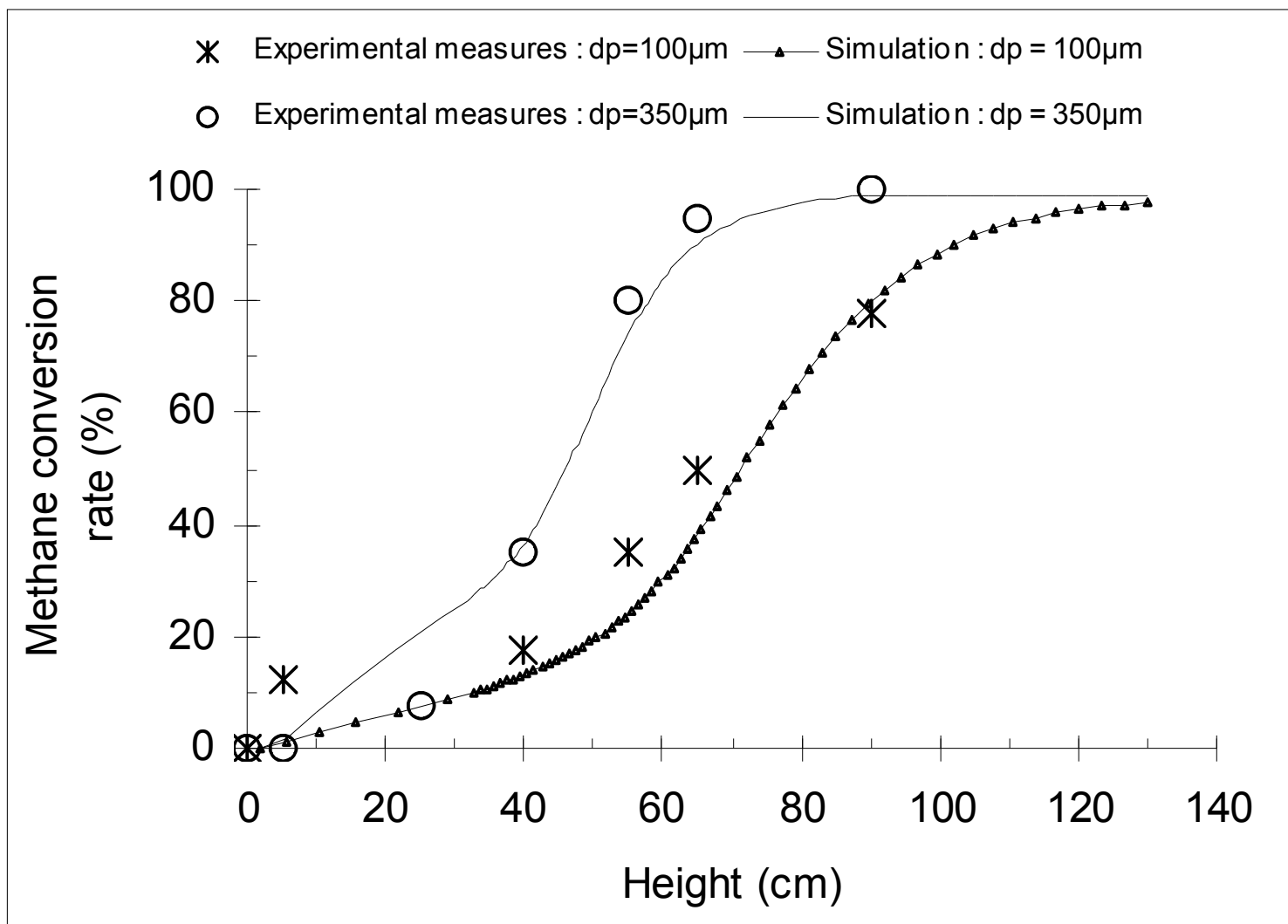

Figure 13: Comparison between experimental results and model predictions: Effect of the mean particle diameter.

<i>Experience</i>	<i>Solid mass (kg)</i>	<i>U_g/U_{mf} at 20 °C</i>	<i>Excess air factor</i>	<i>dp (μm)</i>	<i>Variable parameter</i>
C1	12	2	1,2	350	Reference
C2	9	2	1,2	350	Solid mass
C3	15				
C4	12	3	1,2	350	Superficial gas velocity
C5		4			
C6	12	2	1	350	Excess air factor
C7			1,5		
C8	12	2	1,2	100	Mean particle diameter
C9				550	

Table 1: *Operating conditions of premixed air-natural gas combustion experiments.*

Variable	Correlation	Reference
Solid hold-up	$\rho = \rho_0 \exp(-a \cdot h)$	[12]
Entrainment	$F = F_0 \exp(-a \cdot h)$	[13]
flux of particles projected at the bed surface	$F_0 = \frac{1}{2} \cdot f_w \cdot (1 - \varepsilon_{mf}) \cdot \rho_s \cdot (U_g - U_{mf})$ with $f_w = 0,25$	[13]
Contact efficiency factor	$(1 - \eta) = (1 - \eta)_{bed} \exp(-a' \cdot h)$ with $a' = 6.62 \text{ m}^{-1}$	[13]
Exponential factor "a"	Graphical correlation of Kunii and Levenspiel (1990)	[12]

Table 2: Correlations used for the hydrodynamic parameters.

Mass balance	$3[U_g C_i]^N - 4[U_g C_i]^{N-1} + [U_g C_i]^{N-2} - 2 \cdot \varepsilon_N \cdot r_i \cdot dh_N = 0 \quad i = 1, Nc$	
Heat balance	gas phase	
	$3 \left[\frac{U_g}{T_g} \sum_{i=1}^{NC} y_i H_i \right]^N - 4 \left[\frac{U_g}{T_g} \sum_{i=1}^{NC} y_i H_i \right]^{N-1} + \left[\frac{U_g}{T_g} \sum_{i=1}^{NC} y_i H_i \right]^{N-2}$ $+ 2 \cdot \frac{6}{d_p} (1 - \varepsilon_N) \cdot h_{gp} \cdot \frac{R}{P} \cdot (T_g ^N - T_p ^N) \cdot \bar{\eta}_N \cdot dh_N = 0$	
	particulate phase	
	$\left\{ \begin{aligned} & F_a ^N \cdot cp_s \cdot A \cdot (T_p ^N - T_{ref}) + F_d ^N \cdot cp_s \cdot A \cdot (T_p ^N - T_{ref}) \\ & + \frac{6}{d_p} (1 - \varepsilon_N) \cdot \bar{\eta}_N \cdot h_{gp} \cdot A \cdot (T_g ^N - T_p ^N) \cdot dh_N + q_{tot N} \end{aligned} \right\} -$	i
	$\left\{ \begin{aligned} & [F_a + F_d]^N \cdot cp_s \cdot A \cdot (T_p ^N - T_{ref}) + 2 \cdot \sigma \cdot A \cdot \bar{\varepsilon}_{gN} (T_p ^N)^4 + \\ & h_{pw} \cdot (\pi \cdot D_r \cdot dh_N) \cdot (T_p ^N - T_{w int}) \end{aligned} \right\} = 0$	1 CH ₄ 2 O ₂ 3 N ₂ 4 CO ₂ 5 H ₂ O 6 CO 7 NO
	<i>Particles to reactor wall heat transfer coefficient:</i>	
	$h_{pw} = \frac{k_g}{L_g} + \frac{\sigma \cdot (T_p + T_w) \cdot (T_p^2 + T_w^2)}{\frac{1}{\varepsilon_w} + \frac{1}{\bar{\varepsilon}_g} - 1}$	
	<i>Gas-to-particle heat transfer coefficient:</i>	
	$h_{gp} = \left(\frac{k_g}{d_p} \right) \cdot \left(2 + 0,6 \cdot Re^{1/2} \cdot Pr^{1/3} \right)$	

Table 3: Model equations (heat and mass balances).

<i>Reaction</i>	<i>Reaction rate expression</i>	<i>Kinetic parameters</i>
R1	$r_{CH_4} = -10^n \cdot C_{CH_4}^{0,7} \cdot C_{O_2}^{0,8} \cdot \exp\left[-\frac{E \times 4,18}{R \cdot T}\right] \cdot 10^{-3}$	$n = 13,2 \pm 0,2$ $E = 48400 \pm 1200 \text{ (cal.mol}^{-1}\text{)}$
R2	$r_{CO} = -10^n \cdot C_{CO} \cdot C_{O_2}^{0,25} \cdot C_{H_2O}^{0,5} \cdot \exp\left[-\frac{E \times 4,18}{R \cdot T}\right] \cdot 10^{-4,3}$	$n = 14,75 \pm 0,4$ $E = 43000 \pm 2200 \text{ (cal.mol}^{-1}\text{)}$

Table 4: Reaction rate expressions and kinetic parameters values according to Dryer and Glassman (1973).