



HAL
open science

Multiobjective optimization for multiproduct batch plant design under economic and environmental considerations

Adrian Dietz, Catherine Azzaro-Pantel, Luc Pibouleau, Serge Domenech

► **To cite this version:**

Adrian Dietz, Catherine Azzaro-Pantel, Luc Pibouleau, Serge Domenech. Multiobjective optimization for multiproduct batch plant design under economic and environmental considerations. *Computers & Chemical Engineering*, 2006, 30 (4), pp.599-613. 10.1016/j.compchemeng.2005.10.017 . hal-00475997

HAL Id: hal-00475997

<https://hal.science/hal-00475997>

Submitted on 2 Nov 2023

HAL is a multi-disciplinary open access archive for the deposit and dissemination of scientific research documents, whether they are published or not. The documents may come from teaching and research institutions in France or abroad, or from public or private research centers.

L'archive ouverte pluridisciplinaire **HAL**, est destinée au dépôt et à la diffusion de documents scientifiques de niveau recherche, publiés ou non, émanant des établissements d'enseignement et de recherche français ou étrangers, des laboratoires publics ou privés.

Multiobjective optimization for multiproduct batch plant design under economic and environmental considerations

A. Dietz, C. Azzaro-Pantel*, L. Pibouleau, S. Domenech

Laboratoire de Génie Chimique-UMR 5503 CNRS/INP/UPS, 5 Rue Paulin Talabot BP1301, 31106 Toulouse Cedex 1, France

Abstract

This work deals with the multicriteria cost–environment design of multiproduct batch plants, where the design variables are the size of the equipment items as well as the operating conditions. The case study is a multiproduct batch plant for the production of four recombinant proteins. Given the important combinatorial aspect of the problem, the approach used consists in coupling a stochastic algorithm, indeed a genetic algorithm (GA) with a discrete-event simulator (DES). Another incentive to use this kind of optimization method is that, there is no easy way of calculating derivatives of the objective functions, which then discards gradient optimization methods. To take into account the conflicting situations that may be encountered at the earliest stage of batch plant design, i.e. compromise situations between cost and environmental consideration, a multiobjective genetic algorithm (MOGA) was developed with a Pareto optimal ranking method. The results show how the methodology can be used to find a range of trade-off solutions for optimizing batch plant design.

Keywords: Batch plant design; Multicriteria genetic algorithm; Environmental impact

1. Introduction

Batch processes are typically used to manufacture low-volume high-value-added products (for instance, pharmaceuticals). In that context, batch process development is generally different from continuous traditional processes because of the need of approval of the production recipe by some organization (for instance, the Food and Drug Administration, FDA). Any later modification to the production recipe will require a new approval, so it is necessary to take into account as much as possible all the parameters and criteria from the earliest development steps for optimal batch plant design.

It must be emphasized that the design of batch plants has been for long been identified as a key problem in chemical engineering and much work has been presented in this area in the past few years, for instance (Cao & Yuan, 2002; Chunfeng & Xin, 2002; Goel Harish, Weijnen Margot, & Grievink Johan, 2004; Heo, Lee, Lee, Lee, & Park, 2003; Montagna, 2003; Chakraborty, Malcolm, Colberg Richard, & Linninger Andreas,

2004; Cavin, Fischer, Glover, & Hungerbühler, 2004; Pinto, Barbosa-Póvoa Ana Paula, & Novais Augusto, 2005). The formulation of batch plant design generally involves mathematical programming methods, such as linear programming (LP), nonlinear programming (NLP), mixed-integer linear programming (MILP) or mixed-integer nonlinear programming (MINLP). To use the above-mentioned methods (the list is not exhaustive), a mathematical model representing the batch plant must be developed. An objective function is then defined which refers in most cases to investment cost. Plant modeling involves satisfaction of constraints related for instance to time horizon or production requirements, . . . The main drawback of this methodology is the difficulty, even impossibility, to describe with a high degree of sophistication, the real constraints (various storage policies or operator shift, for instance, . . .). In other cases, the number of equations to take as constraints often renders the problem impossible to solve.

An alternative to purely mathematical approaches is to link discrete-event simulation (DES) to scheduling and planning problems. Although the list is not exhaustive, let us mention some well-known simulations tools: “Batches” from Batch Process Technologies, Batch Plus, SuperPro Designer and BatchDesign Kit (BDK). Since the development of a generic scheduling

* Corresponding author. Tel.: +33 5 34 61 52 72; fax: +33 5 34 61 52 53.
E-mail address: catherine.Azzaro@ensiacet.fr (C. Azzaro-Pantel).

model is an ambitious challenge because of the difficulty to embed in one formulation all features of every possible production system, a methodology of development of discrete-event simulators was proposed by (Bérard et al., 1999). The DES framework has thus proven its efficiency to support process development and was used for both scheduling and design purposes. In our previous works, the DES which serves to evaluate the feasibility of the production at medium term scheduling was coupled with a master optimization procedure based on a genetic algorithm (GA). The optimization variables are only discrete variables and the problem presents a marked combinatorial feature (the equipment sizes are considered as discrete values). Following these ideas, Dedieu, Pibouleau, Azzaro-Pantel, and Domenech (2003) generalized the approach to consider multicriteria design and retrofiting. The choice of a hybrid method GA/DES was then all the more justified as several criteria were simultaneously taken into account: a tradeoff between investment cost, equipment number, and a flexibility index based on the number of campaigns necessary to reach a steady-state regime was investigated.

Following these guidelines, this work is particularly motivated by the need to consider the capital cost as well as the environmental impact from the earliest design stage.

The study presented in this paper deals with the multicriteria cost–environment design of multiproduct batch plants, where the design variables are the equipment item sizes as well as the operating conditions identified as having an important impact on the optimization criteria. The formulation of the problem can be visualized as proposed in Fig. 1.

The cost criterion considered is classically based on investment minimization. Considering environmental impact (EI), let us recall that several methodologies are available in the literature. The most important concept perhaps refers to the life cycle assessment (LCA) methodology (Burgess & Brennan, 1999): it considers all the wastes generated in order to produce the different products in the upstream stages (i.e. raw material production, energy generation, etc.), in the study stage (i.e. solvents, non-valuable by-products, etc.) and in the downstream steps (i.e. recycling, incineration, etc.). The aim of LCA is to consider the wide chain in order to prevent pollution generation and to com-

pare the different alternatives to manufacture a product. Another concept used the pollution balance (PB) principle (Cabezas, Bare, & Mallick, 1999), equivalent to the balance made for mass or energy. It means that a process can not only pollute but also consume a polluting product and can be, consequently, a benign process.

Finally, the so-called pollution vector (PV) methodology (Stefanis, Livingston, & Pistikopoulos, 1995) consists in evaluating the environmental impact by means of an impact vector over different environments (i.e. water, air, etc.) defined as the mass emitted on an environment divided by the standard limit value in this environment.

A guideline of this work is to integrate all these aspects for batch plant design, as much as allowed by information availability for the study case.

This paper is organized as follows: Section 2 presents the process dedicated to the production of proteins used as an illustration of the proposed methodology. Section 3 is devoted to the environmental impact evaluation based on a classical LCA approach. Sections 4 and 5 respectively outline the methodology for multicriteria batch plant design and display results of the method applied to the studied plant. Section 6 concludes the current work and suggests new areas for investigation.

2. Process description

The case study is a batch plant for the production of proteins taken from the literature (Montagna, Vecchiotti, & Iribarren, 2000; Pinto, Montagna, Vecchiotti, Iribarren, & Asenjo, 2001). This is a multiproduct batch plant, with four products to be manufactured by fermentation and eight treatment stages. This example is used as a test bench since short-cut models describing the unit operations involved in the process are available. The batch plant involves eight stages for producing four recombinant proteins, on one hand two therapeutic proteins, Human insulin (I) and vaccine for Hepatitis B (V) and, on the other hand, a food grade protein, chymosine (C) and a detergent enzyme, cryophilic protease (P). The methodology is generic for any plant producing recombinant proteins from yeast.

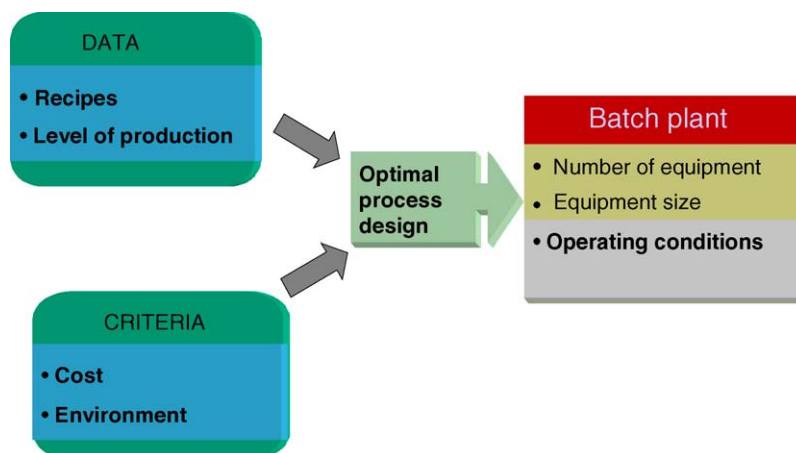

Fig. 1. Problem formulation.

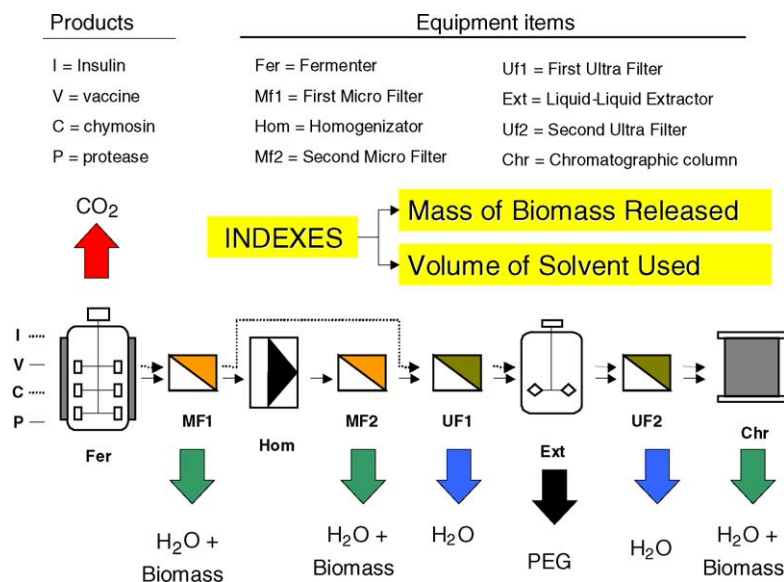

Fig. 2. Multiproduct batch plant for proteins production and environmental impact evaluation.

Fig. 2 shows the flowsheet of the multiproduct batch plant considered in this study. All the proteins are produced as cells grow in the fermenter (Fer).

Vaccine and protease are considered as being intracellular, hence, for these two products, the first microfilter (Mf1) is used to concentrate the cell suspension, which is then sent to the homogenizer (Hom) for cell disruption to liberate the intracellular proteins. The second microfilter (Mf2) is used to remove the cell debris from the solution proteins.

The ultrafiltration (Uf1), prior to extraction, is designed to concentrate the solution in order to minimize the extractor volume. In the liquid-liquid extractor (Ext), salt concentration (NaCl) is used to first drive the product to a polyethylene-glycol (PEG) phase and again into an aqueous saline solution in the back extraction.

Ultrafiltration (Uf2) is used again to concentrate the solution. The last stage is finally chromatography (Chr), during which selective binding is used to better separate the product of interest from the other proteins.

Insulin and chymosin are extracellular products. Proteins are separated from the cells in the first microfilter (Mf1), where cells and some of the supernatant liquid stay behind. To reduce the amount of valuable products lost in the retentate, extra water is added to the cell suspension.

The homogenizer (Hom) and microfilter (Mf2) for cell debris removal are not used when the product is extracellular. Nevertheless, the ultrafilter (Uf1) is necessary to concentrate the dilute solution prior to extraction. The final step of extraction (Ext), ultrafiltration (Uf2) and chromatography (Chr) are common to both the extracellular and intracellular products.

3. Environmental impact evaluation

Given the production recipes for the different products and the general flow-sheet, the first step consists in applying the LCA methodology to determine all the products contributing to the

environmental impact (Fig. 2). For information availability reasons, the study was reduced to the process being studied, which is of course a limited application of LCA. Products (i.e. vaccine) and raw materials (glucose, NH₃) were considered not having an environmental impact. After that, a PB is applied, using the PV to quantify the environmental impact. In this case, an adapted definition of the pollution vector was introduced, because the standard limit values for the polluting product were not found in the literature. This vector has two components; the former is the total biomass quantity released and the latter concerns the PEG volume used. Even if the solvent can be recycled, it cannot be carried out at 100%, so the environmental impact is considered to be proportional to this quantity. The pollution indexes were thus defined as the emitted quantities divided by the mass of the manufactured products. Let us remark that the environmental impact minimization can be viewed a multicriteria problem in itself.

4. Methodology for multicriteria batch plant design

4.1. General principles

The framework for batch plant design proposed in this study integrates simple unit operation models into the batch plant wide model, which is then embedded in an outer optimization loop (see Fig. 3). The approach adopted in this work consists in coupling a stochastic algorithm, indeed a genetic algorithm (GA) with a discrete-event simulator (DES) (Dietz, Azzaro-Pantel, Pibouleau, & Domenech, 2005). The objective of the master GA involved is to propose several good and even optimal solutions, whereas the DES allocates the products to equipment items and evaluates different criteria. More detail concerning the design of the DES can be found in (Dietz et al., 2005).

At this level, it will be reminded that stochastic algorithms, such as simulated annealing (SA) or genetic algorithms (GA) are more and more used for combinatorial optimization prob-

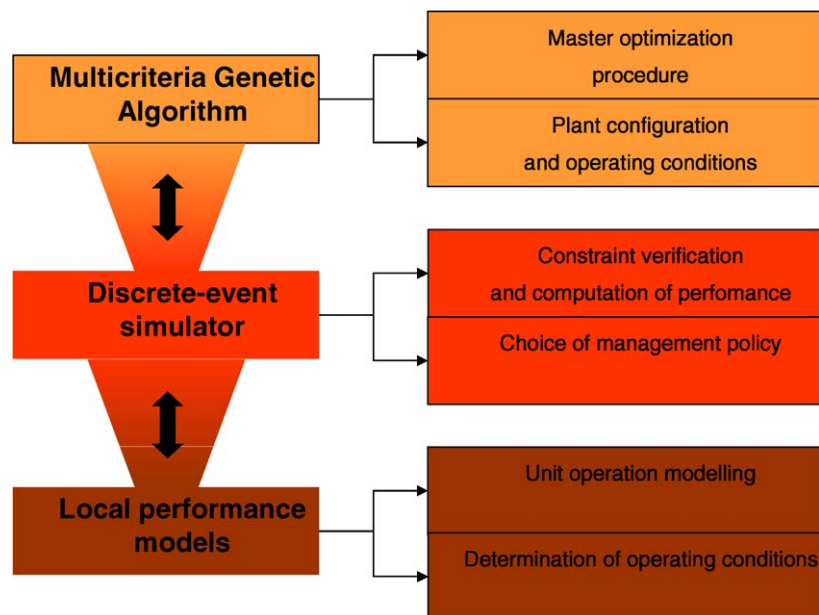

Fig. 3. Optimal batch plant design framework.

lems in various fields, and particularly in chemical engineering (Pibouleau, Floquet, Domenech, & Azzaro-Pantel, 1999). Given that: –practical industrial problems might not be “mathematically” understood when the design is started; –this study aims at batch plant design taking into account both investment cost and environmental impact, the choice of the stochastic optimization method is clearly justified. Several other reasons guide us to the choice of a genetic algorithm. The final aim is to treat a mixed-integer non-linear problem (MINLP). In chemical engineering, the combinatorial aspect of the problem is sometimes important: for example in batch plant design, the structure variables are the equipment sizes and number for each unit operation that generally take discrete values since discrete value ranges are available; as a consequence, an evolutionist algorithm is more suitable on the one hand to solve this kind of problem than the mathematical programming approach of large size problems. On the other hand, the evolutionist algorithms do not need any information about the mathematical properties (derivability, convexity etc.) of the function to optimize that sometimes are too difficult or impossible to establish; in this case the MOGA is developed in order to be coupled with a simulation tool that only gives values for the performance criteria selected. The inconvenient of this kind of optimization algorithm is that the optimality of the solution is not guaranteed. Different evolutionist algorithms have been presented and used in the dedicated literature: simulated annealing (SA) (Kirkpatrick, Gellat, & Vecchi, 1983) genetic algorithms (GA) (Fonseca & Fleming, 1995) and ants colony (AC) (Colomi, Dorizo, & Manniezzo, 1991). GA was selected here since it has the main advantage over other methods to manipulate a population of individuals and can directly lead to the whole set of compromise solutions in one single optimization run.

The development of the discrete-event simulation model was presented in detail in (Dietz et al., 2005) and will not be recalled here.

The process unit performance models are used to compute the operating time of each process step. A brief description of each process stage is also given in (Dietz et al., 2005) and the different assumptions used to compute the processing time and the mass balance through the plant are given (Pinto et al., 2001). Let us note that some differences in the hypothesis were carried out because this work aims at describing the involved unit operations with simple models, in order to obtain complete information about the treatment stage (i.e. flow composition, required amount of utilities, wastes, . . .). In the previous work (Asenjo, Montagna, Vecchiotti, Iribarren, & Pinto, 2000), the model was only used to compute the operating time and the corresponding efficiency, with a formulation based on constraints to solve the optimization problem.

In this work, classical chemical engineering balances are carried out at each treatment stage.

4.2. Optimization criteria

The cost criterion considered in this study is classically based on investment minimization because there was not enough information to evaluate the operational cost of the batch plant (raw material cost, utilities cost, . . .) and to embed it in a net present value computation.

The cost criterion involves investment cost for both equipment and storage vessels and is computed from classical formulae (see Eq. (1)), where the A constant was neglected:

$$\text{cost} = A + BV^\alpha \quad (1)$$

The numerical values of B and α were taken from the work of (Montagna et al., 2000).

Concerning the environmental impact, the quantity and the quality of the process effluents depend only on the operating conditions having an influence on mass balance at each treatment stage. The global index of each environmental impact criterion

is defined as weighted sum respect to the production of each product index (Eq. (2)). I_k is the pollution global index, I_k^i the k pollution index of i product defined as the amount of the k pollutant (kg) by amount of i product (kg) and P_i is the total production of i product.

$$I_k = \frac{I_k^{\text{ins}} \cdot P_{\text{ins}} + I_k^v \cdot P_{\text{vac}} + I_k^{\text{chy}} \cdot P_{\text{chy}} + I_k^{\text{pro}} \cdot P_{\text{pro}}}{P_{\text{ins}} + P_{\text{vac}} + P_{\text{chy}} + P_{\text{pro}}} \quad (2)$$

4.3. Multicriteria genetic algorithm

4.3.1. General concepts

As mentioned earlier, real engineering design problems are usually characterized by the presence of many conflicting objectives that the design has to fulfill. Therefore, it is natural to look at the engineering design problem as a multiobjective optimization problem (MOOP). References to multiobjective optimization could be found in (Bhaskar, Gupta, & Ray, 2000; Coello, 2000; Ehrgott, 2000). As most optimization problems are multiobjective by nature, there are many methods available to tackle these types of problems.

Lately, there has been a large development of different types of multiobjective genetic algorithms, which are reflected in the literature. The big advantage of genetic algorithms over other methods, particularly over other stochastic procedures such as simulated annealing, is that a GA manipulates a population of individuals. It is therefore tempting to develop a strategy in which the population captures the whole Pareto front in one single optimization run. For an overview on genetic algorithms in multiobjective optimization, see (Fonseca & Fleming, 1995). Literature surveys and comparative studies on multiobjective genetic algorithms are also given in (Holland, 1975; Bhaskar et al., 2000; Coello, 2000). Fonseca and Fleming have divided multiobjective genetic algorithms in non-Pareto (Schaffer, 1985) and Pareto-based approaches (Goldberg, 1994).

Let us consider the multicriteria optimization problem, defined by:

$$\text{Min}\{f(x) = [f_1(x), \dots, f_k(x)], \quad \text{subject to } x \in X, \\ \text{where } X \text{ is a subset of } R^n$$

The Pareto optimal solutions can be defined as follows. A solution $x^* \in X$ is called Pareto optimal if:

$$\forall x \in X : \quad \text{either } [f_i(x) = f_i(x^*)] \forall i \in I, \text{ with } I = \{1, 2, \dots, k\} \\ \text{or } f_i(x) > f_i(x^*) \text{ even if it exists } j \in I, \text{ such that } f_j(x) < f_j(x^*)$$

In most cases, the Pareto optimal set (also called the Pareto zone) is not constituted of a single solution, but involves a set of solutions, called non dominated solutions.

Let us recall here that one intuitive way to take into account multiobjective criteria is to calculate the objective function as the weighted sum of several criteria and to solve the problem with a mono-objective genetic algorithm. This aspect was investigated at the preliminary stage of this work, with mathematical functions as test bench. Without going further in the presentation of the typical features of the multicriteria genetic algorithm

Table 1
One mathematical function used as a test bench

Problem 1	
Functions	Minimum
$f_1 = \frac{(x_1-2)^2}{2} + \frac{(x_2+1)^2}{13} + 3$	$\hat{f}_1(2; -1) = 3$
$f_2 = \frac{(x_1+x_2-3)^2}{36} + \frac{(-x_1+x_2+2)^2}{8} - 17$	$\hat{f}_2(2, 5; 0, 5) = -17$
$f_3 = \frac{(3x_1-2x_2-1)^2}{175} + \frac{(-x_1+2x_2)^2}{17} - 13$	$\hat{f}_3(0, 5; 0, 25) = -13$
$x = (x_1, x_2) \in [-4, 4]^2$	

that was finally implemented in this work, let us present some key results obtained with these two competitive approaches on a mathematical problem (see Table 1).

Fig. 4 reports the results obtained with a weighted sum method and compares those obtained with a Pareto approach (A). The results correspond to two different cases: the former is relative to equal values for the three weighting coefficients (Fig. 4C) and the latter involves a coefficient that is twice the value of the two other ones (Fig. 4D).

The use of the weighted sum method drives to a unique solution of the problem not representing the whole set of compromise solutions. To get it, it would be necessary to implement several optimization runs while modifying the relation between the weighting coefficients in order to get a bigger number of compromise solutions. This method is very penalising from a computing time point of view if a stochastic method is used, as it is the case here.

It is interesting to compare the solution obtained with an approach that consists in choosing a solution of compromise from values of the optimisation variables and not from the objective function values. Fig. 5 shows this comparison for one mathematical problem treated. It must be observed that the function optimal values are at different positions in the search space and a compromise solution chosen as the barycentre of the triangle defined by these three points places this solution outside of the Pareto optimal solution zone. The low performances of the weighted sum approach, combined with the difficult of allocating appropriate values of weighting coefficients for industrial problems are enough convincing to adopt a genetic algorithm

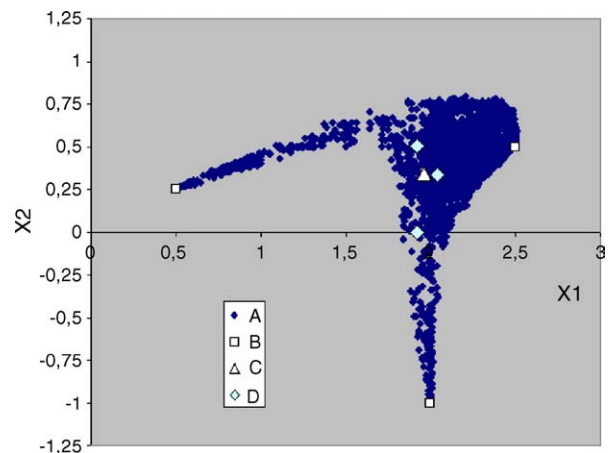

Fig. 4. Solutions obtained with the weighted sum method.

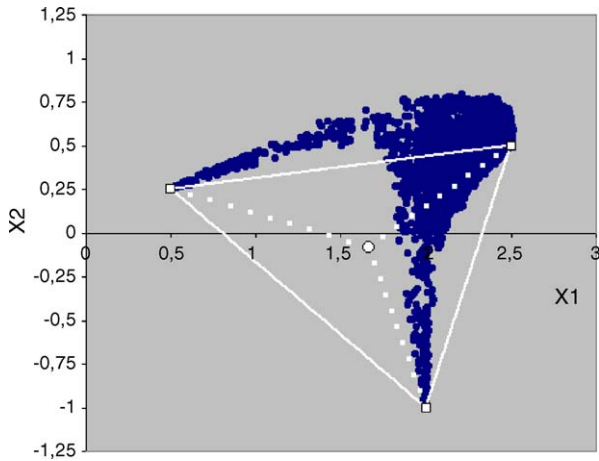

Fig. 5. Problem 1, Barycentre vs. Pareto.

with a Pareto sort to solve the problem of optimal design for batch plants.

To characterize the Pareto zone among a population of feasible solutions, following the ideas presented in (Dedieu et al., 2003) a non dominated sorting procedure, called Pareto sort (PS) was implemented and included in the multiobjective genetic algorithm (MOGA).

The option proposed by (Dedieu et al., 2003) in order to obtain the set of Pareto optimal solution, was to apply a Pareto sort procedure over the set of solutions evaluated during the GA evolution, from the initial randomly generated population, towards the final population, selecting the “good” solutions for the considered criteria.

The implementation of this framework is possible when the criteria to optimize do not have a conflicting behaviour, i.e. they have an interdependent evolution towards the optimal solution; Fig. 6a shows qualitatively this kind of behaviour. The methodology presented is then simple to implement and is able to find the set of optimal Pareto solutions.

In the case where the criteria to take into account have a strong antagonist behaviour, as it often happens in process engineering (i.e. processing time-product quality, treatment cost-environmental impact), the methodology is not able to find the whole set of Pareto optimal solutions. Fig. 6b shows

schematically the search of this method under strong antagonist behaviour criteria. Only a reduced part of the Pareto set of solutions is found around the optimal value for each optimization criterion. It is therefore necessary to propose a new genetic search based methodology that can find simultaneously “good” solutions for each criterion independently as well as a set of compromise solutions between the optimization criteria considered.

4.3.2. Presentation of the multiobjective genetic algorithm

Following these guidelines, we have then proposed to take into account the multiobjective aspects at the selection stage and the compromise solution search at the cross-over stage. The selection procedure being carried out by the biased Goldberg’s roulette, we propose to define a roulette for each criterion to optimize. An equal number of individuals for each criterion was selected to complete the total number of individual passing by the survival procedure to the next population. The cross-over procedure that proposes compromise solutions was not modified. It must be pointed that the population was composed of “good” individuals for each selected criterion thanks to the Goldberg’s roulette and that the individuals were chosen through a random procedure. This allows to cross “good” solutions for a criterion with “good” solutions for another with a strong probability to generate a compromise between both criteria. In the case that both “good” chosen solutions correspond to the same criterion, the cross-over procedure will carry out the traditional function of generating a better solution than the two previous ones. The mutation procedure is not modified and its aim is, as usual, to diversify the search and to avoid local optimum solutions.

The aim here is to propose a generic multiobjective genetic algorithm able to evolve naturally towards the whole set of optimal Pareto solution. This evolution must be done from an initial population generally randomly generated composed of individuals not adapted to the considered criteria; it is necessary to ensure that the added mechanism allows an effective way to search in the compromise zone (Fig. 6c). Two stakes are put forward: the former is simultaneous optimization of several criteria and the latter concerns the search of compromise solutions between the considered criteria.

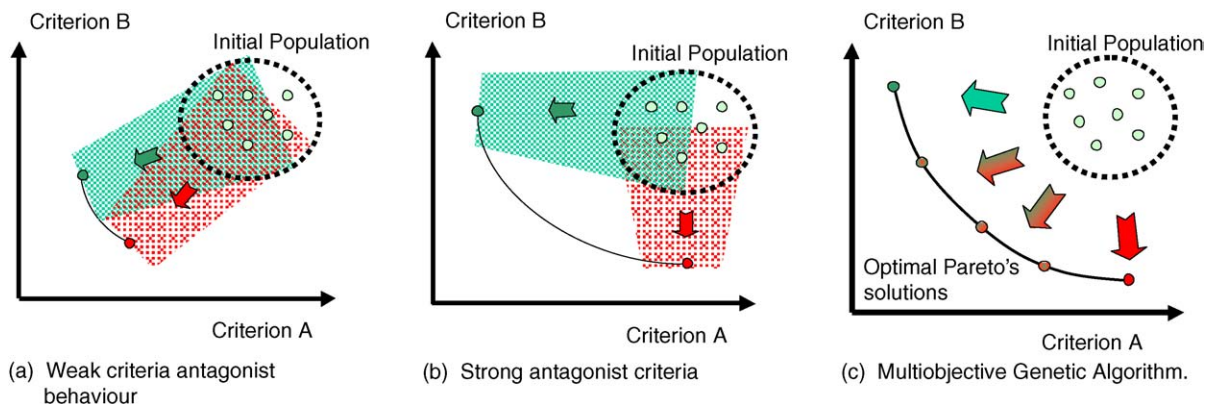

Fig. 6. Various ways to take into account multiobjective aspects.

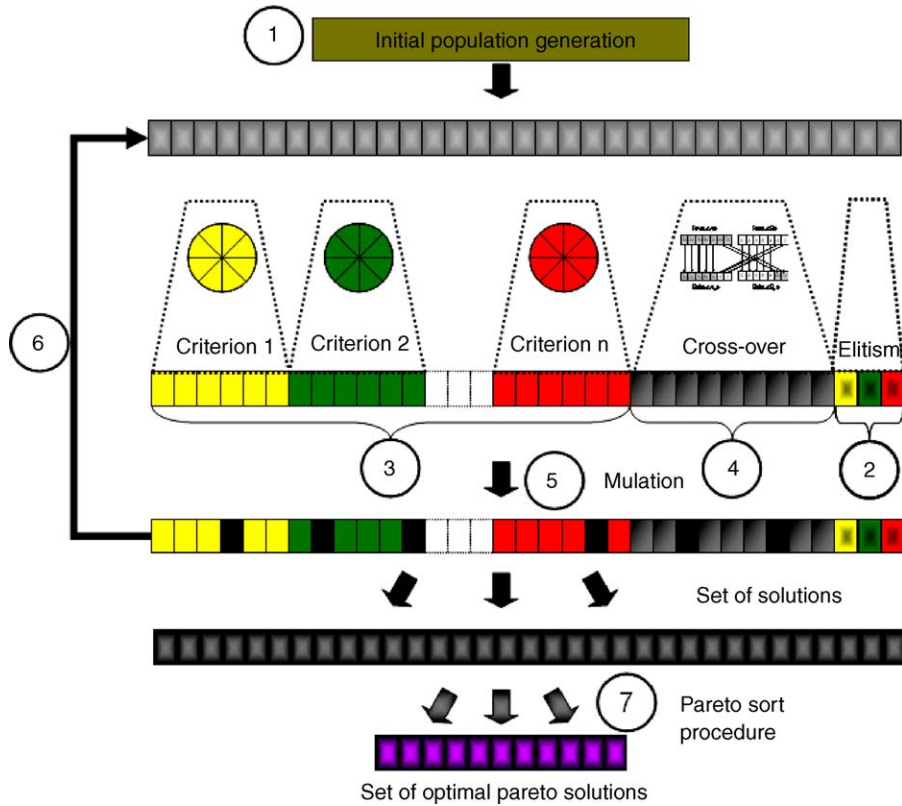

Fig. 7. Multiobjective genetic algorithm.

The MOGA developed in this study involves different procedures, as summarized in the flowchart presented in Fig. 7 that illustrates the cycle {evaluation, selection, cross-over and mutation} which is repeated until a stop criterion is reached. After this cycle, the Pareto sort is applied.

The optimization problem involves 44 variables, which may be either continuous (i.e. the operating conditions) or discrete (parallel equipment number, equipment size) (see Table 1). Let us recall that this set of variables was chosen since they have a major impact on the performance criteria used in the optimization procedure.

A binary system was chosen for encoding, as it simplifies the genetic operators, crossover and mutation. This feature is particularly interesting since it makes the GA generic enough to be adapted to other optimization problems, without chang-

ing the genetic operators, once the precision degree is specified as imposed by the physical nature of the variable. The only changes that are required concern the computation of the adaptation function, which is typical of the treated problem. These guidelines were used in other works with minor changes in the treatment of engineering problems, such as multiobjective real-time scheduling (Baez-Senties, Azzaro-Pantel, Pibouleau, & Domenech, 2005) and determination of the optimal conditions for an emulsification process (Dames, Azzaro-Pantel, & Xuereb, 2003).

A critical point in the GA development is the treatment of constraints, particularly here the respect of a time horizon. The selected strategy for initial population creation was a random chromosome generation, since the optimum position is totally unknown at the search beginning. This main advantage of this

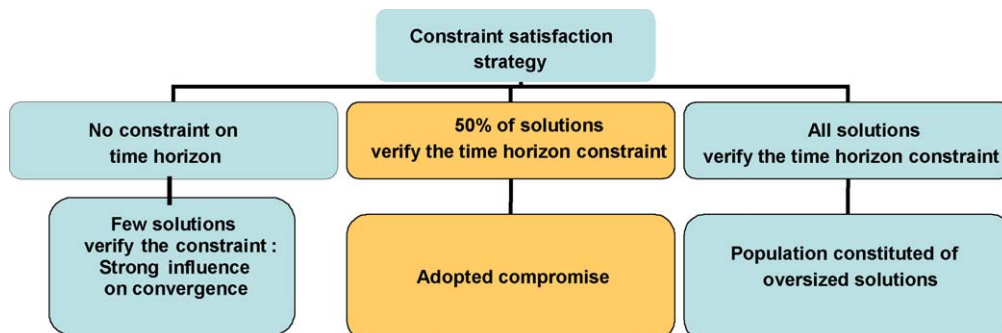

Fig. 8. Constraint satisfaction strategy.

Table 2
List of optimization variables

<p>Final concentration FER [kg/m³]</p> <p>Insuline ($C_{i,fer}$)</p> <p>Vaccine ($C_{v,fer}$)</p> <p>Chymosine ($C_{c,fer}$)</p> <p>Protease ($C_{p,fer}$)</p> <p>Final concentration MF1 [kg/m³]</p> <p>Insuline ($C_{i,mf1}$)</p> <p>Vaccine ($C_{v,mf1}$)</p> <p>Chymosine ($C_{c,mf1}$)</p> <p>Protease ($C_{p,mf1}$)</p>	<p>Water added at MF2 MF2 [m³/m³]</p> <p>Vaccine ($E_{v,mf2}$)</p> <p>Protease ($E_{p,mf2}$)</p> <p>Water added at MF1 [m³/m³]</p> <p>Insuline ($E_{i,mf1}$)</p> <p>Chymosine ($E_{c,mf1}$)</p> <p>Phase ratio at EXT [m³/m³]</p> <p>Insuline ($R_{i,extr}$)</p> <p>Vaccine ($R_{v,extr}$)</p> <p>Chymosine ($R_{c,extr}$)</p> <p>Protease ($R_{p,extr}$)</p>	<p>Equipment number []</p> <p>Storage (N_{sto})</p> <p>Fermentation (N_{fer})</p> <p>1st microfiltration (N_{mf1})</p> <p>Homogenization (N_{hom})</p> <p>2nd microfiltration (N_{mf2})</p> <p>1st ultrafiltration (N_{uf1})</p> <p>Liq.Liq. Extration (N_{ext})</p> <p>2nd ultrafiltration (N_{uf2})</p> <p>Chromatography (N_{chr})</p> <p>Filtration area [m²]</p> <p>1stmicrofiltration (S_{mf1})</p> <p>2nd microfiltration (S_{mf2})</p> <p>1st ultrafiltration (S_{uf1})</p> <p>2ndultrafiltre (S_{uf2})</p> <p>Capacity [m³/h]</p> <p>Homogenization(Cap_{hom})</p>	<p>Item volume [m³]</p> <p>Fermentation (V_{fer})</p> <p>Retentate MF1 ($V_{r,mf1}$)</p> <p>PermeateMF1 ($V_{p,mf1}$)</p> <p>Homogenization (V_{hom})</p> <p>Retentate MF2 ($V_{r,mf2}$)</p> <p>Permeate MF2 ($V_{p,mf2}$)</p> <p>Retentate UF1 ($V_{r,mf1}$)</p> <p>Liq.-Liq. extraction (V_{ext})</p> <p>Retentate UF2 ($V_{r,uf2}$)</p> <p>CHR vessel ($V_{r,chr}$)</p> <p>CHR column ($V_{c,chr}$)</p> <p>CHR column ($V_{s,sto}$)</p> <p>Pass number</p> <p>HOM []</p> <p>Vaccine ($C_{v,hom}$)</p> <p>Protease ($C_{p,hom}$)</p>
16 continuous variables		28 integer variables	
44 optimization variables			

method is to propose a diversified population. It was yet imposed that 50% of the initial population verifies the horizon constraint. For preliminary runs, this constraint was not taken into account and led to a too low number of randomly generated solutions satisfying the constraint. Consequently, the solutions that do not satisfy the given time horizon are not selected in the first phase of survival since a zero force was allocated to them. This phenomenon reduces strongly the performances of the algorithm. Secondly, it was imposed that all the individuals of the initial population verify the horizon constraint. Every generated individual contributes to the initial population, if the constraint is verified, otherwise another one is created. In this case, a conflicting behavior was observed for initial solutions, mainly constituted of oversized plants. This is why a compromise position was finally adopted. On the one hand, enough solutions verifying the constraint were generated (50%) so that the convergence of the algorithm from the first iteration is not conditioned. On the other hand, the randomly generated solutions introduce diversified solutions in the genetic inheritance, which is important for the next step of individual crossover, where no feasibility constraint is imposed (see Fig. 8).

In Table 2, all the optimization variables and their corresponding type (discrete or continuous) are listed. The continuous variables were discretized and encoded in a binary way by a variable change. In order to simplify the encoding parameters, all the continuous variables were encoded using the same bit number (eight bits). For each one, it was checked whether the discretization was accurate enough for the problem.

Concerning the discrete variables dedicated to equipment items, a typical encoding was proposed with an adequate arrangement. They were grouped by treatment stages. This means that the number of equipment items at each stage and the size of these equipment items were encoded together. The encoding method presented was developed for cases where the

equipment items are identical at a given stage. Even if it could become penalizing for the investment cost criterion when carrying out the optimal design of the batch plant, this kind of configuration is often suitable for reasons such as the maintenance of the equipment item or flexibility (any equipment item can carry out the tasks affected to another one).

Fig. 9 shows a code part used for operating stage encoding. For each stage, the number of equipment items was encoded in a binary manner (part A in Fig. 9). The number of bits attributes to this variable sets the maximum equipment item number at the stage. The equipment item of the stage is equal to the binary value plus one, to guarantee the presence of at least one equipment item at each treatment stage. This was not implemented for the storage stage because the existence of storage vessels is not necessary for product synthesis. For equipment item sizes, a number of bits equal to the available size for the equipment items was set aside (part B in Fig. 9), the chosen size having a positive value whereas zero was allocated to the other places. When equipment items are composed of several parts (i.e. the first micro filter has a retentate vessel, a permeate vessel and the filter itself, the ultrafilter has a retentate vessel and the filter itself), the same approach is repeated for each component (part B and B' in Fig. 9).

For a better understanding Fig. 10 also shows an example of a multi-part equipment item, indeed a microfilter stage. In part A, the zero represents one equipment item at the stage, as explained previously. Part B represents a retentate vessel of a

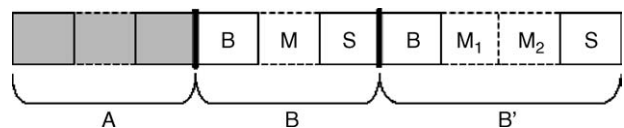

Fig. 9. Operating stage encoding method.

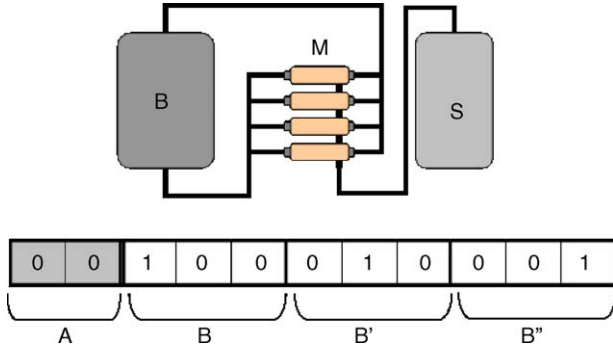

Fig. 10. Operating stage encoding example.

big size, part B' represents a medium sized filter and part B'' represents a small permeate vessel.

From the previous example, it can be observed that not any binary sequence represents systematically a treatment stage. In part B, for example, it is impossible to have the sequence 1 1 0, which would mean that the retentate vessel is both large and medium sized, at the same time. The initial procedure for the generation of population is defined by the user, so this problem can be avoided. On the other hand, the cross-over and mutation procedures of the genetic algorithm can transform chromosomes representing solutions into unrealistic representations. That is why a correction procedure is implemented to make the chromosomes representation realistic, while being careful not to bias the algorithm search. The correction procedure was presented in detail in (Dietz, 2004) and (Dietz et al., 2005) and the impact of correction on the whole mechanism was studied thoroughly, more particularly the probability of individuals to undergo a correction which will be necessary after either an infeasible crossover or mutation. To have an order of magnitude of the phenomenon, let us give here the results obtained with typical values of GA parameters. A survival rate of 70% implies that 30% of the population will be generated by crossover. The results show that 14.8% of these individuals will undergo a correction by mutation, which then involves that 4.44 % of the total population will mutate due to the correction procedure.

Concerning mutation, the analysis demonstrates that the probability of annihilating the effect of mutation due to the procedure correction is 44.4%, which is quite high. With a mutation rate of 10%, 4.4% of the total mutated population will see the effect of mutation phenomenon destroy. Globally, it must be said that the two phenomena are compensating. This is why in the experimental runs that will be further presented a lower value of the survival rate (50%) and a higher one for the mutation rate (40%) were adopted, without biasing the global search.

5. Results and discussions

In a general way the optimization problem can be presented as follows:

$$\min f_1(y), \quad \min f_2(x), \quad s.t. g(x, y) \leq H$$

Table 3
Product demands

Product	Production (kg/year)
Insulin	1500
Vaccine	1000
Chymosin	3000
Protease	6000

where, f_1 represents the investment cost and f_2 the environmental impact. Vector $x = [x_1, x_2, \dots, x_n]$ are the operating conditions and $y = [y_1, y_2, \dots, y_n]$ refers to batch plant configuration.

Minimize the investment cost, f_1 , which is function of the batch plant configuration, y , and the environmental impact, f_2 , which is function of the operating conditions, x . subject to the production constraint. The y vector (respectively x) contains respectively only discrete (respectively continuous) variables. As it was mentioned previously the environmental impact criterion was split into two objective functions but always respecting the below formulation.

From the simulation results presented in (Dietz et al., 2005), two production policies were kept, mono and multiproduct, for optimal batch plant design purposes. In the case of a mono product production policy, all the batches of a product are manufactured before treating a batch of another product. The products are manufactured alternating intra and extra cellular product, the order is as follows: insulin, vaccine, chymosin and protease. The multiproduct production policy is carried out manufacturing alternating one batch of each product in the above mentioned order.

A set of data must be fixed by the user concerning the optimization problem definition before the implementation of the design methodology. These data are presented in Tables 3–5.

In Table 3, the annual demand for each product is presented.

Table 4 presents the available range in terms of size for each equipment type. Three sizes are available for each equipment item: large (L), medium (M) and small (S). Table 4 presents the

Table 4
Available equipment item sizes

Equipment item	Large	Middle	Small
Fermenter (m ³)	6	3	1
First micro filter-retentate vessel (m ³)	6	3	1
First micro filter-filtration surface (m ²)	5	2.5	1
First micro filter-permeate vessel (m ³)	6	3	1
Homogenizer-holding vessel (m ³)	6	3	1
Homogenizer-capacity (m ³ /h)	0.5	0.25	0.1
Second micro filter-retentate vessel (m ³)	6	3	1
Second micro filter-filtration surface (m ²)	5	2.5	1
Second micro filter-permeate vessel (m ³)	6	3	1
First ultra filter-filtration surface (m ²)	50	25	10
First ultra filter-permeate vessel (m ³)	6	3	1
Liquid-liquid extractor	6	3	1
Second ultra filter-permeate vessel (m ³)	6	3	1
Second ultra filter-filtration surface (m ²)	5	2.5	1
Chromatographic separation-holding vessel	6	3	1
Chromatographic separation-column	1	0.5	0.25
Storage vessel	6	3	1

Table 5
Cost coefficients

Unit	Size	Cost
Fermenter	V_j (m ³)	63400. $V^{0.6}$
Micro- and ultrafilter	$V_{\text{retentate}}$ (m ³)	5750. $V^{0.6}$
	V_{permeate} (m ³)	5750. $V^{0.6}$
	V_{filter} (m ²)	2900. $A^{0.85}$
Homogenizer	V_{holding} (m ³)	5750. $V^{0.6}$
	Cap (m ³ /h)	12100. $\text{cap}^{0.75}$
Extractor	V_{extr} (m ³)	23100. $V^{0.65}$
	V_{holding} (m ³)	5750. $V^{0.6}$
Chromatography column	V_{chrom} (m ³)	360000. $V^{0.995}$
Storage vessel	V_{sto}	5750. $V^{0.6}$

classical expressions used for computing the investment cost of the equipment items, following a classical scaling law. Of course, a thorough economic study would also include the operating cost estimation and analysis of profitability. Since this kind of analysis only requires reliable economic data for a real process and does not induce additional difficulties in the chosen resolution strategy, a capital cost-based study was finally adopted for the preliminary economic evaluation of the project for manufacturing biological products.

Table 6 presents the lower and upper bounds for all the variables.

Table 7 displays the parameters of the genetic algorithm used for multicriteria batch plant design. In this work, the generation number was fixed as twice the population size. The global survival rate is relatively low as compared to standard values for optimization of test mathematical functions (Dedieu et al., 2003). Moreover, a high mutation rate was set as abovementioned. Although a systematic study was not carried out to find these values, they were chosen from several preliminary tests and agree with previous works (Dedieu et al., 2003) where similar problems were treated. The elitism was used in order to avoid losing the best solution for each criterion. Let us also note that typical high values for mutation rates were systematically found for batch design problems. A thorough analysis for GA parameter setting was performed by (Bernal-Haro et al., 2002) via a design of experiments analysis and showed the same trend.

Considering the stochastic aspect of GAs, several optimization runs were carried out for each multicriteria optimization. First, 20 initial populations were created and three of them were selected to limit computation time in the further steps of the algorithm, each one presenting the most favorable behavior relative to the average of one criterion considered individually.

Table 7
Genetic algorithm parameters

Parameter	Bicriteria (solvent–biomass)	Bicriteria (cost–solvent)	Bicriteria (cost–biomass)	Tricriteria (cost–EI)
Population size	300	450	450	600
Generation number	600	900	900	1200
Survival rate	0.5	0.5	0.5	0.5
Mutation rate	0.4	0.4	0.4	0.4
Elitism by criterion	1	1	1	1

Table 6
Variable bounds

Variable	Lower bound	Upper bound
$C_{x,\text{fer}}$ (kg/m ³)	35	55
$C_{v,\text{fer}}$ (kg/m ³)	35	55
$C_{c,\text{fer}}$ (kg/m ³)	35	55
$C_{p,\text{fer}}$ (kg/m ³)	35	55
$C_{i,\text{mf1}}$ (kg/m ³)	150	250
$C_{v,\text{mf1}}$ (kg/m ³)	150	250
$C_{c,\text{mf1}}$ (kg/m ³)	150	250
$C_{p,\text{mf1}}$ (kg/m ³)	150	250
$W_{i,\text{mf1}}$ (m ³ /m ³)	0.5	3.0
$W_{c,\text{mf1}}$ (m ³ /m ³)	0.5	3.0
$NP_{v,\text{hom}}$	1	3
$NP_{p,\text{hom}}$	1	3
$W_{v,\text{mf2}}$ (m ³ /m ³)	1	3
$W_{p,\text{mf2}}$ (m ³ /m ³)	1	3
$R_{i,\text{ext}}$ (m ³ /m ³)	0.05	1.5
$R_{v,\text{ext}}$ (m ³ /m ³)	0.05	1.5
$R_{c,\text{ext}}$ (m ³ /m ³)	0.05	1.5
$R_{p,\text{ext}}$ (m ³ /m ³)	0.05	1.5
N_{sto}	0	7
N_{fer}	1	8
N_{mf1}	1	8
N_{hom}	1	4
N_{mf2}	1	4
N_{uf1}	1	8
N_{ext}	1	8
N_{uf2}	1	8
N_{chr}	1	8

Given that solutions obtained in one optimization run could be dominated by solutions of another one, a Pareto sort procedure is applied to the set of solutions obtained at each optimization run, and the non-dominated solutions are considered the solutions proposed by the methodology.

In previous works (Dietz et al., 2005), a GA was applied to the same example for monocriterion batch design. The monocriterion results were presented and analyzed in detail in Dietz et al. (2005). In this work, the best solutions obtained for each criterion are used to evaluate the performance of the MOGA.

The MOGA presented in this work was first used to demonstrate that the two EI criteria considered, that are respectively the total biomass quantity and the PEG volume, present antagonist goals (Fig. 11). Very similar results were obtained at each optimization run, so only the results after the final Pareto sort procedure are presented in Fig. 11. Moreover, it must be noted that slight differences are obtained between both production policies because the environmental impact depends only on the mass balance that is function of the continuous variables.

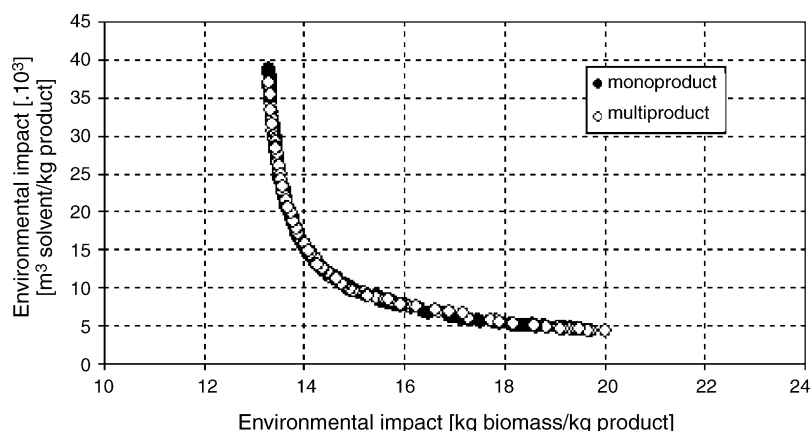

Fig. 11. Pareto's optimal solutions for biomass released–solvent amount criteria (bicriteria case).

This conflicting behavior can be explained at the liquid–liquid extraction stage. The more solvent is used, the more efficient the stage becomes and, consequently, the fewer products are lost, reducing the environmental impact index computed as kg of biomass released by kg of final product.

The same approach was also applied to the cost–environment criteria. First, the amount of solvent used and the investment cost were considered.

For illustration purposes, Fig. 12 shows the results obtained at each optimization run for the monoproduct production policy, performed with an identical parameter set to guarantee the stochastic nature of the GA. In this case, the results are not superposed as it was the case for the bicriteria optimization biomass–solvent, which show the need of carrying out several optimization runs for the same problem.

In Fig. 12, it can be seen that each optimization run is oriented to a part of the search region. The first optimization comes up with the better solution for the cost criterion, the second for the environmental criterion and the third is a compromise between both. The final Pareto sort procedure is carried out over these solutions. The final results for both production policies are presented in Fig. 13. Let us note that the Pareto zone is constituted of sparse points, since the adaptation function related to the investment cost takes discrete values.

Slight differences were found between both production policies. The antagonist behavior between these two criteria, investment cost–amount of solvent used, can be explained by a compromise between the solvent yield and the process global yield. When process yield is penalized, a bigger, and consequently more expensive, batch plant is required.

In order to evaluate the search performance of the GA, Table 8 presents the best solution obtained at each optimization run for each criteria considered as well as the best solution obtained with a monocriterion approach. Even though the methodology was not able to find the best solution, the values are relatively near (around 5% more expensive for the investment cost criterion). It must be noted that in the monocriterion optimization (see Dietz et al. (2005)), the best value was obtained only once and, in the other cases, the solutions were around 2–3% more expensive, which justifies the results when several criteria are taken into account simultaneously. The number of solutions obtained in each optimization run was around of 25. The solutions cover a large space of the explored domain, which means that there is no preferential search region in the multicriteria search as shown in Fig. 13.

It is also interesting to see where the results are placed with respect to the criterion not considered here, in this case the amount of biomass released. Table 9 presents the range of values for this criterion for both production policies.

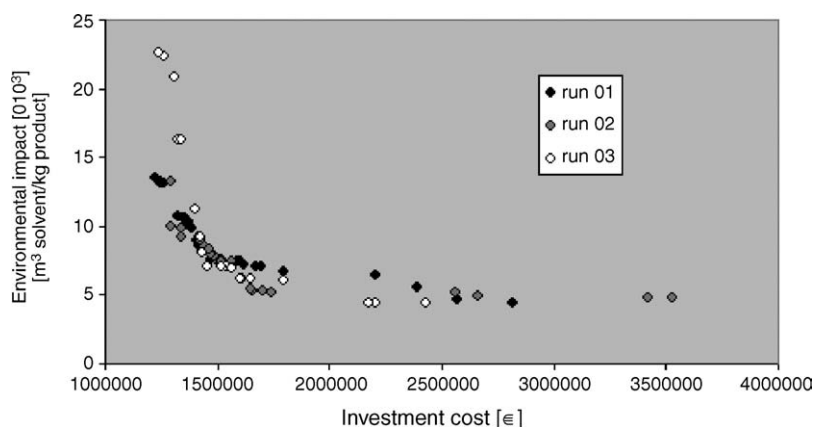

Fig. 12. Pareto's optimal solutions for solvent used–investment cost (bicriteria case).

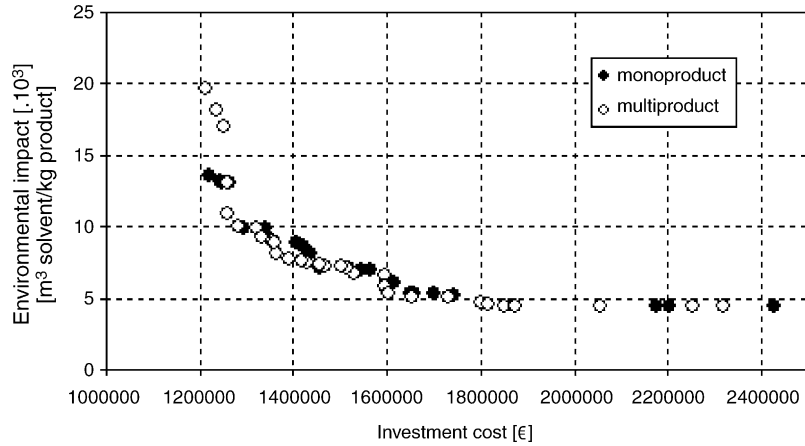

Fig. 13. Pareto's optimal solutions for solvent used–investment cost (bicriteria case).

Table 8
Bicriteria cost–solvent optimization results

	Monoproduct			Multiproduct		
	Cost (€)	Solvent (m ³ /kg product × 10 ³)	Solutions (number)	Cost (€)	Solvent (m ³ /kg product × 10 ³)	Solutions (number)
Run1	1221890	4.4451	32	1303730	5.0697	21
Run2	1290490	4.7794	23	1211100	5.0061	28
Run3	1238050	4.4146	23	1257200	4.4064	23
Best	1140990	4.3860	–	1139100	4.3860	–

They have the same order of magnitude for both production policies, exhibiting the same order of magnitude. Moreover, the minimal value of the range is close to the best value obtained in monocriterion optimization value which allows less antagonism between investment cost and biomass released criteria.

The last bicriteria optimization considers the investment cost and biomass released. As for the previous case, three optimization runs were carried out for each production policy. The results obtained after the final Pareto sort procedure are presented in Fig. 14 and are similar for both production policies as it was shown for the cost–solvent criteria.

Table 10 presents the best solution obtained at each optimization run for each considered criterion as well as the best solution obtained with a monocriterion approach. As for the criterion referring to the amount of biomass released, the best value is obtained at each optimization run, as it was the case for the amount of solvent in the previous bicriteria optimization. The number of solutions is slightly inferior to the previous results. This can be explained by the lower antagonism between the biomass and the cost criteria. As for the investment cost,

for both production policies, a better solution than the one of the monocriterion GA was found. These solutions are only 2% better than the previous ones. This shows the drawback of the stochastic optimization methods because they can not guarantee the solution optimality. On the other hand it must be noted that the GA parameters were not the same. In the case of the MOGA, a larger population was used, but at the same time it must be noted that the fact that several criteria were taken into account is not penalizing in the GA. The environmental impact criteria guide the search for batch plants with several equipment items diversifying the search paths.

Table 9 also presents the range of values for the criterion not considered, the amount of solvent used. These values are distant from the best values, which reminds the antagonism of this criterion, with respect to the other ones considered as objective functions.

The results obtained show the typical compromise between cost and each environmental index. Since the conflicting behavior between each pair of criteria (investment cost, solvent used and biomass released) was demonstrated, the final multicriteria

Table 9
Values range for the not considered criterion

	Biomass for (cost–solvent) (kg biomass/kg product)		Solvent for (cost–biomass) (m ³ /kg product × 10 ³)	
	Minimum	Maximum	Minimum	Maximum
Monoproduct	14.39	20.37	36×10^{-3}	40.58×10^{-3}
Multiproduct	14.26	22.89	35×10^{-3}	41.88×10^{-3}

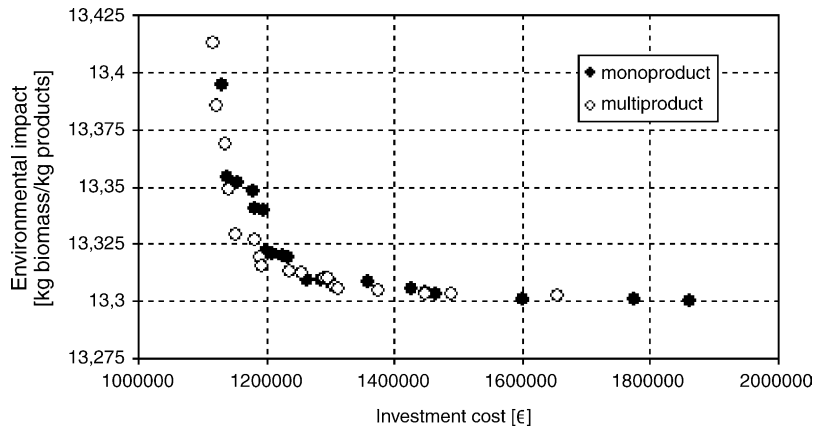

Fig. 14. Pareto's optimal solutions for biomass released–investment cost (bicriteria case).

Table 10
Bicriteria cost–biomass optimization results

	Monoproduct			Multiproduct		
	Cost (€)	Biomass (kg biomass/kg product)	Solutions (number)	Cost (€)	Biomass (kg biomass/kg product)	Solutions (number)
Run1	1143080	13.303	10	1252280	13.307	15
Run2	1235340	13.300	10	1289530	13.303	13
Run3	1129290	13.305	15	1116950	13.302	22
Best	1140990	13.299	–	1139100	13.305	–

Table 11
Multicriteria cost–environmental impact results

	Monoproduct			Multiproduct		
	Cost (€)	Solvent (m ³ /kg product × 10 ³)	Biomass (kg biomass/kg product)	Cost (€)	Solvent (m ³ /kg product × 10 ³)	Biomass (kg biomass/kg product)
Run1	1232630	4.4378	13.303	1130860	4.3935	13.3003
Run2	1207900	4.4214	13.304	1265100	4.4470	13.3034
Run3	1279110	4.3909	13.304	1124630	4.4588	13.3014

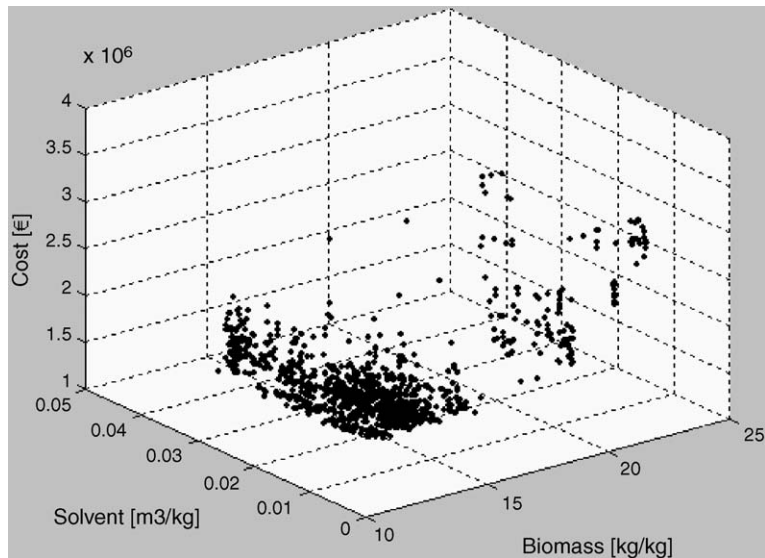

Fig. 15. Pareto's optimal solutions cost–IE (tricriteria case).

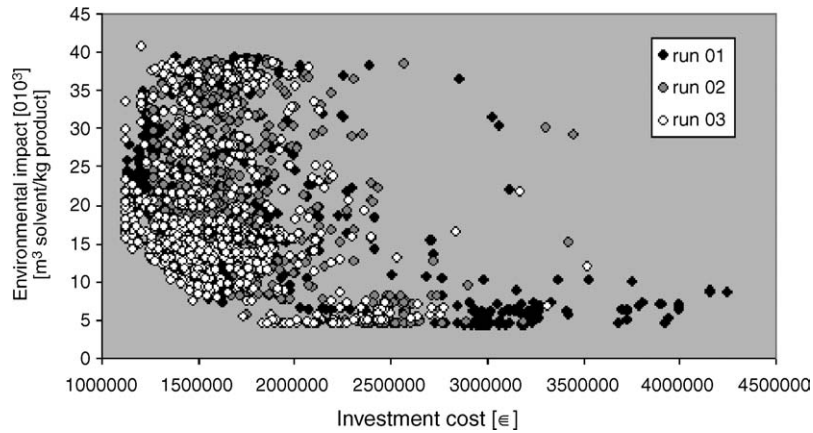

Fig. 16. Pareto's optimal solutions Cost-solvent (tricriteria case).

cost-environment batch plant design was carried out, keeping the two environmental criteria independent: this simply means that the same survival rate was considered for each criterion.

As for the previous optimizations, the three optimization runs (following the same population creation procedure) were carried out for each production policy. Given the similarity of the results with both production policies (see Table 11), only the results obtained with a multiproduct production policy are presented (Fig. 15).

It can be observed that most solutions referring to the previous bi-criteria optimization are found again. In all three cases, the points are more concentrated near the compromise zone, which is interesting for final decision. In order to evaluate the methodology, Figs. 16 and 17 show the results projected for each optimization run. In this case, we observe that several optimization runs are necessary, given the complexity of considering a third criterion; the results are not systematically superposed as for the bicriteria case study. Two options could be considered for improvement, larger population and generation number and some extra optimization runs.

Table 11 presents the best solution for each criterion for both production policies. As it was mentioned, there are only slight differences between both production policies. It also shows that the monocriterion search is not penalized by the multicriteria

one. In other words, the same GA is able to carry out both of them, even when several antagonist objective functions are considered.

6. Conclusions and perspectives

A methodology has been proposed for batch plant design, considering both investment cost and environmental impact minimization. An optimization scheme has been implemented using a multiobjective genetic algorithm with a Pareto optimal ranking method. This technique is ideally suited to this type of problem, where a number of conflicting considerations must be taken into account. The use of MOGA enables a robust optimization technique, across a non-linear search space (the objective functions are computed by the use of a discrete-event simulator (DES) integrating shortcut unit operations models) linking multiple variables and objectives.

The paper clearly shows that opportunities for process optimization and environmental impact minimization must be considered at the early stages of process development before the process is frozen due to regulatory reasons.

Current works are now carried out on a modified version of the DES, giving more operational flexibility to the batch plant through the campaign policies and including new

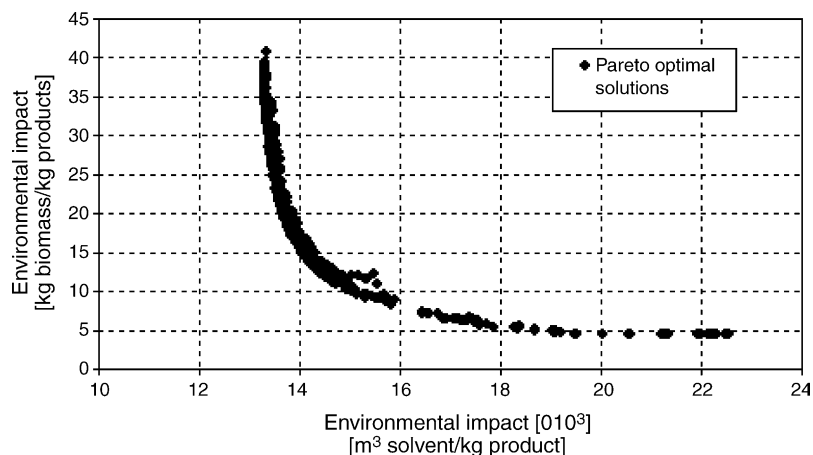

Fig. 17. Pareto's optimal solutions Cost-solvent (tricriteria case).

optimization criteria, reflecting the advance or delay of the production.

It is important to note that optimization was performed without any preference information, which means that the Pareto-optimal set consists of all solutions according to any rational decision-maker. Here the search for an optimal set of solutions is separated from the final decision. The decision-maker is presented with a set of solutions from which he has to choose, and the hypothesis is that when the trade-off between the objectives is visible it would be easier to choose. However, this might not hold as the number of objectives increases and visualization becomes harder. This is an interesting field for further research: a decision making tool, taking into account various weights on criteria, reflecting the preferences of the decision maker, may be integrated to the current framework in order to rank the obtained solutions.

References

- Asenjo, A., Montagna, J. M., Vecchiotti, A. R., Iribarren, O. A., & Pinto, J. M. (2000). Strategies for the simultaneous optimization of the structure and process variables of a protein production plant. *Computers and Chemical Engineering*, 24, 2277–2290.
- Baez-Senties, O., Azzaro-Pantel, C., Pibouleau, L., & Domenech, S. (2005). Aide à la décision pour la supervision d'un atelier discontinu: Application à la fabrication de composants électroniques. In *Proceedings of the SFGP*.
- Bérard, F., Azzaro-Pantel, C., Pibouleau, L., Domenech, S., Navarre, D., & Pantel, M. (1999). Towards an incremental development of discrete-event simulators for batch plants: Use of object-oriented concepts, Comm. Escape 9, Budapest. *Computers and Chemical Engineering*, (Supplements), S565–S568.
- Bernal-Haro, L., Azzaro-Pantel, C., Pibouleau, L., & Domenech, S. (2002). Multiobjective batch plant design: A two-stage methodology. 1. Development of a genetic algorithm and result analysis. *Industrial and Engineering Chemistry Research*, 41, 5743–5758.
- Bhaskar, V., Gupta, S. K., & Ray, A. K. (2000). Applications of multiobjective optimization in chemical engineering. *Reviews in Chemical Engineering*, 16.
- Burgess, A. A., & Brennan, D. J. (1999). The application of life cycle assessment to process optimization. *Computers and Chemical Engineering*, 23, 1509–1526.
- Cabezas, H., Bare, J. C., & Mallick, S. K. (1999). Pollution prevention with chemical process simulators: The generalized waste reduction (WAR) algorithm-full version. *Computers and Chemical Engineering*, 23(4–5), 623–634.
- Cao, De-Ming, & Yuan, Xi-Gang. (2002). Optimal design of batch plants with uncertain demands considering switch over of operating modes of parallel units. *Industrial and Engineering Chemistry Research*, 41(18), 4616–4625.
- Cavin, L., Fischer, U., Glover, F., & Hungerbühler, K. (2004). Multi-objective process design in multi-purpose batch plants using a Tabu search optimization algorithm. *Computers and Chemical Engineering*, 28(4), 459–478.
- Chakraborty, A., Malcolm, A., Colberg, R. D., & Linninger, A. (2004). Optimal waste reduction and investment planning under uncertainty. *Computers and Chemical Engineering*, 28(6–7), 1145–1156.
- Chunfeng, W., & Xin, Z. (2002). Ants foraging mechanism in the design of multiproduct batch chemical process. *Industrial and Engineering Chemistry Research*, 41(26), 6678–6686.
- Coello, A. C. (2000). An updated survey of GA-based multiobjective optimization techniques. *ACM Computing Survey*, 32, 109–143.
- Colomi, A., Dorizo, M., & Manniezzo, V. (1991). Distributed optimization by ant colonies. In *Proceedings of the European Conference on Artificial Life ECAL 91* (p. 134).
- Dames, M., Azzaro-Pantel, C., Xuereb, C., 2003. Optimization de la qualité d'une émulsion par couplage de techniques réseau de neurones et algorithme génétique. In *SFGP03 Proceedings CD Rom*, ISBN 2-910239-64-0, September 2003.
- Dedieu, S., Pibouleau, L., Azzaro-Pantel, C., & Domenech, S. (2003). Design and retrofit of multiobjective batch plants via a multicriteria genetic algorithm. *Computers and Chemical Engineering*, 27, 1723–1740.
- Dietz, A., 2004. Multicriteria optimisation for multiproduct batch plant design under economic and environmental considerations, PhD Thesis. INPT. December.
- Dietz, A., Azzaro-Pantel, C., Pibouleau, S., & Domenech, S. (2005). A Framework for multiproduct batch plant design with environmental consideration: application to protein production. *Industrial and Engineering Chemistry Research*, 44, 2191–2206.
- Ehrgott, M. (2000). *Lecture notes in economics and mathematical systems—multicriteria optimization*. Berlin Heidelberg: Springer-Verlag.
- Fonseca, C., & Fleming, P. (1995). An overview of evolutionary algorithms in multiobjective optimization. *Evolutionary Computation*, 3, 1–18.
- Goel Harish, D., Weijnen Margot, P. C., & Grievink Johan. (2004). Optimal reliable retrofit design of multiproduct batch plants. *Industrial and Engineering Chemistry Research*, 43(14), 3799–3811.
- Goldberg, D. A. (1994). *Algorithmes génétiques*. MA: Addison-Wesley.
- Heo, S.-K., Lee, K.-H., Lee, H.-K., Lee, I.-B., & Park, J. H. (2003). A new algorithm for cyclic scheduling and design of multipurpose batch plants. *Industrial and Engineering Chemistry Research*, 42(4), 836–846.
- Holland, J. H. (1975). *Adaptation in natural and artificial systems*. Ann Arbor, MI: University of Michigan Press.
- Kirkpatrick, S., Gelatt, C. D., & Vecchi, M. P. (1983). Optimization by simulated annealing. *Science*, 220, 671–680.
- Montagna, J. M. (2003). The optimal retrofit of multiproduct batch plants. *Computers and Chemical Engineering*, 27(8–9), 1277–1290.
- Montagna, J. M., Vecchiotti, A. R., & Iribarren, O. A. (2000). Optimal design of protein production plants with time and size factor process models. *Biotechnology Progress*, 16, 228–237.
- Pibouleau, L., Floquet, P., Domenech, S., & Azzaro-Pantel, C. (1999). A survey of optimization tools through ESCAPE symposia, Comm. Escape 9, Budapest. *Computers and Chemical Engineering*, (Supplements), S495–S498.
- Pinto, T., Barbosa-Póvoa, A. P., & Novais, A. Q. (2005). Optimal design and retrofit of batch plants with a periodic mode of operation. *Computers and Chemical Engineering*, 29(6), 1293–1303.
- Pinto, J. M., Montagna, J. M., Vecchiotti, A. R., Iribarren, O. A., & Asenjo, J. A. (2001). Process performance models in the optimization of multiproduct protein production plants. *Biotechnology and Bioengineering*, 74(6), 451–465.
- Schaffer, J. (1985). Multiple objective optimization with vector evaluated genetic algorithms. In *Genetic algorithms and their applications: Proceedings of the first international conference on genetic algorithms* (pp. 93–100).
- Stefanis, S. K., Livingston, A. G., & Pistikopoulos, E. N. (1995). Minimizing the environmental impact of process plants: A process systems methodology. *Computers and Chemical Engineering*, 19(1), 39–44.