



HAL
open science

On two variations of identifying codes

Olivier Delmas, Sylvain Gravier, Mickael Montassier, Aline Parreau

► **To cite this version:**

Olivier Delmas, Sylvain Gravier, Mickael Montassier, Aline Parreau. On two variations of identifying codes. *Discrete Mathematics*, 2011, 311 (17), pp.1948-1956. 10.1016/j.disc.2011.05.018 . hal-00475625v2

HAL Id: hal-00475625

<https://hal.science/hal-00475625v2>

Submitted on 17 Jun 2011

HAL is a multi-disciplinary open access archive for the deposit and dissemination of scientific research documents, whether they are published or not. The documents may come from teaching and research institutions in France or abroad, or from public or private research centers.

L'archive ouverte pluridisciplinaire **HAL**, est destinée au dépôt et à la diffusion de documents scientifiques de niveau recherche, publiés ou non, émanant des établissements d'enseignement et de recherche français ou étrangers, des laboratoires publics ou privés.

On two variations of identifying codes[☆]

Olivier Delmas^a, Sylvain Gravier^b, Mickael Montassier^a, Aline Parreau^b

^aUniversité de Bordeaux, LaBRI, 351 cours de la Libération, 33400 Talence, France

^bInstitut Fourier (UMR 5582), 100 rue des Maths, BP 74, 38402 Saint-Martin d'Hères, France

Abstract

Identifying codes have been introduced in 1998 to model fault-detection in multiprocessor systems. In this paper, we introduce two variations of identifying codes: weak codes and light codes. They correspond to fault-detection by successive rounds. We give exact bounds for those two definitions for the family of cycles.

Keywords: identifying codes, cycles, metric basis

1. Introduction

Identifying codes are dominating sets having the property that any two vertices of the graph have distinct neighborhoods within the identifying code. Also, they can be used to uniquely identify or locate the vertices of a graph. Identifying codes have been introduced in 1998 in [11] to model fault-detection in multiprocessor systems. Numerous papers already deal with identifying codes (see *e.g.* [13] for an up-to-date bibliography). A multiprocessor system can be modeled as a graph where vertices are processors and edges are links between processors. Assume now that at most one of the processors is defective, we would like to locate it by testing the system. For this purpose, we select some processors (constituting the code) and have them test their r -neighborhoods (*i.e.* the processors at distance at most r). The processor sends an alarm if it detects a fault in its neighborhood. We require that we can, with these answers, tell if there is a faulty processor and, in this case, locate it uniquely. This corresponds exactly to finding an identifying r -code of the graph of the system.

Assume now that a processor can restrict its tests to its i -neighborhood for $i \in \llbracket 0, r \rrbracket$. Then, we can have a detection process by rounds: at the first step, the selected processors test their 0-neighborhoods, then they test their 1-neighborhoods, \dots , until the r -neighborhoods. We stop the process when we can locate the faulty processor. We introduce in this paper *weak r -codes* (*resp.* *light r -codes*) that will model this process without memory, *i.e.* to identify a faulty processor at the round i , the supervisor does not need to remember the collected information of the rounds $j < i$ (*resp.* with memory, *i.e.* to identify a faulty processor at the round i , the supervisor needs to remember the collected information of the rounds $j < i$) and study them for the family of cycles.

Let us give some notations and definitions. We denote by $G = (V, E)$ a simple non oriented graph having vertex set V and edge set E . Let x and y be two vertices of G . The *distance* $d(x, y)$ between x and y is the number of edges of a shortest path between x and y . Let r be an integer. The *ball* centered on x of radius r , denoted by $B_r(x)$ is defined by $B_r(x) = \{y \in V \mid d(x, y) \leq r\}$.

An *r -dominating set* of G is a subset $C \subseteq V$ such that $\cup_{c \in C} B_r(c) = V$. This means that each vertex of G is at distance at most r of a vertex of C . We say that a subset $C \subseteq V$ *r -separates* x and y if and only if $B_r(x) \cap C \neq B_r(y) \cap C$ (we will also say in this case that “ x and y are separated by C for radius r ” or that “ x is separated from y by C for radius r ”). A set C *r -identifies* x if and only if it r -separates x from all the other vertices.

[☆]This research is supported by the ANR Project IDEA • Identifying codes in Evolving graphs • ANR-08-EMER-007, 2009-2011.
Email address: aline.parreau@ujf-grenoble.fr (Aline Parreau)

(1) Identifying r -code. An *identifying r -code* of G is an r -dominating set $C \subseteq V$ that r -identifies all the vertices:

$$\forall x \in V, \forall y \neq x \in V, B_r(x) \cap C \neq B_r(y) \cap C$$

(2) Weak r -code. A *weak r -code* of G is a r -dominating set $C \subseteq V$ such that each vertex x is r_x -identified by C for some radius $r_x \in \llbracket 0, r \rrbracket$:

$$\forall x \in V, \exists r_x \in \llbracket 0, r \rrbracket, s.t. \forall y \neq x \in V, B_{r_x}(x) \cap C \neq B_{r_x}(y) \cap C$$

(3) Light r -code. A *light r -code* of G is a r -dominating set $C \subseteq V$ such that each pair (x, y) of vertices is r_{xy} -separated by C for some radius $r_{xy} \in \llbracket 0, r \rrbracket$:

$$\forall x \in V, \forall y \neq x \in V, \exists r_{xy} \in \llbracket 0, r \rrbracket, s.t. B_{r_{xy}}(x) \cap C \neq B_{r_{xy}}(y) \cap C$$

Figure 1 gives an example of a weak 2-code of P_5 (elements of the code are in black, as in all the figures). Indeed, vertices v_3 and v_4 are identified for radius 0, vertices v_2 and v_5 are identified for radius 1 and vertex v_1 is identified for radius 2. But this code is not an identifying 2-code of P_5 : vertices v_2, v_3, v_4 and v_5 are not separated for radius 2. Figure 2 gives a light 2-code of P_5 which is not a weak 2-code: vertex v_2 is separated from vertex v_1 only for radius 0 and for this radius, vertex v_2 is not separated from v_3 .

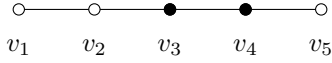

Figure 1: A weak 2-code that is not an identifying 2-code

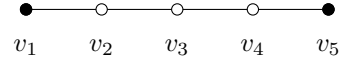

Figure 2: A light 2-code that is not a weak 2-code

A code C is said to be *optimum* if its cardinality is minimum. We denote by $IC_r(G)$ (*resp.* $WC_r(G)$, $LC_r(G)$) the cardinality of an optimum identifying (*resp.* weak, light) r -code. An identifying r -code is a weak r -code and a weak r -code is a light r -code. This implies the following inequality: $IC_r(G) \geq WC_r(G) \geq LC_r(G)$. For all graphs and for any r , there exists a weak r -code and a light r -code (using for instance all the vertices as the code), whereas this is not true for identifying codes.

Let us now give some bounds for weak codes.

Theorem 1. *Let r and k be two integers and $w_r(k)$ be the maximum order of a graph G such that G has a weak r -code of size k . We have:*

$$w_r(k) = k + r(2^k - 2)$$

Proof

First, we construct a graph H_r^k in the following way (see Figure 3 for $r = 4$ and $k = 3$). The graph H_r^k has vertex set $C \cup I_1 \cup \dots \cup I_r$ where $C = \{1, \dots, k\}$ and I_j has size $2^k - 2$ for $1 \leq j \leq r$. Each vertex of I_j corresponds to a non-empty strict subset of $\{1, \dots, k\}$. Each vertex of I_1 is linked to the vertices of C that form its subset, and each vertex of I_j for $j > 1$ is linked to the vertex of I_{j-1} that corresponds to the same subset. Furthermore, C induce a clique in H_r^k . The graph H_r^k has order $k + r(2^k - 2)$ and one can check that C is a weak r -code of H_r^k (a vertex of I_j is identified for radius j). So $w_r(k) \geq k + r(2^k - 2)$.

Now let G be a graph and C be a weak r -code size k of G . Let us try to maximize the number of identified vertices for each radius $i \leq r$.

- For radius 0, only the k vertices of C can be identified.
- For radius 1, at most 2^k additional vertices can be identified (one for each subset of C). However, it is not possible to have all the subsets. Indeed, all the elements of $\{B_1(c) \cap C \mid c \in C\}$ cannot be used to identify a vertex not in C for radius 1. If $2^k - 1$ additional vertices are identified at radius 1, that means that $\{B_1(c) \cap C \mid c \in C\}$ contains only one element, which is necessarily the whole set C . Then all the strict subsets of $\{1, \dots, k\}$ are used

to identify a vertex for radius 1, in particular, one vertex is identified by the emptyset and so is not 1-dominated by C . As the set C must be an r -dominating set, then $r \geq 2$. Furthermore, if we try to add a new vertex x in G , then necessarily, $B_1(x) \cap C = C$ and x will not be identified for any radius. So, G has order $k + (2^k - 1)$ and $r \geq 2$. A contradiction with the bound $w_r(k) \geq k + 2(2^k - 2)$ for $r \geq 2$, given by the construction of the graph H_2^k . It follows that at most $2^k - 2$ additional vertices are identified for radius 1 in G .

- For radius $2 \leq i \leq r$, using a similar process, we can show that at most $2^k - 2$ vertices are identified at round i .

Summing the number of identified vertices at each round, we obtain that G has order at most $k + r(2^k - 2)$. It follows that $w_r(k) = k + r(2^k - 2)$. □

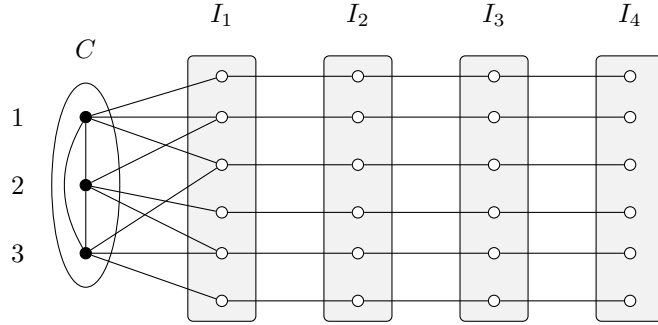

Figure 3: The graph H_4^3 – Extremal case for a graph with a weak 4-code of size 3

Light r -codes are related to other locating notions: a *light 1-code* is a *1-locating dominating code* [7] for which we require that only pairs of vertices not in the code are 1-separated by C . The notion of light r -codes is a generalization of the notion of metric basis. A subset C of vertices is a *metric basis* if every pair of vertices of the graph is separated by a vertex of C for some radius (there is no bound on the radius). The *metric dimension* of a graph G , denoted by $\dim(G)$, is the cardinal of a minimum metric basis. A light r -code is a metric basis, so $LC_r(G) \geq \dim(G)$. If r is greater than the diameter of G , i.e. the largest distance between two vertices of G , then a light r -code is exactly a metric basis. For a detailed review about metric basis, see [6]. As for metric basis, we do not have good bounds of the extremal size of a graph that has light r -codes of size k .

The optimization problems of finding optimum identifying codes [5] and optimum metric bases [12] are NP-complete. Finding optimum light codes is also NP-complete because if r is larger than the diameter of the graph, then it is equivalent to metric bases. Therefore, identifying codes and metric bases have been studied in particular classes of graphs (see e.g. [2, 3, 4, 9]).

For cycles, although metric bases problem in cycles is not difficult (the dimension of a cycle is 2), the case of identifying codes is not as easy: the complete study of cycles has just been finished in [10] after numerous contributions (see e.g. [1, 8, 14]). We focus on the case of weak and light r -codes.

In this paper, we give exact value for WC_r (Section 2) and LC_r (Section 3) for the class of cycles. In weak codes, we assign a radius to each vertex to separate it from other vertices whereas we can assign up to $r + 1$ radii to a vertex with light r -codes. We show that 3 radii per vertex is actually sufficient to separate it from all the other vertices. We address in Section 4 the question of the optimum size of a code requiring only 2 stored radii per vertex.

2. Weak r -codes of cycles

In the following, we will denote by C_n the cycle of size n and by $\{v_0, v_1, \dots, v_{n-1}\}$ the set of its vertices. We first assume that $n \geq 2r + 2$.

Lemma 1. *Let S be a set of $2r + 2$ consecutive vertices on \mathcal{C}_n . If C is a weak r -code of \mathcal{C}_n , then S contains at least two elements of C .*

Proof

Without loss of generality, $S = \{v_0, v_1, \dots, v_{2r+1}\}$. Assume S contains a single element of the code, say $a = v_i$, w.l.o.g. $i \leq r$ (see Figure 4).

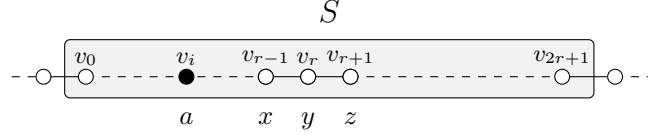

Figure 4: Notation of the proof (Lemma 1)

We focus on the vertices $x = v_{r-1}$, $y = v_r$ and $z = v_{r+1}$. Then, $B_r(y) \subseteq S$ and $B_r(z) \subseteq S$. Let $t = d(a, y) = r - i$.

For all $r' \in \llbracket 0, t-1 \rrbracket$, $B_{r'}(y) \cap C = B_{r'}(z) \cap C = \emptyset$. For all $r' \in \llbracket t+1, r \rrbracket$, $B_{r'}(y) \cap C = B_{r'}(z) \cap C = \{a\}$. Hence $r_y = r_z = t$. It follows that $B_t(y) \cap C = \{a\}$ must be different from $B_t(x) \cap C$. Hence, $B_t(x) \cap C$ must contain an element different from a , say b . Necessarily, $b \notin S$, this implies $t = r$ and z is not r -dominated, a contradiction. \square

A first bound of $WC_r(\mathcal{C}_n)$ directly follows from Lemma 1:

Corollary 1. *Let C be a weak r -code of \mathcal{C}_n . Then $|C| \geq \lceil n/(r+1) \rceil$.*

Proof

In \mathcal{C}_n there are n different sets S of $2r + 2$ consecutive vertices. If C is a weak r -code, by Lemma 1, there are at least 2 vertices of the code in each set S . Each vertex of the code is counted exactly $2r + 2$ times, so $|C| \geq \lceil 2n/(2r+2) \rceil = \lceil n/(r+1) \rceil$. \square

In the following, we set $n = (2r + 2)p + R$, with $0 \leq R \leq 2r + 1$ and $p \geq 1$ (by assumption, $n \geq 2r + 2$). Then Corollary 1 can be reformulated as: if C is a weak r -code of \mathcal{C}_n , then we have

- if $R = 0$, then $|C| \geq 2p$;
- if $1 \leq R \leq r + 1$, then $|C| \geq 2p + 1$;
- if $r + 2 \leq R \leq 2r + 1$, then $|C| \geq 2p + 2$.

Lemmas 2 to 4 give some constructive upper bounds. Moreover, Lemmas 2 to 5 provides exact values of $WC_r(\mathcal{C}_n)$.

Lemma 2. *If $n = (2r + 2)p$, then \mathcal{C}_n has a weak r -code with cardinality $2p = n/(r+1)$; moreover, this code is optimum.*

Proof

We construct the code by repeating the pattern depicted by Figure 5. More precisely, let $C = \{v_i \mid i \equiv r \pmod{2r+2} \text{ or } i \equiv r+1 \pmod{2r+2}\}$. The set C has cardinality $2p$. The set C r -dominates all the vertices of \mathcal{C}_n . Let $r_{v_k} = r - k$ if $k \in \llbracket 0, r \rrbracket$ and $r_{v_k} = k - (r + 1)$ if $k \in \llbracket r + 1, 2r + 1 \rrbracket$ (the indices of the vertices of \mathcal{C}_n are taken modulo $2r + 2$). Then for all pair of vertices v_k, v_l , $k \neq l$, we have $B_{r_{v_k}}(v_k) \cap C \neq B_{r_{v_k}}(v_l) \cap C$. Hence C is an r -dominating set that r_{v_k} -identifies the vertex v_k . It follows that C is a weak r -code. This code is optimum by Corollary 1. Figure 6 gives an example of such a code in \mathcal{C}_{12} . \square

We can easily extend this construction to the general case:

Lemma 3. *If $R = 1$, then \mathcal{C}_n has a weak r -code with $2p + 1$ elements. If $2 \leq R \leq 2r + 1$, then \mathcal{C}_n has a weak r -code with $2p + 2$ elements. These codes are optimum for $R = 1$ or $R \geq r + 2$.*

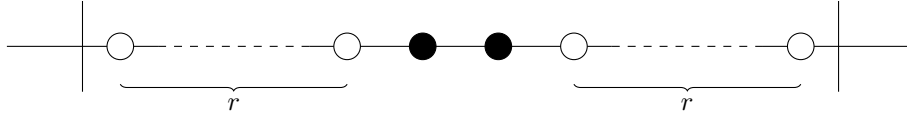

Figure 5: The pattern for a weak r -code in the cycles $\mathcal{C}_{(2r+2)p}$ with $p \geq 1$

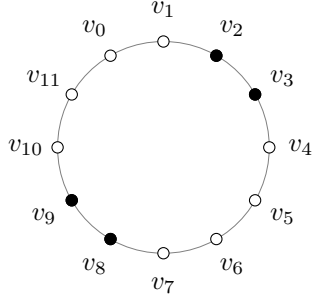

Figure 6: An optimum weak 2-code of \mathcal{C}_{12}

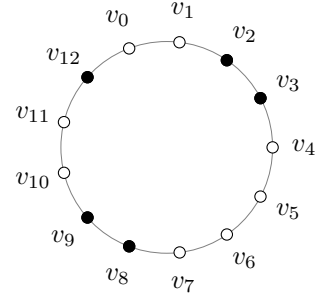

Figure 7: An optimum weak 2-code of \mathcal{C}_{13}

Proof

Let $R = 1$ and $C = \{v_i \mid i \equiv r \ [2r + 2] \text{ or } i \equiv r + 1 \ [2r + 2]\} \cup \{v_{n-1}\}$. Then C is a weak r -code of \mathcal{C}_n and $|C| = 2p + 1$. (See Figure 7.)

Assume now that $R \geq 1$ and take for code $C = \{v_i \mid i \equiv r[2r + 2] \text{ or } i \equiv r + 1[2r + 2]\}$ if $R \geq r + 2$ and $C = \{v_i \mid i \equiv r[2r + 2] \text{ or } i \equiv r + 1[2r + 2]\} \cup \{v_{n-2}, v_{n-1}\}$ otherwise. Then C is a weak r -code of \mathcal{C}_n . \square

In some cases, the aforementioned codes are not optimum:

Lemma 4. *If $(r, R) = (1, 2)$, then \mathcal{C}_n has an optimum weak 1-code of cardinality $2p + 1$. If $(r, R) = (2, 2)$, then \mathcal{C}_n has an optimum weak 2-code of cardinality $2p + 1$.*

Figure 8 (*resp.* Figure 9) shows an example of an optimum weak r -code for $(r, R) = (1, 2)$ (*resp.* $(r, R) = (2, 2)$).

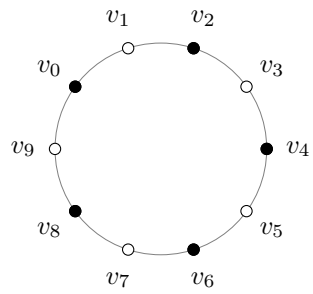

Figure 8: An optimum weak 1-code of \mathcal{C}_{10}

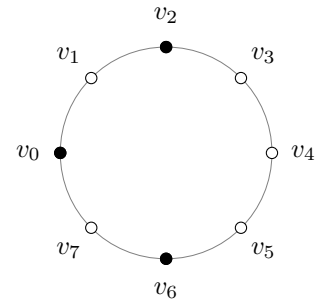

Figure 9: An optimum weak 2-code of \mathcal{C}_8

Proof

For $(r, R) = (1, 2)$, the set $C = \{v_i \mid i \equiv 0[2]\}$ is a weak 1-code: each vertex x in the code is 0-identified by C and each vertex x not in the code is 1-identified by C . For $(r, R) = (2, 2)$, the set $C = \{v_i \mid i \equiv 0 \ [6] \text{ or } i \equiv 2 \ [6]\}$ is a weak 2-code. The optimality of these codes is shown by Corollary 1. \square

The next lemma shows that the lower bound of Corollary 1 is not sharp for $2 \leq R \leq r + 1$ and $(r, R) \neq (1, 2)$ or $(2, 2)$, this implies that in these cases, codes of Lemma 3 are optimum.

Lemma 5. *If $2 \leq R \leq r + 1$ and $(r, R) \neq (1, 2)$ or $(2, 2)$, then \mathcal{C}_n does not have a weak r -code of cardinality $2p + 1$.*

Proof

Assume that there is a weak r -code C of \mathcal{C}_n of cardinality $2p + 1$. First, observe:

(O.1) In a set of R consecutive vertices of \mathcal{C}_n , there must be at most one vertex of C . Otherwise, in the rest of \mathcal{C}_n , there are at most $2p - 1$ vertices of the code in a set of $(2r + 2)p$ consecutive vertices which contradicts Lemma 1. In particular there is no pair of consecutive vertices of C .

(O.2) For similar reasons, in a set of $2r + 2 + R$ consecutive vertices of \mathcal{C}_n , there must be at most 3 vertices of C .

Let M be the maximum size of a set of consecutive vertices not in C and let S_M be a set of M consecutive vertices not in C . We know by (O.1) that $M \geq R - 1$. Moreover $M > 1$; indeed, if $M = 1$, then $R = 2$ and the code is exactly one vertex over 2, so $|C| = \frac{n}{2} = 2p + 1$, $n = 4p + 2$ and $(r, R) = (1, 2)$.

Let us denote c_1 and c_2 the two elements of the code bounding S_M , let S_1 and S_2 be the two maximal sets of consecutive vertices not in C who are before c_1 and after c_2 , and finally c_0 and c_3 the two vertices of the code who are before S_1 and after S_2 (see Figure 10).

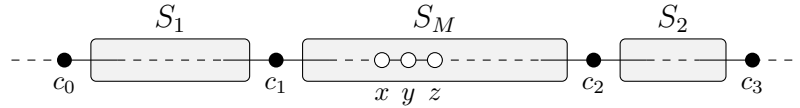

Figure 10: Notation of the proof (Lemma 5)

- Observe that $p \geq 1$, so C has cardinality at least 3 and observe by (O.1) that S_1 and S_2 are not empty. Hence, the elements c_1, c_2, c_3 may be supposed distincts and so on for elements c_0, c_1 and c_2 , but note that c_0 and c_3 may denote the same vertex.
- Observe by (O.1) that $|S_1| \geq R - 1$, $|S_2| \geq R - 1$, $M \geq R - 1$. Let us denote S the set $S_1 \cup \{c_1\} \cup S_M \cup \{c_2\} \cup S_2$.
- Observe that $|S| \geq 2r + 3$. Indeed, if c_0 and c_3 are different vertices, then $\{c_0\} \cup S \cup \{c_3\}$ is a set with 4 vertices of the code, so, by (O.2) $|S| + 2 > 2r + 2 + R \geq 2r + 4$. If c_0 and c_3 denote the same vertex, then $S \cup \{c_3\} = V(\mathcal{C}_n)$, $p = 1$ and $|S| = n - 1 = 2r + 1 + R \geq 2r + 3$.

So there are three consecutive vertices x, y, z in S such that $\{B_r(x) \cup B_r(y) \cup B_r(z)\} \cap C \subseteq \{c_1, c_2\}$ and $y \in S_M$.

To separate y and x , r_y must be $d(x, c_1)$ or $d(y, c_2)$. To separate y and z , r_y must be $d(y, c_1)$ or $d(z, c_2)$. Therefore, either $r_y = d(x, c_1) = d(z, c_2)$, or $r_y = d(y, c_2) = d(y, c_1)$. In all cases, M is odd and y is the middle element of S_M , so $d(y, c_1) = d(y, c_2)$. As $M \neq 1$ then $M \geq 3$ and $(x, z) \in S_M \times S_M$.

Let d_y denote $d(y, c_1)$ in the following. Let w be the vertex just before x . Then $B_r(w) \cap C \subseteq \{c_0, c_1, c_2\}$. To separate x from y , r_x must be $d(y, c_2) = d_y$ or $d(x, c_1) = d_y - 1$. To separate x from w , r_x must be $d(w, c_1) = d_y - 2$ or $d(x, c_2) = d_y + 1$ or $d(w, c_0)$. Necessarily, we have $r_x = d(w, c_0)$. This implies $d(w, c_0) = r$ because $d(w, c_0) = d(x, c_0) - 1 \geq r$ and $r_x \leq r$. Since $d_y \leq r$ and $r_x = d_y$ or $r_x = d_y - 1$. It follows $r_x = d_y = r$. Therefore $M = 2r - 1$, $|S_1| = 1$, and finally $R = 2$. With similar arguments for z , we obtain the situation depicted by Figure 11.

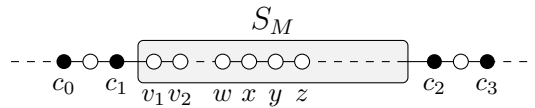

Figure 11: The sets S_1, S_2 and S_M after some deductions

Consider $(r, R) \neq (1, 2)$ or $(2, 2)$ and $R = 2$, then $r \geq 3$ and so $M \geq 5$. Let v_1 and v_2 be the two consecutive vertices in S_M following c_1 (see Figure 11). We have $d(v_2, c_2) = M - 1 > r$ and $d(v_1, c_2) > r$

so v_1 and v_2 can only be separated by elements of the code on the left of v_1 and v_2 . Let r_{v_1} be the radius that identifies v_1 . There must be an element of the code at distance exactly r_{v_1} of v_1 to separate v_1 and v_2 , and for similar reasons, there must be an element of the code at distance $r_{v_1} + 1$ of v_1 to separate v_1 from c_1 . This implies that two elements of the code are consecutive vertices in \mathcal{C}_n , which contradicts (O.1). \square

We are now able to compute $WC_r(\mathcal{C}_n)$ for all $n \geq 2r + 2$. Our results are summarized in the following theorem:

Theorem 2. *Let r be an integer and $n = (2r + 2)p + R$, with $0 \leq R \leq 2r + 1$ and $p \geq 1$, we have:*

- i) if $R = 0$, then $WC_r(\mathcal{C}_n) = 2p$,
- ii) if $R = 1$ or if $r \leq 2$ and $R = 2$, then $WC_r(\mathcal{C}_n) = 2p + 1$,
- iii) otherwise, $R \geq 2$ and $(r, R) \neq (1, 2)$ or $(2, 2)$, then $WC_r(\mathcal{C}_n) = 2p + 2$.

The following lemma completes the study for the small cases:

Lemma 6. *Let r and n be integers with $3 \leq n \leq 2r + 1$, then $WC_r(\mathcal{C}_n) = 2$.*

Proof

The code cannot be a single vertex, otherwise its two neighbors are not i -separated for any i , so $WC_r(\mathcal{C}_n) \geq 2$. Two adjacent vertices form a weak r -code for any r , so $WC_r(\mathcal{C}_n) = 2$. Note that if n is odd, the antipodal vertex to the code in the cycle is identified by the empty set. \square

3. Light r -codes of cycles

We now study light r -codes of the cycle \mathcal{C}_n . In this section, we will first assume that $n \geq 3r + 2$ and we will study the small values of n at the end of the section.

Lemma 7. *Let C be a light r -code of \mathcal{C}_n and c an element of C . There is another element of the code C at distance at most $r + 1$ of c .*

Proof

Let x and y be the neighbors of c . As C is a light r -code, there is an integer r_{xy} such that $0 \leq r_{xy} \leq r$ and $B_{r_{xy}}(x) \cap C \neq B_{r_{xy}}(y) \cap C$. There consequently exists a vertex $c' \in C$ such that, w.l.o.g., $c' \in B_{r_{xy}}(x)$ and $c' \notin B_{r_{xy}}(y)$. Moreover, $c \neq c'$ because $d(x, c) = d(c, y) = 1$. It follows that $d(c', c) \leq d(c', x) + d(x, c) \leq r_{xy} + 1 \leq r + 1$. \square

Lemma 8. *Let S be a set of $3r + 2$ consecutive vertices on \mathcal{C}_n . If C is a light r -code of \mathcal{C}_n , then S contains at least two elements of C .*

Proof

Let C be a light r -code of \mathcal{C}_n . Let us assume there is a set S of $3r + 2$ consecutive vertices of \mathcal{C}_n containing only one element c of C . w.l.o.g., we denote $S = \{v_0, v_1, \dots, v_{3r+1}\}$ and $c = v_i$ with $i < 2r$. By Lemma 7, there is an element c' at distance at most $r + 1$ of c . But $c' \notin S$ so necessarily, $c' \in \{v_{-1}, v_{-2}, \dots, v_{-(r+1)}\}$ and $i \leq r$. Then v_{2r+1} is not r -dominated by any element of C , a contradiction. \square

It follows from Lemma 8:

Corollary 2. *Let C be a light r -code of \mathcal{C}_n . Then $|C| \geq \lceil 2n/(3r + 2) \rceil$.*

In the following, let $n = (3r + 2)p + R$ with $0 \leq R \leq 3r + 1$ and $p \geq 1$ (by assumption, $n \geq 3r + 2$). Then Corollary 2 can be reformulated as: if C is a light r -code of \mathcal{C}_n , then we have

- if $R = 0$, then $|C| \geq 2p$,
- if $0 < 2R \leq 3r + 2$, then $|C| \geq 2p + 1$,
- otherwise, $2R > 3r + 2$, and $|C| \geq 2p + 2$.

We want to exhibit some optimum codes.

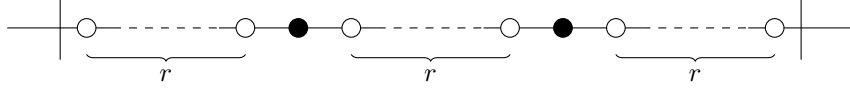

Figure 12: The pattern S for a light r -code in the cycles $C_{(3r+2)p}$ with $p \geq 1$

Lemma 9. *If $n = (3r+2)p$, then C_n has a light r -code with cardinality $2p$. Moreover this code is optimum.*

Proof

We construct the code by repeating the pattern S depicted by Figure 12. More precisely, let $C = \{v_i \mid i \equiv r \pmod{3r+2} \text{ or } i \equiv 2r+1 \pmod{3r+2}\}$. Set C is a r -dominating set of size $2p$ and we just need to check that every pair of vertices is separated by C for some radius in $\llbracket 0, r \rrbracket$. It is sufficient to prove it for all pairs (v_i, v_j) in the pattern S , i.e. with $(i, j) \in \llbracket 0, 3r+1 \rrbracket \times \llbracket 0, 3r+1 \rrbracket$. W.l.o.g. we study the case $i < j$, and we define r_{ij} as follows:

- if $j \leq r$, then $r_{ij} = r - j$;
- if $i \leq r < j$, then $r_{ij} = |(2r+1) - j|$;
- if $r < i \leq 2r$, then $r_{ij} = i - r$;
- if $i \geq 2r+1$, then $r_{ij} = i - (2r+1)$.

Then, $0 \leq r_{ij} \leq r$ and it is easy to check that (v_i, v_j) is r_{ij} -separated by C . So C is a light r -code of C_n with cardinality $2p$. This code is optimum by Corollary 2. \square

We generalize this construction:

Lemma 10. *If $1 \leq R \leq r+1$, then C_n has a light r -code of cardinality $2p+1$. If $R > r+1$, then C_n has a light r -code of cardinality $2p+2$.*

Proof

Consider the three following cases: (1) $R \in \llbracket 1, r+1 \rrbracket$, (2) $R \in \llbracket r+2, 2r+2 \rrbracket$, and (3) $R \in \llbracket 2r+3, 3r+1 \rrbracket$. For each case, we define the code C as:

- (1) $C = \{v_i \mid i < (3r+2)p, i \equiv r \pmod{3r+2} \text{ or } i \equiv 2r+1 \pmod{3r+2}\} \cup \{v_{(3r+2)p}\}$
- (2) $C = \{v_i \mid i < (3r+2)p, i \equiv r \pmod{3r+2} \text{ or } i \equiv 2r+1 \pmod{3r+2}\} \cup \{v_{(3r+2)p}, v_{(3r+2)p+r}\}$
- (3) $C = \{v_i \mid i < (3r+2)p, i \equiv r \pmod{3r+2} \text{ or } i \equiv 2r+1 \pmod{3r+2}\} \cup \{v_{(3r+2)p+r}, v_{(3r+2)p+2r}\}$

These sets are light r -codes of cardinality $2p+1$, $2p+2$ and $2p+2$, respectively. \square

Lemma 11. *If $R > r+1$, then C_n has no light r -code of cardinality $2p+1$.*

Proof

Assume that there is a code C of cardinality $2p+1$. First observe that in a set S of R consecutive vertices, there is at most one element of the code C . Otherwise, there will be only $2p-1$ elements of the code in the rest of the cycle which can be divided in p disjoint sets of size $3r+2$. One of this set will have only one element of the code, a contradiction by Lemma 8.

Now, take an element c of the code C , by Lemma 7 there is a vertex c' of the code at distance $d \leq r+1$ of c . Take the set S of all vertices between c and c' , c and c' included. S has cardinality at most $r+2 \leq R$ and has two vertices of C , a contradiction. \square

Our results are summarized in the following theorem:

Theorem 3. *Let r be an integer and $n = (3r+2)p + R$, with $0 \leq R < 3r+2$, and $p \geq 1$, we have:*

- i) if $R = 0$, then $LC_r(C_n) = 2p$;
- ii) if $R \leq r+1$, then $LC_r(C_n) = 2p+1$;
- iii) otherwise, $R > r+1$ and then $LC_r(C_n) = 2p+2$.

Theorem 3-i (resp. 3-ii, 3-iii) follows from Lemma 9 (resp. Corollary 2 and Lemma 10, and from Lemmas 10 and 11).

The next lemma completes the study for the small values of n :

Lemma 12. *Let r and n be integers with $3 \leq n \leq 3r + 1$, then $LC_r(\mathcal{C}_n) = 2$.*

Proof

A light r -code cannot be a single vertex otherwise the neighbors of the element of the code are not i -separated for any i . Two adjacent vertices form a light r -code for any $n \leq 2r + 2$. For $n > 2r + 2$, take two vertices at distance $r + 1$. \square

With light r -codes, we can assign up to $r + 1$ radii to a vertex to separate it from all the other vertices. Actually, for cycles, we just need three radii:

Proposition 1. *Let C be a light r -code of \mathcal{C}_n and x be a vertex of \mathcal{C}_n . Assume that $n > 2r + 1$. There is a subset R_x of $\llbracket 0, r \rrbracket$ of size at most 3 such that for all other vertices y of \mathcal{C}_n , there is $r_{xy} \in R_x$ such that $B_{r_{xy}}(x) \cap C \neq B_{r_{xy}}(y) \cap C$.*

Proof

Without loss of generality, we can assume that $x = v_0$.

Assume first that there exist two vertices of the code, say $a = v_i$ and $b = v_j$, such that $-r \leq i \leq 0 \leq j \leq r$ (if $x \in C$, then we have $a = b = x$). Thus $R_x = \{d(x, a), d(x, b)\}$ separates x from all the other vertices: vertices x and v_k are separated for radius $d(x, a)$ if $0 < k < n/2$ and for radius $d(x, b)$ if $-n/2 < k < 0$.

Otherwise, let $a = v_i$ be the element of the code closest to x . We can assume that $0 < i \leq r$. By Lemma 7 we know that there exists another element of the code $b = v_j$ such that $i < j$ and $j - i \leq r + 1$. Then x is separated from all vertices not in $B_i(a)$ by radius i , and from all vertices in $B_{i-1}(a)$ by radius $i - 1$. It remains one vertex, v_{2i} , that is separated from x for radius $d(v_{2i}, b) \leq r$. Finally the three radii i , $i - 1$, $d(v_{2i}, b)$ are enough to separate x from all vertices. \square

This proposition leads to the following question: what is the size of an optimum light r -code on \mathcal{C}_n that need to assign only 2 radii to each vertex? We solve this question in the next section.

4. Codes with 2 radii

A $(2, \llbracket 0, r \rrbracket)$ -code C of a graph G is a subset of vertices of G that r -dominates every vertex and such that for each vertex x , we can assign a set $R_x = \{r_x, r'_x\}$ of integers in $\llbracket 0, r \rrbracket$ such that every pair of distinct vertices (x, y) is r_x or r'_x -separated by C .

Lemma 13. *Let $k = \lfloor (r + 1)/3 \rfloor$ and $s = 3r - k + 2$. If s divides n , then the code defined by repeating the pattern S depicted by Figure 13 is a $(2, \llbracket 0, r \rrbracket)$ -code of \mathcal{C}_n .*

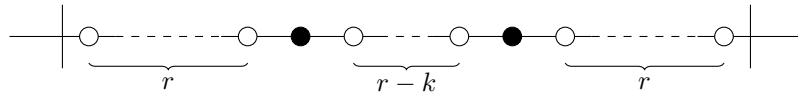

Figure 13: The pattern S for a $(2, \llbracket 0, r \rrbracket)$ -code of the cycle \mathcal{C}_n with n multiple of s (cf. Lemma 13)

Proof

We focalize on a pattern S . Denote by c_1 and c_2 the two vertices of the code of S and assume that $c_1 = v_0$. Then $c_2 = v_{r-k+1}$ and the vertices of S are the vertices between v_{-r} and v_{2r-k+1} . Partition the vertices of S in five subsets: $A_1 = \{v_{-r}, \dots, v_{-k-1}\}$, $A_2 = \{v_{-k}, \dots, v_{-1}\}$, $A_3 = \{v_0, \dots, v_{r-k+1}\}$, $A_4 = \{v_{r-k+2}, \dots, v_{r+1}\}$ and $A_5 = \{v_{r+2}, \dots, v_{2r-k+1}\}$. If $r = 1$, then A_2 and A_4 are empty; if $r = 0$, then A_3 is non empty and the other sets are empty. Let x be a vertex of S . Let R_x the set of radii associated to x :

- if $x \in A_1$, then set $R_x = \{d(x, c_1), d(x, c_1) - 1\}$;
- if $x \in A_2$, then set $R_x = \{d(x, c_1), d(x, c_2) - 1\}$;
- if $x \in A_3$, then set $R_x = \{d(x, c_1), d(x, c_2)\}$;
- if $x \in A_4$, then set $R_x = \{d(x, c_1) - 1, d(x, c_2)\}$;
- if $x \in A_5$, then set $R_x = \{d(x, c_2), d(x, c_2) - 1\}$.

One can check that $R_x \subset \llbracket 0, r \rrbracket$ in all cases. By symmetry, we just need to check that every vertex x of $A_1 \cup A_2 \cup A_3$ is separated from all the other vertices for a radius in R_x .

If $x \in A_1$, then x is separated from the vertices not in $B_{d(x, c_1)}(c_1)$ for radius $d(x, c_1)$ and from the vertices in $B_{d(x, c_1)-1}(c_1)$ for radius $d(x, c_1) - 1$. Remains the vertex y at distance $d(x, c_1)$ of c_1 . If $x = v_{-i}$, with $k+1 \leq i \leq r$, then $y = v_i$ and $d(y, c_2) = r - k + 1 - i \leq r - 2k \leq k + 1 \leq d(x, c_1)$ by definition of k . Notice that $d(x, c_2) > d(x, c_1)$, so x and y are separated for radius $d(x, c_1)$.

If $x \in A_2$, then x is separated from the vertices not in $B_{d(x, c_1)}(c_1)$ for radius $d(x, c_1)$ and from the vertices in $B_{d(x, c_2)-1}(c_1)$ for radius $d(x, c_2) - 1$. That covers all the vertices of the cycle.

One can check by the same kind of arguments that $x \in A_3$ is also separated from all the other vertices for $d(x, c_1)$ or $d(x, c_2)$. \square

Lemma 14. *Let C be a $(2, \llbracket 0, r \rrbracket)$ -code of \mathcal{C}_n . Let S be a set of $s = 3r - k + 2$ vertices with $k = \lfloor (r+1)/3 \rfloor$. Then S contains at least two vertices of C .*

Proof

For $r = 0$, the lemma is true as all the vertices must be 0-dominated. The lemma is also true for $r = 1$, as a $(2, \llbracket 0, 1 \rrbracket)$ -code is a light 1-code. Now, let $r \geq 2$. Notice that $3r - k + 2 > 2r$, thus S contains at least one vertex of C . By contradiction, assume that S contains only one vertex c of C , and w.l.o.g. assume $c = v_0$. Let v_{-a} be the first vertex of S and v_b be the last vertex of S , $a + b = 3r - k + 1$. We can assume that $a \leq b$. C is also a light r -code so by Lemma 7 $a \leq r$, then $b \geq 2r - k + 1$. C is r -dominating so $b \leq 2r$, and then $a \geq r - k + 1$. We have $B_r(v_k) \cap C = B_r(v_{k-1}) \cap C = B_r(v_{k+1}) \cap C = \{c\}$ because $d(v_k, v_{-a}) = a + k \geq r + 1$ and $d(v_k, v_b) = b - k \geq 2r - 2k + 1 \geq r + 1$. Then, v_k and v_{k-1} are only separated for radius $k - 1$, v_k and v_{k+1} are only separated for radius k . So necessarily v_k and v_{-k} must be separated for radius k or $k - 1$. That means there is a vertex of the code $c' \notin S$ different of c at distance at most k of v_{-k} . But $d(c', v_{-k}) = d(c', v_{-a}) + d(v_{-a}, v_{-k}) \geq 1 + a - k \geq r - 2k + 2 \geq k + 1$ (by definition of k), a contradiction. \square

As corollary, the code of Lemma 13 is optimum and we have the following lower bound, as for light and weak codes:

Corollary 3. *Let C be a $(2, \llbracket 0, r \rrbracket)$ -code of \mathcal{C}_n . Then $|C| \geq \lceil 2n/s \rceil$ with $s = 3r - \lfloor (r+1)/3 \rfloor + 2$.*

It remains the case where s does not divide n , with similar arguments used for light codes, one can show that:

Theorem 4. *Let n, r, s, p, R be integers, set $k = \lfloor (r+1)/3 \rfloor$, $s = 3r - k + 2$ and $n = sp + R$, with $0 \leq R < s$. Then the size of an optimum $(2, \llbracket 0, r \rrbracket)$ -code of \mathcal{C}_n is:*

- i) $2p$ if $R = 0$;
- ii) $2p + 1$ if $R \leq r + 1$;
- iii) $2p + 2$ otherwise.

5. Perspectives

Section 4 suggests the following definition that will generalize all the previous ones:

Definition 1. *Let p be an integer and \mathcal{R} be a set of non-negative integers. A (p, \mathcal{R}) -identifying code of a graph $G = (V, E)$ is a subset C of V such that:*

$$\begin{aligned}
 & \text{(domination)} \quad \forall x \in V, \exists r \in \mathcal{R}, B_r(x) \cap C \neq \emptyset \\
 & \text{(identification)} \quad \begin{cases} \forall x \in V, \exists R_x \subset \mathcal{R}, |R_x| \leq p, \forall y \in V, y \neq x, \exists r_{xy} \in R_x \text{ s.t.:} \\ B_{r_{xy}}(x) \cap C \neq B_{r_{xy}}(y) \cap C \end{cases}
 \end{aligned}$$

Integer p corresponds to the number of radii we can assign to a vertex to separate it from all the others whereas the set \mathcal{R} denotes the set of radii we can use. This definition unifies all the previous ones: a r -identifying code is a $(1, \{r\})$ -identifying code, a weak r -code is a $(1, \llbracket 0, r \rrbracket)$ -identifying code, a light r -code is a $(r + 1, \llbracket 0, r \rrbracket)$ -identifying code, a r -locating dominating code is a $(2, \{0, r\})$ -identifying code.

Proposition 1 is equivalent to say that every $(p, \llbracket 0, r \rrbracket)$ -code in a cycle, with $p \geq 3$ is a $(3, \llbracket 0, r \rrbracket)$ -identifying code. Section 4 and Section 2 consider $(2, \llbracket 0, r \rrbracket)$ -identifying codes and $(1, \llbracket 0, r \rrbracket)$ -identifying codes of the cycle, respectively. Hence we solved the problem of finding an optimum $(p, \llbracket 0, r \rrbracket)$ -identifying code (for any p) in a cycle. However, the general problem of finding an optimum (p, \mathcal{R}) -identifying codes in the cycle is still unknown.

References

- [1] N. Bertrand, I. Charon, O. Hudry, and A. Lobstein. Identifying and locating-dominating codes on chains and cycles. *Eur. J. Combin.*, 25(7):969–987, 2004.
- [2] N. Bertrand, I. Charon, O. Hudry, and A. Lobstein. 1-identifying codes on trees. *Aust. J. Combin.*, 31:21–35, February 2005.
- [3] I. Charon, S. Gravier, O. Hudry, A. Lobstein, M. Mollard, and J. Moncel. A linear algorithm for minimum 1-identifying codes in oriented trees. *Discrete Appl. Math.*, 154(8):1246–1253, 2006.
- [4] I. Charon, H. Honkala, O. Hudry, and A. Lobstein. The minimum density of an identifying code in the king lattice. *Discrete Math.*, 276(1-3):95–109, 2004.
- [5] I. Charon, O. Hudry, and A. Lobstein. Minimizing the size of an identifying or locating-dominating code in a graph is np-hard. *Theor. Comput. Sci.*, 290(3):2109–2120, 2003.
- [6] G. Chartrand, L. Eroh, M.A. Johnson, and O.R. Oellermann. Resolvability in graphs and the metric dimension of a graph. *Discrete Appl. Math.*, 105(1-3):99–113, 2000.
- [7] C.J. Colbourn, P.J. Slater, and L.K. Stewart. Locating dominating sets in series parallel networks. *Congr. Numer.*, 56:135–162, 1987.
- [8] S. Gravier, J. Moncel, and A. Semri. Identifying codes of cycles. *Eur. J. Combin.*, 27(5):767–776, 2006.
- [9] H. Honkala and A. Lobstein. On identifying codes in binary hamming spaces. *J. Comb. Theory A*, 99(2):232–243, 2002.
- [10] V. Junnila and T. Laihonen. Optimal identifying codes in cycles and paths. *submitted*, 2009.
- [11] M.G. Karpovsky, K. Chakrabarty, and L.B. Levitin. On a new class of codes for identifying vertices in graphs. *IEEE T Inform. Theory*, 44:599–611, 1998.
- [12] S. Khuller, B. Raghavachari, and A. Rosenfeld. Landmarks in graphs. *Discrete Appl. Math.*, 70(3):217–229, 1996.
- [13] A. Lobstein. <http://www.infres.enst.fr/~lobstein/bibLOCDOMetID.html>.
- [14] M. Xu, K. Thulasiraman, and X. Hu. Identifying codes of cycles with odd orders. *Eur. J. Combin.*, 29(7):1717–1720, 2008.