



HAL
open science

Column configurations of continuous heterogeneous extractive distillation

Ivonne Rodriguez-Donis, Katalin Papp, Endre Rev, Zoltan Lelkes, Vincent Gerbaud, Xavier Joulia

► To cite this version:

Ivonne Rodriguez-Donis, Katalin Papp, Endre Rev, Zoltan Lelkes, Vincent Gerbaud, et al.. Column configurations of continuous heterogeneous extractive distillation. *AICHE Journal*, 2007, vol. 53 n° 8., 1982-1993 available on : http://oatao.univ-toulouse.fr/10/2/gerbaud_10.pdf. <10.1002/aic.11225>. <hal-00467117>

HAL Id: hal-00467117

<https://hal.science/hal-00467117v1>

Submitted on 17 Oct 2023

HAL is a multi-disciplinary open access archive for the deposit and dissemination of scientific research documents, whether they are published or not. The documents may come from teaching and research institutions in France or abroad, or from public or private research centers.

L'archive ouverte pluridisciplinaire **HAL**, est destinée au dépôt et à la diffusion de documents scientifiques de niveau recherche, publiés ou non, émanant des établissements d'enseignement et de recherche français ou étrangers, des laboratoires publics ou privés.



HAL Authorization

Column Configurations of Continuous Heterogeneous Extractive Distillation

Ivonne RODRIGUEZ-DONIS¹, Katalin PAPP², Vincent GERBAUD³, Xavier JOULIA³, Endre REV², Zoltan LELKES²

¹Centro de Quimica Farmacéutica, Ave. 200 y 21 Atabey Apdo. 16042, Playa, C. Habana, Cuba

²Chemical Engineering Department, Budapest University of Technology and Economics, Műegyetem rkp. 3, H-1521 Budapest, Hungary

³Le Laboratoire de Génie Chimique, UMR CNRS 5503, ENSIACET-UPS-CNRS, BP 1301, 5 rue Paulin Talabot, F-31106 Toulouse, France

Accepted for publication in *AICHE Journal*, 53: 1982–1993, 2007

ABSTRACT

Increasing regulations and constraints have renewed interest for more efficient distillation process in separating azeotropic mixtures and close boiling components. We investigate the feasibility of heterogeneous extractive distillation process in a continuous column considering several feed point strategies for the entrainer recycle stream and for the main azeotropic feed. Depending on these choices, the heterogeneous distillation column is composed of one, two or three column sections. A differential mass balance model enables to compute continuous liquid composition profiles of the rectifying, extractive and stripping sections. Unlike homogeneous extractive distillation, reflux policy composed by a single or both decanted liquid phases is considered as well as the external feeding influence on the composition of the top column liquid stream. Limiting operating conditions of key parameters like the entrainer/feed flowrate ratio and reflux ratio required to obtain a target top and bottom product compositions are obtained. For illustration, separation of acetonitrile – water mixture using butyl acetate as a heavy heterogeneous entrainer is selected. In this case, withdrawal of a saddle binary heteroazeotrope is the main difference of this process compared with the well known heterogeneous azeotropic distillation process where the top vapor product is the lower boiling point of the ternary system.

Key words: continuous distillation, extractive distillation, heteroazeotropic distillation, feasibility, composition profile, top composition

Corresponding author : Vincent.Gerbaud@ensiacet.fr

Introduction.....	4
General heterogeneous extractive distillation column configuration	7
Feasibility methodology for continuous heterogeneous extractive distillation process.	7
The valid range for the liquid reflux composition x_R and for the top liquid composition x_0	9
Computation of column section composition profiles	11
Rectifying Column Section:.....	12
Extractive Column Section	12
Stripping Column Section.....	12
Variants of Continuous Distillation Process with Heterogeneous Entrainers. Feasibility Study.	13
Column configuration 1	13
Column configuration 2	13
Column configuration 3	14
Column configuration 4	15
Column configuration 5	15
Column configuration 6	16
Column configuration 7	16
Conclusions.....	17
Notation.....	18
References.....	19

INTRODUCTION

The separation of azeotropic mixtures or close boiling components is a challenging task in many chemical processes as it is impossible using a single conventional distillation column. Therefore, many non-conventional distillation techniques have been proposed in the vast literature published in the area and are described in several reference monographs.¹⁻⁴ The most common alternatives involve changing the operating pressure or adding a so called entrainer compound. The pressure option is economically feasible only for mixtures very sensitive to pressure. Consequently, the second alternative is the typical non conventional distillation process encountered in the industry and concerns so called azeotropic and extractive distillation processes. Synthesis and design of azeotropic and extractive distillation processes first depends on the miscibility of the entrainer with at least one of the original components. The entrainer is considered as heterogeneous if it causes liquid – liquid phase split over a range of compositions in the ternary phase diagram. Otherwise, the entrainer is homogeneous. Heterogeneous entrainers provide a simple technique to cross a basic distillation boundary and the total mass balance line can connect two streams placed in different distillation regions. Unlike to the heterogeneous distillation process, homogeneous entrainers allow only a feasible separation for the components limiting the same basic distillation region unless that ternary system contains distillation boundaries with a significant curvature.¹

Azeotropic and extractive distillation can be carried out in continuous or batch distillation column. In the case of batch operation, only a few differences exist between the column configuration needed to perform the azeotropic and extractive distillation process, especially when homogeneous entrainer is used. Entrainer is always loaded into the still at the beginning of the azeotropic distillation process while in extractive distillation, the entrainer must be fed continuously at some tray of the column or into the still during the whole operation.⁵⁻⁸ Because the composition of the liquid reflux and distillate are dissimilar when using heterogeneous entrainers, heteroazeotropic batch distillation is usually considered like a self-sustained continuous feeding process even if an amount of entrainer has to be added initially into the still. Therefore, similar column configuration can be used to perform azeotropic and extractive heterogeneous batch distillation mostly when fresh entrainer is fed at the top of the column.⁹⁻¹¹

More column configurations and technological alternatives can be used when azeotropic and extractive distillation process takes places in a continuous column depending on the strategy selected for the recycle streams connecting several columns even for homogeneous entrainers. Usually, a sequence of three connected continuous columns are used where the heterogeneous column and its decanter is the target of the design and synthesis analysis. An entrainer recovery

column and a pre-concentrator are commonly associated with the heteroazeotropic column. Doherty and coworkers¹²⁻¹³ made a critical analysis of heterogeneous azeotropic distillation process with different entrainer recycle strategy because feasibility of this process heavily depends on where the entrainer recycle stream returns to the heteroazeotropic column. More recently, Marquardt and coworkers presented a shortcut design method based on the rectification body method¹⁴ to design heterogeneous azeotropic distillation processes¹⁵ and extractive distillation columns¹⁶.

Considering a high boiling entrainer, seven main configurations can be set for the heteroazeotropic continuous column:

(1) The entrainer recycle is mixed to the azeotropic stream and fed at the same intermediate tray of the column,

(2) The entrainer stream is fed to an intermediate tray of the column above the azeotropic feed tray as is commonly used in homogeneous extractive distillation process,

(3) The entrainer is sent at the first top tray as a single external stream or mixed with the liquid reflux stream,

(4) Both the entrainer and the main azeotropic streams are introduced at the first top tray of the column, or mixed to the liquid reflux stream,

(5) The entrainer recycle stream is sent to the decanter whereas the main azeotropic feed is sent at intermediate tray of the column,

(6) Similar to (5) but a part of the distillate product is also recycled to the decanter in order to assure a liquid – liquid split in this vessel,

(7) The main azeotropic feed is introduced at the first top tray of the column or mixed to the liquid reflux, and the entrainer recycle stream is returned directly to the decanter.

According to the literature, only configurations 1, 3 and 5 have earlier been studied involving heterogeneous entrainer.² The feasibility study has not been performed for the four remaining configurations. In this article, a complete feasibility method is presented for the seven entrainer recycle stream alternatives for the heteroazeotropic continuous distillation column. The selected entrainer recycle strategy determines the number of sections of the column among three choices, namely, a rectifying section always located above the entrainer feed, a stripping section below the main azeotropic feed, and an extractive section located between both azeotropic and entrainer feeds. Liquid composition profiles of each section are computed by using the mass balance in differential form according to the model proposed by Lelkes *et al.*⁶ for a given operating conditions. In general, the heterogeneous distillation process is considered as feasible if the liquid composition profile inside a single column section or combined sections with two consecutive liquid composition

profiles intersecting at least once, goes from the bottom product composition to the column top tray liquid composition.

Feasibility study of each entrainer recycle alternative is illustrated for the separation of acetonitrile – water mixture at 1 atm by using butyl acetate as heterogeneous entrainer. Figure 1 shows the thermodynamic and topological features of the ternary system including the univolatility curve acetonitrile/water, which were computed by using Simulis Thermodynamics®, a thermodynamic property server available in various programming environments supporting COM middleware, like Microsoft Excel.¹⁷

Liquid – liquid – vapor, liquid – vapor and liquid – liquid equilibrium are calculated with NRTL model with binary interaction coefficients (Table 1) estimated from experimental data at atmospheric pressure.¹⁸ Vapor pressure is computed according to the DIPPR database correlation. The ternary diagram is divided in two basic distillation regions by an unstable separatrix connecting the unstable homogeneous azeotrope of minimum boiling point acetonitrile – water and the saddle heteroazeotrope water – butyl acetate. No ternary azeotrope is formed and the water and butyl acetate pure component vertexes are stable nodes while the acetonitrile pure component vertex is a saddle. One immiscibility gap spans through both distillation regions and the vapor line moves along the unstable separatrix connecting the binary azeotropes. The univolatility curve acetonitrile-water ($\alpha_{A-W} = 1$) begins at the homogeneous azeotrope and ends to the binary heterogeneous side water – butyl acetate. Therefore, feeding of fresh solvent and additional liquid reflux of the entrainer-rich phase or both liquid decanted phases provides the separation of the saddle binary heteroazeotrope at the top of the column allowing the water-rich phase as distillate.¹⁰ Being able to withdraw a saddle heteroazeotrope is the main difference of this separation comparing to the conventional heterogeneous distillation process where an unstable heteroazeotrope is always drawn at the top of the column. The zeotropic binary mixture acetonitrile - butyl acetate is then removed as a bottom product and separated in pure components in a subsequent continuous distillation column as shown in Figure 2.

The proposed feasibility methodology aims in determining the range of the design parameters which matches with a general feasibility criterion for any of the seven configurations of continuous heterogeneous extractive distillation process. If such design parameters are not found then the process is infeasible with the specified column configuration. The same methodology can also be used to find the limiting values of the design parameters ensuring feasibility but this issue is not presented in this manuscript.

GENERAL HETEROGENEOUS EXTRACTIVE DISTILLATION COLUMN CONFIGURATION

The general configuration for the heterogeneous distillation column is shown in Figure 3; taking into account the seven configurations combining the entrainer recycle stream and the main azeotropic feed. The heteroazeotropic distillation column is the aggregation of several parts among (i) a condenser and a decanter together, (ii) a rectifying section from the top of the column down to the entrainer recycle feed, (iii) an extractive section between the two feeds, and (iv) a stripping section from the main azeotropic feed to the bottom, including the boiler. Choosing the main azeotropic feed location (intermediate or column top) and the entrainer recycle strategy (mixed with the azeotropic feed or with the top liquid reflux or sent to an intermediate column point of the column or to the decanter) leads to any of the seven configurations described above considering that feeding the entrainer below the main azeotropic feed is also meaningless in our case (we restrict to the use of a heavy boiling entrainer). The most complex column configuration with 3 sections; rectifying, extractive and stripping ones; is obtained when the main azeotropic feed and the entrainer recycle stream are introduced at different intermediate points of the column (configuration 2).

Figure 4 displays a more detailed sketch of the composite (top column + condenser + decanter) part considering the influence of the entrainer recycle F_E and the azeotropic feed F_F on the liquid composition and flowrates involved in this column section. Subscripts T , D and I refer respectively to a feed (F_{FT} and or F_{ET}) supplied at the column top feed along with the liquid reflux (configurations 3 and 4), mixed (F_{ED}) with the condensed vapor and sent to the decanter (configurations 5, 6 and 7), or fed (F_{FI} and or F_{EI}) at an intermediate point of the column as a combined or separate feeds (configurations 1 and 2).

FEASIBILITY METHODOLOGY FOR CONTINUOUS HETEROGENEOUS EXTRACTIVE DISTILLATION PROCESS.

The feasibility methodology is based on the analysis of the liquid composition profile computed for each column section for given operating parameters values. The process is feasible if the specified product compositions at the top (x_D) and the bottom (x_W) of the column can be connected by a single or by a composite composition profile. A single composition profile belongs to one column section and a composite composition profile is composed by two or three column section composition profiles connected at some punctual composition.

The x liquid composition profiles in each column section can be computed according to the

general differential model of Lelkes *et al.*⁶:

$$\frac{dx}{dh} = \pm \frac{V}{L} (\mathbf{y}(\mathbf{x}) - \mathbf{y}^*(\mathbf{x})) \quad (1)$$

Where V and L are the vapor and liquid flowrates within the column. The vapor composition \mathbf{y}^* in equilibrium with \mathbf{x} is computed by the liquid – vapor equilibrium relation $\mathbf{y} = K.\mathbf{x}$ and the actual vapor composition \mathbf{y} is computed from the mass balance (the so-called operating line) valid in each column section, depending on the chosen column configuration.

This is a continuous model derived via a truncated series expansion of a staged model. As a differential model, it is well suited for the study of singularities (stable or unstable node, saddle) and eventual boundaries of the liquid composition profile maps that may affect feasibility under various operating conditions. Feasibility and limiting parameter values like minimum reflux which supposes sometimes to assess intersection of composition profiles are also easier to assess with continuous composition profiles from the differential model than with discrete composition profiles from distillation line calculations as investigated in earlier works.¹⁹

The differential model is, however, neither related to theoretical or real stages, nor it is based on mass transfer equations. It cannot be used to evaluate a finite number of stages within some column section like with the distillation line calculations under higher than minimum reflux conditions.¹⁹ Finally, it contains the same driving force $\mathbf{y}-\mathbf{y}^*$ as occurs in the well-known NTU-HTU mass transfer model.

The differential equation (1) is an initial value problem that should be solved by starting the computation from a known liquid composition. The double sign \pm shown in equation (1) is to be actualized according to the direction (top down or bottom up) considering that column height h is equal to zero at the top. Therefore, equation (1) must be used in computing the liquid composition profile of a rectifying, extractive and stripping column section with an adequate definition of the initial point for \mathbf{x} , and the direction of the solution and the mass balance equation for \mathbf{y} . The driving force applied in equation (1) is to be understood at a given column height h . This is valid even at the very top of the column. The composition of the vapor emerging from the column top \mathbf{y}_1 , and the imagined vapor composition that would be in equilibrium \mathbf{y}^* with the countercurrent liquid \mathbf{x}_0 are in the same relation. Therefore, the composition of this countercurrent liquid \mathbf{x}_0 is a good candidate to be an initial point for the higher (rectifying or extracting) column section and the equation is solved top down. Otherwise, if the bottom composition \mathbf{x}_W is known then it can be directly applied as the initial value, and equation (1) is solved bottom up in the lowest (stripping) column section keeping a negative sign.

Thus, computation of the top (rectifying or extractive) column section composition profile should

be started from the composition of the liquid flowing on the top of the column if there are at least two column sections. This is called ‘the top liquid composition’, and denoted by \mathbf{x}_θ (see Figure 3 and 4). The top liquid composition \mathbf{x}_θ is identical to the composition of the reflux stream \mathbf{x}_R if there is not external feed mixed with the liquid reflux ($F_{ET}=F_{FT}=0$). This \mathbf{x}_R , in turn, is identical to the distillate composition \mathbf{x}_D if there is no liquid phase distribution into the decanter (homogeneous case). This difference with homogeneous extractive distillation process is taken into account in the feasibility methodology that we will describe below. If there is a liquid phase distribution then, the composition of the reflux stream \mathbf{x}_R is determined by the compositions \mathbf{x}_D and \mathbf{x}^I of the distributed liquid phases, and the reflux ratio R , together. Besides, if there is some external liquid feed sent to the top of the column (either positive F_{FT} or F_{ET} in Figure 4; configurations 3 and 4) then it should be accounted as a feed mixed to the reflux stream. The top liquid composition \mathbf{x}_θ is then determined by the mass balance of mixing the external feed stream to the reflux stream (envelope [c] in Figure 4).

Finally, if there are three sections in the column then the rectifying and stripping composition profiles begin at \mathbf{x}_R and \mathbf{x}_W , respectively, whereas for exploring the range of potentially valid extractive composition profiles (the intermediate column section) a series of composition profiles should be computed started from several points in the composition triangle.

THE VALID RANGE FOR THE LIQUID REFLUX COMPOSITION \mathbf{x}_R AND FOR THE TOP LIQUID COMPOSITION \mathbf{x}_θ

The specified distillate composition \mathbf{x}_D lies on the component-rich side of the binodal curve at the specified temperature T_{dec} . Thus, \mathbf{x}_D belongs to a distinct liquid-liquid equilibrium tie line at T_{dec} (see Figure 1) which other end on the entrainer-rich side is noted \mathbf{x}^I . Since the distillate is produced as (part of) one phase formed in the decanter, the gross composition \mathbf{x}_G in the decanter should lie on this tie line (see Figure 4). Considering a possible P flowrate of the distillate product recycled along an external entrainer feed F_{ED} to the decanter (or to the condenser), a mass balance around envelope [a] in Figure 4 holds:

$$V \cdot \mathbf{y}^I + F_{ED} \cdot \mathbf{x}_E + P \cdot \mathbf{x}_D = (V + F_{ED} + P) \cdot \mathbf{x}_G = L_G \cdot \mathbf{x}_G \quad (2)$$

When $F_{ED} = 0$ and $P = 0$, $\mathbf{y}^I = \mathbf{x}_G$ holds.

The reflux ratio R is defined by the usual ratio of L_R to D flowrates. The actual value of R cannot be smaller than the actual phase ratio, because phase I is totally refluxed and not mixed to the distillate. L^I / L^II is determined by \mathbf{x}_G :

$$\frac{L^I}{L^{II}} = \frac{\mathbf{x}_{iG} - \mathbf{x}_{iD}}{\mathbf{x}_i^I - \mathbf{x}_{iG}} \quad \text{where} \quad (\mathbf{x}_i^I - \mathbf{x}_{iG}) \neq 0 \quad (3)$$

The liquid reflux stream composition \mathbf{x}_R is constrained between \mathbf{x}_D and \mathbf{x}^I . The liquid – liquid splitting ratio into the decanter ω is defined as $L^I / (L^I + L^{II})$. For design purposes, L^{II} should not be smaller than D . So, there is a maximum value of ω_{max} that matches with the condition $L^{II} = D$:

$$\omega_{max} = 1 - \left(\frac{D}{L_G} \right) \quad (4)$$

Part of L^{II} can also be refluxed if $\omega < \omega_{max}$ and, therefore, (L^I / L^{II}) is smaller than R . Thus, for a given x_G , and so a L^I / L^{II} value, there is a lower bound to R :

$$R \geq \frac{L^I}{L^{II}} \quad (5)$$

The ratio L^I to L^{II} may vary between 0 and infinity, and \mathbf{x}_R may vary between \mathbf{x}_D and \mathbf{x}^I .

A feasibility study is performed while changing design parameters R and F_E , we determine the constraint on \mathbf{x}_G , \mathbf{x}_R , and \mathbf{x}_0 , for a given R . Denote the flowrate of refluxed distillate product phase by L^{III} ; then from the definition of R , and from material balance, we get

$$L_R = L^I + L^{III} = R \cdot D = R \cdot (L^{II} - L^{III}) \quad (6)$$

By rearranging equation (5) and (6), L^{III} can be expressed:

$$L^{III} = \begin{cases} 0 & ; \quad \text{if} \quad R = \frac{L^I}{L^{II}} \\ \frac{R \cdot L^{II} - L^I}{1 + R} & ; \quad \text{if} \quad R > \frac{L^I}{L^{II}} \end{cases} \quad (7)$$

The reflux composition \mathbf{x}_R by mass balance around the envelope [b] (Figure 4) is:

$$\mathbf{x}_R = \frac{L^I \cdot \mathbf{x}^I + L^{III} \cdot \mathbf{x}_D}{L^I + L^{III}} \quad (8)$$

The two extremes of \mathbf{x}_R can be determined by taking the limits of the phase ratio. If phase I is negligible compared to phase II then \mathbf{x}_R approaches \mathbf{x}_D by limit.

$$\mathbf{x}_R \Big|_{L^I / L^{II} \rightarrow 0} = \mathbf{x}_D \quad (9)$$

If the phase ratio L^I to L^{II} approaches R (from below) then L^{III} approaches 0, and \mathbf{x}_R approaches \mathbf{x}^I :

$$\mathbf{x}_R \Big|_{L^I / L^{II} \rightarrow R} = \mathbf{x}^I \quad (10)$$

Thus, the valid set of \mathbf{x}_R is the whole tie line $\mathbf{x}_D - \mathbf{x}^I$ shown in Figure 1 and should be explored for checking feasibility at a given R , even if the range of x_G is constrained by the condition $L^{II} \geq D$.

The top liquid composition \mathbf{x}_0 depends on the column configuration, as explained below. Because

a possible external feed (F_{ET} or F_{FT}) is mixed with the liquid reflux at the top of the column (see Figure 4), \mathbf{x}_0 and \mathbf{x}_R are unlike. Based on the general mass balance according to envelope [c] in Figure 4:

$$\mathbf{x}_0 = \frac{R \cdot D \cdot \mathbf{x}_R + F_{FT} \cdot \mathbf{x}_F + F_{ET} \cdot \mathbf{x}_E}{R \cdot D + F_{FT} + F_{ET}} \quad (11)$$

The valid range of \mathbf{x}_0 is also determined by varying \mathbf{x}_R along the full length of the tie line $\mathbf{x}_D - \mathbf{x}^I$. The two end-points of this straight line are:

$$\mathbf{x}_0^D = \frac{R \cdot D \cdot \mathbf{x}_D + F_{FT} \cdot \mathbf{x}_F + F_{ET} \cdot \mathbf{x}_E}{R \cdot D + F_{FT} + F_{ET}} \quad (12)$$

$$\mathbf{x}_0^I = \frac{R \cdot D \cdot \mathbf{x}^I + F_{FT} \cdot \mathbf{x}_F + F_{ET} \cdot \mathbf{x}_E}{R \cdot D + F_{FT} + F_{ET}} \quad (13)$$

If $F_{FT} = 0$ and $F_{ET} = 0$, then $\mathbf{x}_0 = \mathbf{x}_R$ and the valid range of \mathbf{x}_0 is the tie line $\mathbf{x}_D - \mathbf{x}^I$.

COMPUTATION OF COLUMN SECTION COMPOSITION PROFILES

Having in mind the general column configuration displayed in Figures 3 and 4, equation (1) can be used to compute the liquid composition profile in each column section. They depend on the azeotropic feed flowrate (F_F) and composition (\mathbf{x}_F), the entrainer flow rate (F_E) and composition (\mathbf{x}_E), the recycled distillate flow rate to the decanter (P), the specified recovery ratio of the primary key component A (η_A), the decanter temperature (T_{dec}), the entrainer-rich phase composition (\mathbf{x}^I), the distillate composition (\mathbf{x}_D , component-rich phase composition), the operating pressure (Pr), the reflux ratio (R).

Given these operating variables, the other overall operating parameters can be computed such as vapor (V), distillate (D) and bottom product (W) flowrates, the bottom product composition (\mathbf{x}_W) and the liquid flowrate in each column section: L_R , L_E and L_W for the rectifying, extractive and stripping section, respectively. These unknowns are determined by mass balance, taking into account the combinations (condenser + decanter) in Figure 4 and around the whole column in Figure 3:

$$D = \frac{\eta_A \cdot F_F \cdot x_{F,A}}{x_{D,A}} \quad (\text{composition mass balance for the primary key component A}) \quad (14)$$

$$W = F_F + F_E - D = F_T - D \quad (\text{total mass balance}) \quad (15)$$

$$x_w = \frac{F_F \cdot x_F + F_E \cdot x_E - D \cdot x_D}{W} = \frac{F_T \cdot x_T - D \cdot x_D}{W} \quad (\text{component mass balance}) \quad (16)$$

Considering all the three column sections, the particular expressions for equation (1) for the

column sections are the following:

Rectifying Column Section:

The operating vapor $y(\mathbf{x})$ can be computed from the mass balance around the column top section involving the internal flows V and $L=L_R$ of the rectifying section and the external stream D , resulting in the following equations:

$$y(\mathbf{x}) = \frac{L_R \cdot \mathbf{x} + D \cdot \mathbf{x}_D}{V} \quad (17a)$$

$$L_R = L_0 = V - D = R \cdot D \quad (\text{Balance envelope [c] in Figure 4 with } F_{FT} = F_{ET} = 0) \quad (17b)$$

$$V = L_0 + D = (R + 1) \cdot D \quad (\text{Balance envelope [d]s in Figure 4 with } F_{FT} = F_{ET} = F_{ED} = 0) \quad (17c)$$

$$\mathbf{x}_{start} = \mathbf{x}_R \quad (17d)$$

Extractive Column Section

The operating vapor $y(\mathbf{x})$ can be computed from the mass balance around the column intermediate section involving the internal flows V and $L=L_E$ of the extractive section and the external streams D , F_{EI} , F_{FT} , F_{ET} and F_{ED} , resulting in the following equations:

$$y(\mathbf{x}) = \frac{L_E \cdot \mathbf{x} + D \cdot \mathbf{x}_D - F_{FT} \cdot \mathbf{x}_F - (F_{EI} + F_{ET} + F_{ED}) \cdot \mathbf{x}_E}{V} \quad (18a)$$

$$L_E = V + F_{EI} + F_{FT} + F_{ET} + F_{ED} - D \quad (18b)$$

$$L_0 = L_R + F_{FT} + F_{ET} = R \cdot D + F_{FT} + F_{ET} \quad (\text{balance envelope [c] in Figure 4}) \quad (18c)$$

$$V = L_0 + D - F_{FT} - F_{ET} - F_{ED} \quad (\text{balance envelope [d] in Figure 4}) \quad (18d)$$

Depending on the column configuration, \mathbf{x}_{start} is either \mathbf{x}_R or \mathbf{x}_0 , or a selected final point of the stripping composition profile \mathbf{x}_W , or some other composition in the triangle.

Stripping Column Section

The operating vapor $y(\mathbf{x})$ can be computed from the mass balance around the lowest column section involving the internal flows V and $L=L_S$ of the stripping section and the bottom product W , resulting in the following equations:

$$y(\mathbf{x}) = \frac{L_S \cdot \mathbf{x} - W \cdot \mathbf{x}_W}{V} \quad (19a)$$

$$\text{Where } L_S = V + W \quad (19b)$$

V is the previously calculated value for the rectifying (equation 14c) or extractive section

(equation 15c) and,

$$\mathbf{x}_{start} = \mathbf{x}_W \quad (19c)$$

VARIANTS OF CONTINUOUS DISTILLATION PROCESS WITH HETEROGENEOUS ENTRAINERS. FEASIBILITY STUDY.

The column configuration for heterogeneous distillation process depends on the selected strategy for the entrainer recycle stream and the main azeotropic feed. Therefore, the seven configurations mentioned above are considered. For all cases, the decanter temperature equals 25°C and the total pressure equals 1 atm. Table 2 reports the operation conditions.

Column configuration 1

One may consider this case as mixing the entrainer recycle stream with the main azeotropic feed, and leading this mixed feed to an intermediate point of the column (F_{FI} and $F_{EI} > 0$ and $F_{FT} = F_{ET} = F_{ED} = P = 0$ in Figure 3). Pham *et al.*¹⁹ studied the sensitivity of the design parameters by using this column configuration for the separation of the binary mixture isopropanol – water with the addition of benzene as an intermediate entrainer.

There is a stripping section and a rectifying section below and above the composed feed, respectively. The process is feasible if the stripping composition profile intercepts at least one rectifying composition profile. The possible rectifying composition profiles are computed top down starting from valid values of $\mathbf{x}_0 = \mathbf{x}_R$ for several decanter split ratios $\omega < \omega_{max}$ which sets the \mathbf{x}_0 location on the liquid – liquid tie-line $\{\mathbf{x}_D; \mathbf{x}^I\}$. The stripping composition profile is computed bottom up, starting from the unique \mathbf{x}_W .

For $R=10$, Figure 5 displays a map of rectifying composition profiles for several values of \mathbf{x}_R placed on the appropriated liquid – liquid tie-line $\{\mathbf{x}_D; \mathbf{x}^I\}$ at T_{dec} . The profile starting at $\mathbf{x}_R = \mathbf{x}^I$ corresponds to $\omega = \omega_{max}$ and the reflux of entrainer-rich phase is only considered. Otherwise, the liquid reflux is composed by both decanted liquid phases. As seen in Figure 5, the feasibility criterion is not satisfied for the chosen operating conditions.

Column configuration 2

Both the main azeotropic feed F_{FI} and the entrainer recycle F_{EI} feed are fed to different intermediate points of the column, F_{EI} above F_{FI} . In this configuration, $F_{FT} = F_{ET} = F_{ED} = P = 0$. Compared to configuration 1, there is an additional extractive section between the two feeds. A

similar column configuration without decanter is a typical process applied for the separation of non-ideal mixtures with homogeneous extractive continuous distillation.² No initial point is known for computing the possible extractive composition profiles. Hence, extractive composition profiles must be computed from several compositions values as initial points selected inside the ternary diagram (e.g. [0.4; 0.3; 0.3], [0.4; 0.2; 0.4], [0.4; 0.1; 0.5]).

The process is feasible if the stripping and any rectifying liquid composition profiles intercept or are connected by at least one extractive composition profile.

Figure 6 shows that the feasibility criterion is now satisfied for the same operating conditions as configuration 1. Thus, for the same operating conditions reported in Table 2, the heterogeneous extractive distillation process is feasible with two separated external feeds, three column sections, but not with one mixed feed and two column sections.

Column configuration 3

The main azeotropic feed F_{FI} is fed to an intermediate point of the column whereas the entrainer F_{ET} is sent at the first top tray of the column top or is mixed with the liquid reflux stream. Compared to configuration 2, no rectifying section is present ($F_{EI}=F_{FT}=F_{ED}=P=0$). Doherty and coworkers¹²⁻¹³ established a design method and a new optimization procedure for this column configuration by using the residue curve analysis applied to separate ethanol – water with benzene and also using discrete tray by tray composition profiles.

The process is feasible if the stripping composition profile computed from the single x_W intercepts any extractive composition profile that reaches the valid x_θ line computed from equations 12 and 13. This line can also be determined graphically by projecting the selected tie line (the range of valid x_R) toward the entrainer feed composition x_E . Such a projection is shown in Figure 7.

Four extractive composition profiles are displayed in Figure 7. They all satisfy the feasibility criterion. As it is usual²⁰⁻²¹, all extractive composition profiles finish at the same singular point stable node S_n on the binary heterogeneous edge water – butyl acetate. It should also be noted that interception of the extractive composition profiles and the liquid – liquid tie-line $\{x_D=x''; x'\}$ at T_{dec} takes place in a narrow composition range. Hence, the liquid – liquid splitting ratio ω range in the decanter is limited, too. In conclusion, the process is feasible without a rectifying section, considering the operating conditions reported in Table 1. Only two sections, extractive and stripping, are necessary to perform the heterogeneous distillation process with this column configuration.

Column configuration 4

Both feeds are mixed to the liquid reflux stream or they are introduced at the first top tray of the column or along with the liquid reflux stream (Figure 8). Such a column has therefore a single stripping section computed from \mathbf{x}_W . The line of valid \mathbf{x}_0 $\{\mathbf{x}_0^I, \mathbf{x}_0^D\}$ can be computed from equations 12 and 13 or determined graphically by first projecting the liquid – liquid tie-line toward the entrainer composition \mathbf{x}_E similarly to the previous case (Figure 7), and then by projecting the resultant straight line section toward the feed composition \mathbf{x}_F , as it is shown in Figure 8, for the operating parameters displayed in Table 2.

The process is feasible with a single stripping column section if the stripping composition profile starting from \mathbf{x}_W intersects the straight line section of \mathbf{x}_0 .

As seen on figure 9 for three different operating conditions, the valid line of \mathbf{x}_0 expands when R increases and moves towards E when F_E increases. Feasibility is not ensured by increasing R (variant B) but only for a large entrainer flowrate F_{ET} (variant C). In this case, the \mathbf{x}_0 line is closer to the heterogeneous binary side water – butyl acetate and the composition of the entrainer in the bottom product (\mathbf{x}'_W) is higher than the other variants ($F_{ET} = 5$).

Column configuration 5

The main feed (F_{FI}) is fed to an intermediate point of the column; the entrainer (F_{ED}) is fed to the decanter or to the condenser. This is a conventional azeotropic distillation also applied to separate non-ideal mixtures with heterogeneous entrainers ($F_{FT} = F_{EI} = F_{ET} = P = 0$). There is a stripping section below the main feed and the upper section is conventionally a rectifying section. In practice and in this paper, this rectifying section is considered as an extractive one because the heavy entrainer is fed to the decanter. Studies on design and optimization of this column configuration showed that such an entrainer recycle strategy usually demands higher reflux ratio.¹² Rigorous simulation of this case was also published²², considering the separation of isopropanol – water with benzene.

The stripping composition profile can be computed bottom up started from \mathbf{x}_W . On the other hand, the possible extractive composition profiles can be computed top down, started from valid values of \mathbf{x}_R determined from equation (8) In this case, we consider that \mathbf{x}_R is independent of the existence of the top external feeds to the decanter. If there is some external feed applied to the condenser or the decanter then it has a direct influence on the ratio of the phases in the decanter (ω), but it does not influence \mathbf{x}_D and \mathbf{x}^I because they are only determined by the thermodynamic liquid – liquid equilibrium in the decanter at T_{dec} . So, \mathbf{x}_R and \mathbf{x}_0 are equal and they are determined by the reflux

ratio and the liquid – liquid split ratio (ω) into the decanter.

The process is feasible if the stripping composition profile intercepts at least one extractive composition profile that reaches the selected liquid – liquid tie line.

The resulting mixture between the top vapor y_T and the fixed $F_{ED}=2 \text{ mol.s}^{-1}$ provides a total decanter composition x_G on the specified liquid – liquid tie-line. Figure 10 shows that the process is feasible with the operating conditions.

Column configuration 6

In a variant of configuration 5, some portion P of distillate with composition x_D can be also mixed back to the decanter (Figure 11). Therefore, in this column configuration, the main feed F_{FI} , the entrainer recycle stream F_{ED} and the distillate recycle P are all positive, whereas $F_{FT} = F_{EI} = F_{ET} = 0$.

Despite losing some distillate flowrate, such strategy has some practical interest providing the liquid – liquid splitting into the decanter when it can not be reached by simple addition of entrainer recycle stream by using the others variants (that is x_G lying in the homogeneous area and not studied here because x_G is always placed on the selected liquid – liquid tie - line). Similar to the configuration 5, the heterogeneous distillation column has two sections: an extractive and a stripping section above and below the main azeotropic feed F_{FI} , respectively.

The process is feasible if the stripping composition profile intercepts at least one extractive composition profile that reaches the selected liquid – liquid tie-line.

Figure 11 shows that the process is again feasible. Compared to the former configuration (Figure 10), the decanter mass balance line links the composite composition of the mixture ($P+F_{ED}$) (instead of x_E) with the vapor top y_T giving x_G on the specified liquid – liquid tie-line. Note, the composition of the top vapor stream y_T has a lower water composition that is compensated by the distillate recycle. Again, all extractive composition profiles finish at the same heterogeneous extractive node.

Column configuration 7

This column configuration is a combination of configurations 4 and 5 in order to provide a feasible heterogeneous distillation process with a smaller (entrainer/azeotropic) flowrate ratio when the main azeotropic stream is introduced at the column top (F_{FT}) along with the reflux liquid. In this case, the entrainer recycle stream F_{ED} is sent to the decanter (Figure 12). Therefore, $F_{FI} = F_{EI} = F_{ET} = P = 0$. Similar to configuration 4, the heterogeneous distillation column has a single section. It can be considered as a stripping or as an extractive column section. The addition of the main

azeotropic feed at the column top forces \mathbf{x}_0 not to be equal to \mathbf{x}_R even if $F_{ET} = 0$. The valid \mathbf{x}_0 line is computed from equations 12 and 13 or can also be determined graphically by projecting the liquid – liquid tie line (the range of valid \mathbf{x}_R) toward the feed composition, that is the azeotropic composition of the original binary mixture acetonitrile – water (Figure 12).

The process is feasible if the stripping composition profile intercepts the valid line of \mathbf{x}_0 .

As seen in Figure 12, feasibility requires increasing both R and F_{ED} compared to the conditions of configuration 5. But, with these new parameter set (variant B); the (entrainer/feed) flowrate ratio is significantly lower than for configuration 4.

CONCLUSIONS

Feasibility of the separation of binary azeotropic mixtures A-B by continuous extractive distillation process using a so-called heterogeneous entrainer is studied by considering heavy boiling entrainer only. The main difference of this process compared with the well established heterogeneous azeotropic distillation process is the removal as the overhead vapor of a saddle heteroazeotrope instead of an unstable heteroazeotrope, thanks to the continuous feeding of the entrainer. Seven alternative feeding strategies, four of which are new, were considered for the entrainer recycle stream and the original azeotropic feed. Each alternative strategy defines a particular configuration of the heterogeneous distillation column, notably in terms of different column sections.

A short-cut method based on a general differential model was extended for the heterogeneous extractive distillation in order to compute the rectifying, extractive, and stripping composition profiles of each column configuration allowing the feasibility analysis for fixed operating parameters. The overall process feasibility criterion is given by a connection point between all liquid composition profiles belonging to the specified column configuration. In addition, extremes of liquid composition profiles must be connected to expected purity composition for distillate and bottom product. In the heterogeneous case, it requires a careful evaluation of the top liquid composition \mathbf{x}_0 and the reflux composition \mathbf{x}_R depending on the recycling strategy.

A feasibility analysis of the seven configurations has been conducted for the separation of acetonitrile – water mixture with butyl acetate as a heavy heterogeneous entrainer. This ternary system exhibits a saddle binary heteroazeotrope water – butyl acetate that can be only drawn at the column top if the heterogeneous entrainer is recycled to the column at specific location. If the entrainer is sent to an intermediate tray of the column, the separation is performed with three column sections (rectifying, extractive, and stripping) in the same manner as the homogeneous

extractive distillation process does (configuration 2). Furthermore, the rectifying section is not necessary to the feasibility when the entrainer is recycled at the column top (in the decanter or along with the liquid reflux) and the process is feasible with only two column sections (configurations 3, 5, 6). If both external streams are fed simultaneously at the same point of the column (intermediate or top), the process is not feasible (configuration 1) or it requires extreme operating conditions (configuration 4). Feasibility of the process with only a stripping section can be achieved by feeding the entrainer recycle stream into the decanter (configuration 7), but a greater amount of entrainer and greater reflux ratio are required than in the configuration cases where an extractive section also exists.

The methodology used in this work can be applied to determine the limiting values of the parameters enabling the separation to be feasible as it was shown.

NOTATION

Roman letters

D	distillate flowrate
F	feed flowrate
h	column height
L	internal liquid flowrate
P	partial recycle flowrate
Pr	operating pressure
R	reflux ratio
T	temperature
V	internal vapor flowrate
W	bottom flowrate
x	liquid molar composition
y	vapor molar composition
y*	vapor molar composition in vapor liquid equilibrium with x

Greek letters

η	recovery ratio
ω	split ratio in the decanter

Superscript

- I refers to entrainer rich phase in the decanter
- II refers to entrainer lean phase in the decanter
- R refers to reflux stream

Subscript

- 0 refers to the top liquid stream
- 1 refers to the top vapor stream
- A refers to main component in distillate
- B refers to the column bottom
- D refers to the decanter
- dec refers to the decanter
- E refers to the entrainer feed
- F refers to main feed
- G refers to the stream entering the decanter
- I refers to an intermediate position in the column
- i refers to component i
- R refers to the reflux stream
- T refers to the column top
- W refers to the residu stream

REFERENCES

1. Widagdo S, Seider WD. Azeotropic Distillation. *AIChE J.* 1996;42:96-130.
2. Perry RH, Green DW, Maloney JO. Perry's Chemical Engineer's Handbook. (Seventh edition). New York: McGraw Hill, 1997.
3. Stichlmair JG, Fair JR. Distillation: Principles and Practice. New York: Wiley – VCH, 1998.
4. Doherty MF, Malone MF. Conceptual design of Distillation Systems. New York: McGraw-Hill Chemical Engineering Series, 2001.
5. Lang P, Lelkes Z, Otterbein M, Benadda B, Modla G. Feasibility studies for batch extractive distillation with a light entrainer. *Comp Chem Eng.*, 1999;23, Suppl:S93-S96.

6. Lelkes Z, Lang P, Benadda B, Moszkowicz P. Feasibility of extractive distillation in a batch rectifier. *AIChE J*, 1998;44:810-822.
7. Rev E, Lelkes Z, Varga V, Steger C, Fonyo Z. Separation of a minimum-boiling azeotrope in a batch extractive rectifier with an intermediate-boiling entrainer. *Ind Eng Chem Res*. 2003;42:162-174.
8. Lelkes Z, Rev E, Steger C, Fonyo Z. Batch extractive distillation of maximal azeotrope with middle boiling entrainer. *AIChE J*, 2002;44:2524-2536.
9. Rodríguez-Donis I, Gerbaud V, Joulia X. Feasibility of Heterogeneous Batch Distillation, *AIChE J*. 2002;48:1168-1178.
10. Rodríguez-Donis I, Acosta-Esquivarosa J, Gerbaud V, Joulia X. Heterogeneous batch extractive distillation of minimum boiling azeotropic mixtures. *AIChE J*. 2003;49:3074 – 3083.
11. Modla G, Lang P, Molnar K. Batch Heteroazeotropic Rectification of a Low Relative Volatility Mixture under Continuous Entrainer Feeding: Feasibility Studies. CD-Rom Proceedings of 6th World Congress of Chemical Engineering, Melbourne, Australia, 2001.
12. Pham HN, Doherty MF. Design and Synthesis of Heterogeneous Azeotropic Distillations - III. Column Sequence. *Chem Eng Sci*. 1990;45:1845-1854.
13. Ryan PJ, Doherty MF. Design/optimization of ternary heterogeneous azeotropic distillation sequences. *AIChE J*. 1989;35:1592-1601.
14. Bausa JR, Watzdorf V, Marquardt W. Shortcut Methods for Nonideal Multicomponent Distillation: 1. Simple Columns. *AIChE J*. 1998;44:2181-2198.
15. Urdaneta RY, Bausa J, Bruggemann S, Marquardt W. Analysis and Conceptual Design of Ternary Heterogeneous Azeotropic Distillation Processes, *Ind Eng Chem Res*. 2002;41:3849 - 3866.
16. Brüggemann S, Marquardt W. Shortcut methods for nonideal multicomponent distillation: 3. Extractive distillation columns. *AIChE J*. 2004;50:1129-1149.

17. Prosim SA. <http://www.prosim.net>. 2003.
18. Acosta-Esquivarosa, J, Arce A, Rodil E, Soto A. Thermodynamic study on binary and ternary mixture of acetonitrile – water – butyl acetate. *Fluid Phase Equilibria*. 2002;203:83-98.
19. Pham HN, Ryan PJ, Doherty MF. Design and minimum reflux for heterogeneous azeotropic distillation columns. *AIChE J*. 1989;35:1585-1591.
20. Knapp JP, Doherty MF. Minimum entrainer flow for extractive distillation: a bifurcation theoretic approach. *AIChE J*. 1994;40:243-268.
21. Frits ER, Lelkes Z, Fonyo Z, Rev E, Markot MCs. Finding limiting flows of batch extractive distillation with interval arithmetics. *AIChE J*. 2006;52:3100-3108.
22. Pallai I, Fonyó Z (eds.), Studies in computer-aided modelling, design and operation, part A: Unit Operations, Amsterdam: Elsevier, 1992.

FIGURES ARE ALSO PROVIDED AS SEPARATED TIFF FILES

TABLES ARE FOUND AT THE END OF THE MANUSCRIPT, AFTER THE FIGURES.

FIGURE CAPTION

- Figure 1. Thermodynamic and topological properties of the residue curve map of the acetonitrile – water – butyl acetate mixture
- Figure 2. Typical column sequence for the heterogeneous continuous distillation process. (A) Pre-concentrator, (B) Heterogeneous Distillation Column, (C) Entrainer Recovery Column.
- Figure 3. Superstructure for the heterogeneous distillation column considering all possibilities for both the entrainer recycle and the main azeotropic feed.
- Figure 4. Combined options for entrainer recycle stream and the main azeotropic feed stream in the top part of the heterogeneous column considering that they can be supplied to the decanter or mixed with the reflux.
- Figure 5. Map of rectifying composition profiles computed from several x_R points, and the stripping composition profile computed from x_W , for the heterogeneous continuous distillation (configuration 1).
- Figure 6. Rectifying, extractive, and stripping liquid composition profiles for the heterogeneous extractive continuous distillation process (configuration 2).
- Figure 7. Stripping liquid composition profile and map of extractive composition profiles for heterogeneous distillation using column configuration 3.
- Figure 8. Projection of the valid line of x_0 toward point x_F for column configuration 4.
- Figure 9. Stripping composition profile and line of valid value of x_0 for variants A, B and C for column configuration 4.
- Figure 10. Stripping liquid composition profile and map of extractive composition profiles for feeding the entrainer recycled stream into the decanter, and the main azeotropic feed at an intermediate point of the column (configuration 5).
- Figure 11. Stripping and extractive composition profiles when the main azeotropic stream is fed at intermediate point of the column, and both the entrainer recycle stream and a portion of distillate are sent to the decanter (configuration 6).
- Figure 12. Stripping composition profile for column configuration 7 considering two operating conditions: Variant A ($F_E=2$, $R=10$) and Variant B ($F_E=6.5$, $R=30$).

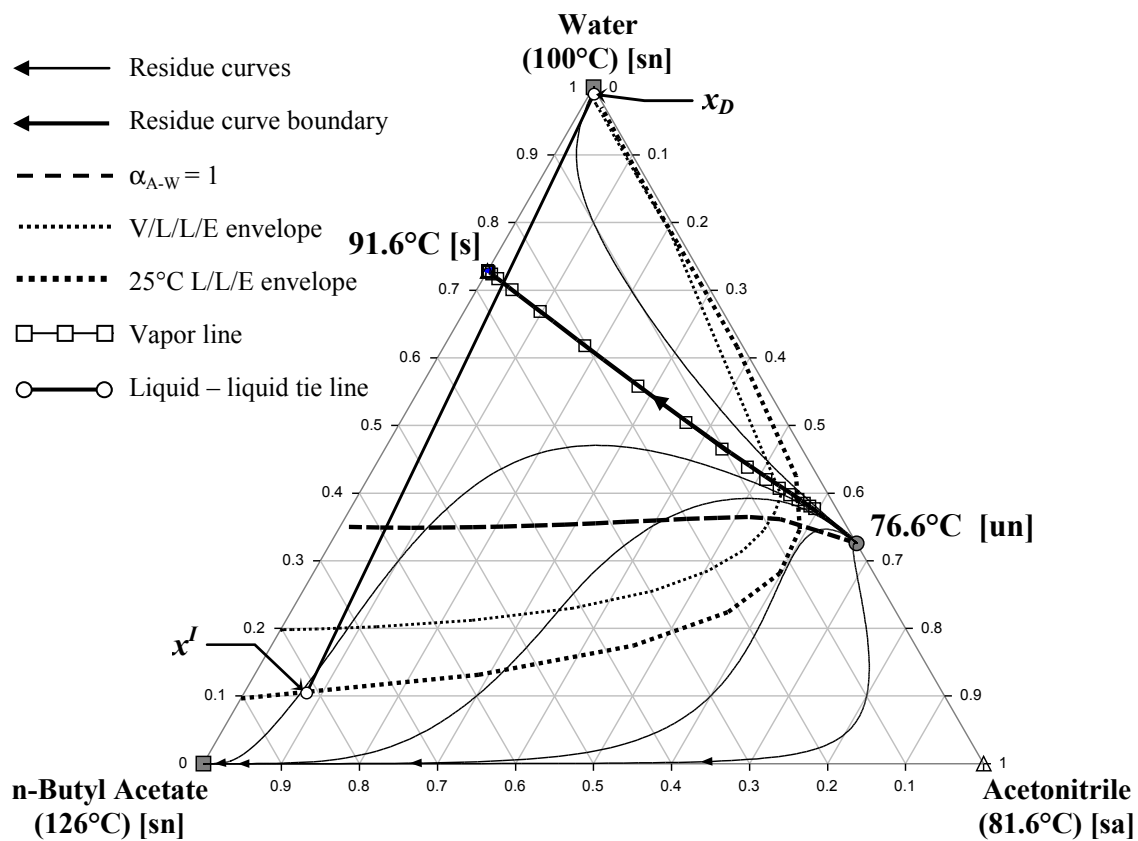

Figure 1. Thermodynamic and topological properties of the residue curve map of the acetonitrile – water – butyl acetate mixture.

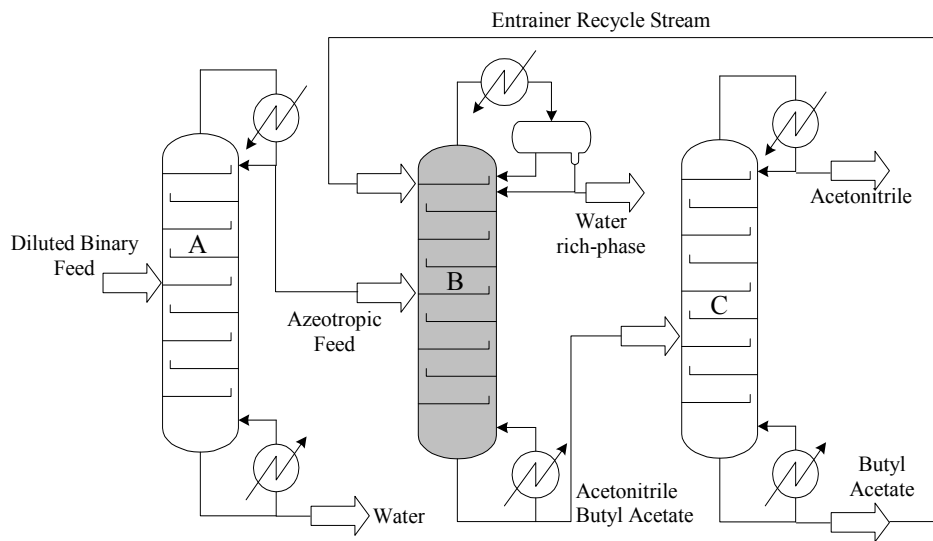

Figure 2. Typical column sequence for the heterogeneous continuous distillation process. (A) Pre-concentrator, (B) Heterogeneous Distillation Column, (C) Entrainer Recovery Column.

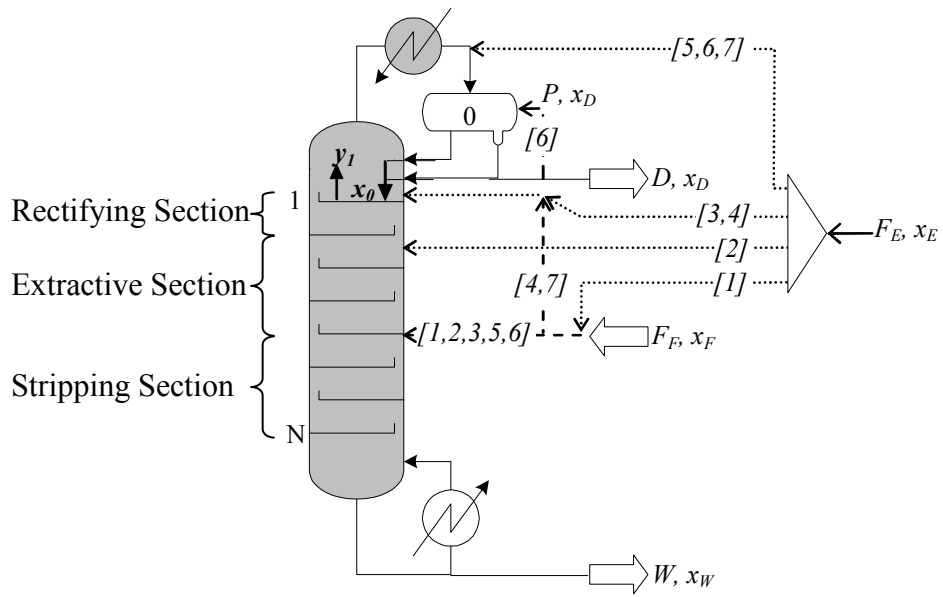

Figure 3. Superstructure for the heterogeneous distillation column considering all possibilities for both the entrainer recycle and the main azeotropic feed.

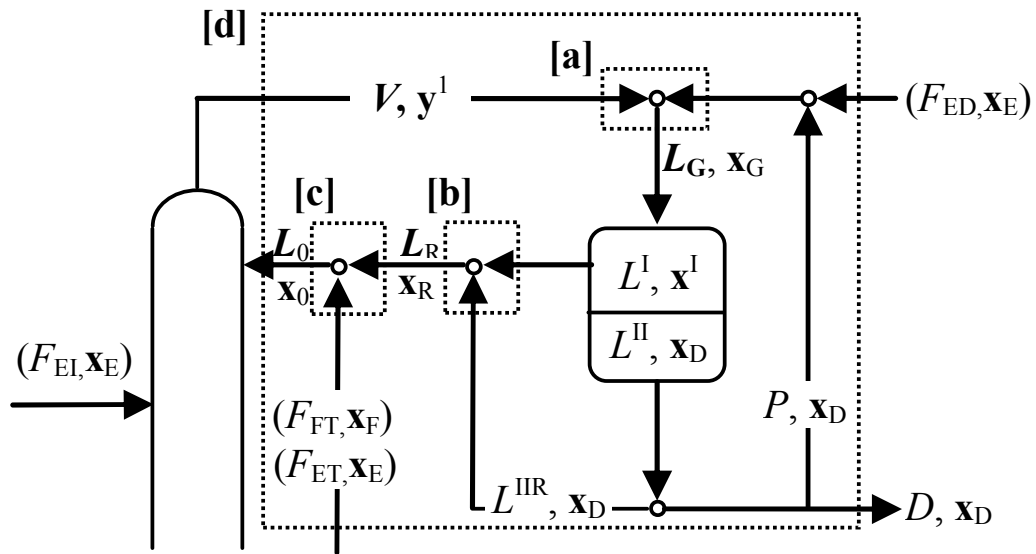

Figure 4. Combined options for entrainer recycle stream and the main azeotropic feed stream in the top part of the heterogeneous column considering that they can be supplied to the decanter or mixed with the reflux.

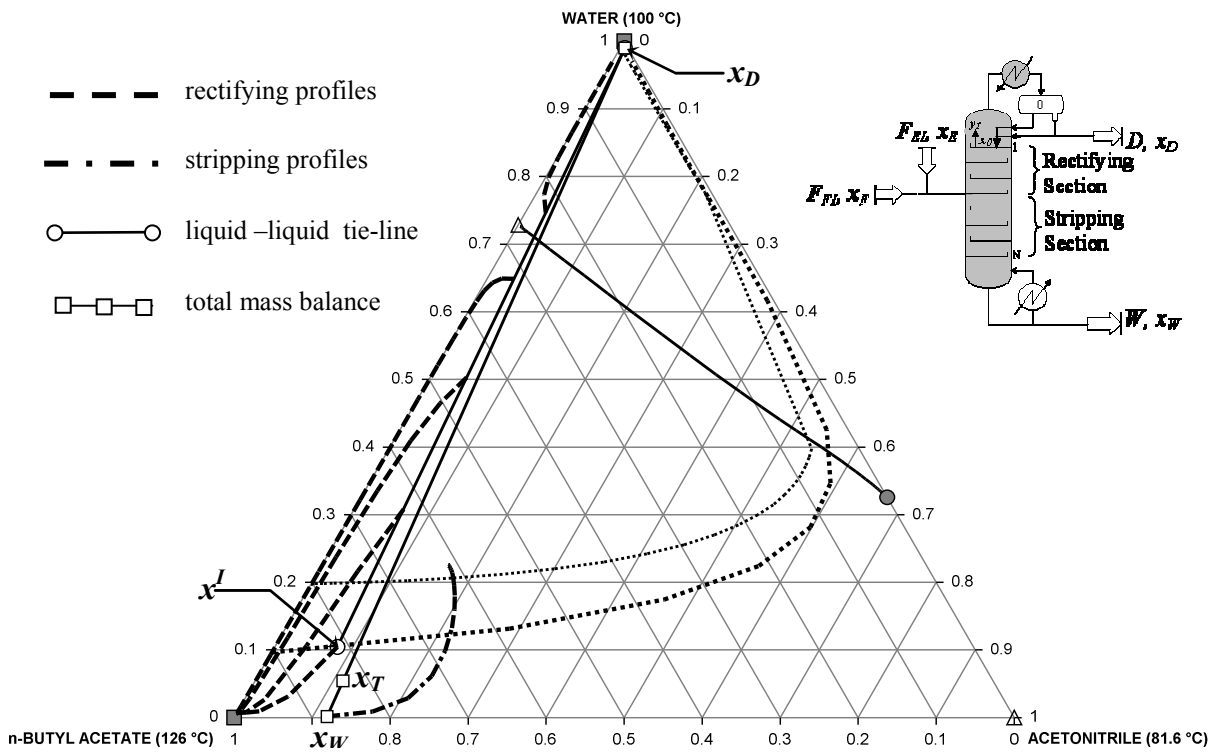

Figure 5. Map of rectifying composition profiles computed from several x_R points, and the stripping composition profile computed from x_W , for the heterogeneous continuous distillation (configuration 1).

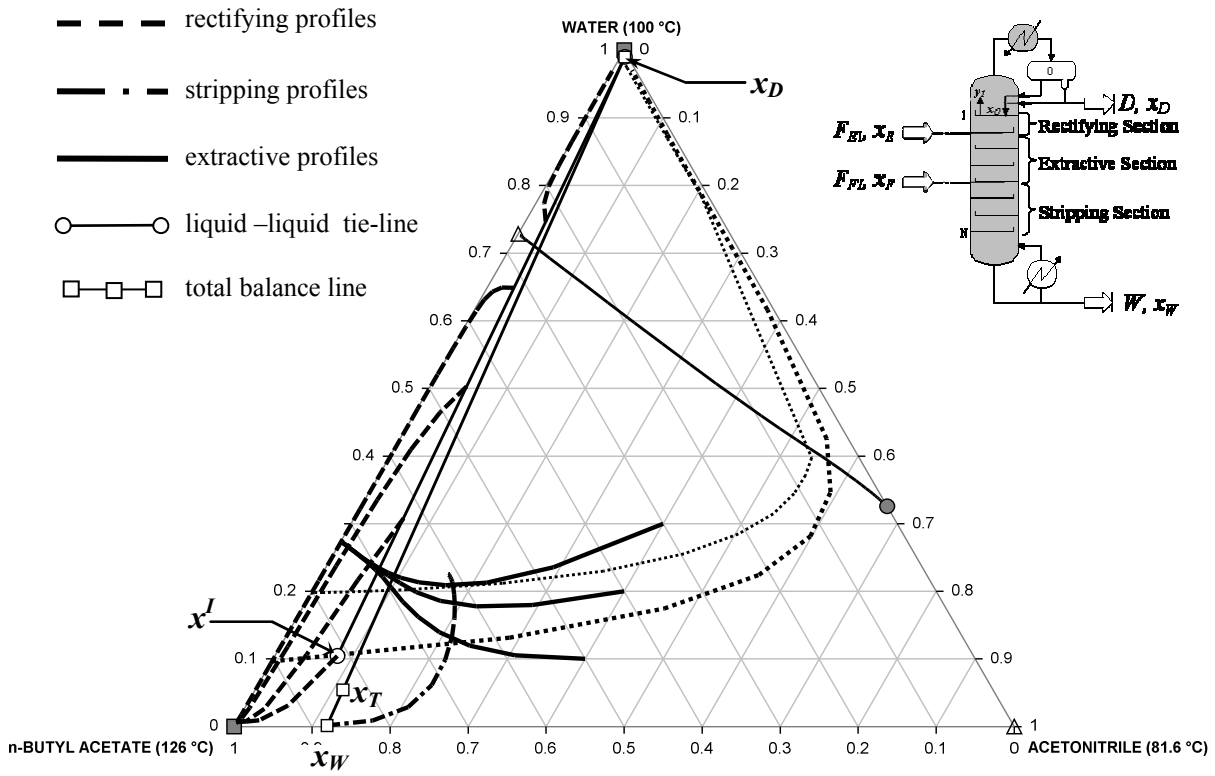

Figure 6. Rectifying, extractive, and stripping liquid composition profiles for the heterogeneous extractive continuous distillation process (configuration 2).

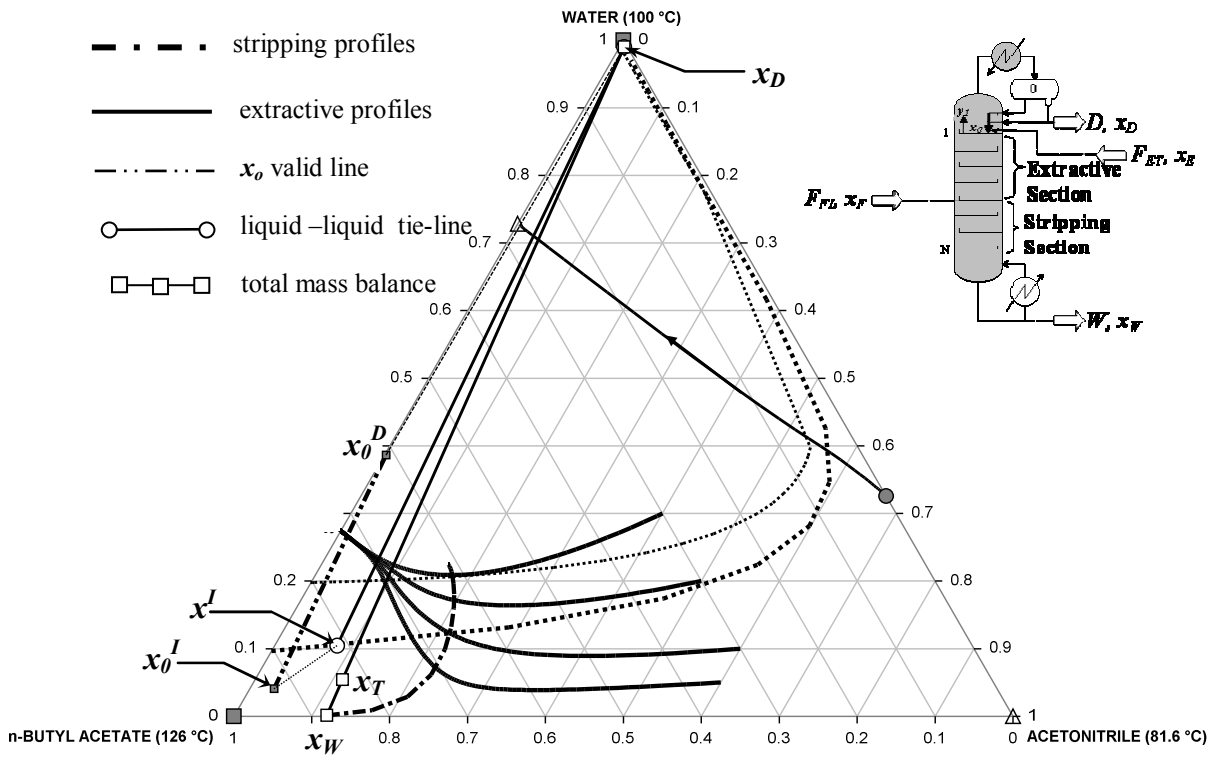

Figure 7. Stripping liquid composition profile and map of extractive composition profiles for heterogeneous distillation (configuration 3).

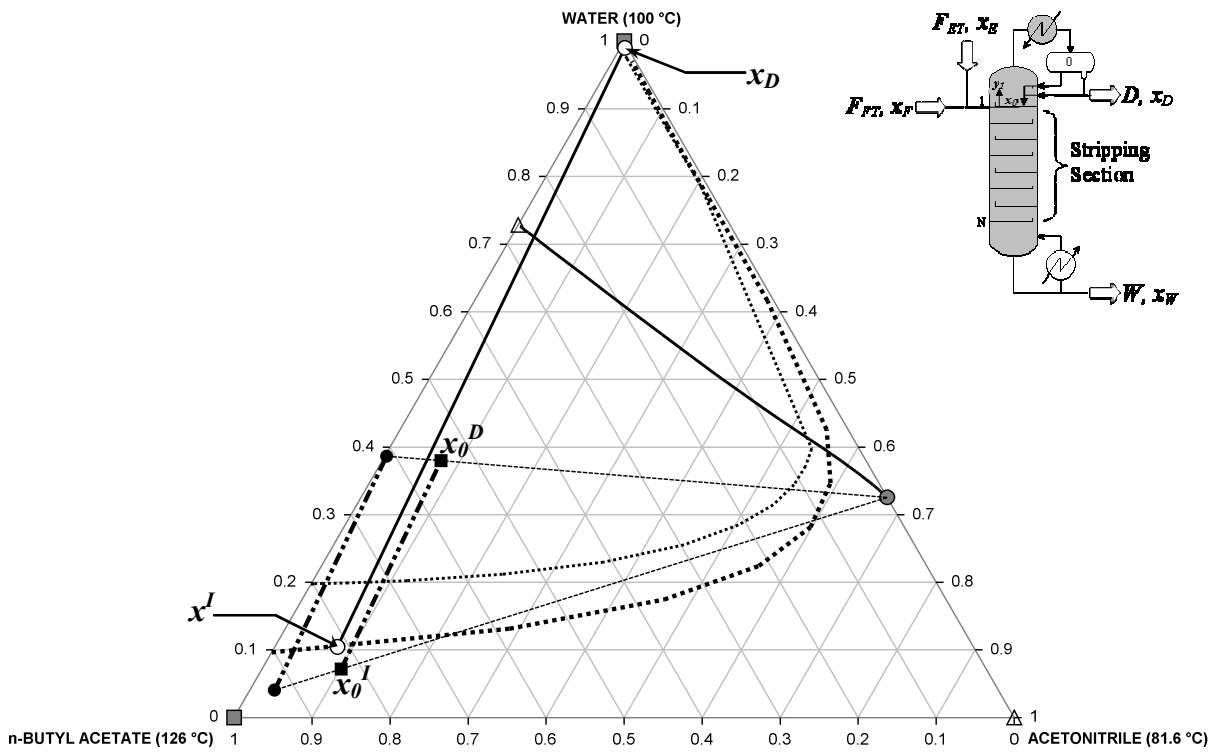
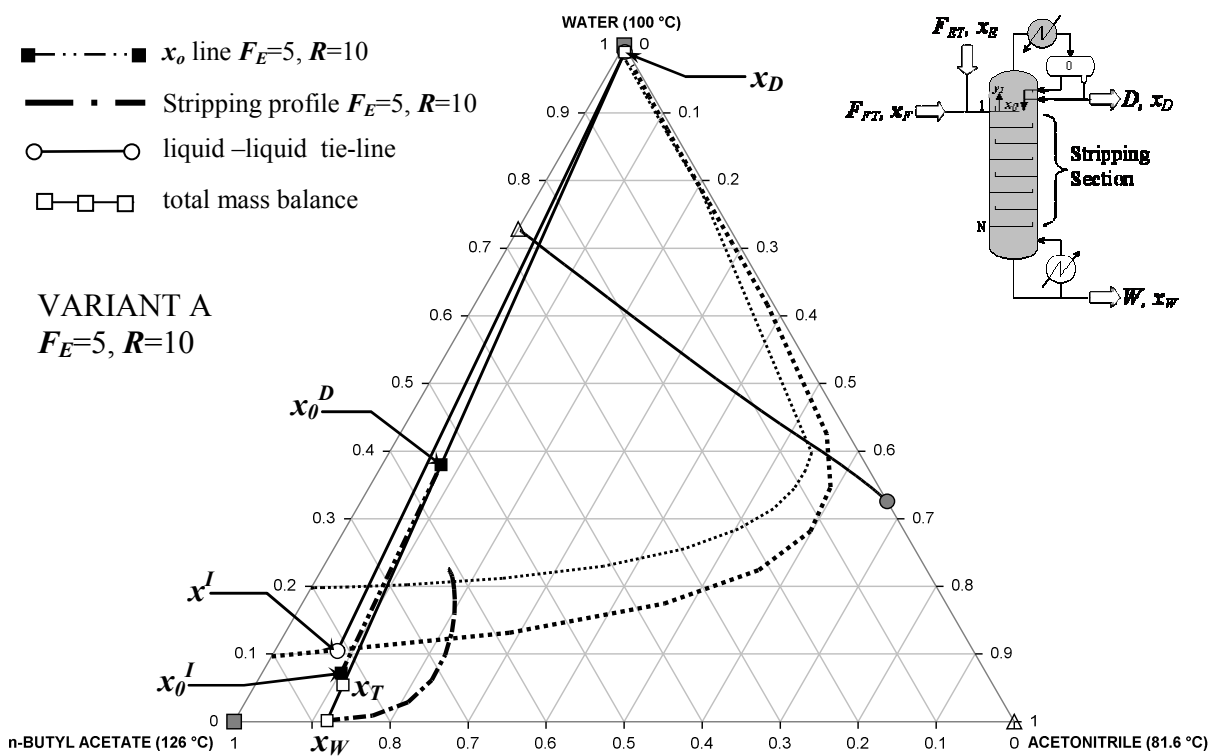
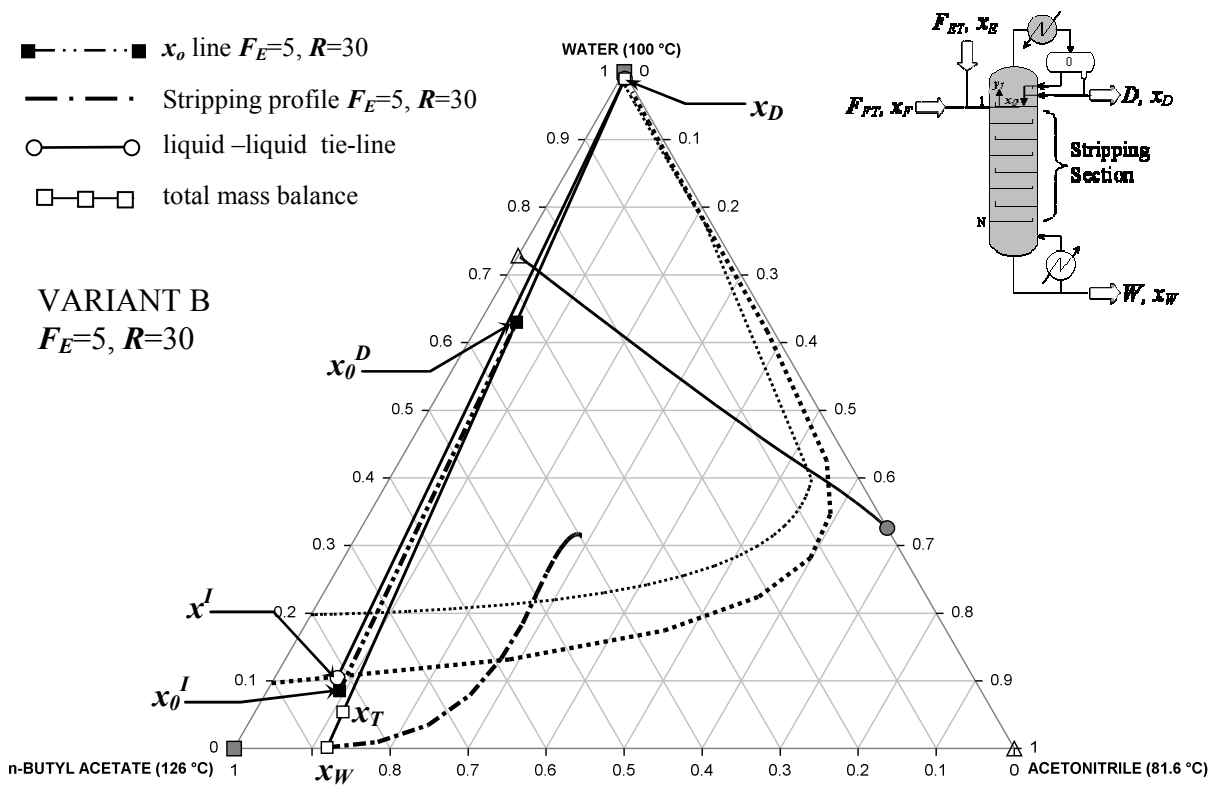

Figure 8. Projection of the valid line of x_0 toward point x_F for column configuration 4.



Part of figure 9



Part of figure 9

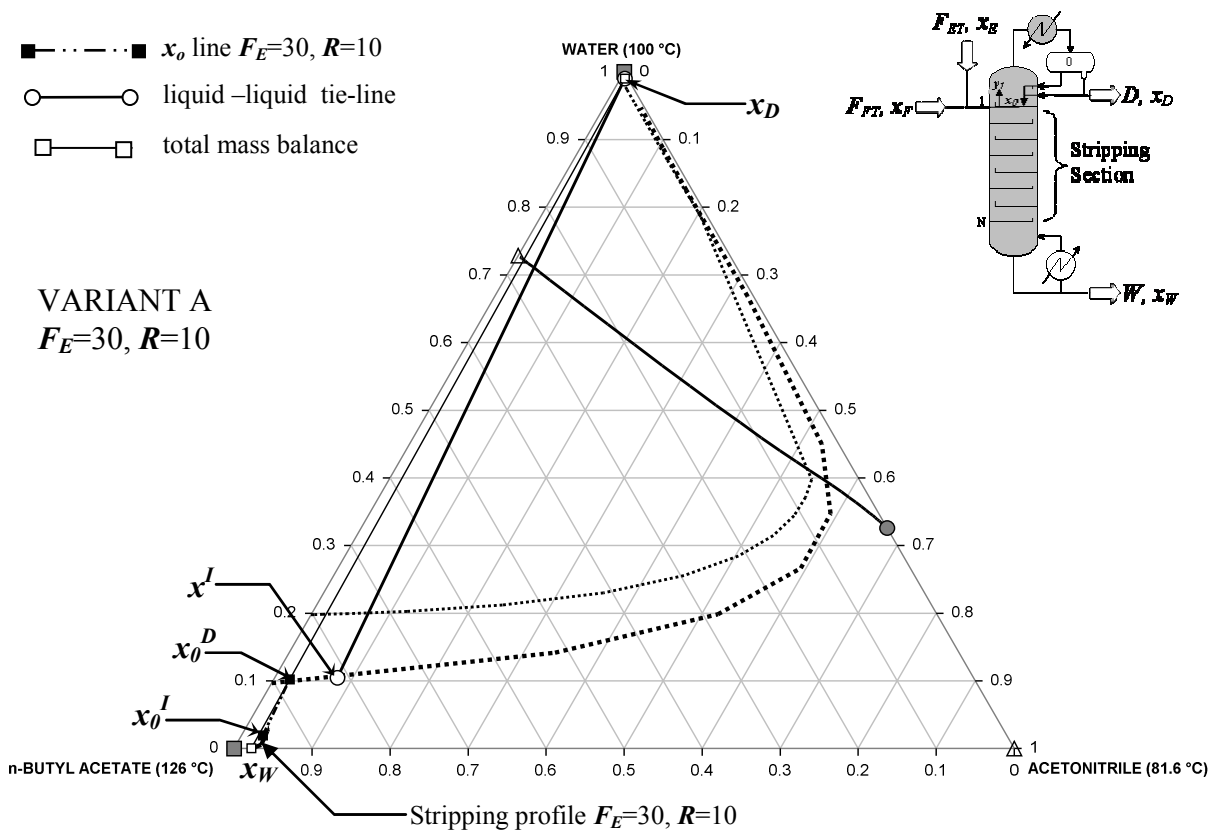

Figure 9. Stripping composition profile and line of valid value of x_0 for variants A, B and C for column configuration 4.

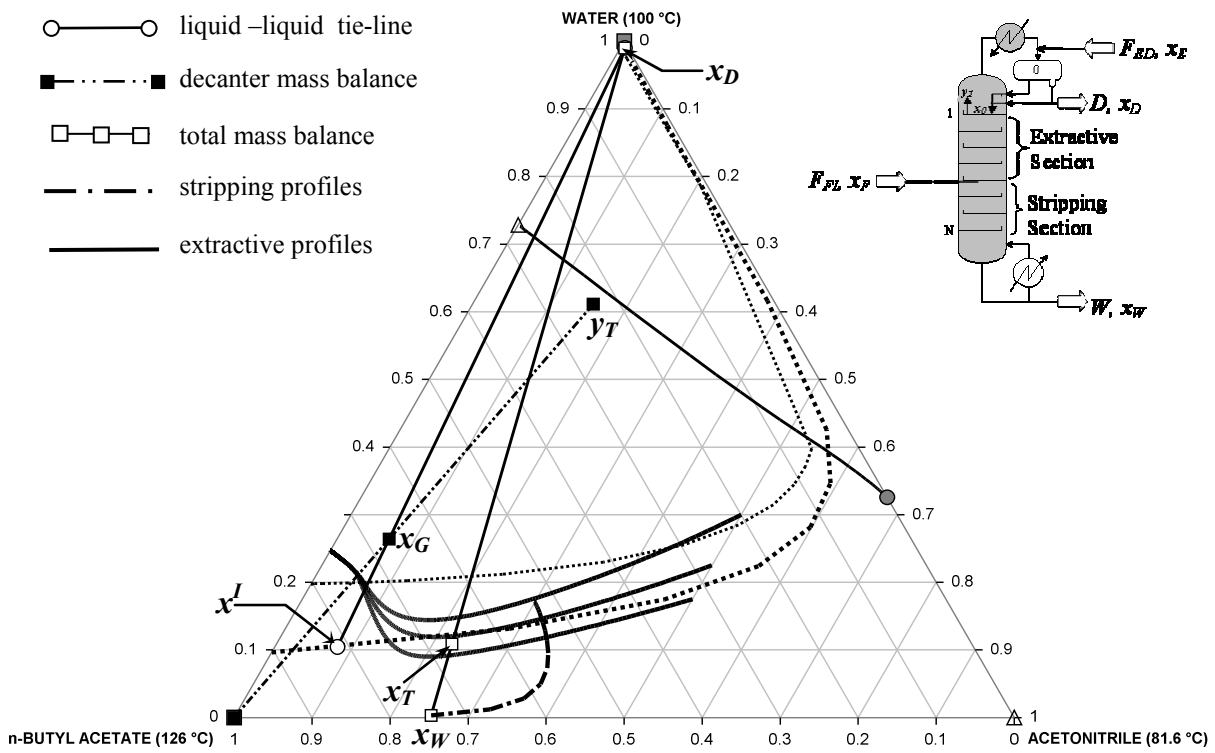

Figure 10. Stripping liquid composition profile and map of extractive composition profiles for feeding the entrainer recycled stream into the decanter, and the main azeotropic feed at an intermediate point of the column (configuration 5).

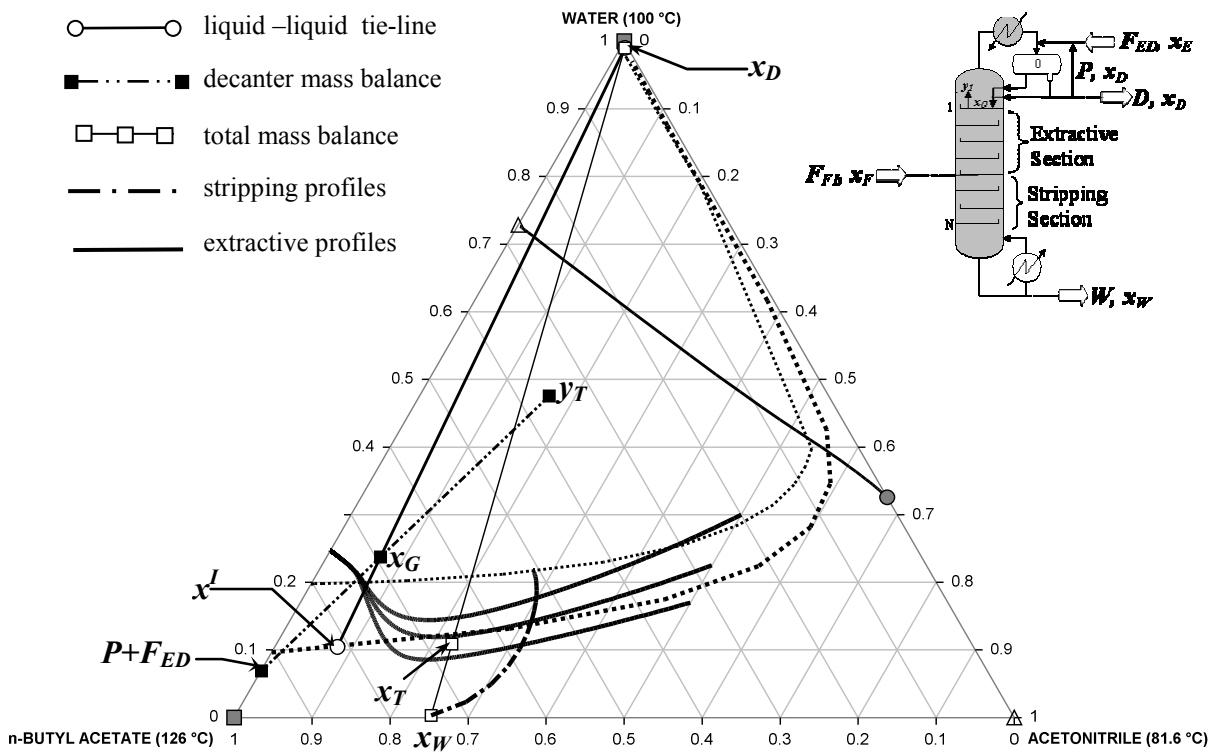
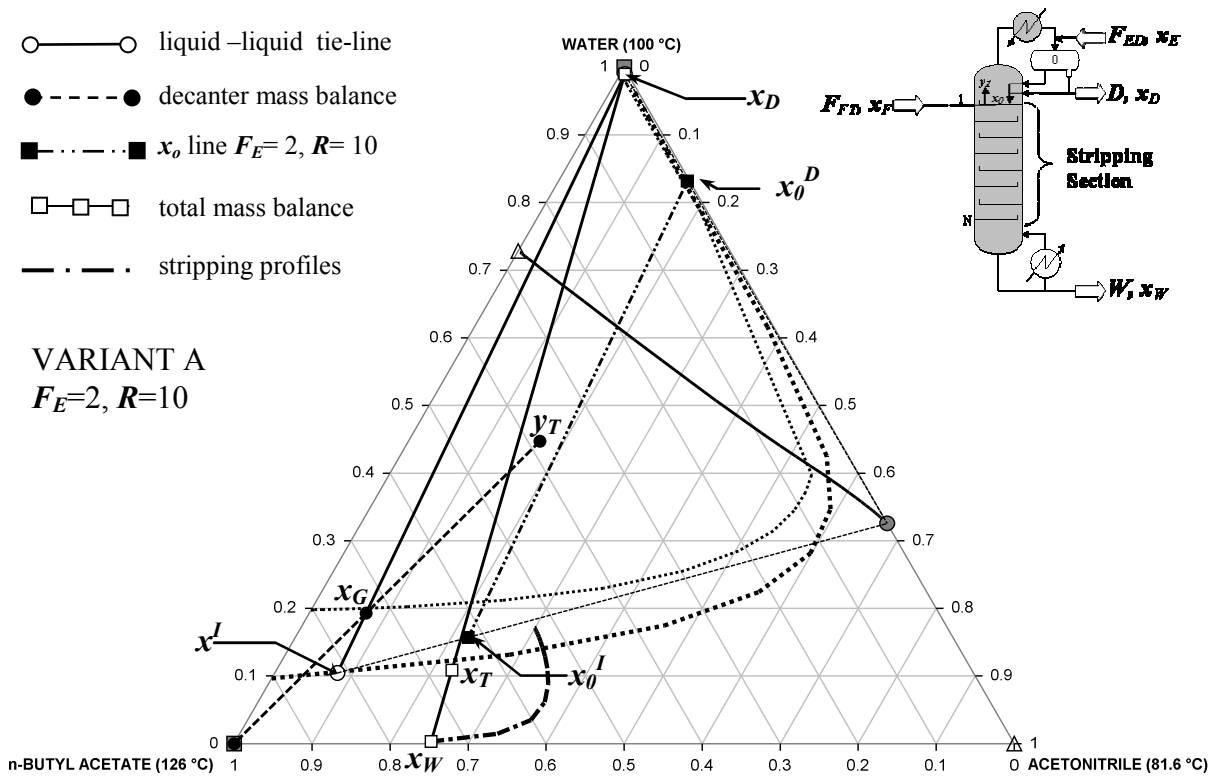

Figure 11. Stripping and extractive composition profiles when the main azeotropic stream is fed at intermediate point of the column, and both the entrainer recycle stream and a portion of distillate are sent to the decanter (configuration 6).



Part of figure 12

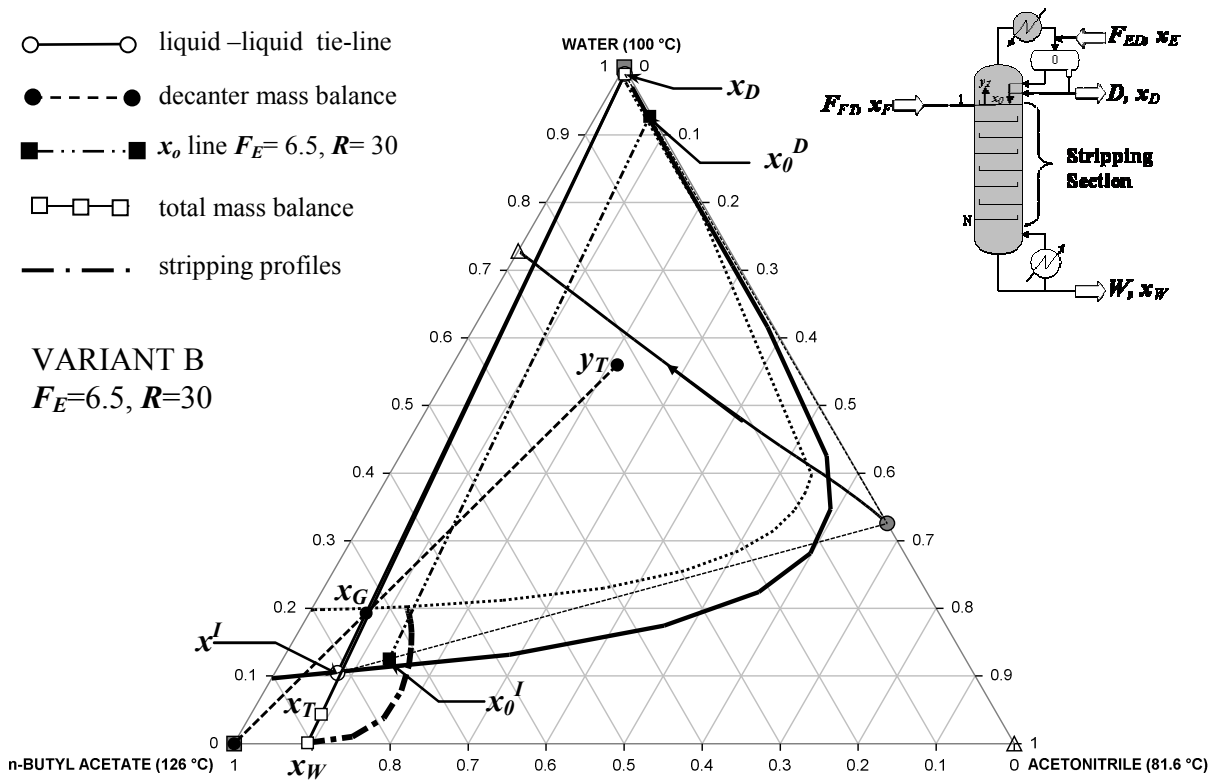

Figure 12. Stripping composition profile for column configuration 7 considering two operating conditions: Variant A ($F_E=2, R=10$) and Variant B ($F_E=6.5, R=30$).

TABLE CAPTION

Table 1. Binary coefficients for calculation of phase equilibria by using NRTL model

Table 2. Operating conditions for the heterogeneous extractive continuous distillation configurations

Table 1. Binary coefficients for calculation of phase equilibria by using NRTL model

L/L/V	A_{ij}	A_{ji}	α_{ij}	298K	A_{ij}	A_{ji}	α_{ij}
	[cal/mol]	[cal/mol]		L/L	[cal/mol]	[cal/mol]	
A – B	-236.4	1796.4	0.1	A – B	440.83	865.18	0.2
A – C	1710.94	-1180.02	0.1	A – C	-212.12	-177.67	0.2
B – C	4696.44	-1114.22	0.1	B – C	2865.4	477.67	0.2

Table 2. Operating conditions for the heterogeneous extractive continuous distillation configurations.

Operating parameters	[Configuration] and variant								
	[1]	[2]	[3]	[4] A	[4] B	[4] C	[5]	[6]	[7] B
F_{FI} (mol.s ⁻¹)		1.0			0.0			1.0	0.0
F_{FT} (mol.s ⁻¹)		0.0			1.0			0.0	1.0
x_F					[0.6743; 0.3257; 0.0000]*				
F_{EI} (mol.s ⁻¹)	5.0					0.0			
F_{ET} (mol.s ⁻¹)	0.0			5.0		30.0		0.0	
F_{ED} (mol.s ⁻¹)				0.0				2.0	6.5
x_E					[0.0; 0.0; 1.0]*				
F_T (mol.s ⁻¹)			6.0			31.0		3.0	7.5
x_T			[0.1124; 0.0543; 0.8333]*			[0.0217; 0.0105; 0.9677]*	[0.2248; 0.1087; 0.6667]*	[0.2143; 0.1505; 0.6351]*	[0.0899; 0.0434; 0.8667]*
D (mol.s ⁻¹)					0.32				
P (mol.s ⁻¹)				0.0				0.15	0
x_D					[0.0058; 0.9900; 0.0041]*				
x^I					[0.0802; 0.1045; 0.8153]*				
W (mol.s ⁻¹)			5.68			30.68		2.68	7.18
x_W			[0.1184; 0.0016; 0.8800]*			[0.0219; 0.0003; 0.9778]		[0.2509; 0.0033; 0.7458]*	[0.0936; 0.0012; 0.9051]*
V (mol.s ⁻¹)			3.52		9.92	3.52		1.52	3.42
L_G (mol.s ⁻¹)			3.52		9.92	3.52	3.52	3.67	9.92
ω_{max}			0.9091		0.9677	0.9091	0.9091	0.9128	0.9677
L_R (mol.s ⁻¹)			3.2		9.6		3.2		9.6
L_E (mol.s ⁻¹)	-		8.2		-	-		3.2	-
L_w (mol.s ⁻¹)			9.2		15.6	34.2		4.2	10.6
R			10.0		30.0		10.0		30.0

Operating parameters	[Configuration] and variant				
	[1]	[2]	[3]	[4] A	[4] B
F_{FI} (mol.s ⁻¹)		1.0			0.0
F_{FT} (mol.s ⁻¹)		0.0			1.0
x_F					[0.6743; 0.3257; 0.0000]*
F_{EI} (mol.s ⁻¹)	5.0				
F_{ET} (mol.s ⁻¹)	0.0			5.0	
F_{ED} (mol.s ⁻¹)				0.0	
x_E					[0.0; 0.0; 1.0]*
F_T (mol.s ⁻¹)			6.0		
x_T			[0.1124; 0.0543; 0.8333]*		[0.021]
D (mol.s ⁻¹)					0.32
P (mol.s ⁻¹)				0.0	
x_D					[0.0058; 0.9900; 0.0041]*
x^J					[0.0802; 0.1045; 0.8153]*
W (mol.s ⁻¹)			5.68		
x_W			[0.1184; 0.0016; 0.8800]*		[0.021]
V (mol.s ⁻¹)			3.52		9.92
L_G (mol.s ⁻¹)			3.52		9.92
ω_{max}			0.9091		0.9677
L_R (mol.s ⁻¹)			3.2		9.6
L_E (mol.s ⁻¹)	-		8.2		-
L_w (mol.s ⁻¹)			9.2		15.6
R			10.0		30.0

*molar composition vector order is [acetonitrile; water; butyl acetate]