



**HAL**  
open science

# A Passive Mixer for 60 GHz Applications in CMOS 65nm Technology

Mariano Ercoli, Michael Kraemer, Daniela Dragomirescu, Robert Plana

► **To cite this version:**

Mariano Ercoli, Michael Kraemer, Daniela Dragomirescu, Robert Plana. A Passive Mixer for 60 GHz Applications in CMOS 65nm Technology. German Microwave Conference 2010, Mar 2010, Berlin, Germany. hal-00464925

**HAL Id: hal-00464925**

**<https://hal.science/hal-00464925>**

Submitted on 18 Mar 2010

**HAL** is a multi-disciplinary open access archive for the deposit and dissemination of scientific research documents, whether they are published or not. The documents may come from teaching and research institutions in France or abroad, or from public or private research centers.

L'archive ouverte pluridisciplinaire **HAL**, est destinée au dépôt et à la diffusion de documents scientifiques de niveau recherche, publiés ou non, émanant des établissements d'enseignement et de recherche français ou étrangers, des laboratoires publics ou privés.

# A Passive Mixer for 60 GHz Applications in CMOS 65nm Technology

Mariano Ercoli<sup>\*\*</sup>, Michael Kraemer<sup>\*\*</sup>, Daniela Dragomirescu<sup>\*\*</sup>, Robert Plana<sup>\*\*</sup>

<sup>#</sup>CNRS; LAAS; 7 avenue du colonel Roche, F-31077 Toulouse, France

\* University of Toulouse ; UPS, INSA, INP ISAE; LAAS; F-31077 Toulouse, France

mercoli@laas.fr; mkraemer@laas.fr; daniela@laas.fr; plana@laas.fr

**Abstract** — A study of the feasibility of a wide band double balanced resistive mixer in the 60 GHz band is done. The device is implemented in a 65nm CMOS technology process. In this paper an approach to design an optimized version of the mixer in terms of the principal figures of merit: conversion loss, port to port isolation and noise figure is shown. The mixer will be a part of an homodyne down-conversion system. The conversion loss is  $6.9 \pm 0.2$  dB around 60GHz with a  $-5$  dBm of LO drive. The port-to-port isolation for the LO feed through is better than 41dB. The noise figure is 8.39dB. The power dissipation for the mixer depends on the LO buffer that increases the input LO power. Its power consumption is 15mW.

**Keywords** — Passive Mixer, Homodyne receivers, 60GHz Band, Low Power, CMOS, Direct Conversion.

## I. INTRODUCTION

The unlicensed frequency band around 60GHz is today at the center of the research community interest. There are many applications proposed in this band and the request for cheap circuit is rising. Silicon-based technologies, with their inexpensive production cost and a continuous reduction of channel dimension, become an attractive alternative for the realization of millimeter-wave integrated circuits. This technological process moreover offers a high-level integration capability for high-frequency front-end circuitry with the chance to integrate analog and digital blocks on a single chip.

The optimization of the basic building blocks is an important objective. In particular, it is important to take into account the parasitic phenomena that occur at millimeter waves. For the receiver circuitry the choice of the mixer's architecture is very important, because it influences the entire down-conversion chain. Heterodyne systems employ two consecutive stages of down-conversion, while the homodyne system requires only one mixer. In the second case the complexity of the system is lower. The direct down-conversion however has drawbacks. The typical issues are the DC voltage offset and strong flicker noise. These phenomena are particularly remarkable on a classical active architecture: the Gilbert cell mixer. Another problem of the active mixer configuration is the linearity. This aspect is accentuated by

the low voltage supply for sub-micrometer devices [1]. An alternative approach can be the use of a passive mixer. This architecture allows a very good linearity, suitable for high dynamic range receiver design, [2] and a very limited flicker noise effect, due to the absence of channel DC bias current. Moreover, the passive mixer has a simple architecture and zero power dissipation. The disadvantage of this class of frequency converter is their conversion loss.

This paper analyses a lot of the factors that determine the passive mixer behavior. The design of the mixer was done with the concurrent evaluation of the conversion gain, linearity, noise figure, and power dissipation.

The presence of a local oscillator (LO) buffer stage is justified by the requirement for large LO amplitudes to drive the switch system. This is done to avoid the increase of the conversion loss.

## II. CONSIDERATION CONCERNING THE BEHAVIOR OF THE SWITCHES

An ideal configuration for a double balanced passive mixer is shown in Figure 1. Intermediate Frequency (IF), Radio Frequency (RF) and LO ports are indicated.

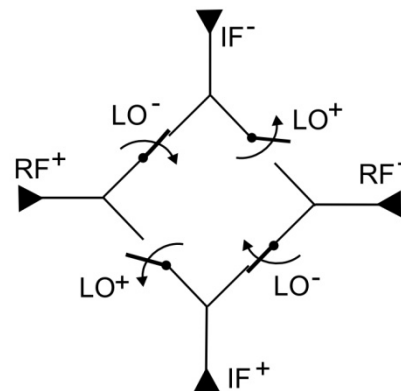

Figure 1: Ideal passive mixer composed by four switches driven by a balanced local oscillator

In the ideal case, the switches are controlled by a LO square wave signal. The transfer function of the ideal

system, based on the down-conversion voltage gain, is [1] then

$$G_c = \frac{\text{Output Signal Level}(IF)}{\text{Input Signal Level}(RF)} = \frac{2}{\pi} \quad (1)$$

Therefore, for an ideal dual balanced passive mixer the minimum conversion loss is around 4 dB.

This value, however, neglects many parasitic effects that affect the real transistor and the interconnection networks. The problem of the different behavior between an ideal switching device and a real MOS switch is discussed in [2]. In that paper it is shown that the voltage-gain of a mixer is in strict relation with the allowed minimum  $R_{ON}$  and the allowed maximum  $Z_{OFF}$ :

$$G_c = 20 \log_{10} \left[ \frac{2}{\pi} \left( \frac{Z_L}{Z_L + R_{ON} || Z_{OFF}} \right) - \frac{2}{\pi} \left( \frac{Z_L}{Z_L + Z_{OFF}} \right) \right] \quad (2)$$

An important variable in the  $R_{ON}$  and  $Z_{OFF}$  definition is the geometrical parameter " $W_t$ ". The minimum gate resistance

$$R_{ON} = \frac{L_g}{\mu_n C_{OX} W} \left( (V_g - g_c v_{RF}) - V_{th} - V_{ds} \right) Z_L \quad (3)$$

is inversely proportional to the gate width ( $W_t$ ). So, for a low channel resistance, the value of  $W_t$  has to be very high. Note that the gate length ( $L_g$ ) is set to the minimum value allowed by the technology (here 65nm) in order to maximize  $f_{MAX}$  and  $f_T$ .

Regarding the  $Z_{OFF}$  impedance,  $W_t$  determines the amount of parasitic capacitance that causes a drop of the total off-impedance. The estimation of an optimum value of  $W_t$  is critical to establish the best trade-off between  $R_{ON}$  and  $Z_{OFF}$ . For the off-state of the MOS, the impedance is represented by a high channel resistance and a set of parasitic capacitances, as shown in Figure 2.

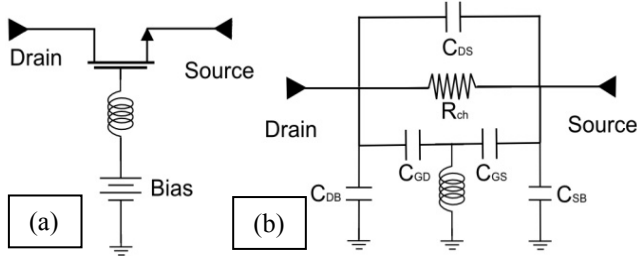

Figure 2: Equivalent circuit for a switch in off-state. A negative value (-0.5V) of bias voltage is imposed to well simulate the off-state of the switch.

In off-state,  $R_{ch}$  shows a high value due to the depletion of the channel. The drop of the total  $Z_{OFF}$  impedance is caused by the connection of the capacitance  $C_{DS}$  and the influence of the parasitics  $C_{GD}$ ,  $C_{GS}$ ,  $C_{DB}$  and  $C_{GB}$ . This parasitic effect is linearly proportional to the transistor's width  $W_t$ . Figure 3 shows the fitting curves of the equivalent circuit (named on Figure 3 *Eq-Circ*) versus the real CMOS device, (named on Figure 3 *Sim*) in terms of

the  $S_{21}$  parameter. The data are represented for four different transistor dimensions ( $W_t = 35, 50, 80$  and  $96 \mu m$ ). For the real CMOS transistor the simulations were done using the complete model of the transistor, including the parasitic elements of the real device, Figure 2(a). The good matching of the curves demonstrates the validity of the equivalent circuit and its quality.

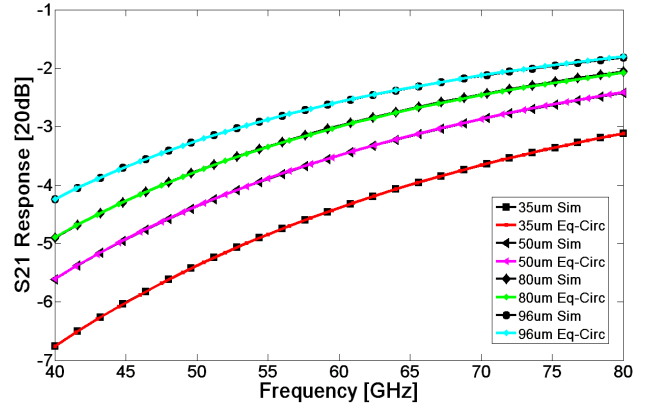

Figure 3:  $S_{21}$  values for the real transistor and equivalent circuit.

The graph on Figure 3 underlines the strong influence of the parasitic capacitance. The Drain-Source isolation falls with the rise of  $W_t$ . In the 60GHz band, the value of the capacitance builds a low impedance path for the RF signals. Figure 4 reports the variation of value for the principal parameters in the equivalent circuit versus the device size ( $W_t$ ). The non-perfect linearity for the value is caused by different realizations, in terms of finger number ( $N_f$ ), single finger width ( $W_f$ ) and metal interconnection geometry. For the resistance, instead, the linearity is respected because it depends only on the dimension  $W_t$ .

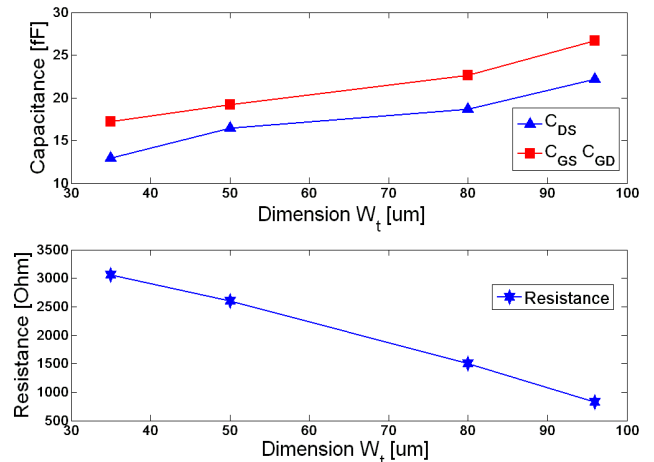

Figure 4: Capacitance and resistance variation versus device size.

To establish a consistent value for the capacitance on the equivalent circuit, the evaluation of  $C_{GS}$  and  $C_{GD}$  have been made following the guidelines proposed in [3]. The  $R_{ch}$ ,  $C_{DS}$ ,  $C_{DB}$  and  $C_{SB}$  are utilized like a variable parameter to fit the MOSFET's simulated curve. Thanks

TABLE I

State of the Art Passive Mixer					
Papers #	Freq	Conv. Loss min	LO Power Drive	NF	Isolation
[4]	900 MHz	4.7dB	+7dBm	6.5dB	NA
[10]	0.9÷1.8 GHz	5.8 dB	14 dBm	5.8	43dB
[12]	5÷6 GHz	6 dB	0 dBm	NA	45 dB
[6]	3GHz	6÷6,5 dB	+7dBm	NA	45dB
<b>This work</b>	<b>60GHz</b>	<b>6.9±0.2 dB</b>	<b>-5 dBm</b>	<b>8.39 dB</b>	<b>41 dB</b>
[7]	5 GHz	7 dB	0 dBm	8	45dB
[8]	19÷26.5GHz	7.6 dB	6 dBm	NA	28dB
[5]	11GHz	7±0.5 dB	+9dBm	7.5dB	37±1dB
[11]	2.4 GHz	7.8 dB	10 dBm	NA	48 dB
[9]	26.5÷30 GHz	10 dB	0 dBm	11.4	33dB

to this procedure it was possible to evaluate the effects that the capacitance variation has on the behavior of the MOSFET switch at 60GHz. In conclusion, a tradeoff has to be done between  $R_{ON}$  and  $Z_{OFF}$ . The realization of large devices allows to minimize the  $R_{ON}$  resistance but the parasitic capacitance lead nevertheless to a  $Z_{OFF}$  degradation. In this case the best compromise achieved to realize a 60GHz passive mixer, is to employ a 50um wide device. This value of  $W_t$  is a good trade-off between  $R_{ON}$  and  $Z_{OFF}$ .

### III. MIXER REALIZATION

The mixer design flow is thought to achieve the minimum conversion loss together with a limited LO drive. The literature shows that this compromise is not an easy target. Table 1 summarizes the state-of-the-art for the passive CMOS mixer design. A lot of this devices work at lower frequencies (0.9-5GHz) and only 2 configurations are employed in K band. Different technologies like SiGe or GaAs are used for this type of architecture, but these processes are more expensive in mass production. Moreover another significant aspect is that CMOS has a lower power requirement compared to the other technologies.

The layout's optimization has been made through the simulation of its conversion gain. The layout of the single transistor is done to minimize the phase difference of the signal at the gate.

This precaution has bound the transistor's finger width  $W_f$  to 2.5um and it guarantees the optimal signal distribution and a very compact device core. Thanks to this approach, the port-to-port isolation and the inductive degeneration due to connection lines are limited. A simulation of the transfer function of the device is shown in Figure 5.

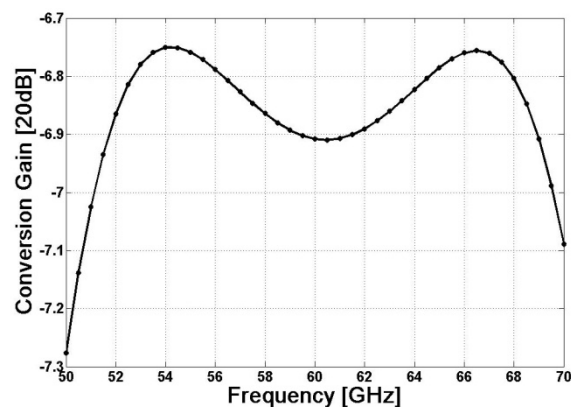

Figure. 5: Mixer's Conversion Gain for a LO power level of -5dBm.

### IV. MATCHING NETWORK

The work on the matching networks component requires particular attention. The conversion loss of the mixer in fact is very susceptible to the parasitic resistance of the matching inductor. This phenomenon is particularly critical on the high frequency path (RF and LO shunt inductor). To decrease this effect, a combination of lumped elements and transmission lines were used to achieve an acceptable trade off for the matching elements. However the drop of the conversion loss is 1.8dB higher with respect to the ideal behavior. The return loss for the LO and the RF port is better than -13dB in the band of interest. The port-to-port isolation for the LO feed through is better than 40dB for the center frequency of 60GHz. The simulated noise figure ( $NF_{DSB}$ ) for the structure is 8.39dB. In Figure 6 is shown the variation of  $NF_{DSB}$  for different values of LO power while Figure 7 shows the matching network employed on the circuit.

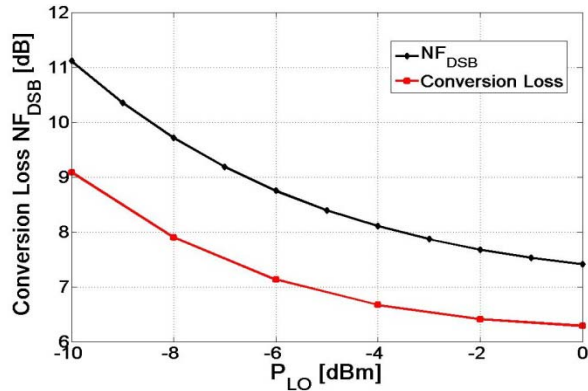

Figure. 6: DSB Noise Figure in function of the Power level of the local oscillator ( $P_{LO}$ )

#### IV. LO BUFFER

To realize a differential buffer stage for the LO signal, a Cascode configuration is chosen to guarantee good isolation, high gain, good stability and low power consumption. However, in the high frequency band the capacitance of the transistor becomes more dominant, so more caution is required when designing the transistor device. In this case a tradeoff is done to achieve 10 dB of Gain, and a -1dB compression point at 0dBm. The power dissipation for the differential buffer is 15 mW

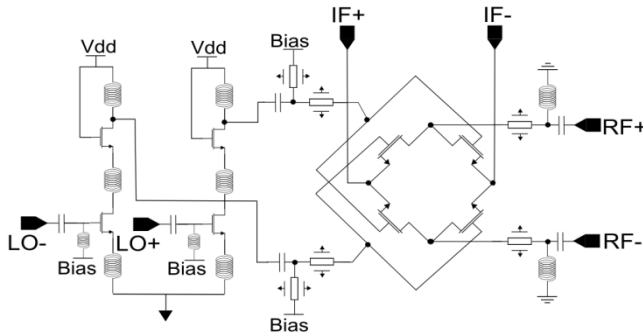

Figure 7: Schematic of the Mixer and LO Buffer with the matching network

#### V. CONCLUSION

A new wide-band dual balanced resistive mixer in silicon CMOS 65nm technology is presented here realized for the 60GHz unlicensed band. This mixer works with a very low LO drive of -5dBm. An equivalent circuit for the parasitic phenomena of the MOS switch is proposed to underline the strong effect of the MOS capacitance. The performed simulations of the mixer circuit show an excellent behavior. The circuit was sent to fabrication Nov

2009, using the CMP facilities (<http://cmp.imag.fr/>). Similar performance is expected for the fabricated mixer because all parasitics are modeled and accurate models are used for active and passive devices at 60GHz [13].

#### REFERENCES

- [1] Gilmore R., Besser L. "Practical RF Circuit Design For Modern Wireless Systems Vol 2 - Active Circuits And Systems", Artech House, 2003
- [2] Komoni, K. and Sonkusale, S. "Modeling, simulation and implementation of a passive mixer in 130nm CMOS technology and scaling issues future technologies" MWSCAS 2008. 51st Midwest Symposium on 10-13 Aug. 2008 Page(s):410 - 413
- [3] Yuhua Cheng, "MOSFET modeling for RF IC design." IEEE Transactions on Electron Devices. vol. 52, pp. 1286 – 1303, July 2005
- [4] Komoni, K. and Sonkusale, S. and Dawe, G., "Fundamental Performance Limits and Scaling of a CMOS Passive Double-Balanced Mixer", Circuits and Systems and TAISA Conference, 2008. Joint 6th International IEEE Northeast Workshop on 22-25 June 2008
- [5] Chang, T. and Lin, J. "1-11 GHz Ultra-Wideband Resistive Ring Mixer in 0.18 um CMOS Technology", (RFIC) Symposium, 2006 IEEE 11-13 June 2006 Page(s):4 pp.
- [6] Circa, R. and Pienkowski, D. and Jahn, S. and Boeck, G. and Muller, M., "Resistive MOSFET Mixer for Mobile Direct Conversion Receiver ", Proceedings of the 2003 SBMO/IEEE MTT-S International Volume 3, Sept. 2003
- [7] Circa, R. and Pienkowski, D. and Boeck, G., "Integrated 130 nm CMOS Passive Mixer for 5 GHz WLAN Applications", Microwave and Optoelectronics, 2005 SBMO/IEEE MTT-S International Conference on 25-28 July 2005 Page(s):103
- [8] Issakov, V. and Thiede, A. and Verweyen, L. and Maurer, L. "Wideband Resistive Ring Mixer for Automotive and Industrial Applications in 0.13 um CMOS", German Microwave Conference, 2009 16-18 March 2009
- [9] Ellinger, F., "26.5-30-GHz Resistive Mixer in 90-nm VLSI SOI CMOS Technology With High Linearity for WLAN", Microwave Theory and Techniques, IEEE Transactions on Volume 53, Issue 8, Aug. 2005 Page(s):2559 - 2565
- [10] Gould, P. and Zelle, C. and Lin, J., "A CMOS resistive ring mixer MMICs for GSM 900 and DCS 1800 base station applications", Microwave Symposium Digest., 2000 IEEE MTT-S International Volume 1, 11-16 June 2000 Page(s):521 - 524 vol.1
- [11] Chenyan Song and Lo, I. and Boric-Lubecke, O. "2.4 GHz 0.18um CMOS Passive Mixer with Integrated Baluns", Microwave Symposium Digest, 2009. MTT '09. IEEE MTT-S International 7-12 June 2009 Page(s):409 - 412
- [12] Lo, I. and Xiaoyue Wang and Boric-Lubecke, O. and Yunpyo Hong and Chenyan Song, "Wide-band 0.25um CMOS passive mixer," Radio and Wireless Symposium, 2009. RWS '09. IEEE 18-22 Jan. 2009 Page(s):502 – 505
- [13] M. Kraemer, D. Dragomirescu, R. Plana, "Accurate Electromagnetic Simulation and Measurement of Millimeter-wave Inductors in Bulk CMOS Technology" SiRF 2010 Paper accepted.