



HAL
open science

Tolerance Synthesis of Mechanisms: a Robust Design Approach

Stéphane Caro, Fouad Bennis, Philippe Wenger

► **To cite this version:**

Stéphane Caro, Fouad Bennis, Philippe Wenger. Tolerance Synthesis of Mechanisms: a Robust Design Approach. *Journal of Mechanical Design*, 2005, 127, pp.86-94. 10.1115/1.1825047 . hal-00463707

HAL Id: hal-00463707

<https://hal.science/hal-00463707>

Submitted on 14 Mar 2010

HAL is a multi-disciplinary open access archive for the deposit and dissemination of scientific research documents, whether they are published or not. The documents may come from teaching and research institutions in France or abroad, or from public or private research centers.

L'archive ouverte pluridisciplinaire **HAL**, est destinée au dépôt et à la diffusion de documents scientifiques de niveau recherche, publiés ou non, émanant des établissements d'enseignement et de recherche français ou étrangers, des laboratoires publics ou privés.

TOLERANCE SYNTHESIS OF MECHANISMS: A ROBUST DESIGN APPROACH

Stéphane Caro, Fouad Bennis, Philippe Wenger

Institut de Recherche en Communications et Cybernétique de Nantes *

1, rue de la Noë, 44321 Nantes, France

Stephane.Caro@irccyn.ec-nantes.fr

Fouad.Bennis@irccyn.ec-nantes.fr

Philippe.Wenger@irccyn.ec-nantes.fr

ABSTRACT

This paper provides a new robust design method to dimension a mechanism and to synthesize its dimensional tolerances. The general issue is to find a robust mechanism for a given task, and to compute its optimal dimensional tolerances. For that purpose, the developed approach follows two consecutive steps, which are independent and complementary. First, the dimensions of the mechanism are computed by means of an appropriate robustness index, which is used to minimize the sensitivity of its performances to variations. These robust dimensions are obtained independently of the amount of variations, and tolerate globally the largest variations. Thus, knowing the acceptable performance error of the mechanism, the second step aims at computing the optimal dimensional tolerances of the mechanism by means of the new tolerance synthesis method. This method is used to find the best distribution of the error between the dimensions of the mechanism. Two serial manipulators are studied to illustrate the theory.

Keywords: robust design, tolerance synthesis, mechanism, variations, sensitivity ellipsoid, optimization.

1 Introduction

Every engineering design is subject to variations that can arise from a variety of sources, including manufacturing operations, variations in material properties, and the operating environment. When variations are ignored, nonrobust designs can result, which are expensive to produce or fail in service. Besides, the robustness of a mechanism is important when calibration is necessary because the lower the sensitivity of the mechanism to dimensional variations, the easier its calibration [1].

The concept of robust design may be first used by Taguchi. He introduced the concept of parameter design to improve the quality of a product whose manufacturing process involves significant variability or noise [2]. Robust design aims at minimizing the sensitivity of performances to variations without controlling the causes of these variations. In the last decades, several authors have contributed to the formulation and the improvement of robust design problems. Kalsi et al. [3] introduced a technique to reduce the effects of uncertainty and incorporate flexibility in the design of complex engineering systems involving multiple decision-makers. Chen et al. [4] studied two broad categories of problems namely, (i) Type 1: minimizing variations in performance caused by variations in noise factors (uncontrollable parameters) and (ii) Type 2: minimizing variations in performance caused by variations in control factors (design variables, *DV*). Sundaresan et al. [5] developed a procedure incorporating uncertainties in *DV* and variations in constraints due to these uncertainties.

The dimensional tolerances of a mechanism are fixed according to various parameters such as the manufacturing process, the performance tolerances, the manufacturing cost. Chase et al. [6, 7] presented the Direct Linearization Method for tolerance analysis of 2-D and 3-D mechanical assemblies. Parkinson [8] used a deterministic method of robust design to determine the optimum nominal dimensions of an assembly in order to improve the assembly quality without tightening tolerances. Moreover, Rajagopalan and Cutkosky [9] used similar methods to analyse the performance errors of mechanisms fabricated *in-Situ*.

Some optimization methods for tolerance synthesis exist in the literature. Zhang and Wang [10] used a simulated annealing algorithm to maximize the robustness of product by appropriately allocating assembly and machining tolerances. Lee et al. [11] presented a tolerance synthesis method for nonlinear sys-

*IRCCyN: UMR n° 6597 CNRS, École Centrale de Nantes, Université de Nantes, École des Mines de Nantes

tems based on nonlinear programming, whereas Gadallah and El-Maraghy [12] presented a method using a system of experimental design. Zhu and Ting [13] used the theory of performance sensitivity distribution to study the sensitivity of the system to variations, and selected one manipulator among six, by means of a robustness index. They defined the tolerance box as a contraction of the circumscribe box of the design sensitivity ellipsoid of the mechanism. The link between dimensional tolerances and product's cost is presented in several works [14].

The paper focuses on mechanisms, which are assemblies of moving parts performing a complete functional motion.

Here, the study of a mechanism and the calculation of its dimensional tolerances are conducted in two consecutive steps. First, its dimensions are computed by means of a robustness index, which is proposed to minimize the sensitivity of its performances to variations. For example, a robust dimensioning of the 2R manipulator, whose end effector E has to hit point P with the highest precision, is depicted in Fig.1. For this dimensioning, the links of the manipulator are perpendicular when E is supposed to hit P . In this configuration, the maximum positioning error of E , ϵ , due to dimensional variations, is a minimum.

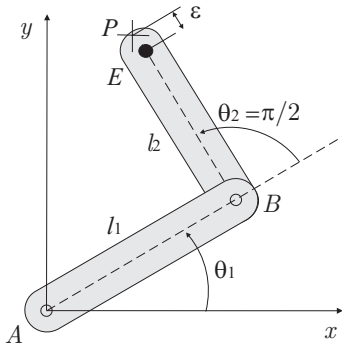

Figure 1. A Robust Dimensioning of the 2R Manipulator

Then, knowing the acceptable performance error of the mechanism, the second step aims at computing the optimal dimensional tolerances of the mechanism by means of a new tolerance synthesis method. This method is based on the robustness approach of the first step.

The formulation of a robust design problem is given in section 2. Section 3 discusses of an appropriate robustness index for mechanisms. The new tolerance synthesis method is developed in section 4. Finally, a 2R manipulator and a 3R manipulator are studied in section 5 to illustrate the theory.

2 Robust design problem

In a robust design problem, the distinction is made between three sets: (i) the set of design variables (DV) whose nominal values can be selected between the range of upper and lower bounds, they are controllable; (ii) the set of design parameters (DP) that cannot be adjusted by the designer, they are uncontrollable; (iii) the set of performance functions. The l -dimensional vector of design variables is denoted by $\mathbf{x} = [x_1 \ x_2 \ \dots \ x_l]^T$. The m -dimensional vector of design parameters is denoted by $\mathbf{p} = [p_1 \ p_2 \ \dots \ p_m]^T$. Performance functions are grouped into the n -dimensional vector $\mathbf{f} = [f_1 \ f_2 \ \dots \ f_n]^T$, [15]. DV are, however, subject to uncontrollable variations because of manufacturing errors, wear, or other uncertainties, although their nominal value is fixed.

For instance, for the slider-crank mechanism depicted by Fig.2, $\mathbf{f} = \langle N \rangle$, $\mathbf{x} = [l_c \ l_r \ e]^T$, and $\mathbf{p} = [f_p \ \mu]$ where $\langle N \rangle$ is the average side force on piston to be minimized. l_c and l_r are the lengths of the rod and the crank of the mechanism. e is the eccentricity between the crank and the piston. f_p is the force on piston and μ is the friction coefficient between the piston and the cylinder.

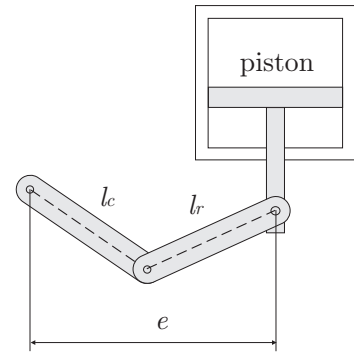

Figure 2. Slider-Crank Mechanism

A system is robust when its performance is as little sensitive as possible to variations. Performance function \mathbf{f} depends on DV and DP , which are supposed to be independent.

$$\mathbf{f} = \mathbf{f}(\mathbf{x}, \mathbf{p}) \quad (1)$$

Here, the study of the sensitivity of the system to variations is based on the theory of performance sensitivity distribution.

$$\delta \mathbf{f} = [\mathbf{J}_x \ \mathbf{J}_p] [\delta \mathbf{x}^T \ \delta \mathbf{p}^T]^T = \mathbf{J} \delta \mathbf{X} \quad (2)$$

In this theory, a Jacobian matrix \mathbf{J} describes the effect of the component variations to the system performance, as depicted by eq.(2) where $\mathbf{J}_x = \partial \mathbf{f} / \partial \mathbf{x}$, $\mathbf{J}_p = \partial \mathbf{f} / \partial \mathbf{p}$, $\mathbf{J} = [\mathbf{J}_x \ \mathbf{J}_p]$, $\mathbf{X}^T = [\mathbf{x}^T \ \mathbf{p}^T]$. $\delta \mathbf{x}$ and $\delta \mathbf{p}$ are the variations in DV and in DP , respectively. \mathbf{J}_x and \mathbf{J}_p are the $(n \times l)$ sensitivity Jacobian matrix of \mathbf{f} with respect to \mathbf{x} and the $(n \times m)$ sensitivity Jacobian matrix of \mathbf{f} with respect to \mathbf{p} , respectively. If variations in DV are not taken into account, then $\mathbf{J} = \mathbf{J}_p$ and $\mathbf{X} = \mathbf{p}$. On the contrary, $\mathbf{J} = \mathbf{J}_x$ and $\mathbf{X} = \mathbf{x}$ when only variations in DV are considered.

The performance distribution is characterized in the variation space by a set of eigenvalues and eigenvectors, *i.e.*: by a hyper-ellipsoid. Without loss of generality, assuming that variations in DV are negligible and that there are only two DP , this design sensitivity hyper-ellipsoid is an ellipse depicted in Fig.3. σ_1 and σ_2 are the smallest and the largest singular values of \mathbf{J} , respectively, and \mathbf{q}_1 , \mathbf{q}_2 are their corresponding eigenvectors. Lengths of semi-axes are inversely proportional to singular values of \mathbf{J} . Points on the ellipse surface lead to the same norm of performance variation, $\|\delta \mathbf{f}\|_2$, where $\|\cdot\|_2$ depicts the Euclidean norm. Moreover, the performance is the least sensitive to variations in the direction of \mathbf{q}_1 and the most sensitive to variations in the direction of \mathbf{q}_2 .

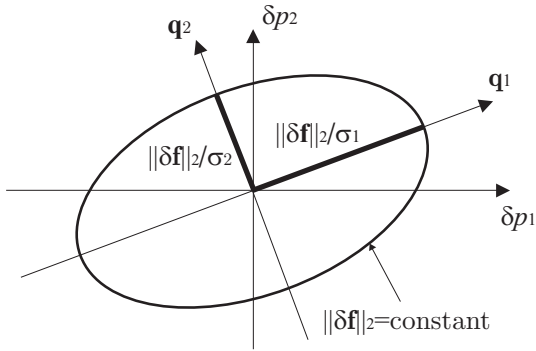

Figure 3. Design Sensitivity Ellipsoid

A mechanism is robust when the sensitivity S of its performances to variations is a minimum. Therefore, S can be defined as the ratio of the Euclidean norm of variations in its performances, $\|\delta \mathbf{f}\|_2$, and the Euclidean norm of variations in DV and DP , $\|\delta \mathbf{X}\|_2$, [15]. S represents a variation transmission ratio and means the amount of variations transmitted from the sources to the design. Besides, eq.(3) follows from eq.(2) and means that S is bounded by the smallest singular value, σ_{min} , and the largest singular value, σ_{max} , of sensitivity Jacobian matrix \mathbf{J} .

$$\sigma_{min} \leq S = \frac{\|\delta \mathbf{f}\|_2}{\|\delta \mathbf{X}\|_2} \leq \sigma_{max} \quad (3)$$

3 Choice of an appropriate robustness index

In order to obtain a robust solution independently of the amount of variations in DV and DP , a judicious robustness index is required. The robustness indices usually found in the recent literature are the condition number and the Euclidean norm of the sensitivity Jacobian matrix, \mathbf{J} . Al-Widyan and Angeles [15], Ting and Long [16] used the condition number of \mathbf{J} . Zhu [13] and Hu et al. [17] suggested the use of the Euclidean norm of \mathbf{J} . In this section, it is shown that the Euclidean norm of \mathbf{J} is more appropriate for the robust design of mechanisms.

The condition number of a matrix is the ratio of its largest singular value to its smallest singular value. Let RI_1 be the condition number of \mathbf{J} .

$$RI_1 = \|\mathbf{J}\|_2 \|\mathbf{J}^{-1}\|_2 = \frac{\sigma_{max}}{\sigma_{min}} \quad (4)$$

According to [16, 15], a design is robust when RI_1 is a minimum. Assuming that only variations in DP are considered, each variation δp_i has the same influence on the norm of variations in performance when RI_1 is unitary, *i.e.*: the sensitivity ellipsoid is a sphere. Although this property is interesting, the previous index is not sufficient because the influence of δp_i on performance is not necessarily a minimum when RI_1 is unitary, [18]. Indeed, the condition number, RI_1 , can be small even if the values of σ_{min} and σ_{max} are large.

A singular value of \mathbf{J} corresponds to the error transmission factor in the direction of its corresponding eigenvector and in the space of variations. The ideal solution is the minimization of all the singular values of \mathbf{J} , but is not easy to obtain. According to eq.(3), a compromise solution is to minimize the upper bound of S , which is the largest singular value of \mathbf{J} . Thus, a second robustness index, RI_2 , is defined by eq.(5).

$$RI_2 = \|\mathbf{J}\|_2 = \sigma_{max} \quad (5)$$

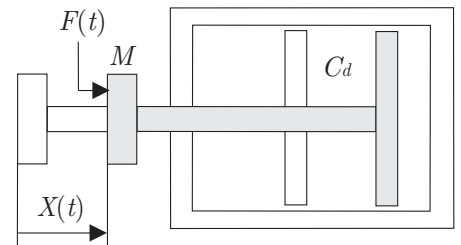

Figure 4. Damper

The damper shown in Fig.4 is studied to compare RI_1 and RI_2 . The design variables are mass M and damping coefficient C_d to be determined with the aim of keeping the magnitude of displacement X_0 at a nominal value of 0.1m, while the magnitude F_0 of the excitation force $F(t) = F_0 \cos(\omega t)$ and its pulsation ω undergo considerable variations beyond the control of the designer: $F_0 = 10\text{N}$, $\omega = 2\pi \text{ rad/s}$. The displacement is equal to $X(t) = X_0 \cos(\omega t + \phi)$ where ϕ is the phase. Moreover, the following relations exist:

$$X_0 = \frac{F_0}{\omega \sqrt{C_d^2 + \omega^2 M^2}}, \quad \phi = \tan^{-1} \left(\frac{\omega M}{C_d} \right)$$

$\mathbf{x} = [M \ C_d]^T$, $\mathbf{p} = [F_0 \ \omega]^T$, $\mathbf{f} = [X_0 \ \phi]^T$. Equation (6) gives the relation between variations in \mathbf{f} and variations in \mathbf{p} .

$$\delta \mathbf{f} = \mathbf{J} \delta \mathbf{p} \quad (6)$$

where the sensitivity Jacobian matrix depends on \mathbf{x} and \mathbf{p} , and is equal to:

$$\mathbf{J} = \mathbf{J}_p = \begin{bmatrix} 1 & -1 - \alpha^2 \\ 0 & \alpha \sqrt{1 - \alpha^2} \end{bmatrix}, \quad \alpha = \frac{X_0}{F_0} \omega^2 M$$

and

$$\delta \mathbf{f} = \begin{bmatrix} \delta X_0 / X_0 \\ \delta \phi \end{bmatrix}, \quad \delta \mathbf{p} = \begin{bmatrix} \delta F_0 / F_0 \\ \delta \omega / \omega \end{bmatrix}$$

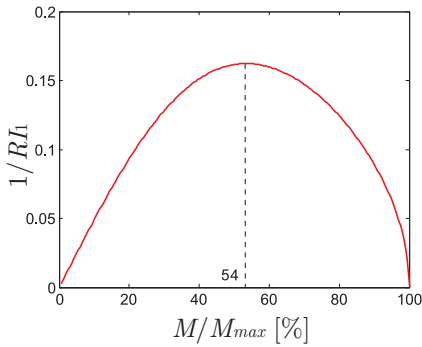

Figure 5. Robustness index RI_1

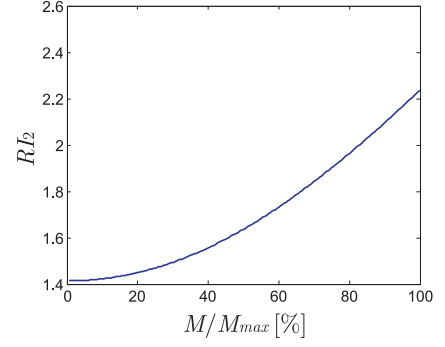

Figure 6. Robustness index RI_2

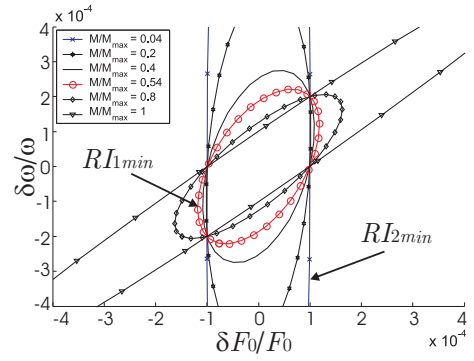

Figure 7. Design Sensitivity Ellipses

Figures 5, 6 depict robustness indices RI_1 and RI_2 of the damper with respect to M , respectively. In Fig.5, RI_1 is a minimum when $M/M_{max} = 0.54$ with $M_{max} = 2.533\text{kg}$. Fig.6 shows that RI_2 increases with M . According to Fig.7, which depicts some design sensitivity ellipses of the damper, plotted for different values of M , the more M tends towards zero, the larger the size of the ellipse. It means that the design can tolerate globally more variations in F_0 and ω , *i.e.*: it is robust. Besides, the ellipse corresponding to the value of M/M_{max} that minimises RI_1 is the smallest one. Therefore, minimizing RI_1 is not equivalent to minimizing the influence of variations in DP on performance function.

Chen et al. [4] and Parkinson [19] proposed an optimization algorithm to increase the robustness of a design without using robustness indices. However, they need to know the magnitude of source variations to use their algorithm. Assuming that $\Delta F_0 / F_0 = 0.1$, $\Delta \omega / \omega = 0.1$ and $M / M_{max} \geq 1/2$, their algorithm converges on $M / M_{max} = 1/2$ and $C_d = 13.78 \text{ N.s.m}^{-1}$ in order to minimize variations in X_0 and ϕ . So, according to [4] and [19], the mass of the damper is minimized to make it robust, like with robustness index RI_2 . In conclusion, the study of the damper confirms that RI_2 is more suitable than RI_1 to evaluate the robustness

of a mechanism. RI_2 is used in the following sections of this paper.

Remark: It is important not to confuse symbols δ and Δ . δv depicts the variation of variable v and Δv depicts its tolerance, i.e.: $-\Delta v \leq \delta v \leq \Delta v$.

4 An efficient tolerance synthesis method

The dimensional tolerances of a mechanism are usually fixed according to various parameters such as the manufacturing process, the performance tolerances, the manufacturing cost. Some optimization methods for tolerance synthesis exist in the literature. Zhu and Ting [13] defined the tolerance box as a contraction of the circumscribe box of the design sensitivity ellipsoid of the mechanism. However, this Tolerance Box, called Zhu-TB, includes some rejects, cf Fig.8.

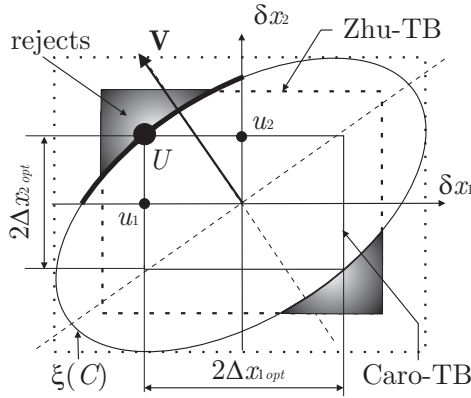

Figure 8. Tolerance Synthesis, $l=2$

Some works in the literature deal with the link between dimensional tolerances and product's cost [14, 9]. Here, the cost of a mechanism is supposed to decrease when its dimensional tolerances increase. Thus, a new tolerance synthesis method is proposed, which aims at finding the largest tolerance box of a mechanism that does not include rejects. Let $\xi(C)$ be the design sensitivity ellipsoid of a mechanism corresponding to a norm of variations in its performance equal to C . Assuming that this norm has to be smaller than C , the optimal tolerance box is supposed to be the largest box included in $\xi(C)$. This tolerance box called Caro-TB and depicted in Fig.8, is smaller than Zhu-TB, but does not include any reject. The choice of the tolerance box depends on the wish of the designer. However, it is always important to know the solution without rejects because the cost of the loss due to rejects can be estimated from this solution.

First, nominal values $\bar{\mathbf{x}} = [\bar{x}_1 \bar{x}_2 \cdots \bar{x}_l]^T$ of design variables are computed from robustness index RI_2 , presented in section 3.

Then, their optimal dimensional tolerances $\Delta x_{i,opt}$ are computed using the following optimization algorithm:

$$\begin{cases} \max_{\mathbf{u}} \prod_{i=1}^l |u_i| \\ s.t. \quad U(u_1, u_2, \dots, u_l) \in \xi(C) \\ \quad \quad u_i \cdot \text{sign}(V_i) \geq 0, \quad i = 1, \dots, l \\ \quad \quad |u_i| \geq \Delta x_{i,min}, \quad i = 1, \dots, l \end{cases}$$

$$\Delta x_{i,opt} = |u_i|, \quad \bar{x}_i - \Delta x_{i,opt} \leq x_i \leq \bar{x}_i + \Delta x_{i,opt}, \quad i = 1, \dots, l$$

This algorithm consists in maximizing the *hyper-volume* of the tolerance box included in $\xi(C)$. \mathbf{V} is the eigenvector corresponding to the maximum singular value of the sensitivity Jacobian matrix of the mechanism and V_i is its i^{th} component. Besides, point U whose coordinates are (u_1, u_2, \dots, u_l) belongs to $\xi(C)$ if and only if $\mathbf{u}^T \mathbf{J}_x^T \mathbf{J}_x \mathbf{u} = C^2$ where $\mathbf{u} = [u_1, u_2, \dots, u_l]^T$. Moreover, each dimensional tolerance Δx_i has to be higher than a minimum dimensional tolerance $\Delta x_{i,min}$, depending on the manufacturing process and \bar{x}_i . For instance, Fig.8 depicts all the possible positions of U when $l = 2$ and V_1, V_2 are negative and positive, respectively.

In the following, a 2R and a 3R manipulators are studied to illustrate the proposed robust design and tolerance synthesis methods. If the positioning error of the end effector has to be smaller than a scalar C at n different goal poses, it means that the tolerance box has to be included in n design sensitivity ellipsoids because each pose of the manipulator is associated with a design sensitivity ellipsoid. However, the tolerance synthesis algorithm works with only one design sensitivity ellipsoid. To cope with this problem, we consider the most restrictive ellipsoid, ξ_{mr} . As for any serial manipulator, a unitary variation in one design variable and no variation in the others lead to a unitary positioning error of its end effector, the design sensitivity ellipsoids intersect at 2^l points where l is the number of design variables. Therefore, ξ_{mr} is the ellipsoid with the smallest small axis among the n design sensitivity ellipsoids.

5 Case studies

5.1 Study of a 2R manipulator

The mechanism studied in this section is a serial 2R manipulator, depicted in Fig.9. It is composed of two revolute joints and two links AB and BE of lengths l_1 and l_2 , respectively. First, the manipulator is designed, so that its end-effector E can hit all points of a target S_T , and to be as little sensitive as possible to dimensional variations. Indeed, the lower the sensitivity of the manipulator to dimensional variations, the easier its calibration [1]. Subsequently, the tolerance synthesis method introduced in section 4 is used to compute its optimal dimensional tolerances.

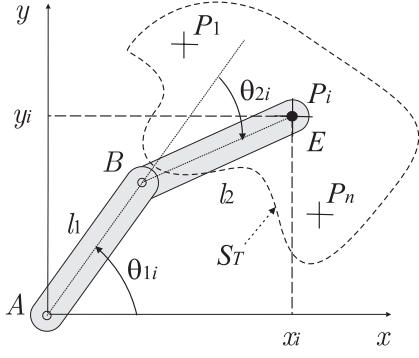

Figure 9. A 2R Manipulator and its target S_T

5.1.1 Dimensioning of the 2R manipulator Let S_T be defined as a set of n points P_1, P_2, \dots, P_n . First, E can hit all points in S_T if and only if l_1 and l_2 satisfy the following conditions:

$$\begin{cases} |l_1 - l_2| \leq r \\ l_1 + l_2 \geq R \end{cases}$$

with $r = \min_i d(A, P_i)$, $R = \max_i d(A, P_i)$, $i = 1, \dots, n$ where $d(A, P_i)$ is the distance between P_i and A . These conditions bound the feasible design variables space as shown in Fig.10.

The formulation of a robust design problem was given in section 2. For the manipulator under study, the set of design variables, \mathbf{x} , and the set of performance functions, \mathbf{f} , are given by eqs.(7,8).

$$\mathbf{x} = [l_1 \ l_2]^T, \quad \mathbf{f} = [\mathbf{e}_1^T \ \dots \ \mathbf{e}_i^T \ \dots \ \mathbf{e}_n^T]^T \quad (7)$$

$$\mathbf{e}_i = l_1 [C_{\theta_{1i}} \ S_{\theta_{1i}}]^T + l_2 [C_{\theta_{1i}+\theta_{2i}} \ S_{\theta_{1i}+\theta_{2i}}]^T \quad (8)$$

where \mathbf{e}_i is the vector of the Cartesian coordinates of E at P_i . $C_{\theta_{ji}} = \cos \theta_{ji}$, $S_{\theta_{ji}} = \sin \theta_{ji}$ where θ_{ji} is the j^{th} actuated joint variable at P_i , $j = 1, 2$.

The relation between the positioning error of E at P_i , $\delta \mathbf{f}_i$, and dimensional variations δl_1 , and δl_2 , follows from eq.(8) and is given by eq.(9).

$$\delta \mathbf{f}_i = \mathbf{J}_{x_i} \delta \mathbf{x} \quad \text{with} \quad \mathbf{J}_{x_i} = \begin{bmatrix} C_{\theta_{1i}} & C_{\theta_{1i}+\theta_{2i}} \\ S_{\theta_{1i}} & S_{\theta_{1i}+\theta_{2i}} \end{bmatrix}; \quad \delta \mathbf{x} = \begin{bmatrix} \delta l_1 \\ \delta l_2 \end{bmatrix} \quad (9)$$

The norm of $\delta \mathbf{f} = [\delta \mathbf{f}_1^T, \dots, \delta \mathbf{f}_i^T, \dots, \delta \mathbf{f}_n^T]^T$, $\|\delta \mathbf{f}\|$, is the global positioning error of E on S_T . The sensitivity Jacobian matrix of the manipulator, \mathbf{J}_x , is a $(2n \times 2)$ matrix composed of matrices

\mathbf{J}_{x_i} . The relation between $\delta \mathbf{f}$, \mathbf{J}_x and dimensional variations, $\delta \mathbf{x}$, is given by eq.(10).

$$\delta \mathbf{f} = \mathbf{J}_x \delta \mathbf{x} \quad \text{with} \quad \mathbf{J}_x = [\mathbf{J}_{x_1}^T \ \dots \ \mathbf{J}_{x_i}^T \ \dots \ \mathbf{J}_{x_n}^T]^T \quad (10)$$

The robustness of the manipulator with respect to dimensional variations is quantified by robustness index RI_2 , defined in section 3. RI_2 is the maximum singular value of \mathbf{J}_x and corresponds to the maximum norm of positioning error of E , $\|\delta \mathbf{f}\|_{max}$, when the norm of dimensional variations is unitary, i.e.: $\delta l_1^2 + \delta l_2^2 = 1$.

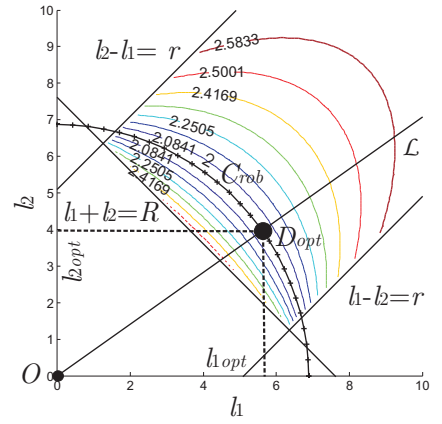

Figure 10. $RI_2 = f(l_1, l_2)$

Let S_T be made up of four points, P_1, P_2, P_3, P_4 , whose Cartesian coordinates are (1,5), (2,7), (3,7), (4,6), respectively. Fig.10 shows the isocontours of RI_2 in the feasible design variable space. We can notice that RI_2 isocontours form a family of ellipses and that RI_2 is a minimum when design variables belong to the circle C_{rob} . In fact, the algebraic expression of RI_2 can be derived as shown in eq.(11):

$$RI_2 = \sqrt{n + \left| \sum_{i=1}^n \cos \theta_{2i} \right|} = \sqrt{n + \left| \sum_{i=1}^n \frac{x_i^2 + y_i^2 - l_1^2 - l_2^2}{2l_1 l_2} \right|} \quad (11)$$

where x_i and y_i are the Cartesian coordinates of point P_i . Thus, the set of solutions (l_1, l_2) , satisfying eq.(11) for a fixed RI_2 , is either ellipse ϵ_1 or ellipse ϵ_2 whose equations are $L_1^2/a_1^2 + L_2^2/b_1^2 = c$ and $L_1^2/a_2^2 + L_2^2/b_2^2 = c$, respectively, where $a_1 = b_2 = 1/RI_2$, $a_2 = b_1 = 1/\sqrt{2n - RI_2^2}$. L_1 and L_2 are the expressions of l_1 and l_2 in the coordinate frame rotated of 45 deg with respect to the

reference frame of the design variable space. Thus, ε_1 and ε_2 , depicted in Fig.11, are the isocontours of robustness index RI_2 .

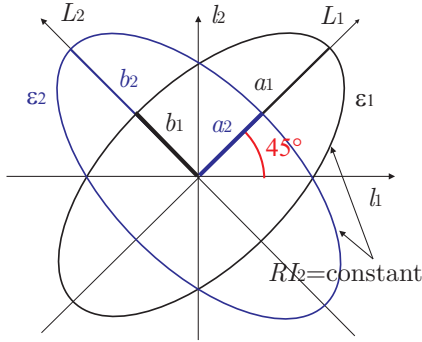

Figure 11. Design Variables (l_1, l_2) corresponding to the same RI_2

$$l_1^2 + l_2^2 = \frac{1}{n} \sum_{i=1}^n x_i^2 + y_i^2 = \frac{1}{n} \sum_{i=1}^n d^2(A, P_i) \quad (12)$$

According to eq.(11), RI_2 is a minimum when eq.(12) is satisfied, *i.e.*: when dimensioning (l_1, l_2) belongs to the circle of radius the square root of the mean of square distances between points A and P_i and centered at the origin of the design space variable. Therefore, this circle corresponds to C_{rob} . Its radius is equal to 6.87. Thus, there exists an infinite number of dimensionings (l_1, l_2) that minimize RI_2 . Three of them are depicted in Fig.12.

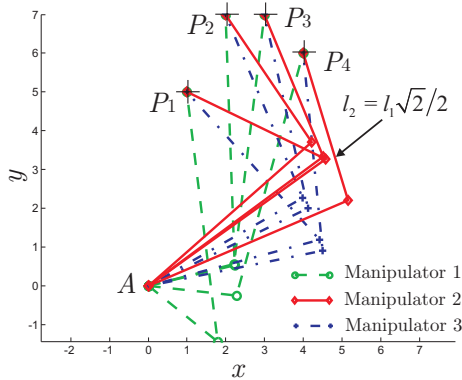

Figure 12. Robust Manipulators

According to eq.(11), the maximum global positioning error of E is a minimum when cosines of angles θ_{2i} tend towards

zero. It means that the links of a robust $2R$ manipulator should be almost perpendicular. That is apparent in Fig.12. The obtained robust dimensions are independent of the amount of variations and tolerate globally the largest variations.

As there are several robust manipulators, the designer can choose another criterion to be optimized. For instance, he can take into account the cost or the complexity of the mechanism. Here, the optimal robust manipulator is supposed to be the one with the best dexterity. This criterion is frequently used in manipulator design. It evaluates the ease of a manipulator to execute motions or arbitrary motions in all directions. It is quantified by the condition number of its kinematic Jacobian matrix, [20]. The smaller this condition number, the higher the dexterity. Besides, the manipulator is isotropic when its condition number is equal to one, [20]. Let \mathbf{J}_k be the kinematic Jacobian matrix of the $2R$ manipulator:

$$\mathbf{J}_k = \begin{bmatrix} -l_1 \sin(\theta_1) - l_2 \sin(\theta_1 + \theta_2) & -l_2 \sin(\theta_1 + \theta_2) \\ l_1 \cos(\theta_1) + l_2 \cos(\theta_1 + \theta_2) & l_2 \cos(\theta_1 + \theta_2) \end{bmatrix} \quad (13)$$

For any posture of the manipulator defined by angle θ_2 , the condition number of \mathbf{J}_k is a minimum if and only if $l_2 = l_1 \sqrt{2}/2$ [20]. Let \mathcal{L} be the line of equation $l_2 = l_1 \sqrt{2}/2$. D_{opt} , the intersection of C_{rob} with \mathcal{L} , depicts the optimal robust manipulator, cf Fig.10. In conclusion, the $2R$ manipulator of link lengths $l_1 = l_{1opt} = 5.61$ and $l_2 = l_{2opt} = 3.97$ is the optimal robust one, *i.e.*: the one with the best dexterity among the least sensitive ones to dimensional variations that allow their end effector E to hit all points in S_T . This manipulator is the second one depicted in Fig.12, *i.e.*: the one whose links are depicted with bold lines.

In conclusion, the robust design method gave the set of all the robust manipulators. The optimal dimensioning was chosen among this set by means of another criterion, namely the dexterity. In the following section, the tolerance synthesis method presented in section 4 is used to compute the optimal dimensional tolerances of the selected manipulator.

5.1.2 Tolerance synthesis of the $2R$ manipulator

In addition to the fact that E has to hit every point of S_T , its positioning error has to be smaller than $10 \mu\text{m}$ whatever its pose.

Fig.13 depicts the design sensitivity ellipses of the optimal robust manipulator defined in the previous section, when target S_T is defined by P_1, P_2, P_3, P_4 , plotted in Fig.12. The shape, size and orientation of these ellipses depend only on the second actuated joint variable, θ_2 , of the manipulator. θ_2 belongs to interval $[\theta_{2min}, \theta_{2max}]$ to allow E to hit all points of S_T . Moreover, points on these ellipses lead to the same positioning error of E , equal to $10 \mu\text{m}$.

The optimal dimensional tolerances Δl_{1opt} and Δl_{2opt} of lengths l_1 and l_2 are computed from the tolerance synthesis

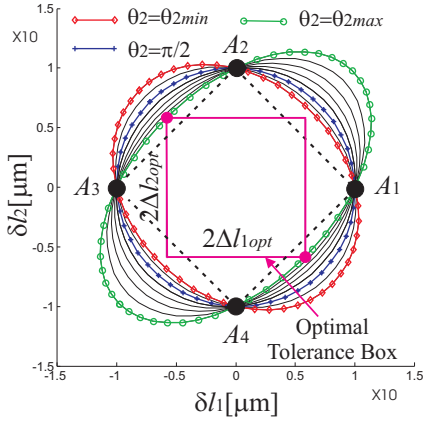

Figure 13. Tolerance Box

method developed in section 4. The ellipse used in the tolerance synthesis algorithm is the one corresponding to θ_{2max} , *i.e.*: the one with the smallest semi-axis. Finally, $\Delta l_{1opt} = \Delta l_{2opt} = 5.82\mu\text{m}$ and the corresponding tolerance box is depicted in Fig.13.

Points $A_1(1, 0)$, $A_2(0, 1)$, $A_3(-1, 0)$, $A_4(0, -1)$ belong to all design sensitivity ellipses of the manipulator because a unitary variation in l_i and no variation in l_j , ($i \neq j$), lead to a unitary positioning error of its end effector. As an ellipse is convex, square $A_1A_2A_3A_4$ is included in all the design sensitivity ellipses whatever the bounds of θ_2 . It follows that eq.(14) is a sufficient condition for the positioning error of E to be smaller than $10\mu\text{m}$ whatever its pose.

$$\Delta l_1 + \Delta l_2 \leq 10\mu\text{m} \quad (14)$$

Without the tolerance synthesis method developed in section 4, the designer would have chosen dimensional tolerances Δl_1 and Δl_2 by means of eq.(14). Here, Δl_{1opt} and Δl_{2opt} do not respect eq.(14) because $\Delta l_{1opt} + \Delta l_{2opt} = 11.64\mu\text{m}$. However, they allow the positioning error of E to be smaller than $10\mu\text{m}$ on S_T . So, knowing the target of the manipulator, the tolerance synthesis method proposed in section 4 is more interesting than the sufficient condition, defined by eq.(14), to synthesize its dimensional tolerances.

The 2R manipulator has been studied in order to get graphical interpretations of the results and algebraic expressions of robustness index RI_2 . However, the foregoing methods can be applied to more general mechanisms and RI_2 may be computed numerically, as for the study of the 3R manipulator in the following section.

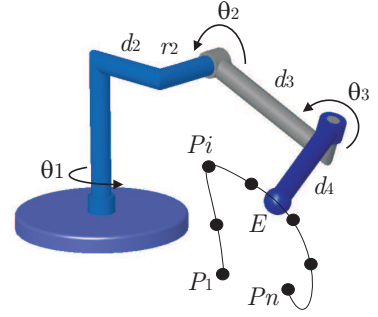

Figure 14. 3R Manipulator

5.2 Tolerance synthesis of a 3R manipulator

A three-dof serial positioning manipulator with three revolute joints is shown in Fig.14. Modified D-H parameters are used to describe its geometry [21]. θ_1 , θ_2 , θ_3 are the actuated joint variables of the 3R manipulator and d_2 , r_2 , d_3 , d_4 denote its dimensions. Its inverse geometric model was studied in [22]. The positioning error, ϵ_E , of end effector E , has to be smaller than $10\mu\text{m}$ at any point P_i , $i = 1, \dots, n$, of a path. Variations in θ_1 , θ_2 and θ_3 are negligible because the encoders are supposed to be very accurate. So, ϵ_E depends on variations in the other D-H parameters. Here, only variations in d_2 , r_2 , d_3 are considered in order to get graphical representation.

The relation between the positioning error of E at P_i , $\delta \mathbf{f}_i$, and dimensional variations δd_2 , δr_2 , and δd_3 , is given by eq.(15).

$$\delta \mathbf{f}_i = \mathbf{J}_{x_i} \delta \mathbf{x} \quad \text{with} \quad \mathbf{J}_{x_i} = \begin{bmatrix} \cos \theta_{1i} & -\sin \theta_{1i} & \cos \theta_{1i} \cos \theta_{2i} \\ \sin \theta_{1i} & \cos \theta_{1i} & \sin \theta_{1i} \cos \theta_{2i} \\ 0 & 0 & -\sin \theta_{2i} \end{bmatrix} \quad (15)$$

where θ_{1i} and θ_{2i} are the values of θ_1 and θ_2 at P_i , computed with the inverse kinematic model of the manipulator [22]. $\mathbf{f} = [e_x \ e_y \ e_z]^T$ where e_x , e_y and e_z denote the Cartesian coordinates of E and $\delta \mathbf{x} = [\delta d_2 \ \delta r_2 \ \delta d_3]^T$ where δd_2 , δr_2 , δd_3 are variations in d_2 , r_2 , d_3 , respectively.

The norm of $\delta \mathbf{f} = [\delta \mathbf{f}_1^T, \dots, \delta \mathbf{f}_i^T, \dots, \delta \mathbf{f}_n^T]^T$, $\|\delta \mathbf{f}\|$, is the global positioning error of E . The sensitivity Jacobian matrix of the manipulator, \mathbf{J}_x , is a $(3n \times 2)$ matrix composed of matrices \mathbf{J}_{x_i} . The relation between $\delta \mathbf{f}$, \mathbf{J}_x , and $\delta \mathbf{x}$, is given by eq.(10).

Assuming that $n = 5$ and Cartesian coordinates of points P_1, P_2, P_3, P_4, P_5 , are $(1, 1, 1)$, $(2, -2, 3)$, $(5, 6, 2)$, $(-1, -4, 3)$, $(2, 3, 5)$, respectively. Index RI_2 , defined in section 3, is used to find the robust dimensioning of the manipulator, and is computed numerically. Here, RI_2 is a minimum and the design of the manipulator is robust when $d_2 = 1.75$, $r_2 = 2.5$, $d_3 = 3.25$, and $d_4 = 2.5$.

Fig.15 depicts the most restrictive ellipsoid of the manipulator and its optimal tolerance box. The most restrictive ellipsoid,

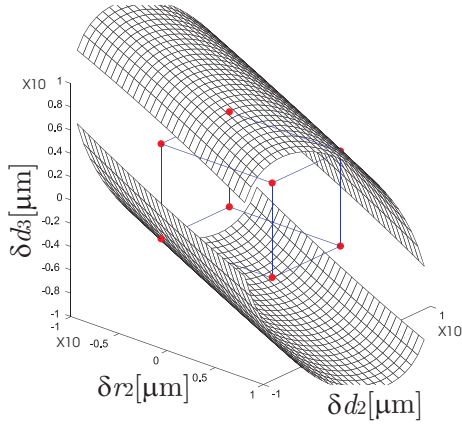

Figure 15. The Most Restrictive Ellipsoid & the Optimal Tolerance Box

ξ_{mr} , is the one with the smallest semi-axis among the five design ellipsoids of the manipulator and corresponds to point P_1 . The tolerance synthesis method proposed in section 4 is used to compute the optimal tolerance box included in the most restrictive ellipsoid, *i.e.*: the following algorithm is used to compute Δd_{2opt} , Δr_{2opt} and Δd_{3opt} :

$$\begin{cases} \max_{\mathbf{u}} |u_1 u_2 u_3| \\ s.t. \quad U(u_1, u_2, u_3) \in \xi_{mr} \\ u_1 \geq 0 \\ u_3 \geq 0 \\ |u_i| \geq \Delta x_{imin}, i = 1, \dots, 3 \end{cases}$$

where $\Delta x_{1min} = 1\mu\text{m}$, $\Delta x_{2min} = \frac{r_2}{d_2} \Delta x_{1min}$, $\Delta x_{3min} = \frac{d_3}{d_2} \Delta x_{1min}$

The results of this optimization problem are: $u_1 = 4.08\mu$, $u_2 = -5.77\mu$ and $u_3 = 4.08\mu$. Thus, $\Delta d_{2opt} = 4.08\mu\text{m}$, $\Delta r_{2opt} = 5.77\mu\text{m}$ and $\Delta d_{3opt} = 4.08\mu\text{m}$.

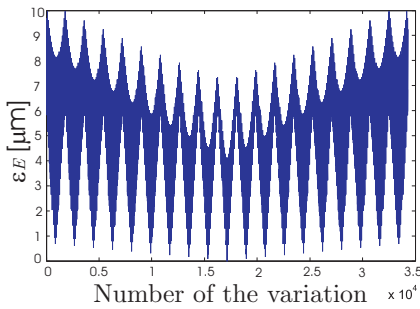

Figure 16. Validation of the Optimal Tolerance Box

Fig.16 depicts the values of ϵ_E when δd_2 , δr_2 , δd_3 , are be-

tween $-\Delta d_{2opt}$ and Δd_{2opt} , $-\Delta r_{2opt}$ and Δr_{2opt} , $-\Delta d_{3opt}$ and Δd_{3opt} , respectively, and for the five poses of the manipulator. ϵ_E is always smaller than $10\mu\text{m}$. It means that the positioning error of E is smaller than $10\mu\text{m}$ for any posture of the manipulator when the tolerances of d_2 , r_2 , and d_3 are Δd_{2opt} , Δr_{2opt} , and Δd_{3opt} , respectively.

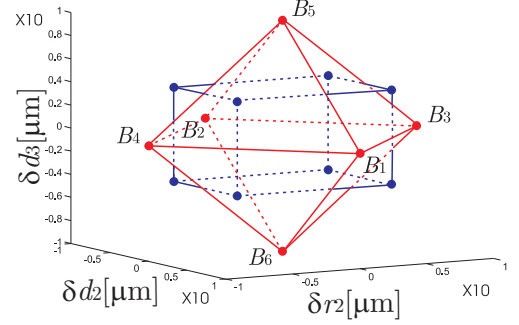

Figure 17. The Optimal Tolerance Box is not included in the Octahedron

Points $B_1(1,0,0)$, $B_2(-1,0,0)$, $B_3(0,1,0)$, $B_4(0,-1,0)$, $B_5(0,0,1)$ and $B_6(0,0,-1)$ belong to all design sensitivity ellipsoids of the manipulator because a unitary variation of a design variable and no variation of the others lead to a unitary variation of the position of E . As an ellipsoid is a convex volume, octahedron $B_1, B_2, B_3, B_4, B_5, B_6$ depicted in Fig.17 is included in all the design sensitivity ellipsoids of the manipulator such that a point on the surface leads to a positioning error of E equal to $10\mu\text{m}$. It follows that eq.(16) is a sufficient condition for the positioning error of E to be smaller than $10\mu\text{m}$ whatever its pose.

$$\Delta d_2 + \Delta r_2 + \Delta d_3 \leq 10\mu\text{m} \quad (16)$$

Without the tolerance synthesis method proposed in section 4, the designer would have chosen dimensional tolerances Δd_2 , Δr_2 , and Δd_3 by means of eq.(16). Here, Δd_{2opt} , Δr_{2opt} , and Δd_{3opt} do not respect eq.(16) because $\Delta d_{2opt} + \Delta r_{2opt} + \Delta d_{3opt} = 13.9\mu\text{m}$. It means that the optimal tolerance box is not included in octahedron $B_1, B_2, B_3, B_4, B_5, B_6$, as depicted by Fig.17. However, they allow the positioning error of E to be smaller than $10\mu\text{m}$ at each pose P_i , $i = 1, \dots, 5$. So, knowing the target of the manipulator, the tolerance synthesis method proposed in section 4 is more interesting than the sufficient condition, defined by eq.(16), to synthesize its dimensional tolerances.

In conclusion, the optimal dimensional tolerances of the 3R manipulator are $\Delta d_2 = 4.08\mu\text{m}$, $\Delta r_2 = 5.77\mu\text{m}$ and $\Delta d_3 = 4.08\mu\text{m}$ so that the positioning error of E is less than $10\mu\text{m}$ at any point P_i , $i = 1, \dots, 5$.

6 Conclusions

This paper has provided a new and efficient tolerance synthesis method for mechanisms, based on a robust design approach. The study of the robustness of a mechanism follows two consecutive steps, which are independent and complementary. The first step aims at computing its robust dimensions by means of an appropriate robustness index. The Euclidean norm of the sensitivity Jacobian matrix is such an index. The study of a damper confirmed that the Euclidean norm of its sensitivity Jacobian matrix is more suitable than its condition number, to quantify the robustness of a mechanism. This method yields the set of all the robust manipulators and allows the designer to integrate other criteria. Then, the developed tolerance synthesis method is used to compute the optimal tolerance box of the selected robust manipulator. The theory is illustrated by two serial manipulators. The application of this theory to the robust design and tolerance synthesis of parallel manipulators is one of the next steps in our research work.

REFERENCES

- [1] Khalil, W., Besnard, S., Lemoine, P., *Comparison study of the geometric parameters calibration methods*, International Journal of Robotics and Automation, Vol.15, 2000, 56-67.
- [2] Taguchi, G., *On robust technology development, Bringing Quality Engineering Upstream*, ASME Press, 1993.
- [3] Kalsi, M., Hacker, K., Lewis, K., *A comprehensive robust design approach for decision trade-offs in complex systems design*, Transactions of the ASME, Journal of Mechanical Design, Vol.121, march, 2001, 1-10.
- [4] Chen, W., Allen, J.K., Tsui, K-L., Mistree, F., *A procedure for robust design: minimizing variations caused by noise factors and control factors*, Transactions of the ASME, Journal of Mechanical Design, Vol.118, december, 1996, 478-485.
- [5] Sundaresan, S., Ishii, K., Houser, D.R., *A robust optimization procedure with variations on design variables and constraints*, DE.Vol 65-1, Advances in Design Automation, ASME 1993, Vol.1, 1993, 379-386.
- [6] Chase, K., Gao, J., Magleby, S.P., Sorensen, C.D., *Including geometric feature variations in tolerance analysis of mechanical assemblies*, IIE transactions, Vol.28, 1996, 795-807.
- [7] Gao, J., Chase, K., Magleby, S.P., *Generalized 3-D tolerance analysis of mechanical assemblies with small kinematic adjustments*, IIE transactions, Vol.30, 1998, 367-377.
- [8] Parkinson, D.B., *The Application of a Robust Design Method to Tolerancing*, Transactions of the ASME, Journal of Mechanical Design, Vol.122, june, 2000, 149-154.
- [9] Rajagopalan, S., Cutkosky, M., *Error analysis for the In-Situ fabrication of mechanisms*, Transactions of the ASME, Journal of Mechanical Design, Vol.125, december, 2003, 809-822.
- [10] Zhang, C., Wang, B., *Robust design of assembly design and machining tolerance allocations*, IIE Transactions 30(1), 1998, 17-29.
- [11] Lee, W.J., Woo, T.C., Chou, S.Y. *Tolerance synthesis for nonlinear systems based on nonlinear programming*, IIE Transactions 25(1), 1993, 51-61.
- [12] Gadallah, M., ElMaraghy, H., *The tolerance optimization problem using a system of experimental design*, In Advances in Design Automation, Vol.69, ASME Publishers, NY, 1994, 251-265.
- [13] Zhu, J., Ting, K.L., *Performance distribution analysis and robust design*, Transactions of the ASME, Journal of Mechanical Design, Vol.123, march, 2001, 11-17.
- [14] Zhang, G., Porchet, M., *Some new developments in tolerance design in CAD*, DE-Vol.66-2, Advances in Design Automation - Vol.2, ASME, 1993.
- [15] Al-widyan, K., Angeles, J., *A model-based framework for robust design*, Recent Advances in Integrated Design and Manufacturing in Mechanical Engineering, Kluwer Academic Publisher, 2003.
- [16] Ting, K.L., Long, Y., *Performance quality and tolerance sensitivity of mechanisms*, Transactions of the ASME, Journal of Mechanical Design, Vol.118, march, 1996, 144-150.
- [17] Hu, S.J., Webbink, R., Lee, J., Long, Y., *Robustness evaluation for compliant assembly systems*, Transactions of the ASME, Journal of Mechanical Design, Vol.125, June, 2003, 262-267.
- [18] Caro, S., Bennis, F., Wenger, P., *Search for an optimal robustness index for the design of mechanisms*, Technical Report, RI 2002-16, IRCCyN, Ecole Centrale de Nantes, July 2002.
- [19] Parkinson, A., *Robust mechanical design using engineering models*, Transactions of the ASME, Journal of Mechanical Design, Vol.117, June, 1995, 48-54.
- [20] Angeles, J., *Fundamentals of Robotic Mechanical Systems*, Springer-Verlag, New-York, ISBN 0-387-94540-7, 1997.
- [21] Khalil, W., Kleinfinger, J.F. *A new geometric notation for open and closed loop robots*, Proc.IEEE Int. Conf. Rob. and Aut., 1986, 1174-1179.
- [22] Wenger, P., *Classification of 3R positioning manipulators*, Transactions of the ASME, Journal of Mechanical Design, Vol.120, june, 1998, 327-332.