



HAL
open science

Performances and Design of Ironless Loudspeaker Motor Structures

Benoit Merit, Guy Lemarquand, Valérie Lemarquand

► **To cite this version:**

Benoit Merit, Guy Lemarquand, Valérie Lemarquand. Performances and Design of Ironless Loudspeaker Motor Structures. *Journal of Applied Acoustics*, 2010, 71 (6), pp.546-555. <10.1016/j.apacoust.2009.12.004>. <hal-00462380>

HAL Id: hal-00462380

<https://hal.science/hal-00462380v1>

Submitted on 9 Mar 2010

HAL is a multi-disciplinary open access archive for the deposit and dissemination of scientific research documents, whether they are published or not. The documents may come from teaching and research institutions in France or abroad, or from public or private research centers.

L'archive ouverte pluridisciplinaire HAL, est destinée au dépôt et à la diffusion de documents scientifiques de niveau recherche, publiés ou non, émanant des établissements d'enseignement et de recherche français ou étrangers, des laboratoires publics ou privés.



HAL Authorization

Performances and Design of Ironless Loudspeaker Motor Structures

B. Merit, G. Lemarquand and V. Lemarquand

Abstract

This paper presents several kinds of structures of ironless loudspeaker motors. The proposed devices go from simple structures, in terms of manufacturing process, to structures in which the magnet rings can be stacked, with different magnetization directions or values. The structures are studied and compared according to their created induction level and uniformity across the coil displacement range, which are directly linked to the loudspeaker performances (force factor). The model used is the coulombian model of magnets to calculate the magnetic field created, therefore all the calculations are analytical. The paper shows that no structure is universal when it comes to the loudspeaker design: some are well adapted to micro displacements of the coil while other structures are adapted to large displacements.

Index Terms

Permanent magnets, loudspeaker motor, loudspeaker performance, motor design, analytical magnetic field calculation, .

I. INTRODUCTION

L OUDSPEAKERS are widespread devices and many objects of our daily lives include one or more of them. They appeared a century ago and have of course evolved a lot, but the sound reproduction world is restlessly seeking improved loudspeakers with better integrated cabinets. What is expected from a loudspeaker? It should simply be powerful, accurate and ever smaller, lighter, with an increased acoustical quality!

Manuscript Received December 12, 2007, 2nd revision October 12, 2009. guy.lemarquand@ieee.org

The authors are with the Laboratoire d'Acoustique de l'Université du Maine UMR CNRS 6613, Avenue Olivier Messiaen, 72085 Le Mans Cedex 9, France

19 The power is linked to the acoustical flow, thus to the product of the axial displacement times the
20 section of the emissive surface. If this surface is diminished and the power remains the same, then the
21 displacement of the moving part has to be increased. In classical structures of electrodynamic loudspeakers,
22 the increase of this displacement often means the increase of nonlinear effects and distortions.

23 Numerous studies of the loudspeakers highlight that their non-linearities have four major causes [1][2]:
24 the defects of the motor, the acoustical propagation, the viscoelastic behavior of the suspension, and the
25 vibrating modes of the emissive surface and of the moving part. Many solutions have been found in order
26 to reduce these imperfections or their effects. Especially the drawbacks linked to the iron in the classical
27 motor structures have already been described (reluctant force, Eddy currents) [3] and we presented a
28 concept to get rid of them: structures of ironless loudspeaker motors [4]-[8].

29 The present paper goes further in this direction, describing different types of existing structures of
30 ironless motors and comparing their performances. Predominantly we pay our attention on their ability
31 to create a uniform induction over the axial trajectory of the coil. When this induction is uniform, the
32 force that makes the coil oscillate, and consequently the coil support and the membrane, does not depend
33 on the position of the coil anymore. Then all the non-linearities due to the motor are suppressed in such
34 ironless loudspeakers.

35 In the same way, we evaluate structures on the space they need, especially in the axial direction of the
36 loudspeaker. The more reduced the structure height is, the closer the coil can be to the cone diaphragm
37 and the shorter the moving part can be: this is an advantage in terms of vibration modes.

38 II. CONSIDERATIONS FOR THE STUDY

39 The way the structures are presented in the following study, taking into account the various geometrical
40 possibilities, is consistent with the way electrical machines are presented by Wang [9]. Many solutions
41 have been imagined and studied to create homogeneous fields in closed cavities or open spaces and we
42 meet here the same problematic [10]-[14]. Some of these structures were also applied to other purposes
43 in electrical machines [15]-[17]. The reasoning used to associate magnets to create the intended magnetic
44 field is the important and common point.

45 The structures presented are ring-shaped with rectangular sections. Then, the important point is to

46 calculate the magnetic field created by such magnets or magnet assembly. The model chosen for the
 47 magnets is the coulombian one, which uses fictitious surface and volume charge densities to represent
 48 the magnet and thus to calculate the field they create in the space in and out of the magnet [18]-[25]. It
 49 has to be noted that the formulations obtained for the three components of the field are totally analytical.
 50 This enables easy optimization of the parameters of a structure, once a criterion is chosen.

51 Two kinds of applications are considered: the high frequency loudspeakers, for which the needed coil
 52 displacements are small, and the low frequency loudspeakers, which need large coil displacements. Typi-
 53 cally, high frequency loudspeakers require peak-to-peak coil displacements smaller than $1mm$ (tweeters)
 54 or reaching $3mm$ (high medium loudspeakers); lower frequency loudspeakers can require peak-to-peak
 55 coil displacements of $10mm$ (bass medium loudspeakers) and even larger than $20mm$ (woofers).

56 The reference model usually describing the functioning of loudspeakers uses the Thiele&Small param-
 57 eters (lumped parameters) Re , Le , $B_r l$, Mms , Rms , and Kms . This useful model leads to a linear and
 58 stationary system of two differential equations:

$$\begin{cases} Re.i(t) + Le\frac{di(t)}{dt} + B_r l\frac{dz(t)}{dt} = u(t) \\ Mms\frac{d^2z(t)}{dt^2} + Rms\frac{dz(t)}{dt} + Kms.z(t) = B_r l.i(t) \end{cases} \quad (1)$$

59 However it is known that loudspeakers are highly nonlinear devices [26]. And the dependence of the
 60 force factor $B_r l$ on the displacement $x(t)$ of the coil is among the major sources of non-linearities [27].

61 This $B_r l$ product, with B_r the radial induction flowing through the coil of length l , determines not only
 62 the driving force $B_r l.i(t)$ for a given current $i(t)$, but also an electrical damping $B_r l.\frac{dz(t)}{dt} = B_r l.v(t)$
 63 of the loudspeaker connected to an amplifier with low impedance output. Thus, variation of $B_r l$ versus
 64 displacement will produce two nonlinear terms in the differential equations. In both terms, time signals
 65 are multiplied. This multiplication produces new spectral components in the output signal measured and
 66 eared as harmonic and intermodulation distortions. Fig.9 of [28] shows how critical is the non-linearity due
 67 to the force factor $B_r l$, leading to a distorted signal with high amplitudes of the harmonic components.
 68 A symmetrical variation of $B_r l$ around the rest position of the coil leads to odd-order distortions; an
 69 asymmetry leads to even-order distortions and causes 40% of intermodulation distortions in a loudspeaker
 70 [29].

Re	5.85 Ω	Le	0.856 mH	$B_r l$	9.04 T.m	Sd	120.8 cm ²
Mms	15.3g	Rms	3.1 kg.s ⁻¹	Kms	5555.6 kg.s ⁻²	fs	96 Hz

TABLE I
THIELE & SMALL PARAMETERS OF THE MEASURED AND MODELED LOUDSPEAKER.

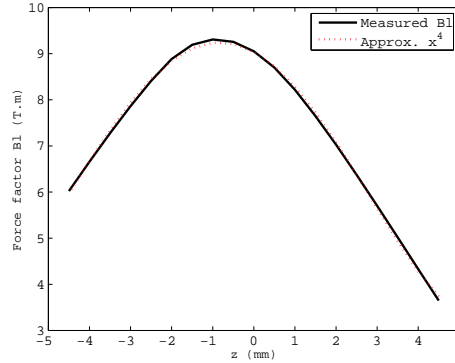

Fig. 1. Displacement-varying force factor Bl measured on the modeled loudspeaker (continuous line) and its model (dashed line).

71 A. Definition of a linearity criterion related to the force factor

72 1) Quantification of the distortions induced by a non-uniform force factor:

73 In this section, the simple linear model given by the system (1) is considered. In this system, a
74 displacement-varying model of the force factor is introduced in order to visualize its effect on the calculated
75 pressure response of a related loudspeaker. The considered lumped parameters are those of a classical
76 loudspeaker whose force factor has been measured. Table I gives these parameters, used to solve the
77 system (1).

78 The value of the force factor $B_r l$ given by Table I is only available at the rest position of the voice-coil
79 of the loudspeaker. In reality, the force factor depends on the displacement of the voice-coil, and this
80 variation is not symmetrical with the rest position, i.e. $z = 0$, of the voice-coil (continuous line in Fig.1).
81 Its model of dependence is found using a 4th order polynomial function. It well fits the values of the
82 force factor across the entire displacement range of the loudspeaker, as well as its derivative (dashed line
83 in Fig.1)

84 This model of dependence on the displacement is introduced in the system (1). The solving of this
85 system in the time domain allows the calculation of the displacement $z(t)$ of the voice-coil and of the

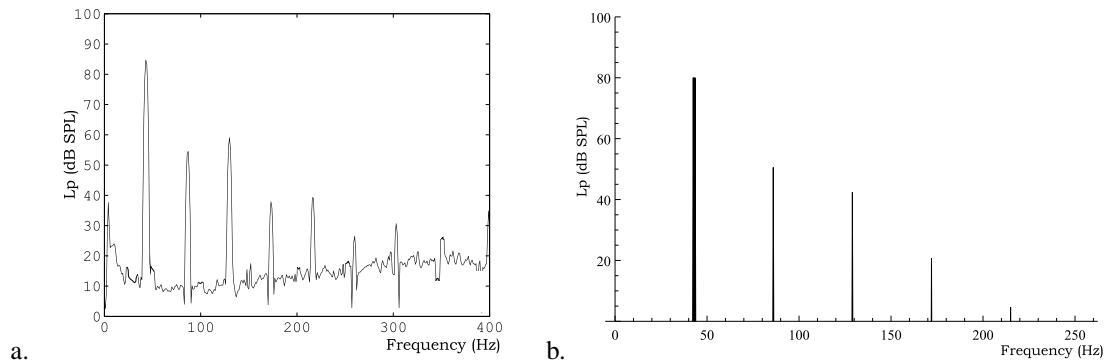

Fig. 2. a. Measured sound-pressure spectrum of the loudspeaker supplied with a $5V$ sinusoidal voltage at $43Hz$ and b. calculated sound-pressure spectrum of the nonlinear model in response to the same excitation signal.

86 electric current $i(t)$ running through the voice-coil. These later variables are used to estimate the pressure
 87 response of the loudspeaker, in time and frequency domains.

88 The sound-pressure spectrum of the loudspeaker in response to a $5V$ sinusoidal voltage at $43Hz$ has
 89 been measured (Fig.2.a). This response is compared with the calculated spectrum thanks to the model
 90 (Fig.2.b). Despite this simple model only takes into account the nonlinearities created by the force factor,
 91 it well fits the real sound-pressure spectrum of the loudspeaker: the levels of the created harmonics are
 92 quite corresponding, even if even-order harmonics are higher in the model than in reality. Thus, this model
 93 can be used to understand the contribution of a non-uniform force factor on the distorted response of a
 94 loudspeaker.

95 Fig.3 shows the time response of the voice-coil displacement to the previous excitation. The maximal
 96 reached displacement is only $1.2mm$ while the voice-coil can move with a $\pm 4mm$ displacement. To
 97 clearly see the effects of a non-uniform force factor, the excitation voltage is increased until the maximal
 98 displacement is $4mm$. When the frequency is chosen equal to $43Hz$, the $4mm$ displacement is obtained
 99 with a $16V$ excitation voltage. Fig.4 shows the calculated time responses of the voice-coil displacement
 100 and of the current intensity to this increased excitation. The time signals are clearly distorted, and obviously
 101 lead to distortions in the frequency domain (see Fig.5). This figure 4 points out another problem related
 102 to a non-uniform force factor: the loudspeaker consumes more current but its voice-coil displaces less
 103 than in the linear case, which is the proof of a waste of energy.

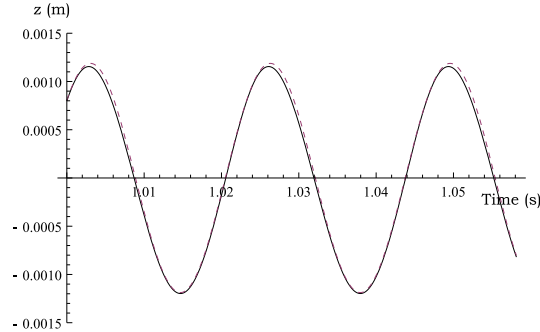

Fig. 3. Time variations of the voice-coil displacement in response to a $5V$ sinusoidal voltage at $43Hz$, calculated with the linear model (dashed line) and with the model including displacement-varying force factor (continuous line).

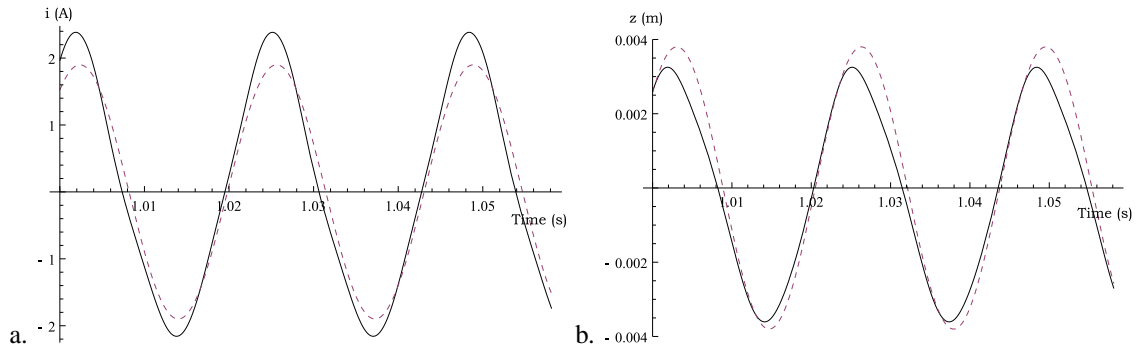

Fig. 4. Time variations a. of the current running through the voice-coil and b. of the voice-coil displacement, in response to a $16V$ sinusoidal voltage at $43Hz$, calculated with the linear model (dashed line) and with the model including displacement-varying force factor (continuous line).

104 Fig.5 is aimed to point out the harmonic and intermodulation distortions created by the loudspeaker
 105 whose force factor still varies like in Fig.1. Thus, the excitation signal is a two-tone excitation voltage:
 106 a $16V$ one at $43Hz$, to obtain the $4mm$ displacement of the voice-coil, and a $20V$ one at the arbitrary
 107 chosen frequency $500Hz$.

108 When the voice-coil displaces across its entire displacement range, high harmonic distortion and
 109 intermodulation distortions are produced, because of the displacement-varying force factor. The higher
 110 harmonic component at $129Hz$ is only $18dB$ lower than the fundamental at $43Hz$, and $13dB$ lower
 111 than the fundamental at $500Hz$. The higher intermodulation component at $414Hz$ is only $19dB$ lower
 112 than the fundamental at $500Hz$ and $24dB$ lower than the fundamental at $43Hz$. With only two tones,
 113 the non-uniform force factor $B_r l$ induces a lot of distortions, most of them being potentially audible or

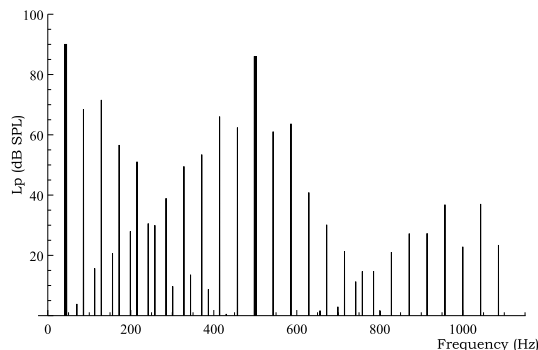

Fig. 5. Sound-pressure spectrum of the nonlinear loudspeaker model to a two-tone excitation voltage at 43Hz (16V) and 500Hz (20V).

114 disturbing for some applications [30],[31]. These effects are reinforced when talking about low frequency
 115 drivers, for which the displacements of the voice-coil are large, and for which the design of the motor
 116 becomes very difficult. But the distortions caused by a non-uniform force factor are also discussed in high
 117 frequency drivers [32].

118 These are the reasons why it is important to search for loudspeaker motors able to induce force
 119 factors $B_r l$ that do not depend on the displacement of the coil. The first step to the decrease of the
 120 nonlinearities due to the force factor can be to make its dependence on the displacement symmetrical
 121 with the rest position of the voice-coil. Thus, from the measured force factor, a model of force factor with
 122 symmetrical dependence on the displacement we call *symmetrical-made force factor* is obtained (Fig.6).
 123 This symmetrical-made force factor has a 48% maximal peak-peak variation across a $\pm 4\text{mm}$ range. As
 124 expected, Fig.7 shows that each even-order harmonic component is removed. In classical loudspeaker
 125 motors, making a symmetrical force factor is very difficult: it means creating a symmetrical magnetic
 126 induction in the airgap around the rest position of the voice-coil. The presence of iron makes this operation
 127 very difficult, and designers use tricks to evade this problem [33].

128 When the magnetic circuit is only made of magnets, the symmetry of the force factor is simply obtained
 129 thanks to the symmetry of the magnets disposition. In the sequel, we consider that the modeled loudspeaker
 130 creates a symmetrical magnetic induction in the airgap. To study the influence of the variation percentage
 131 of the force factor on the creation of distortions, we make its maximal variation vary from 48% (Fig.6
 132 and Fig.7) to 1% across a $\pm 4\text{mm}$ range. In Fig.8, the measured symmetrical-made force factor of the

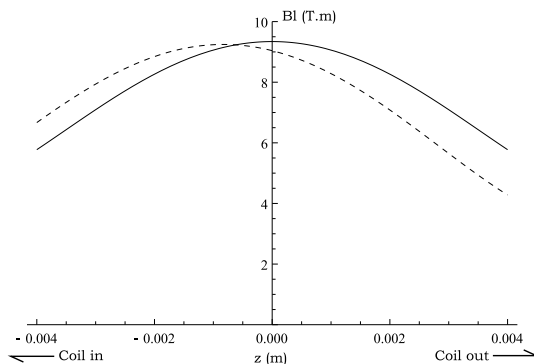

Fig. 6. Asymmetrical measured force factor of the loudspeaker (dashed line) and symmetrical-made force factor (continuous line) as a function of the voice-coil displacement.

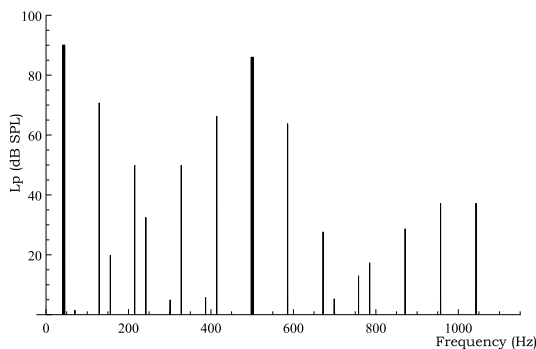

Fig. 7. Sound-pressure spectrum of the nonlinear loudspeaker model with the symmetrical-made force factor to a two-tone excitation voltage at 43Hz (16V) and 500Hz (20V).

133 real loudspeaker (thick line) has a 48% peak-peak variation, and is made even more uniform until 1%
 134 peak-peak variation.

135 Fig.9 to Fig.13 show the sound-pressure spectra of the modeled loudspeaker whose force factor maximal
 136 variation goes respectively from 30% to 1%, in response to a two-tone excitation voltage.

137 From 30% to 1%, the improvement in the reduction of the harmonic and intermodulation components
 138 is as much logical than necessary. When the $B_r l$ maximum variation reaches 1%, the higher harmonic
 139 and intermodulation components are 50dB lower than the fundamental components. The intermodulation
 140 components are known to be more disturbing than the harmonic components, as much in the signal
 141 generated by the loudspeaker [34]-[36] than in the auditive electric signal created by the ear itself [37].
 142 That is why it is important to decrease these components as much as possible. Thus, searching for an

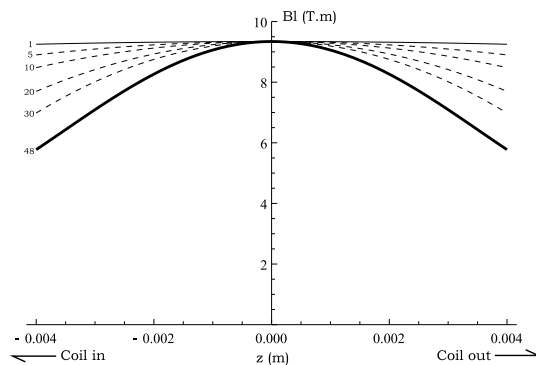

Fig. 8. Models of force factor as a function of the voice-coil displacement, and whose maximal peak-peak variation varies from 48% (thick line) to 1% (continuous line) across a $\pm 4mm$ range. Dashed lines represent force factors with 30% to 5% maximal variation across the $\pm 4mm$ range.

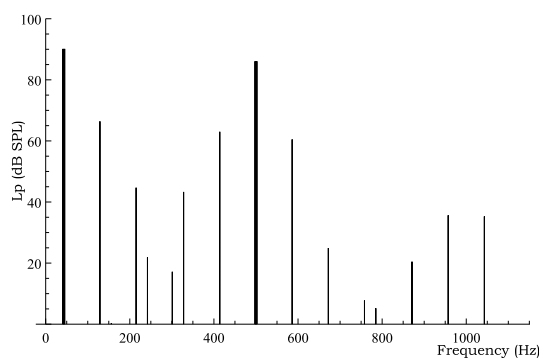

Fig. 9. Sound-pressure spectrum of the nonlinear loudspeaker model whose force factor has a maximal variation of 30% in response to a two-tone excitation voltage at $43Hz$ (16V) and $500Hz$ (20V).

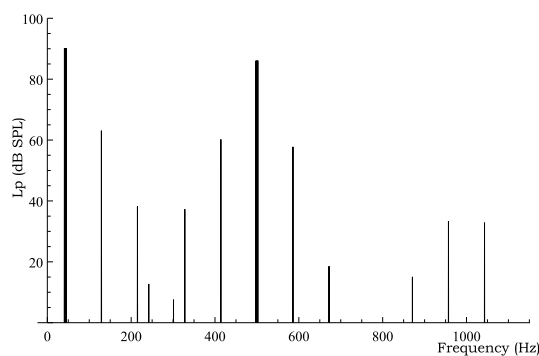

Fig. 10. Sound-pressure spectrum of the nonlinear loudspeaker model whose force factor has a maximal variation of 20% in response to a two-tone excitation voltage at $43Hz$ (16V) and $500Hz$ (20V).

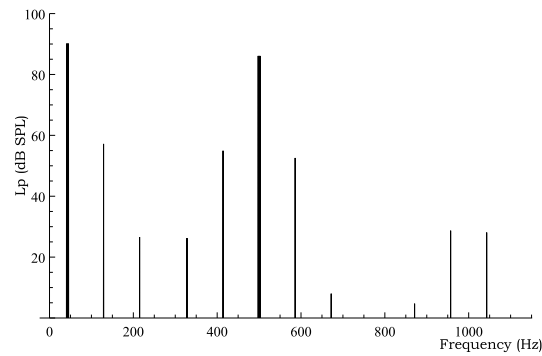

Fig. 11. Sound-pressure spectrum of the nonlinear loudspeaker model whose force factor has a maximal variation of 10% in response to a two-tone excitation voltage at 43Hz (16V) and 500Hz (20V).

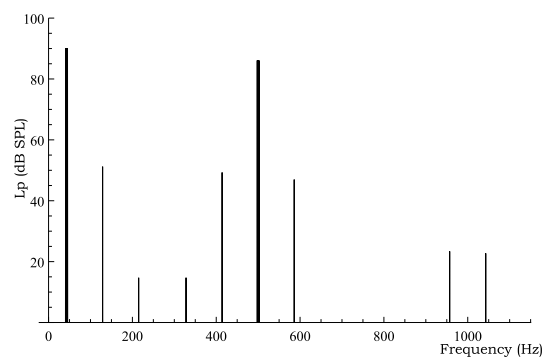

Fig. 12. Sound-pressure spectrum of the nonlinear loudspeaker model whose force factor has a maximal variation of 5% in response to a two-tone excitation voltage at 43Hz (16V) and 500Hz (20V).

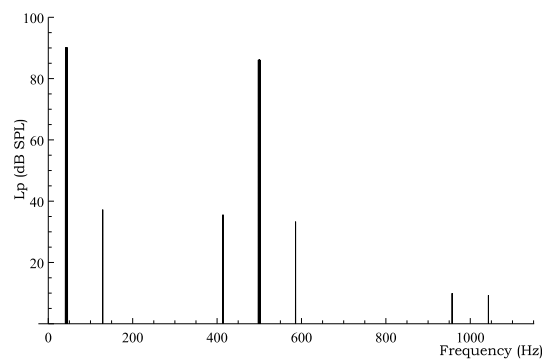

Fig. 13. Sound-pressure spectrum of the nonlinear loudspeaker model whose force factor has a maximal variation of 1% in response to a two-tone excitation voltage at 43Hz (16V) and 500Hz (20V).

143 accurate loudspeaker motor is searching for a perfectly uniform force factor, whose maximal variation is
144 0% along the displacement range of the voice-coil. The constraints in the dimensioning of a traditional
145 magnetic circuit imply that the designers would be largely satisfied with a variation of 1%, given the low
146 levels of the intermodulation components.

147

148 2) *Definition of the linearity criterion z_{uni} :*

149 The best way to the ideal 0%-variation force factor is to search for a symmetrical ironless motor
150 structure, which is able to create a magnetic field whose radial component is very uniform along the
151 trajectory of the coil. Ideally, for an accurate and space-saving loudspeaker motor, a magnetic structure
152 should create a perfectly uniform induction - i.e. with 0% variation - across a distance as large as the total
153 height of the structure. This ideal structure is not realistic and we present in this paper existing structures
154 that may approach the ideal case by optimizing their characteristics and by suffering a 1% peak-to-peak
155 variation. It is not necessary to reach smaller variations than 1%: on the one hand the magnetization of
156 the currently available magnets is not really uniform itself. And on the other hand, especially in the case
157 of underhung loudspeakers, the force that makes the voice-coil oscillate is related to the mean value of the
158 magnetic induction over the coil height (the coil height is the axial length of the coil). Therefore, if the
159 induction variation across a range of displacement that interests us does not exceed 1%, then the maximal
160 force factor variation may not exceed 1%. We have seen in the previous section that such a displacement-
161 varying force factor is acceptable when looking at the level of the intermodulation components. That is
162 why we consider that an induction with a 1% peak-to-peak maximal variation is sufficient to design an
163 acceptable loudspeaker motor.

164 Thus, for the study, let us consider a parameter we call z_{uni} . Given a structure, this parameter represents
165 the axial distance across which the created magnetic induction seen by the coil has a peak-to-peak variation
166 smaller than 1%. Thus, across this distance, the induction and then the force factor are considered uniform.
167 In classical loudspeakers, the $B_r l$ variation and the induction variation easily exceed 10% across a distance
168 that corresponds to the trajectory of the coil; that is why significant nonlinear effects are produced and it
169 is important to search for structures that lead to more uniform induction.

170 In the considered applications, the coil moves in a direction, Oz , parallel to the revolution axis of

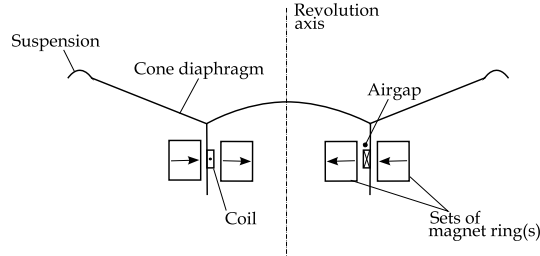

Fig. 14. General composition of an ironless loudspeaker; here the magnet structure is made with two sets of one magnet ring.

171 the loudspeaker (see Fig.14): the induction has to be uniform along this direction. Oz is the observation
 172 axis, placed in the airgap at a location that corresponds to the mean value of the coil thickness (the coil
 173 thickness is the radial length of the coil).

174 III. SMALL DISPLACEMENTS LOUDSPEAKERS

175 The coil of a loudspeaker generally moves with small amplitudes at high frequencies. The following
 176 sections present the structures which are well adapted to these displacements. As the devices are often
 177 intended to be small themselves [38], we consider structures with only one outer set of magnet ring(s) and
 178 an inner coil (see Fig.15). The origin O of the observation axis Oz corresponds to the center of the coil
 179 when this latter is in its equilibrium position. The induction is observed at a radial distance $a/2 = 0.3mm$
 180 from the magnet ring(s). We compare structures that have approximately the same magnet volume with
 181 regard to their ability to create a uniform induction.

182 A. Two axially magnetized permanent magnets: the simplest structure

183 Structure *A* of Fig.15 shows an ironless structure constituted by two axially magnetized rings. These
 184 rings are concentric, placed one above the other, and separated with an airgap of thickness e . Their
 185 respective magnetization are in repulsion -the facing poles are of the same kind-. The coil is centered in
 186 front of the airgap e and the magnetic flux in the coil is then expected to be radial.

187 This kind of structure has been patented by the Harman society [39]. The main advantage of this structure
 188 is its simple manufacturing process, because it only requires classical axially magnetized permanent
 189 magnets.

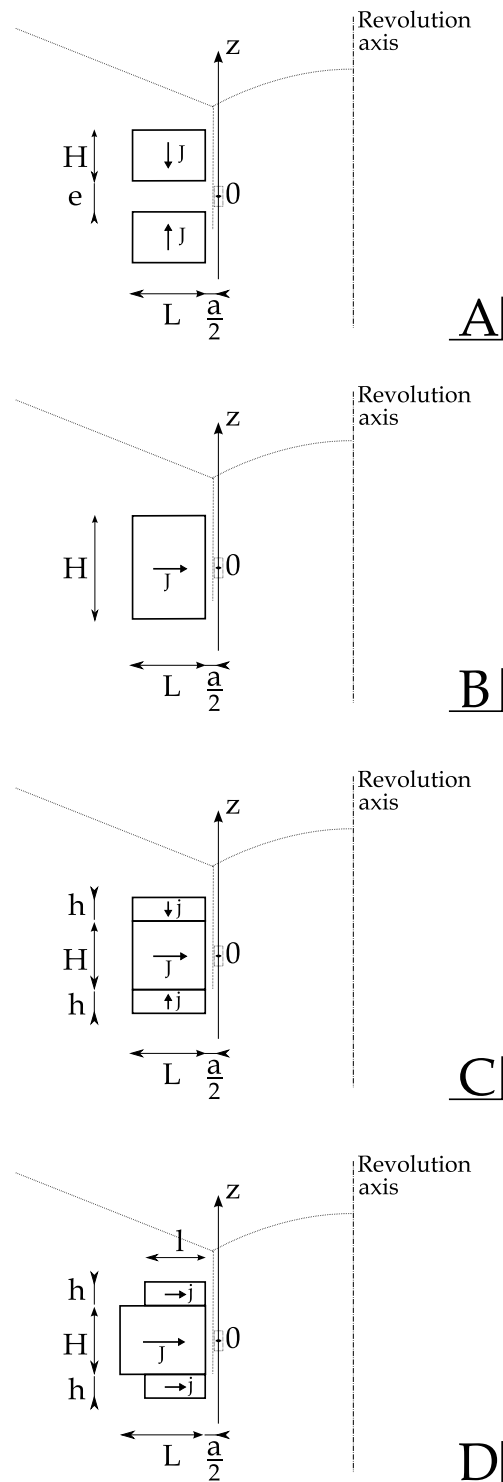

Fig. 15. Ironless motor structures for small displacements. The coil is located on the observation axis Oz and has an oscillating movement centered on the 0 point.

A: two axially magnetized rings

B: one radially magnetized ring

C: one radially magnetized ring and two axially magnetized rings

D: three radially magnetized rings

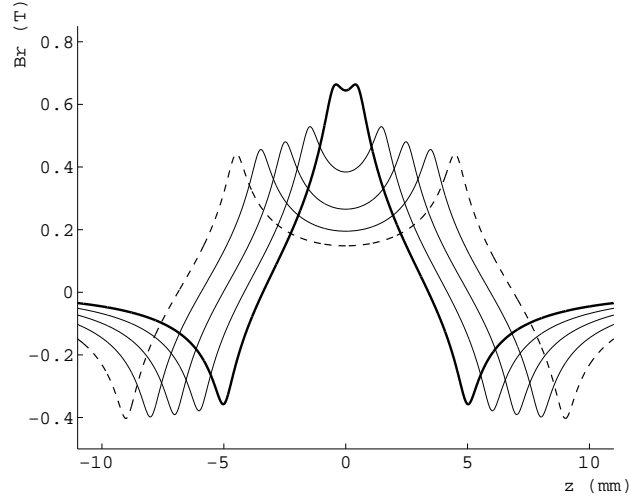

Fig. 16. Radial magnetic induction, B_r (T), along the observation axis at a distance $a/2 = 0.3\text{mm}$, created by the structure A for $H = 4.5\text{mm}$, $L = 9\text{mm}$ and for various values of the distance between the magnets, from top to bottom, $e = 1\text{mm}$ (bold line), 3mm , 5mm , 7mm and 9mm (dashed line).

190 Fig.16 shows the global induction behavior when the magnets deviate. The induction intensity and the
 191 possible linear coil displacement z_{uni} decrease when e decreases. For example, when the magnets are
 192 close to each other (see the solid bold line in Fig.16), the induction is intense (up to $0.6T$) but the distance
 193 z_{uni} is so small that it is not convenient to represent it on the curve.

194 Thus, this structure is simple but, to prevent nonlinear phenomena, it should only be dedicated to
 195 tweeters for which the needed coil displacements are small.

196 *B. One permanent magnet ring radially magnetized.*

197 Let us consider the structure B of Fig.15. It is constituted by one ring facing the moving coil. Ideally
 198 the ring is made in a radially magnetized permanent magnet. For a simpler design, it can also be made up
 199 of permanent magnet tiles - the same that are used in electrical machines- which are radially magnetized.

200 Previous studies [5] on the induction created by a rectangular magnet show that a good combination
 201 between its dimensions can always lead to a quite uniform induction in front of the magnets. In the best
 202 case, the axial distance z_{uni} is about 60% of the considered magnet height.

203 Fig.17 shows that, for a given length, the induction can be quite constant over an axial range if the
 204 magnet height is sufficient (dot-dashed line in Fig.17). This figure can also be interpreted alternately: it

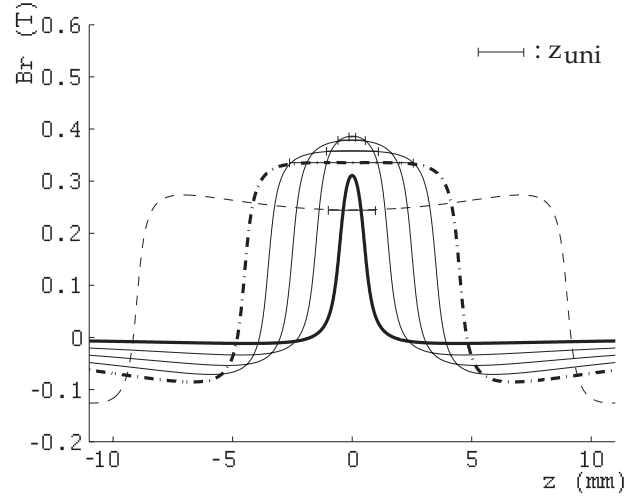

Fig. 17. Radial magnetic induction, B_r (T), along the observation axis at a distance $a/2 = 0.3mm$, created by the structure B for $L = 9mm$ and for various values of the height: $H = 1mm$ (bold line), then from top to bottom $H = 3mm, 5mm, 7mm, 9mm$ (dot-dashed line) and $H = 18mm$ (dashed line).

205 shows that small height magnets produce an important induction over short axial areas (see bold line in
 206 Fig.17). This localized action will be useful in further structures.

207 A structure B of $9mm$ long and $9mm$ high is now compared to the structure A proposed in the
 208 previous section: the magnet volume is the same in both structures. For the structure B , the induction is
 209 uniform over a range of $\pm 2.7mm$ along the Oz axis around the middle of the magnet with a variation
 210 of 1% - so $z_{uni} = 5.4mm$ -. The induction intensity in front of the middle of the magnet is $0.33T$ with
 211 a magnet magnetization of $1T$ and with a magnet section of $81mm^2$. The behavior difference compared
 212 to the structure A is obvious: the induction level is smaller but is uniform over a significant range. If
 213 the length of the magnet decreases, the uniformity distance z_{uni} decreases. z_{uni} equals about $4mm$ for
 214 a $7mm$ length, and $1.6mm$ for a $5mm$ length. We conclude that the magnet length cannot go below a
 215 given value when the variation has to remain to one percent. If smaller, the magnet will not be well used.
 216 In fact, the set $L = H = 9mm$ is the optimum in this case.

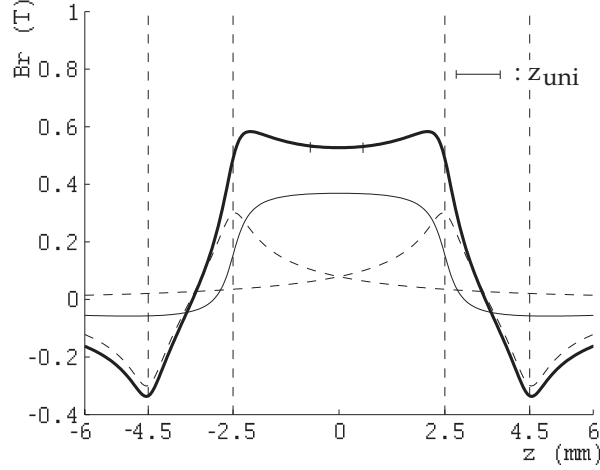

Fig. 18. Radial magnetic induction, B_r (T), along the observation axis at a distance $a/2 = 0.3\text{mm}$, created by the structure C (bold line) with its central magnet with $H = 5\text{mm}$, $L = 8\text{mm}$, $J = 1\text{T}$ (full line) and its two external magnets with $h = 2\text{mm}$, $l = 8\text{mm}$, $j = 1\text{T}$ (dashed line).

217 C. Combination of magnet rings

218 The Sony society patented the structure C of Fig.15 [40]. It is constituted by a stack of three magnet
 219 rings of equal length. It is notable that such stacked structures were proposed to enhance the performances
 220 of other applications such as passive magnetic bearings [41]. The central ring is radially magnetized while
 221 the external rings are axially magnetized and their magnetization directions help the total magnetic flux
 222 to close. According to the patent, the three magnetizations of the central ring, J , and of the external ones,
 223 j , are equal.

224 Let us consider the dimensions of the structure given in the patent: $H = 5\text{mm}$, $h = 2\text{mm}$, $L = 8\text{mm}$,
 225 with a magnetization of 1T . Fig.18 shows the induction calculated along the observation axis created by
 226 the whole structure (bold line) and by the separated elements. This induction is not really uniform. Its
 227 central value is 0.5T . The induction variation along the Oz axis over a range corresponding to the height
 228 of the central magnet represents 19% of the central value. Because of this significant variation, z_{uni} is
 229 only 1.28mm , that is 14% of the total height of the structure. Note that the induction variation is 10%
 230 across the distance of 4.2mm that separates the two maxima of this induction.

231 The structure C , which is 11% more compact than the previous optimal structure B , produces a more

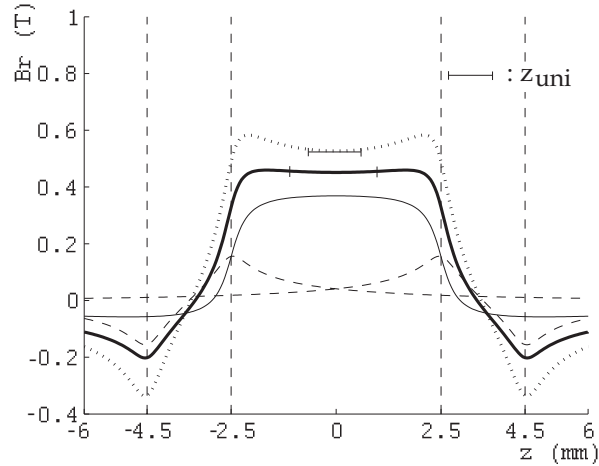

Fig. 19. Radial magnetic induction, B_r (T), along the observation axis at a distance $a/2 = 0.3mm$, created by the structure C as patented (dotted line) and by the structure C with lowered magnetizations (bold line); this structure uses a central magnet with $L = 8mm$, $H = 5mm$ and $J = 1T$ (full line) and two external magnets with $l = 8mm$, $h = 2mm$ and $j = 0.52T$ (dashed line).

232 intense induction but with a larger induction variation. The induction increases by 34% while the distance
 233 z_{uni} decreases by 76% compared to the optimal structure B .

234 The principal advantage of the structure C is then its ability to create really high induction levels while
 235 using relatively small magnet volumes. Despite its induction variation, the structure C has on this point a
 236 substantial lead over the structure A . Nevertheless, because of its small z_{uni} , and taking into account the
 237 behavior of its created induction, we conclude that the structure C should be used for tweeters or high
 238 medium loudspeakers only.

239 In addition, Fig.19 shows that the total induction created by the structure C can be more uniform if
 240 the magnetization of the external rings is smaller than the magnetization of the central ring. Fig.18 shows
 241 the contribution of each ring to the total induction and especially that the external rings (see dashed line
 242 in Fig.18) provide a really high magnetic induction compared to the induction provided by the central
 243 ring. Fig.19 shows the result when the external magnetizations are lowered to $0.52T$. In this case z_{uni}
 244 equals $2.1mm$, and the induction variation is 1.8% across the $3.4mm$ distance that separates the two
 245 maxima of this induction. The uniformity improvement is significant but leads to a 8% decrease of the
 246 total induction.

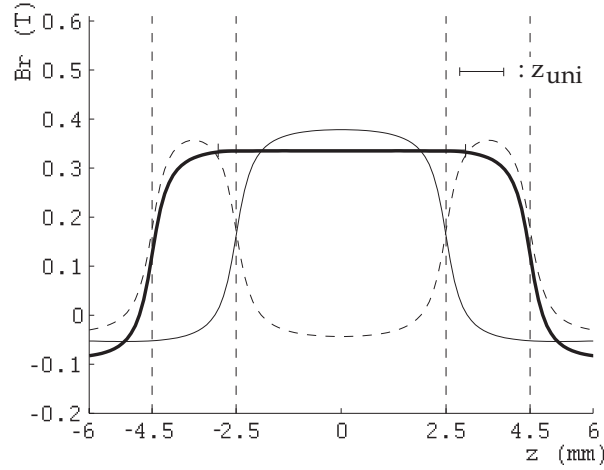

Fig. 20. Radial magnetic induction, B_r (T), along the observation axis at a distance $a/2 = 0.3\text{mm}$, created by the structure D (bold line) with its central magnet with $H = 5\text{mm}$, $L = 9\text{mm}$, $J = 1\text{T}$ (full line) and its two external magnets with $h = 2\text{mm}$, $l = 9\text{mm}$, $j = 1.01\text{T}$ (dashed line).

247 D . Several magnetizations

248 The structure D of Fig.15 goes further in the idea of using magnets whose magnetizations differ in
 249 order to give the intended flat shape to the observed induction. Like the structure C , it is constituted by
 250 one set of three stacked magnet rings, but their magnetizations are all radial. The purpose of the induction
 251 created by the external rings is to compensate the bell shape of the induction created by the central ring.
 252 This is achieved by combining the higher magnetization of the external rings and their small height to
 253 use their very localized action (as described in Fig.17).

254 Fig.20 shows the contribution of each ring and the resulting total induction (bold line). The set of
 255 dimensions is chosen in order to have the same magnet section as the one of the previous optimal
 256 structure B (81mm^2). The resulting induction has a z_{uni} of 6.4mm , which represents 67% of the total
 257 height of the structure. In fact, z_{uni} is larger than the height of the central magnet because the structure is
 258 calculated in order to create the most uniform possible induction across the height of the central magnet;
 259 across H , the induction variation is only 0.1%.

260 In this case, the performance difference between both structures B and D is not significant, but it is
 261 important to note that the structure D can be optimized. Indeed, the distance z_{uni} can always correspond

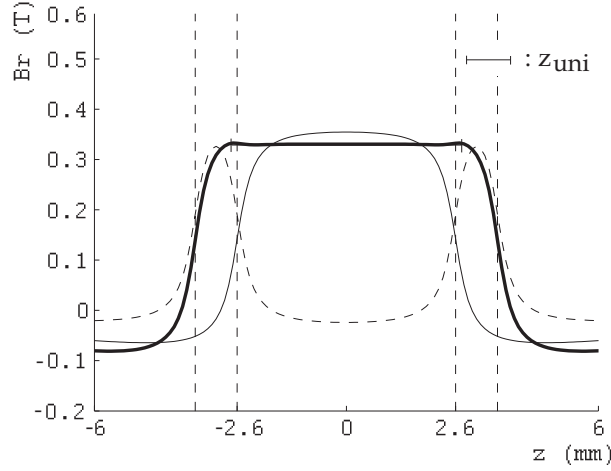

Fig. 21. Radial magnetic induction, B_r (T), along the observation axis at a distance $a/2 = 0.3mm$, created by the structure D (bold line) with its central magnet with $H = 5.2mm$, $L = 7mm$, $J = 1T$ (full line) and its two external magnets with $h = 1mm$, $l = 8.5mm$, $j = 1.09T$ (dashed line).

262 to the dimension H , so the starting point of the optimization is facilitated by this occurrence: the intended
 263 z_{uni} fixes the height of the central ring. The other dimensions and magnetizations are calculated in order
 264 to optimize the volume of the whole structure and the uniformity and the intensity of the magnetic field.

265 The previous geometry has been optimized in order to obtain an induction of equal intensity and
 266 having about the same z_{uni} of $5.4mm$. The optimal dimensions we find correspond to a more space-
 267 saving structure whose total height is $7.2mm$. The total section of this structure D is $53.4mm^2$ (34%
 268 decrease compared to the previous section). The created induction reaches $0.33T$ and the distance z_{uni}
 269 is $5.4mm$ (see Fig.21).

270 The structure D is now compared to the structure C : the magnet volume is kept constant for both
 271 structures (Fig.22). The dimension $H = 4mm$ of the structure D is arbitrary chosen so that z_{uni}
 272 approximately corresponds to the distance between the two maxima of the induction created by the
 273 structure C .

274 While the total height of the structure D is $7mm$, that is $2mm$ less than the structure C , z_{uni} equals
 275 $4.2mm$. This represents a significant improvement compared to the distance z_{uni} of $1.28mm$ obtained
 276 with the structure C .

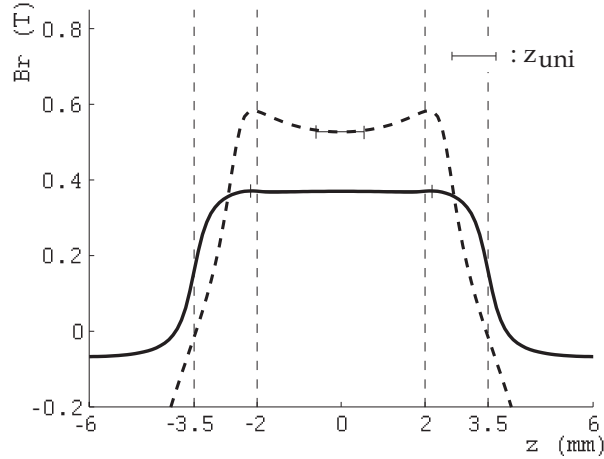

Fig. 22. Radial magnetic induction, B_r (T), along the observation axis at a distance $a/2 = 0.3mm$, created by the structure D (bold line) with its central magnet with $H = 4mm$, $L = 10.5mm$, $J = 1T$ and its two external magnets with $h = 1.5mm$, $l = 10mm$, $j = 1.05T$, and by the structure C as patented (dashed line).

277 The induction created by the structure D reaches $0.37T$, which represents a 37% decrease compared
 278 to the induction created by the structure C . Of course, the volume of the structure D can be optimized.
 279 But, whatever the configuration is, it is not possible to reach an induction as intense as the one created
 280 by the structure C without using big magnets. The reason is that the external rings of the structure D are
 281 strictly compensation rings.

282 As a result, the structures D , with several magnetizations, lead to very compact devices that have a
 283 very uniform induction over a range that can be chosen. They allow the miniaturization of the device as
 284 well as a linear functioning, since a small coil easily remains in a uniform induction. The structure D
 285 and the structure B are well adapted to small displacements loudspeakers, but, thanks to their large z_{uni} ,
 286 they are not limited to these loudspeakers.

287 IV. LARGE DISPLACEMENTS LOUDSPEAKERS

288 When fed with low frequencies, the coil of a loudspeaker moves with large amplitudes. So, the motor
 289 has to have good performances for large coil displacements. The requirements are more demanding than in
 290 the previous structures, since nonlinear effects increase with large displacements. The ironless structures
 291 which are well adapted to these requirements, that is displacements larger than $20mm$, are presented in the

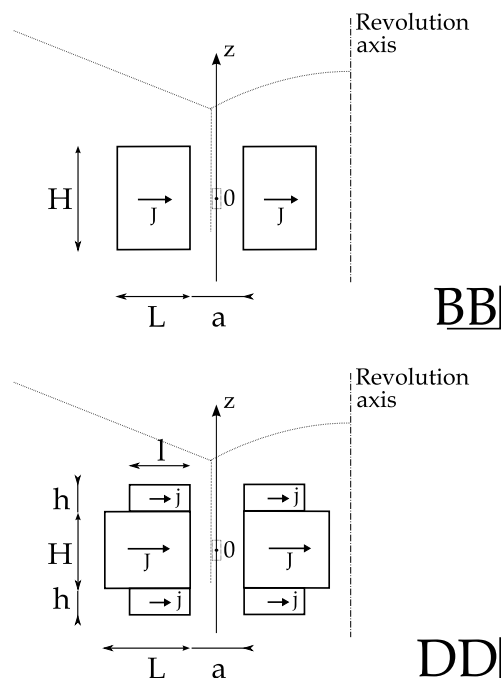

Fig. 23. Ironless motor structures for large displacements. The coil has an axial oscillating movement centered on the point 0.
 BB: two radially magnetized rings
 DD: two sets of three radially magnetized rings

292 following section. Given the conclusions of the first part concerning small displacements, and according
 293 to our calculations, the only structures that are well adapted to large and linear displacements are those
 294 inspired from the structures *B* and *D*, as shown on Fig.23. Structures inspired from the structures *A*
 295 et *C* cannot be adapted for large displacements. Indeed the axially magnetized rings do not have effect
 296 anymore on the total induction when these two rings are too far from each other.

297 Hence, this section considers motor structures which are constituted by two sets of magnet ring(s)
 298 separated by an airgap where the moving coil is located. Having one or two sets of ring(s) does not
 299 change the behavior of the device, especially the uniformity of the field. However the induction intensity
 300 is increased. The calculation method is the same, as the superimposition theorem applies. The induction
 301 is calculated at a radial distance $a/2 = 2mm$ from the magnets.

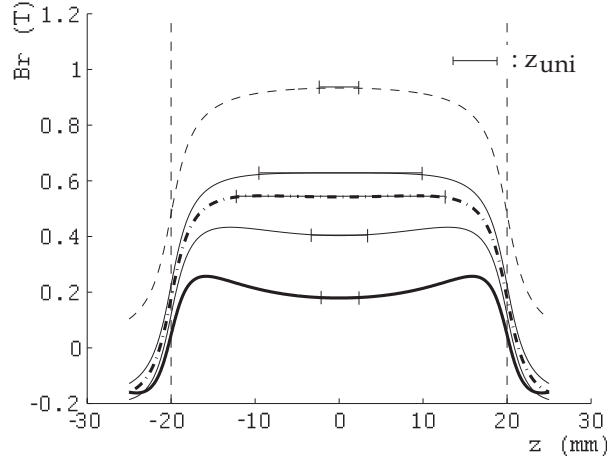

Fig. 24. Radial magnetic induction, B_r (T), along the observation axis at a distance $a = 2mm$, created by the structure BB for $H = 40mm$ and for various values of the length, from bottom to top, $L = 6mm$ (bold line), $16mm$, $26mm$ (dot-dashed line), and $36mm$, and by the nearest face from the coil (dashed line).

302 *A. Two permanent magnet rings radially magnetized.*

303 Let us consider the structure BB of Fig.23. This structure derives from the structure B . Of course the
 304 behavior of this structure is the same as the one of the structure B presented for small displacements.
 305 Fig.24 illustrates the dimensioning of the device for large displacements.

306 For an arbitrary chosen magnet height of $40mm$, and a length of $26mm$, the induction is uniform over
 307 a range of $\pm 12.5mm$ along the Oz axis around the point O with a variation of 1%: $z_{uni} = 25mm$, which
 308 represents 63% of the height of the structure. The induction reaches $0.54T$ in front of the middle of the
 309 rings for a magnet magnetization of $1T$. The section of one magnet ring is $10.4cm^2$. Note that the length
 310 $L = 26mm$ is the optimal length for this configuration: with other lengths, z_{uni} decreases.

311 *B. Several magnetizations.*

312 As it is natural to try to improve the performance of a device, the structure DD of Fig.23 is considered
 313 now. It is derived from the structure D by concentrically placing two sets of three radially magnetized
 314 rings. Its behavior is the same as described in section III-D.

315 The previous structure BB of $40mm$ high and $26mm$ long is compared with the structure DD . First,
 316 the magnet volume is kept constant for both structures (Fig.25). The chosen parameters for the structure

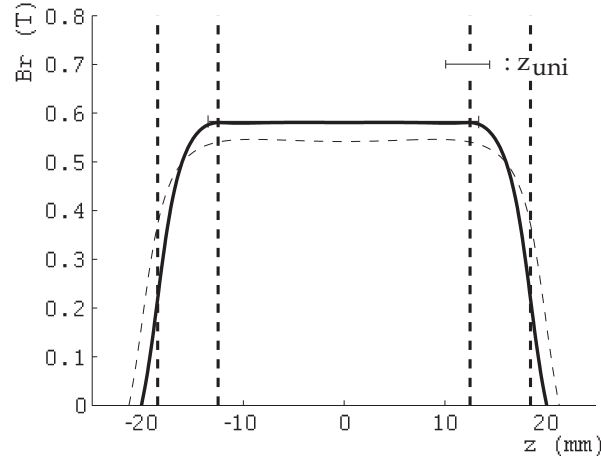

Fig. 25. Radial magnetic induction, B_r (T), along the observation axis at a distance $a = 2mm$, created by the structure DD (bold line) with its central rings with $H = 25mm$, $L = 30mm$, $J = 1T$ and its four external rings with $h = 6mm$, $l = 24mm$, $j = 1.07T$, and by the structure BB with $H = 40mm$, $L = 26mm$, $J = 1T$ (dashed line).

317 DD are: $H = 25mm$, $L = 30mm$ and $J = 1T$ for the central rings, and $h = 6mm$, $l = 24mm$, and
 318 $j = 1.07T$ for the external rings. With a smaller height, then with a larger length, the structure DD
 319 provides a more constant induction that reaches $0.58T$. This is 7.5% higher than the induction intensity
 320 reached by the structure BB . z_{uni} is larger than $25mm$: it represents 71% of the total height of the
 321 structure. Thus, this structure DD is more competitive but it is important to note that its external rings
 322 need a magnetization $j = 1.07T$.

323 The geometry of the structure DD is now optimized in order to reduce its volume. The new parameters
 324 for the structure are: $H = 25mm$, $L = 25mm$ and $J = 1T$ for the central rings, and $h = 5mm$,
 325 $l = 20mm$, and $j = 1.09T$ for the external rings. Fig.26 compares this structure DD to the same
 326 previous structure BB . The created induction reaches $0.55T$ and z_{uni} is still larger than $25mm$. The
 327 total magnet section of one set of the structure DD equals $8.25cm^2$. This represents a 21% decrease
 328 compared to the structure BB . While the total volume of the structure DD is considerably reduced, its
 329 created induction is similar to the induction created by the structure BB , as much for its intensity as for
 330 its uniformity.

331 As for small displacements, the methodology for dimensioning the structure DD is rather simple: the
 332 maximal displacement of the coil gives the height of the central rings, if the induction is intended to be

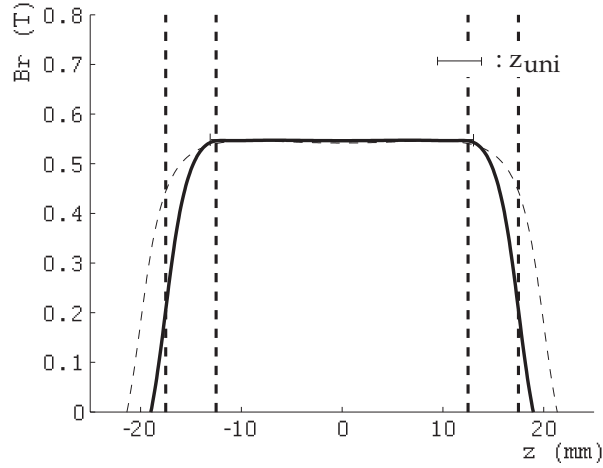

Fig. 26. Radial magnetic induction, B_r (T), along the observation axis at a distance $a = 2\text{mm}$, created by the structure DD (bold line) with its central rings with $H = 25\text{mm}$, $L = 25\text{mm}$, $J = 1\text{T}$ and its four external rings with $h = 5\text{mm}$, $l = 20\text{mm}$, $j = 1.09\text{T}$, and by the structure BB with $H = 40\text{mm}$, $L = 26\text{mm}$, $J = 1\text{T}$ (dashed line).

333 uniform over the whole displacement. Even in the case of large displacements, the optimization of the
 334 structure volume leads to compact devices that create very uniform inductions.

335 V. CONCLUSION

336 This paper presents several kinds of ironless structures of loudspeakers. The principal point of compari-
 337 son between them is their ability to create a uniform induction. Based on this point, their study distinguishes
 338 the structures dedicated to small coil displacements and the ones that can also be dedicated to large coil
 339 displacements. While structures A and C should only be integrated in high frequency loudspeakers, it
 340 appears that structures B and D are more universal: their dimensions can be adjusted to correspond to
 341 small displacements (structures B and D) as well as large displacements (structures BB and DD).

342 Then, compromises are to be done between the difficulties in manufacturing the structure, its total
 343 magnet volume and of course the intensity and the uniformity of its created induction. The structure A is
 344 the simplest structure to realize. But the technologies advancement makes radial magnetizations become
 345 more and more common, so that structures B , C and D are easy to realize. The volume of the magnet
 346 structure is an obstruction criterion as well as a price criterion; the structure D well answers to both
 347 criterions. For efficient loudspeakers, the important point is the intensity of the induction. Both structures

348 A and C create intense inductions in their reduced application domain. But the important point to obtain
 349 a good sound quality is to have a uniform induction over the whole excursion range of the coil. Whatever
 350 the range is, structures B and D , and then BB and DD , permit to obtain more accurate loudspeakers.

REFERENCES

- [1] W. Cunningham, "Nonlinear distortion in dynamic loudspeakers due to magnetic effects," *J.Acoust.Soc.Am.*, vol. 21, pp. 202–207, 1949.
- [2] M. Gander, "Moving-coil loudspeaker topology as an indicator of linear excursion capability," *J. Audio Eng. Soc.*, vol. 29, 1981.
- [3] J. Vanderkooy, "A model of loudspeaker driver impedance incorporating eddy currents in the pole structure," *J. Audio Eng. Soc.*, vol. 37, pp. 119–128, March 1989.
- [4] M. Berkouk, V. Lemarquand, and G. Lemarquand, "Analytical calculation of ironless loudspeaker motors," *IEEE Trans. Magn.*, vol. 37, pp. 1011–1014, March 2001.
- [5] G. Lemarquand, "Ironless loudspeakers," *IEEE Trans. Magn.*, vol. 43, pp. 3371–3374, August 2007.
- [6] R. Ravaut, G. Lemarquand, V. Lemarquand, and C. Depollier, "Ironless loudspeakers with ferrofluid seals," *Archives of Acoustics*, vol. 33, pp. 3–10, 2008.
- [7] B. Merit, G. Lemarquand, and V. Lemarquand, "In pursuit of increasingly linear loudspeaker motors," *IEEE. Trans. Mag.*, vol. 45, no. 6, pp. 2867–2870, 2009.
- [8] R. Ravaut and G. Lemarquand, "Modelling an ironless loudspeaker by using three-dimensional analytical approaches," *Progress in Electromagnetics Research, PIER 91*, pp. 53–68, 2009.
- [9] J. Wang, G. Jewell, and D. Howe, "Design optimisation and comparison of permanent magnet machines topologies," vol. 148, pp. 456–464, *IEEE Proc. Elect. Power Appl.*, Sept 2001.
- [10] K. Halbach, "Design of permanent multiple magnets with oriented rec material," *Nucl. Inst. Meth.*, vol. 169, pp. 1–10, 1980.
- [11] M. Abele and H. Leupold, "A general method for flux confinement in permanent magnet structure," *J. Appl. Phys.*, vol. 64, no. 10, pp. 5988–5990, 1988.
- [12] M. Abele, J. Jensen, and H. Rusinek, "Generation of uniform high fields with magnetized wedges," *IEEE Trans. Magn.*, vol. 33, no. 5, pp. 3874–3876, 1997.
- [13] J. Jensen and M. Abele, "Generation of highly uniform magnetic fields with magnetized wedges," *IEEE Trans. Magn.*, vol. 34, no. 4, pp. 2316–2323, 1998.
- [14] R. Ravaut and G. Lemarquand, "Discussion about the magnetic field produced by cylindrical halbach structures," *Progress in Electromagnetics Research B*, vol. 13, pp. 275–308, 2009.
- [15] L. Maosan, S. Caitu, C. Renhuai, W. Wentai, and Z. Jiemin, "Magnetic field analysis of rec devices with gradually varied magnetizations," in *Proc. Of the 7 th Int. Workshop on RE Magnet and Their Applications, San Diego, CA, USA*, pp. 165–173, 1983.
- [16] M. Marinescu and N. Marinescu, "New concept of permanent magnet excitation for electrical machines. analytical and numerical computation," *IEEE Transactions on Magnetics*, vol. 28, pp. 1390–1393, march 1992.

- [17] Z. Zhu, G. Jewell, and D. Howe, "Design considerations for permanent magnet polarised electromagnetically actuated brakes," *IEEE Transactions on Magnetics*, vol. 31, pp. 3743–3745, november 1995.
- [18] E. Furlani, S. Reznik, and A. Kroll, "A three-dimensional field solution for radially polarized cylinders," *IEEE Trans. Magn.*, vol. 31, pp. 844–851, Jan. 1995.
- [19] J. Yonnet, "Magnetomechanical devices," in *Rare-Earth iron Permanent Magnets* (J. Coey, ed.), pp. 430–451, Clarendon Press, Oxford, 1996.
- [20] E. Furlani, "Field analysis and optimization of ndfeb axial field permanent magnet motors," *IEEE Trans. Magn.*, vol. 33, pp. 3883–3885, Sept 1997.
- [21] Y. Zhilichev, "Calculation of magnetic field of tubular permanent magnet assemblies in cylindrical bipolar coordinates," *IEEE Trans. Magn.*, vol. 43, pp. 3189–3195, July 2007.
- [22] H. Rakotoarison, J. Yonnet, and B. Delinchant, "Using coulombian approach for modelling scalar potential and magnetic field of a permanent magnet with radial polarization," *IEEE Trans. Magn.*, vol. 43, pp. 1261–12–4, April 2007.
- [23] R. Ravaud, G. Lemarquand, V. Lemarquand, and C. Depollier, "The three exact components of the magnetic field created by a radially magnetized tile permanent magnet," *Progress in Electromagnetics Research, PIER* 88, pp. 307–319, 2008.
- [24] R. Ravaud, G. Lemarquand, and C. Depollier, "Analytical calculation of the magnetic field created by Permanent-Magnet rings," *IEEE Trans. Mag.*, vol. 44, no. 8, pp. 1982–1989, 2008.
- [25] R. Ravaud, G. Lemarquand, V. Lemarquand, and C. Depollier, "Discussion about the analytical calculation of the magnetic field created by permanent magnets," *Progress in Electromagnetics Research B*, vol. 11, pp. 281–297, 2009.
- [26] R. Ravaud, G. Lemarquand, and T. Roussel, "Time-varying non linear modeling of electrodynamic loudspeakers," *Applied Acoustics*, vol. 70, no. 3, pp. 450–458, 2009.
- [27] W. Klippel, "Tutorial: Loudspeaker nonlinearities - causes, parameters, symptoms," *J. Audio Eng. Soc.*, vol. 54, pp. 907–939, Oct. 2006.
- [28] W. Klippel, "Speaker auralization subjective evaluation of nonlinear distortion," presented at the AES 110th Convention, May 2001.
- [29] W. Klippel, "Prediction of speaker performance at high amplitudes," presented at the AES 111th Convention, Nov.30-Dec.3rd 2001.
- [30] L. Blondel and S. Elliott, "Electropneumatic transducers as secondary actuators for active noise control part i: Theoretical analysis," *Journal of Sound and Vibration*, vol. 219, pp. 405–427, 1999.
- [31] S. Lane and R. Clark, "Improving loudspeaker performance for active noise control applications," *J. Audio Eng. Soc.*, vol. 46, pp. 508–519, 1998.
- [32] G. Hwang, H. Kim, S. Hwang, and B. Kang, "Analysis of harmonic distortion due to uneven magnetic field in a microspeaker used for mobile phones," *IEEE Trans. Mag.*, vol. 38, pp. 2376–2378, 2002.
- [33] V. Mazin and Y. Lee, "Non-uniform voice coil winding for electrodynamic loudspeaker," presented at the AES 116th Convention, May 2004.
- [34] E. Czerwinski, A. Voishvillo, S. Alexandrov, and A. Terekhov, "Multitone testing of sound system components - some results and conclusions, part 1: History and theory," *J. Audio Eng. Soc.*, vol. 49, pp. 1011–1048, Nov. 2001.

- [35] A. Voishvillo, A. Terekhov, E. Czerwinski, and S. Alexandrov, "Graphing, interpretation, and comparison of results of loudspeaker nonlinear distortion measurements," *J. Audio Eng. Soc.*, vol. 52, pp. 332–357, Apr. 2004.
- [36] W. Klippel, "Assessment of voice-coil peak displacement x_{max} ," *J. Audio Eng. Soc.*, vol. 51, pp. 307–323, May 2003.
- [37] M. T. Abuelma'atti, "Prediction of the two-tone suppression and intermodulation performance of auditory systems," *Applied Acoustics*, vol. 67, pp. 882–891, Sept. 2006.
- [38] H.C.Yu, T.Y.Lee, S.J.Wang, M.L.Lai, J.J.Ju, D.R.Huang, and S.K.Lin, "Design of a voice coil motor used in the focusing system of a digital video camera," *IEEE Trans. Magn.*, vol. 41, pp. 3979–3981, Oct 2005.
- [39] W. House, "Transducer motor assembly." US Patent 5,142,260, 1992.
- [40] Ohashi, "Magnetic circuit and speaker." Patent EP 1 553 802 A2, 2005.
- [41] J. Yonnet, G. Lemarquand, S. Hemmerlin, and E. Olivier-Rulliere, "Stacked structures of passive magnetic bearings," *J. Appl. Phys.*, vol. 70, pp. 6633–6635, November 1991.