



HAL
open science

Specific Methods for the Evaluation of Hydraulic Properties in Fractured Hard-rock Aquifers

Jean-Christophe Maréchal, Benoît Dewandel, K. Subrahmanyam, Ricardo Torri

► **To cite this version:**

Jean-Christophe Maréchal, Benoît Dewandel, K. Subrahmanyam, Ricardo Torri. Specific Methods for the Evaluation of Hydraulic Properties in Fractured Hard-rock Aquifers. *Current Science*, 2003, 85 (4), pp.511-516. hal-00462042

HAL Id: hal-00462042

<https://hal.science/hal-00462042>

Submitted on 8 Mar 2010

HAL is a multi-disciplinary open access archive for the deposit and dissemination of scientific research documents, whether they are published or not. The documents may come from teaching and research institutions in France or abroad, or from public or private research centers.

L'archive ouverte pluridisciplinaire **HAL**, est destinée au dépôt et à la diffusion de documents scientifiques de niveau recherche, publiés ou non, émanant des établissements d'enseignement et de recherche français ou étrangers, des laboratoires publics ou privés.

Specific Methods for the Evaluation of Hydraulic Properties in Fractured Hard-rock Aquifers

J.C. Maréchal^{a,*}, B. Dewandel^a, K. Subrahmanyam^b and R. Torri^a

^a BRGM, WATER Department, Unit « Water resources, Discontinuous media », Indo-French Centre for Groundwater Research, NGRI, Uppal Road, 500 007 Hyderabad, India

^b National Geophysical Research Institute, Indo-French Centre for Groundwater Research, Uppal Road, 500 007 Hyderabad, India

* Correspondence: Indo-French Centre for Groundwater Research, National Geophysical Research Institute, Uppal Road, 500 007 Hyderabad, India, Tel: + 91 40 715 80 90, Fax: + 91 40 717 15 64, marchal@ngri.res.in

Abstract:

Blocs underlined by fractures networks mainly compose hard-rock aquifers. The complexity of flows through fractures makes inadequate the use of classical techniques for the interpretation of hydraulic tests. Four different methods, well adapted to the complexity of groundwater flows in hard-rock aquifers, are presented for pumping wells and/or observation wells interpretations. The Neuman method is suited for unconfined anisotropic aquifers while Gringarten method is developed for the case of a single horizontal fracture. The third method (Warren and Root) takes into consideration the heterogeneity of the medium, allowing the introduction of a double porosity aquifer (transmissive fractures and capacitive matrix). Finally, the fourth method, Barker theory, assesses the flow dimension related to spatial distribution of conductive fractures and their connectivity. All these methods are presented and illustrated on pumping tests carried out in a granite terrain, south of Hyderabad, India.

Keywords: hydrogeology, hydraulic test, hard-rock, anisotropy, heterogeneity

INTRODUCTION

Large tracts of South India are underlain by hard crystalline rock terrain (granite, gneiss, basalt...). The area also is classified as semiarid to arid, generally prone to drought conditions, requiring optimal management of groundwater resources against increasing demands of water for various activities (agricultural, industrial, domestic). Estimating the hydraulic characters of water bearing layers is an essential part of groundwater studies. The most effective way of determining these characteristics is to conduct and analyse in-situ hydraulic tests. One of the early records of pumping tests on a large scale in India was done by Vincent and Sharma (1). The study indicates that well losses comprise a significant portion of the total drawdown in a number of low- and high-yielding wells. Karanth and Prakash (2) observed that the transmissivity values (T) obtained by slug-tests are more than pump test values for low T values, and that they vary from negligible up to a factor of about three for higher T values. Pradeep Raj et al. (3) from hydrological tests on dug wells in the crystalline rocks, estimated a range of T values from 26.5 to 56.36 m²/d, for the weathered zone based on interpretation made by Papodopulos and Cooper method (4). Ballukraya (5) from a study in Karnataka postulates that the yield fluctuation in the pre- and post-monsoon periods is largely dependent on recharge that is restricted to about 60m depth. All these studies considered hard-rock aquifer as isotropic and homogeneous, which is not the case as demonstrated below.

The fresh unaltered massive hard rock is not water bearing, but the (i) weathered zone and (ii) fissured and jointed zones are productive. In general, the weathered horizon, when it is water saturated, is poorly transmissive with high storage while the fissured and jointed zones are poorly capacitive, but highly transmissive. The problem of flow through fractures or a fractured environment is primarily a problem of flow through a dual-porosity media, which

includes the porous matrix and the fractured network. These two components are hydraulically interconnected and cannot be treated separately. The degree of interconnection between these two media defines the character of the entire flow domain, and is a function of the hydraulic properties of each of them. These properties include matrix hydraulic conductivity and fracture-network distribution, orientation, apertures, connectivity and thus, bulk hydraulic conductivity. They will also determine the heterogeneity and anisotropy of the whole aquifer. The complexity of flows through fractures makes inadequate the use of classical techniques such as Theis and Jacob methods for the interpretation of hydraulic tests. Basically, in hard rock context, assumptions (homogeneity and isotropy) attached to such methods are not coherent with the reality. Thus, there is a need for alternative techniques for the evaluation of aquifer parameters able to involve the specificity of hard-rock aquifers.

Four different methods are presented below, for the interpretation of pumping tests, well adapted to the complexity of groundwater flows in hard-rock aquifers. The method of Neuman (6) is suited for unconfined anisotropic aquifers while Gringarten method (7) was developed for the case of a single (horizontal) fracture intersecting the pumping well. These methods are complementary because dealing both with anisotropy at the observation and at pumping wells respectively. The Warren and Root (8) method takes into consideration the heterogeneity of the medium, allowing the introduction of a double porosity aquifer (transmissive fractures and capacitive matrix). Finally, the fourth method – Barker theory (9) – opens the way for the assessment of the flow dimension and of the degree of connectivity between the fractures. All these methods are incorporated and illustrated on observations obtained from pumping tests carried out in the same study area.

The Maheshwaram watershed located in India (Andhra Pradesh, Ranga Reddy District) is the main study area of the Indo-French Centre for Groundwater Research (French Geological Survey / National Geophysical Research Institute). This watershed, located at 30 kilometres away from Hyderabad, covers a surface of about 55 km² and is mainly constituted by Archean granites. The weathering profiles are observable through many dugwells earlier used by the farmers for irrigation. Profiles are generally truncated by erosion: under a few decimetres of red soils, the alterites are thick with less than 5 meters. A high density of horizontal fractures is observed in the fissured zone (10). Vertical fractures with a tectonic origin are also present. Due to the overexploitation of groundwater resources, water levels are far below ground level and the alterites are dry while only the fissured zone is saturated. This specificity was used to realise pumping tests with the objective to test the four interpretation methods mentioned above and thus to characterise the hydrodynamic properties of the fissured layer only.

ANISOTROPY OF PERMEABILITY USING NEUMAN METHOD AT OBSERVATION WELLS

For instance, on a bi-logarithmic plot (Figure 1), the drawdown curves at observation wells IFP-1/1 and IFP-1/2 during pumping tests at IFP-1 well have a complex shape, difficult to interpret with classical methods (Theis for example). Drawdown curves are composed by three parts: the first one, at short times, with strong slopes, is followed by an intermediate period during which water level stabilisation occurs; a third part for long times shows a new increase in slopes.

The theory initially developed by Boulton (11) to interpret some special curves obtained in observation wells takes into account the notion of « delayed yield from storage in unconfined aquifers » (12). It was improved by Neuman (6, 13) who developed an analytical solution adapted to anisotropic unconfined aquifers, where K_r is the radial permeability parallel to the aquifer extension and K_z is the vertical permeability. Neuman method considers an

unconfined and infinite aquifer. When a constant discharge rate is pumped in a complete well, the water comes for one part from the storage in the aquifer and for the other part from gravitational drainage at the free surface. The Neuman solution, under abacus, gives reduced drawdowns in an observation well located at a radial distance r from the pumping well,

$$s_{DN} = \frac{4\pi T}{Q} \text{ as a function of :}$$

- Reduced time $t_s = \frac{Tt}{Sr^2}$ for type A curves;
- Reduced time $t_y = \frac{Tt}{S_y r^2}$ for type B curves;

where T is the transmissivity of the aquifer, S the storage coefficient, S_y the specific yield, t the time since the starting of pumping. The interpretation using this method consists in fitting the observed drawdowns on the abacus constituted by two types of curves: type A curve for short times and type B curve for late times. Both curves are characterised by the same parameter $\beta = \frac{r^2 K_D}{b^2}$, which is a function of the permeability anisotropy $K_D = \frac{K_z}{K_r}$, the

thickness of the aquifer b and the distance r between the observation and pumping wells.

The application of this method (Table 1a) to the observation wells IFP-1/1 and IFP-1/2 leads to the evaluation of transmissivities, storage coefficients (S) and specific yields (S_y). Very similar values are obtained in each observation wells for T_A and T_B showing the coherence of the interpretation of this pumping test using Neuman method. The values obtained for specific yields are consistent with other ones deduced both from indirect methods by Magnetic Resonance soundings (14) and from direct methods by adjustment of water levels fluctuations using a global model (15).

The determination of K_D needs the knowledge of the aquifer thickness b . Flowmeter measurements during injection tests in eight wells of the basin have shown that the fresh basement does not contain any conductive fracture. It is namely the case in pumping well IFP-1. Thus, the top of this layer was chosen as the bottom of the aquifer. As for classical methods, the uncertainty on the value of r makes difficult any interpretation of drawdown in pumping wells. The results of this interpretation, included in Table 1b, show an anisotropy of the permeability tensor, in accordance with geological observations: horizontal permeability is systematically higher than vertical one. This result is consistent with the observation of many horizontal fractures in dugwells.

HORIZONTAL FRACTURE INTERSECTING THE PUMPING WELL USING GRINGARTEN METHOD

Flowmeter vertical profile in IFP-9 (10) shows that only one fracture is conductive (at 29 meters depth) and is saturated during the whole pumping test. Moreover, the analysis by Neuman method arises the existence of hydraulic anisotropy due to the existence of horizontal fractures (10). Thus, the method developed by Gringarten and Ramey (16) for a vertical well intersecting a single horizontal fracture in an anisotropic aquifer (Figure 2), applicable to the pumping well, is well adapted to the hydrogeological context of IFP-9 well.

The complexity of the analytical solution necessitates an interpretation through the adjustment of observed drawdowns on theoretical curves of an abacus (7) giving the reduced drawdowns in a pumping well as a function of reduced time for various geometrical configurations

represented by the parameter H_{DG} , when the fracture is located at the centre of the aquifer

$$(z_f/H = 0.5), \text{ with } t_{DG} = \frac{K_r t}{S_s r_f^2}, s_{DG} = \frac{4\pi\sqrt{K_r K_z} r_f s}{Q} \text{ and } H_{DG} = \frac{H}{r_f} \sqrt{\frac{K_r}{K_z}},$$

where z_f is the distance between the fracture and the bottom of the aquifer, H the aquifer thickness. K_r , the permeability along the radial direction parallel to the fracture, can be interpreted as the permeability increased by the existence of the horizontal fracture. K_z , the vertical permeability, represents the matrix permeability, S_s the specific storage coefficient, t the time since the pumping starting, r_f the radius of the horizontal fracture, s the drawdown and Q the pumping discharge rate.

Adjustment of observed drawdowns by Gringarten theoretical curves (Figure 3) leads to high value of H_{DG} , suggesting a high permeability anisotropy. Difference between observations and theoretical curve at short times is attributed to well losses in the pumping well. Knowing the geometry of the case (i.e. the thickness H of the aquifer), supposing the distance z_f between the bottom of the aquifer and the fracture equal to $0.5*H$ and using the value determined by Maréchal et al. (10) using Neuman method for S_s ($9.7 \cdot 10^{-5}$ at IFP-9), the hydrodynamic properties of the aquifer are evaluated (Table 2): K_r the horizontal permeability, K_z the vertical permeability and the radius r_f of the horizontal fracture. It is observed that the anisotropy of the aquifer is shown in the pumping wells while estimated fracture radius is coherent with field observations.

DOUBLE POROSITY MODEL USING WARREN AND ROOT METHOD

Due to the fact that blocs separated by fractures compose hard-rock aquifers, one method allowing describing such behaviour is proposed. This method derives from the conceptual double porosity model developed by Barenblatt et al. (17). The concept (Figure 4) supposes a confined aquifer constituted by two media: the fractures, transmissive but poorly capacitive, and the matrix capacitive but poorly transmissive. Each medium is characterised by its hydraulic properties: K_f and S_f are the permeability and the storage coefficient of the fracture medium respectively and K_m and S_m are the permeability and the storage coefficient of the matrix respectively. The flow, radial to the pumping well is only controlled by the transmissivity of fractures (flow from matrix to pumping well is nil, $K_f \gg K_m$) and the fractures network drains the matrix where the flow is stationary (spatial variation of the hydraulic head is neglected). The expression of the drawdown is: $s(r,t) = \frac{Q}{4\pi T_f} F(u^*, \lambda, \omega)$;

$$u^* = \frac{T_f t}{(S_f + \beta S_m) r^2}, \lambda = \alpha r^2 \frac{K_m}{K_f} \text{ and } \omega = \frac{S_f}{S_f + \beta S_m}$$

where λ is interporosity flow coefficient (dimensionless), $\alpha = 4n(n+2)/l^2$ shape factor, parameter characteristic of the geometry of the fractures and aquifer matrix where n (dimensionless) is the number of fracture sets ($n = 1, 2, 3$; see Figure 4), l the width of matrix blocs (in meter), β , a factor, for early time analysis equal to 0 and for late time analysis equal to $1/3$ (orthogonal system, $n=2, 3$) or 1 ($n=1$), r a radial distance from the pumping well, T_f the fractures transmissivity ($T_f = H K_f$; H : aquifer thickness), Q the pumping rate and t the time.

This method is well illustrated at pumping well IFP-16. The logarithmic derivatives of drawdowns in IFP-16 have the typical shape of a double porosity aquifer (Figure 5a): (i) well effects and flow trough fractures to pumping well, (ii) transitional period: the ‘‘U’’ illustrates

the contribution of the matrix flow through fractures to the pumping (note that in most case the “U” of derivatives is often masked by well effects) and (iii) flow in fractures and matrix. The application of Warren and Root method is then justified for this data set (Figure 5b). For the interpretation, according to flowmeter measurements and geological observations, $n=3$ and $l=1$ m were used. The hydraulic conductivity of fracture network $K_f = 5,3.10^{-5}$ m/s and that one of matrix $K_m = 7,76.10^{-8}$ m/s. On figure 5b is also presented the interpretation using Theis method, which cannot properly interpret the drawdown after 470 min of pumping. This shows the limit of such models for hydraulic tests in hard-rock terrain, and consequently the necessity to use more sophisticated models.

CONNECTIVITY AND FRACTIONAL DIMENSION FLOW USING BARKER THEORY

In fractured aquifer, flow properties are controlled by the fractures distribution. Barker model (9) takes account of the dimension of the flow, which results from the distribution and connectivity of the conductive fractures (Figure 6). This theory is a generalisation of the Theis theory considering a radial flow, n -dimensional, into a homogeneous, confined and isotropic fractured medium characterised by a hydraulic conductivity K_f and specific storage S_{sf} . This Generalised Flow Model introduces the fractional dimension of flow, n , which characterises the variation law of flow section according to distance from the pumping well. Values of n vary from 0 to 3, when $n=3$ the flow is spherical (Figure 6), cylindrical when $n=2$ (that corresponds to Theis model) and linear when $n=1$. Parameter n can take any values, entire or not, revealing the complex geometry of the flow. Expression of transient drawdown in the aquifer ($s(r,t)$) is given as following:

$$s(r,t) = \frac{Q r^{2-n}}{4\pi^{\frac{n}{2}} K_f b^{3-n}} \Gamma\left(\frac{n}{2} - 1, u\right), \quad u = \frac{S_{sf} r^2}{4 K_f t}$$

where $\Gamma(a, x) = \int_x^{\infty} e^{-t} t^{a-1} dt$ is the incomplete gamma function, r the radial distance from the pumping well, Q the pumping rate and t the time.

This method has been applied to pumping well IFP-9 (Figure 7). The generalised transmissivity $K_f b^{3-n}$ is evaluated: $1.66 \cdot 10^{-4} \text{ m}^{1.5}/\text{s}$. The flow dimension is equal to 2.5, and thus corresponds to an intermediate flow between cylindrical (like Theis) and spherical. The flow seems to be generated by one sub-horizontal fractures network, or only one single horizontal fracture as suggested by flowmeter tests, connected to a second fracture network probably sub-vertical to vertical.

CONCLUSIONS

Aquifer tests in hard-rock terrain (granite, gneiss, basalt) make inadequate the use of classical techniques such as Theis or Jacob methods and need specific methods allowing taking into account the complexity of groundwater flow. The methods adopted in the present paper consider the heterogeneity and the anisotropy of the media: anisotropy of permeability (6), single horizontal fracture intersecting the pumping well (7), double porosity behaviour (8) or connectivity and fractional dimension flow (9). These methods are successfully applied to case studies in Archean granites and allow to characterise the complexity of flows through

fractures. These techniques should be widely used by scientists and engineers for fractured aquifer characterisation (structure, anisotropy, heterogeneity) and evaluation (permeability, storage, water supply...).

References

1. Vincent W. Uhl, Jr and Sharma, G.K., *Groundwater*, 1978, **16(3)**,192-203.
2. Karanth, K. R. and Prakash, V.S., *Journal of the Geological Society of India*, 32, 1988, 244-248.
3. Pradeep Raj, Nandulal, L. and Soni, G.K., *Journal of the Geological Society of India*, 1996, **48**, 299-307.
4. Papadopoulos, I.S. and Cooper, H.H., *Water Resources Research*, 1967, 241-244.
5. Ballukraya, P.N., *Journal of the Geological Society of India*, 1997, **50**, 277-282.
6. Neuman, S.P., *Water Resources Research*, 1975, **11/2**, 329-342.
7. Gringarten, A.C. and Witherspoon, P.A., *Percolation through fissured rock*, Deutsche Gesellschaft fur Red and Grundbau, Stuttgart, 1972, T3B1-T3B8.
8. Warren, J.E. and Root, P.J., *Engineering Journal*, 1963, **3**, 245-255.
9. Barker, J.A., *Water Resources Research*, 1988, **24**, 1796-1804.
10. Maréchal, J.C., Wyns, R., Lachassagne, P., Subrahmanyam, K., *Journal of the Geological Society of India*, submitted.
11. Boulton, N.S., *J. Hydrol.*, 1970, **10**, 369-378.
12. Boulton, N.S. and Pontin, J.M.A., *J. Hydrol.*, 1971, 14, 53-65.
13. Neuman, S.P., *Water Resources Research*, 1972, **8/4**, 1031-1045.
14. Wyns, R., Baltassat, J.M., Lachassagne, P., Legchenko, A., Vairon, J., Mathieu, F., *Bull. Soc. géol. France*, to be published.
15. Engerrand, C., PhD Thesis University Paris VI, 2002.
16. Gringarten, A.C. and Ramey, H.J., *Trans. Am. Inst. Min. Eng.*, 1974, **257**, 413-426.
17. Barenblatt, G.E., Zheltov, I.P. and Kochina, I.N., *Journal of Applied Mathematic Mechanic Transl.*, 1960, **24/10**, 1796-1804.
18. Black, J.H. *Applied Hydrogeology*, 1994, **3**, 56-70.

Acknowledgements: This work has been achieved by the scientists belonging to the Indo-French Centre for Groundwater Research (BRGM-NGRI). The authors thank the French Ministry of External Affairs and the Service of Cooperation and Cultural Action of the French Embassy in New Delhi, which has supported exchanges of scientists between France and India. The Indo-French Centre for Groundwater Research received also a funding from CNRS (French National Centre for Scientific Research) in the ACI Program « Water and Environment ».

Figures

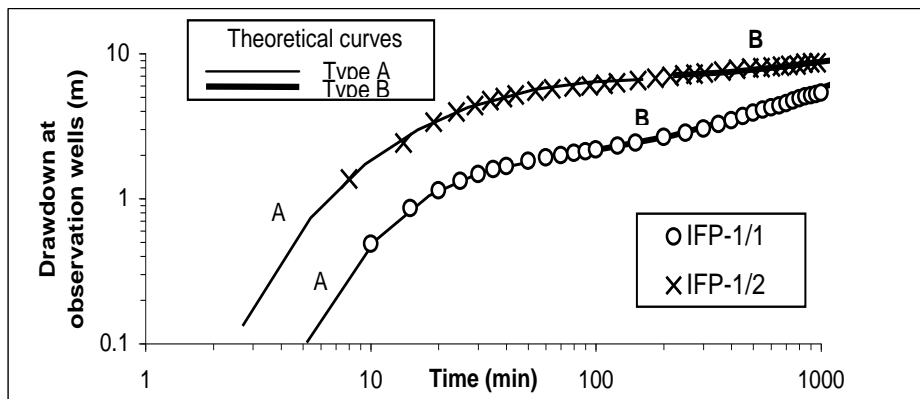

Figure 1 : Adjustment of drawdown in observation wells IFP-1/1 and IFP-1/2 using Neuman theoretical curves of types A and B.

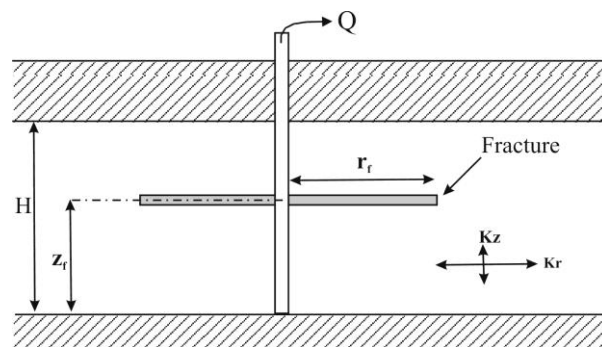

Figure 2: Schematic section of the Gringarten aquifer model (one single horizontal fracture).

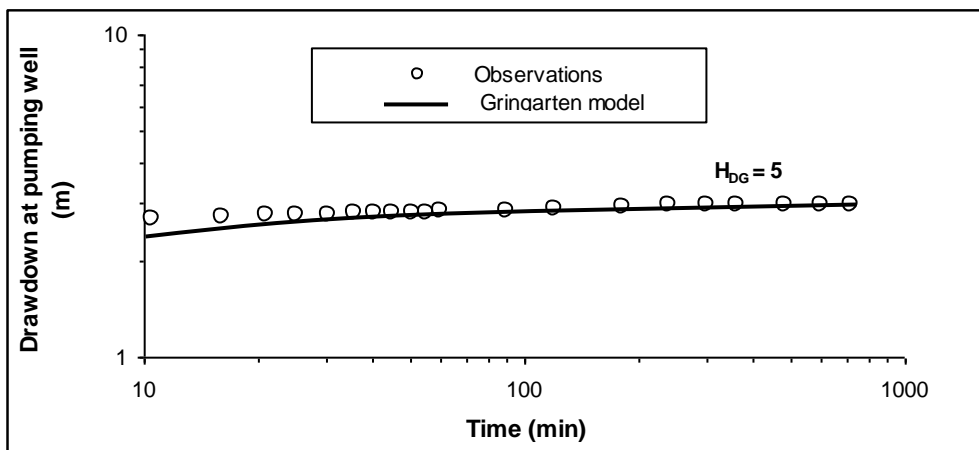

Figure 3: Adjustment of drawdown in pumping well IFP-9 using Gringarten theoretical curves.

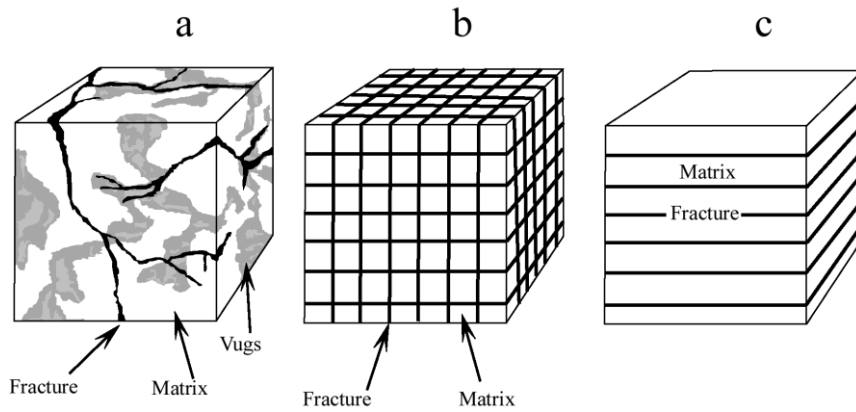

Figure 4: Double porosity model. (a): naturally fractured rock formation, (b) and (c) Warren and Root idealised fractured system; (b) orthogonal fractures network ($n=3$) and (c) horizontal fractures network ($n=1$).

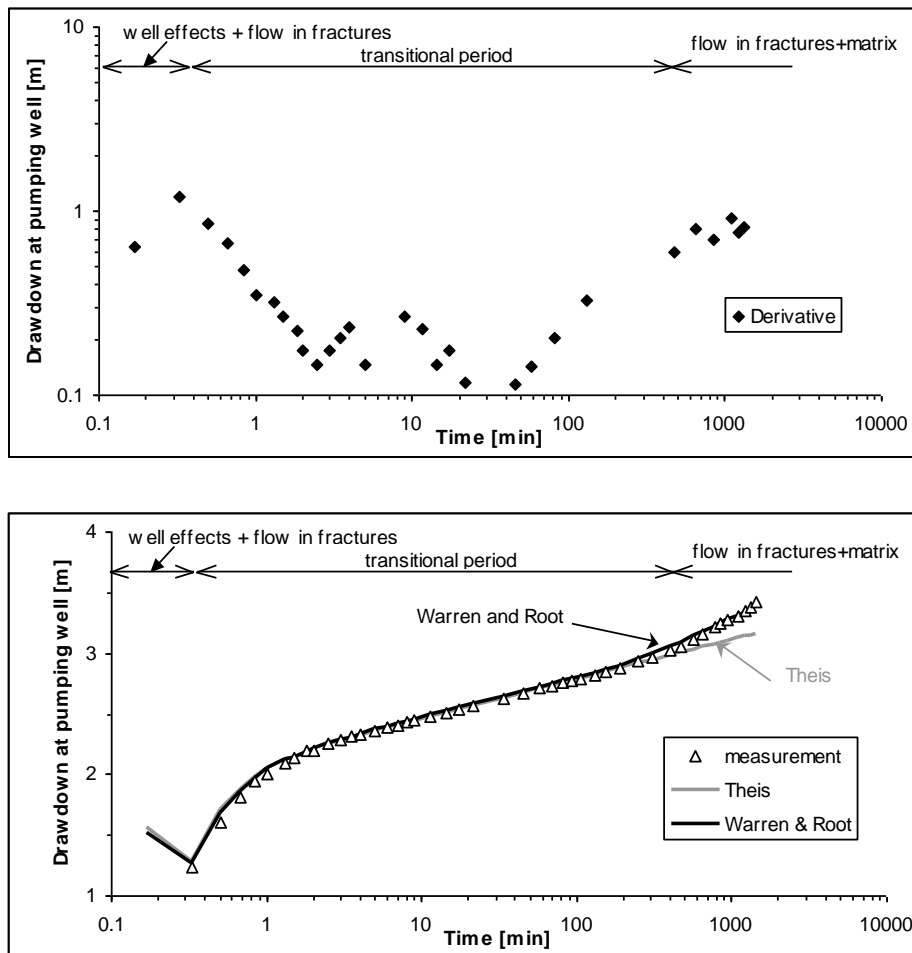

Figure 5: Interpretation at pumping well IFP-16 using a double porosity model. (a) logarithmic derivative at IFP-16 and (b) adjustment of drawdown using Warren and Root (double porosity) and Theis method.

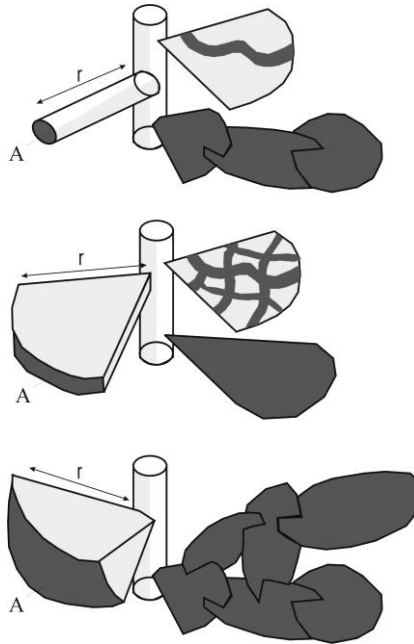

Figure 6: The concept of flow dimension (from (18)).

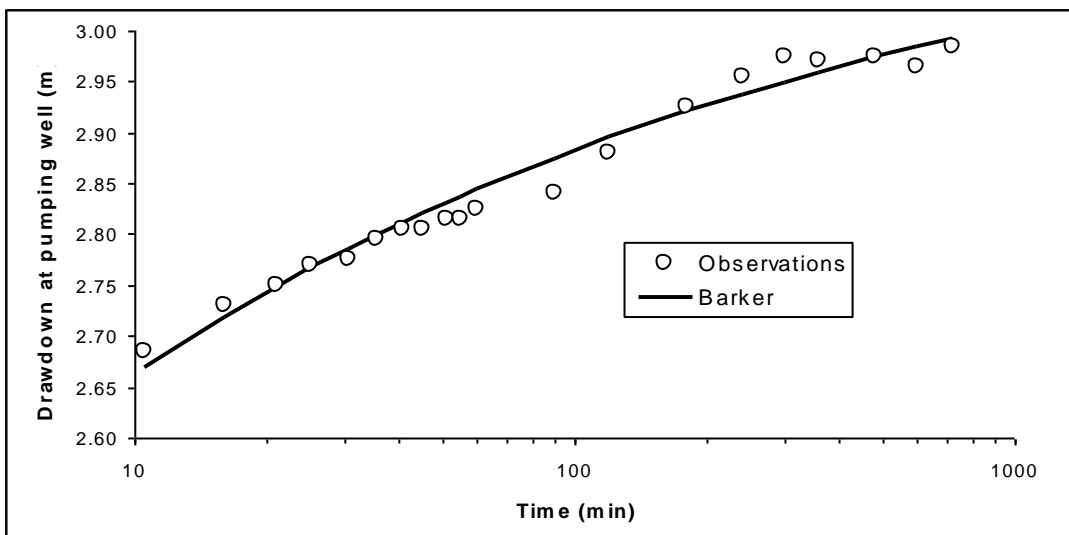

Figure 7: Adjustment of drawdown at pumping well IFP-9 using Barker theory.

Tables

Observation well	Pumping well	r (m)	T_A (m ² /s)	T_B (m ² /s)	T_A/T_B (-)	T_{AB} (m ² /s)	S (-)	S_y (-)
IFP-1/1	IFP-1	28	1.76E-05	1.96 ^E -05	0.90	1.86E-05	7.0E-05	1.7E-03
IFP-1/2	IFP-1	27.5	1.71E-05	1.76 ^E -05	0.97	1.74E-05	3.7E-05	1.5E-03

Table 1a : transmissivity and storage parameters obtained by adjustment of drawdown (T_A : transmissivity obtained by adjustment on type A curve, T_B : transmissivity obtained by adjustment on type B curve, T_{AB} : average of T_A and T_B).

Observation well	β (-)	r (m)	b (m)	K_r (m/s)	K_z (m/s)	K_D (-)	$1/K_D$ (-)
IFP-1/1	1.00	28	21.8	8.5E-07	5.2E-07	0.606	1.7
IFP-1/2	0.20	27.5	21.8	8.0E-07	1.0E-07	0.126	8.0

Table 1b : permeability and anisotropy degree determined at observation wells using Neuman method

Pumping Well	Known parameters					Parameters determined by adjustment				
	H (m)	<i>Fissure</i>	z_f (m)	z_f/H (-)	S_s^* (1/m)	H_{DG} (-)	r_f (m)	K_r (m/s)	K_z (m/s)	K_r/K_z (-)
IFP-9	7.3	F9/1	4.0	0.55	9.7E-05	5	3.4	2.9E-05	5.2E-06	5.5

Table 2 : permeability, anisotropy degree and radius of the horizontal fracture determined at pumping wells using Gringarten method (* : S_s is the average of specific storage coefficient determined for each site using Neuman method at observation wells).