



How form errors impact on 2D precision assembly?

ADRAGNA Pierre-Antoine,
Université de Technologie de Troyes
SAMPER Serge, FAVRELIERE Hugues,
Université de Savoie

IPAS 2010, Chamonix, France, 14-17 February 2010



Mechanical assemblies:

- stack up of part,
- assemblies with clearances

Theoretical assembly: stack up

Assumptions

- Rigid parts
- No clearance
- Positioning force

Theoretical assembly: stack up

Assumptions

- Rigid parts
- No clearance
- Positioning force

→ No form deviations

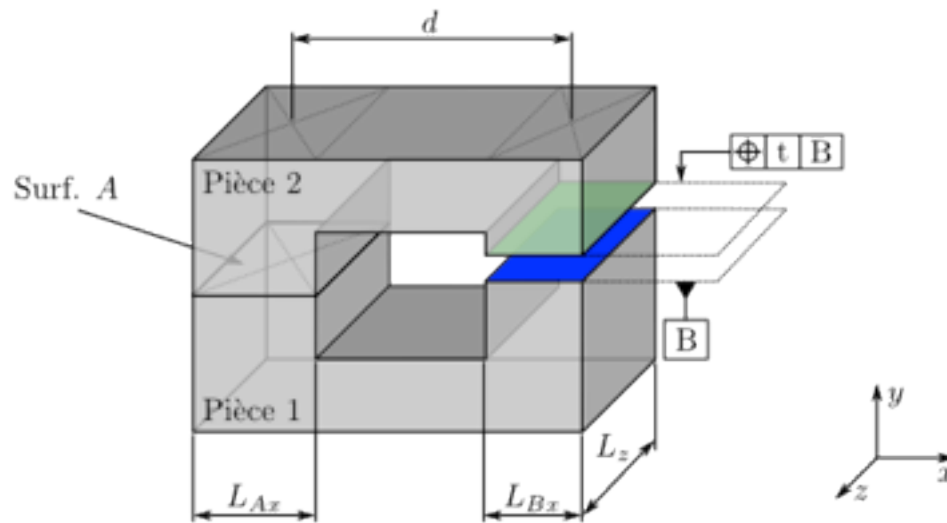

$$L_{Ax} = 40 \text{ mm}$$

$$L_{Bx} = 20 \text{ mm}$$

$$L_z = 40 \text{ mm}$$

Theoretical assembly: stack up

Assumptions

- Rigid parts
- No clearance
- Positioning force

→ No form deviations

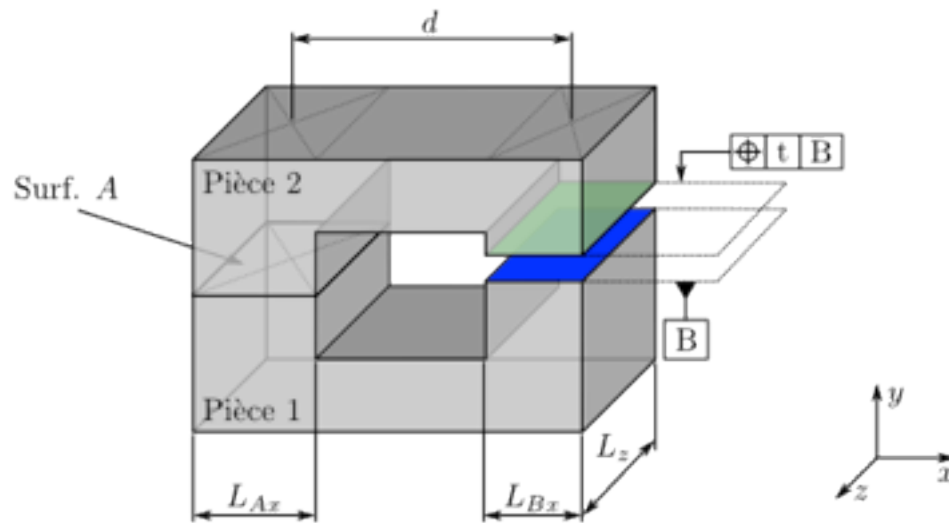

$$\begin{aligned}L_{Ax} &= 40 \text{ mm} \\L_{Bx} &= 20 \text{ mm} \\L_z &= 40 \text{ mm}\end{aligned}$$

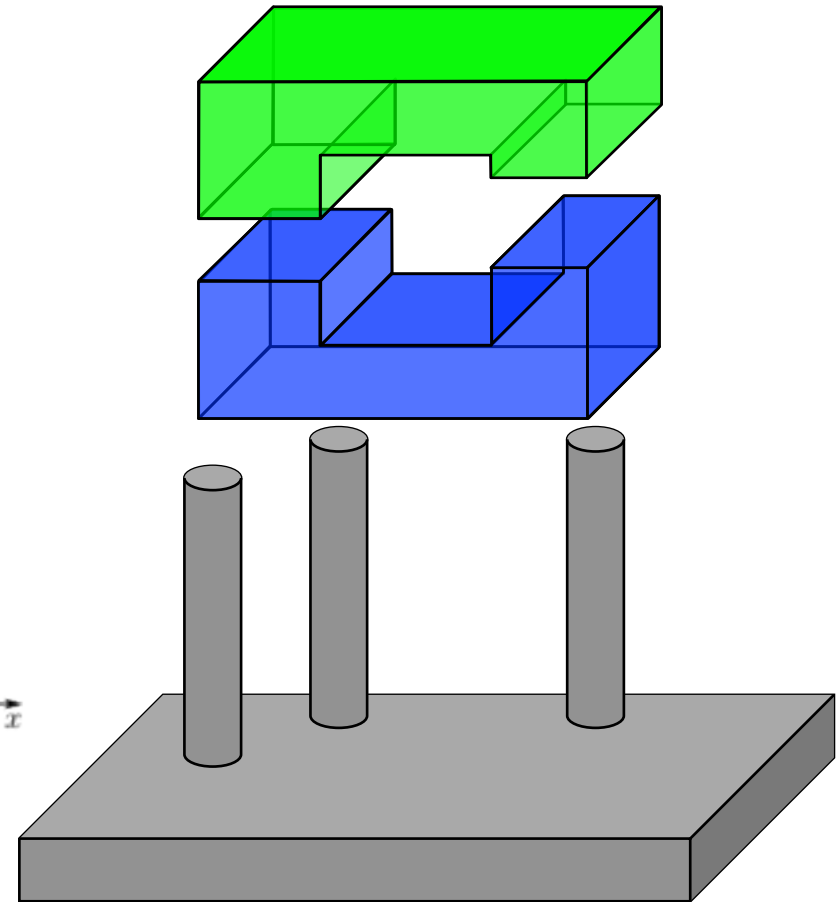

Theoretical assembly: stack up

Assumptions

- Rigid parts
- No clearance
- Positioning force

→ No form deviations

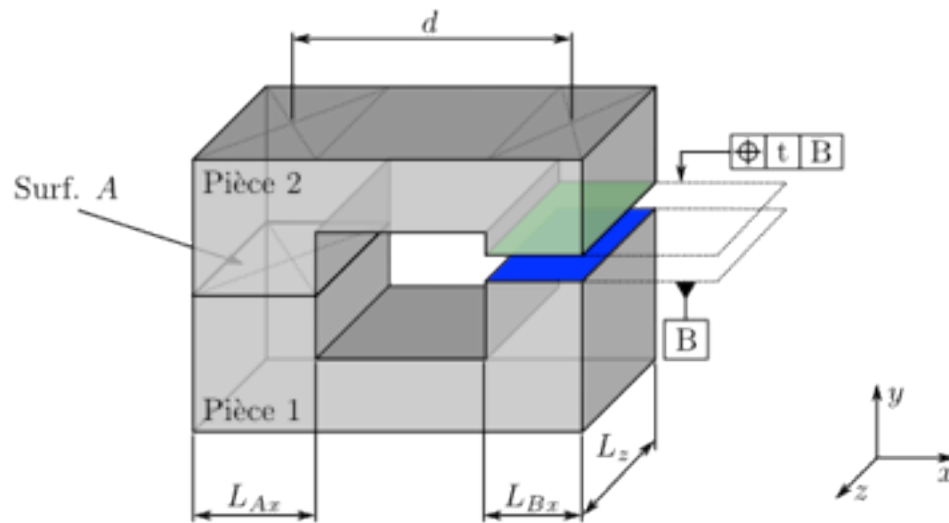

$$\begin{aligned} L_{Ax} &= 40 \text{ mm} \\ L_{Bx} &= 20 \text{ mm} \\ L_z &= 40 \text{ mm} \end{aligned}$$

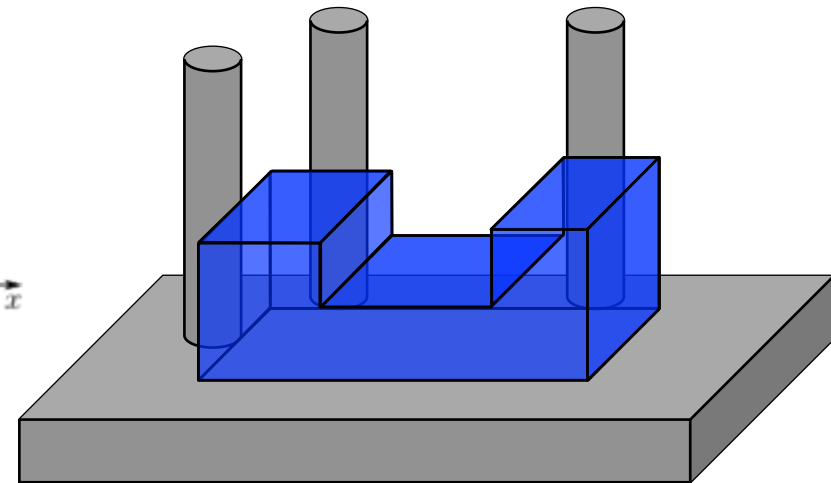
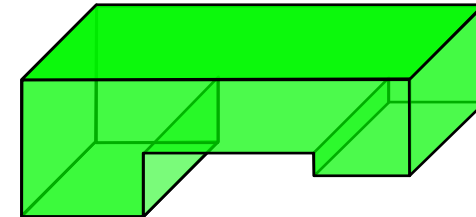

Theoretical assembly: stack up

Assumptions

- Rigid parts
- No clearance
- Positioning force

→ No form deviations

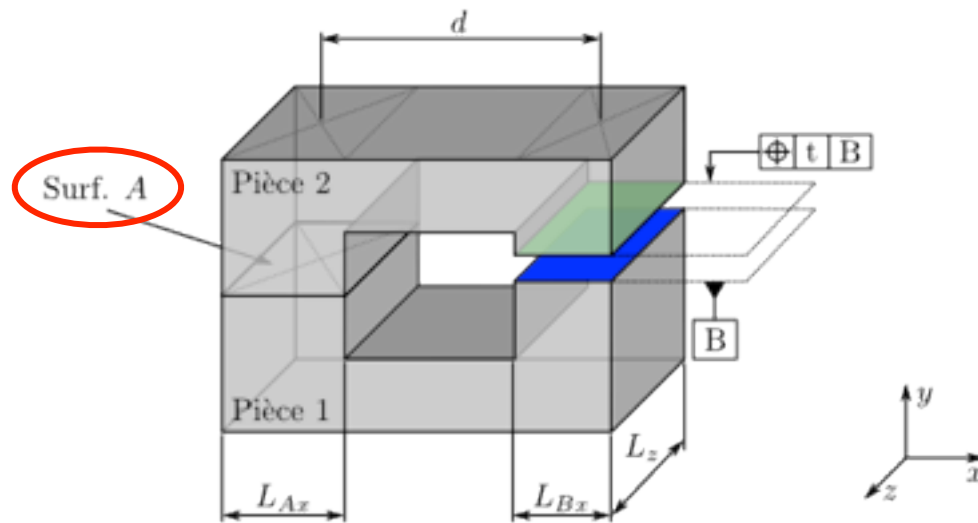

$$\begin{aligned}L_{Ax} &= 40 \text{ mm} \\L_{Bx} &= 20 \text{ mm} \\L_z &= 40 \text{ mm}\end{aligned}$$

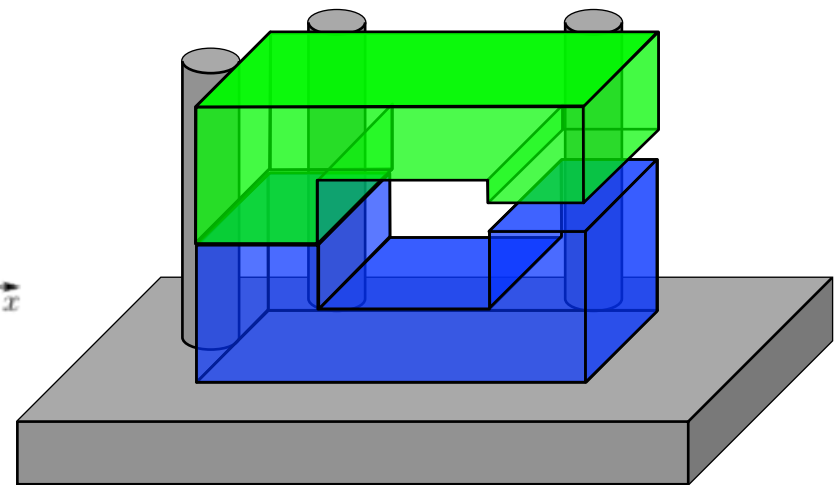

Theoretical assembly: stack up

Assumptions

- Rigid parts
- No clearance
- Positioning force

→ No form deviations

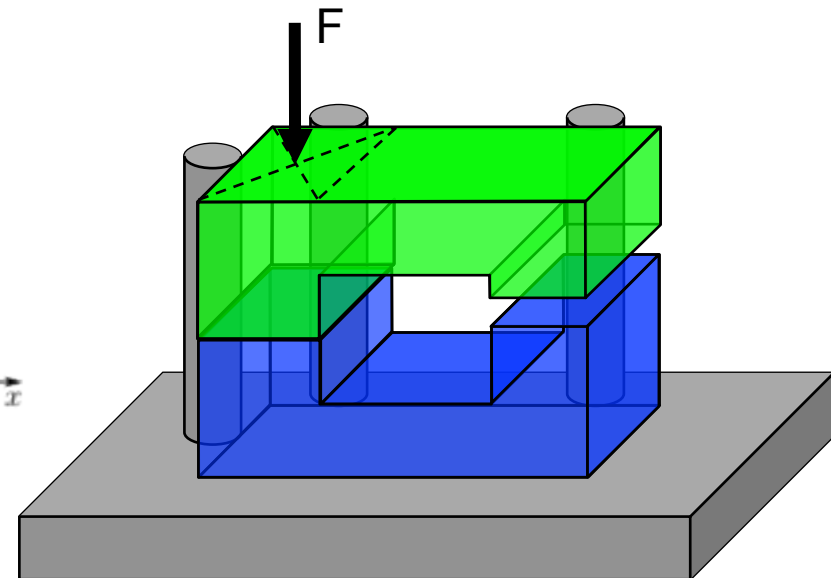
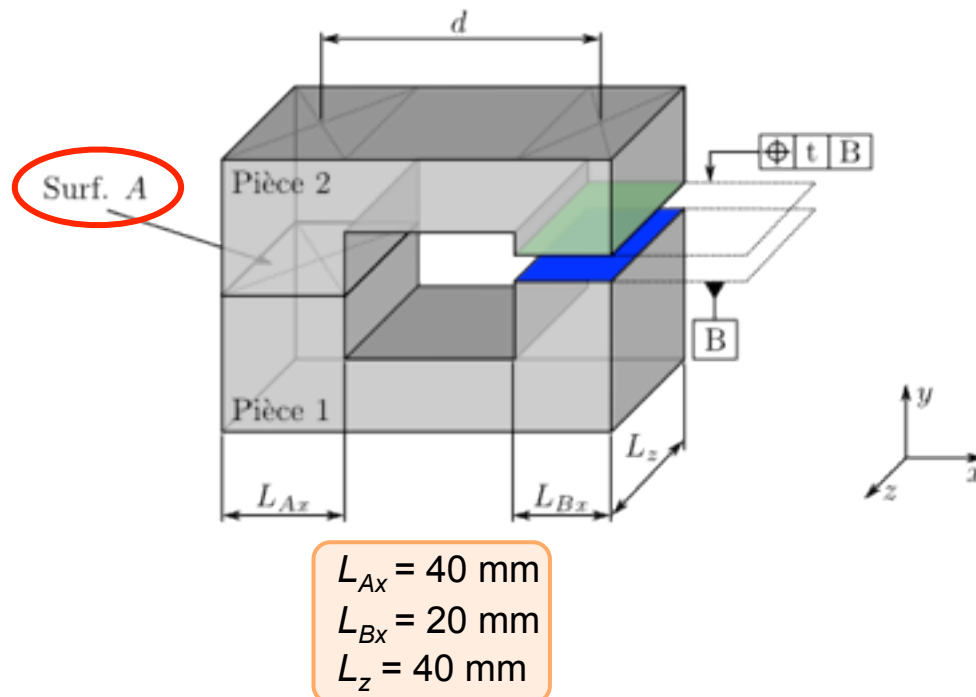

Theoretical assembly: stack up

Assumptions

- Rigid parts
- No clearance
- Positioning force

→ No form deviations

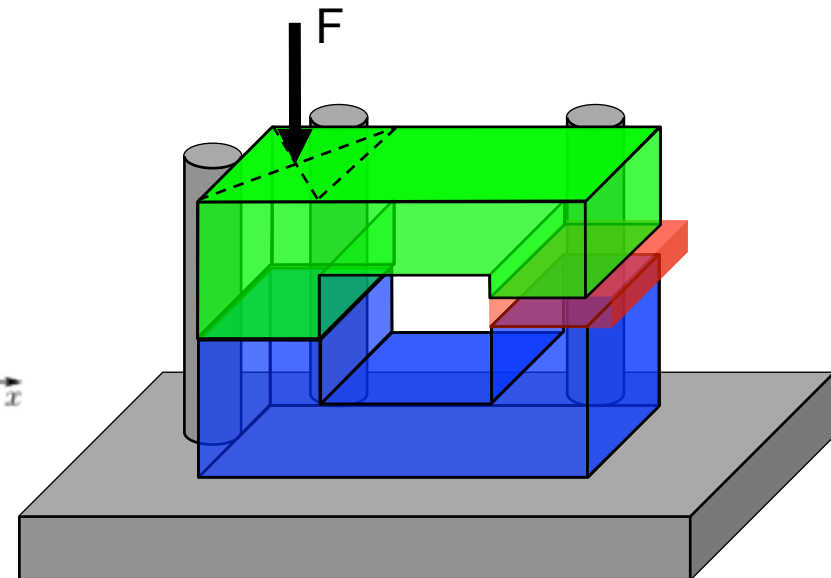
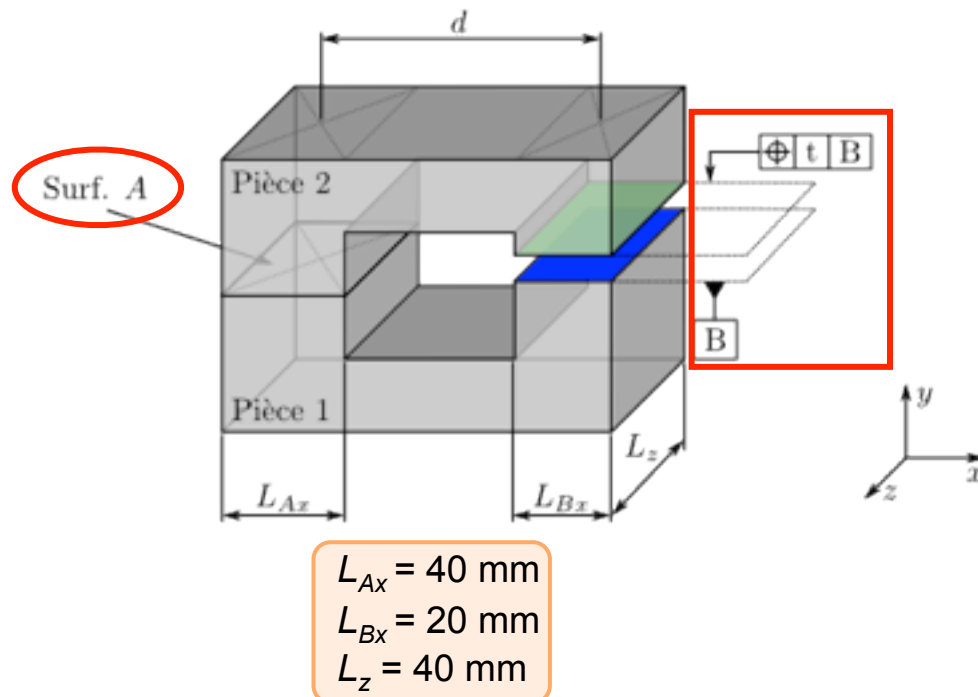

Theoretical assembly: clearance

Assumptions

- Rigid parts
- Clearance

Theoretical assembly: clearance

Assumptions

- Rigid parts
- Clearance

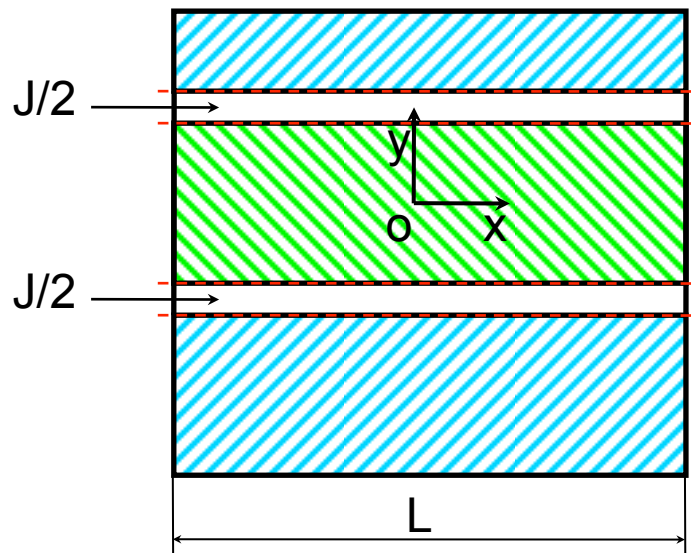

Theoretical assembly: clearance

Assumptions

- Rigid parts
- Clearance

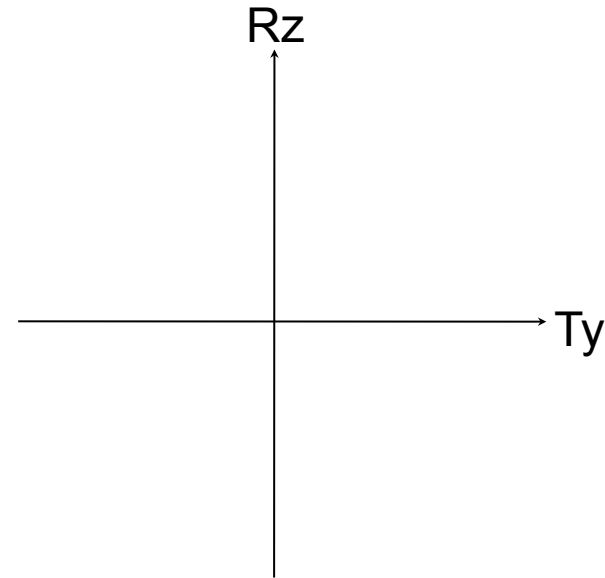
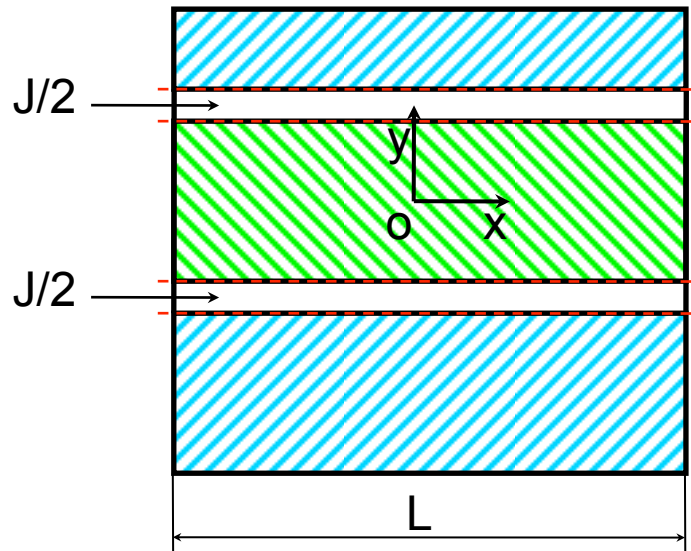

Theoretical assembly: clearance

Assumptions

- Rigid parts
- Clearance

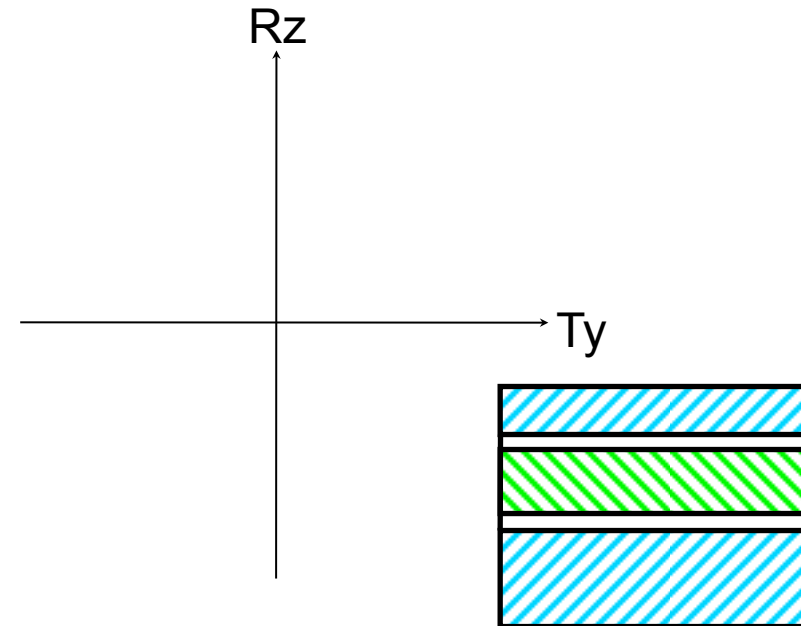
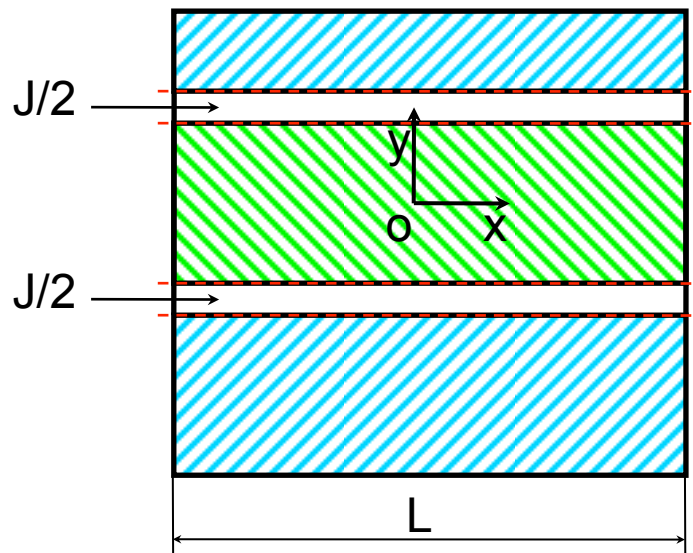

Theoretical assembly: clearance

Assumptions

- Rigid parts
- Clearance

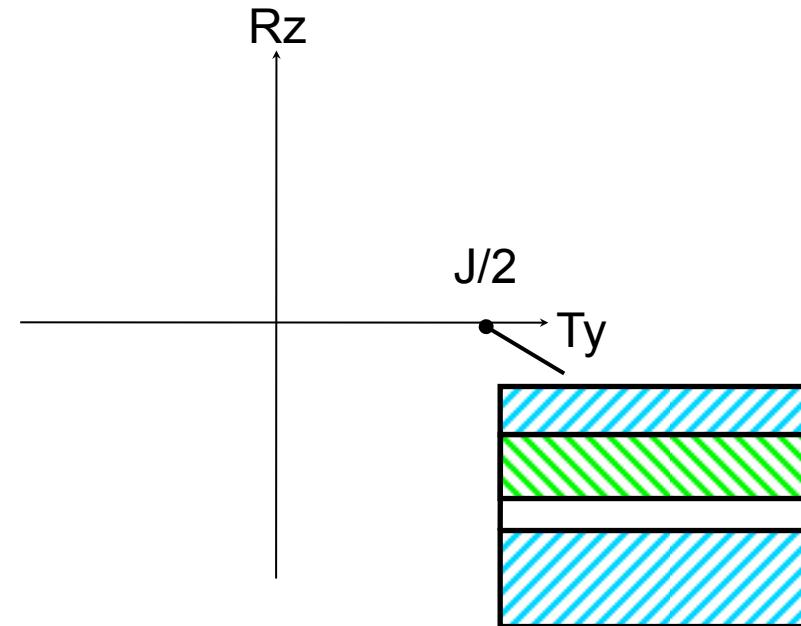
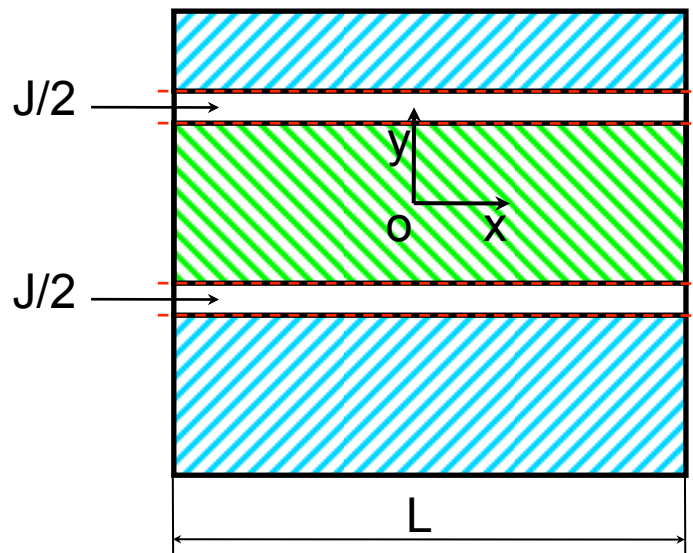

Theoretical assembly: clearance

Assumptions

- Rigid parts
- Clearance

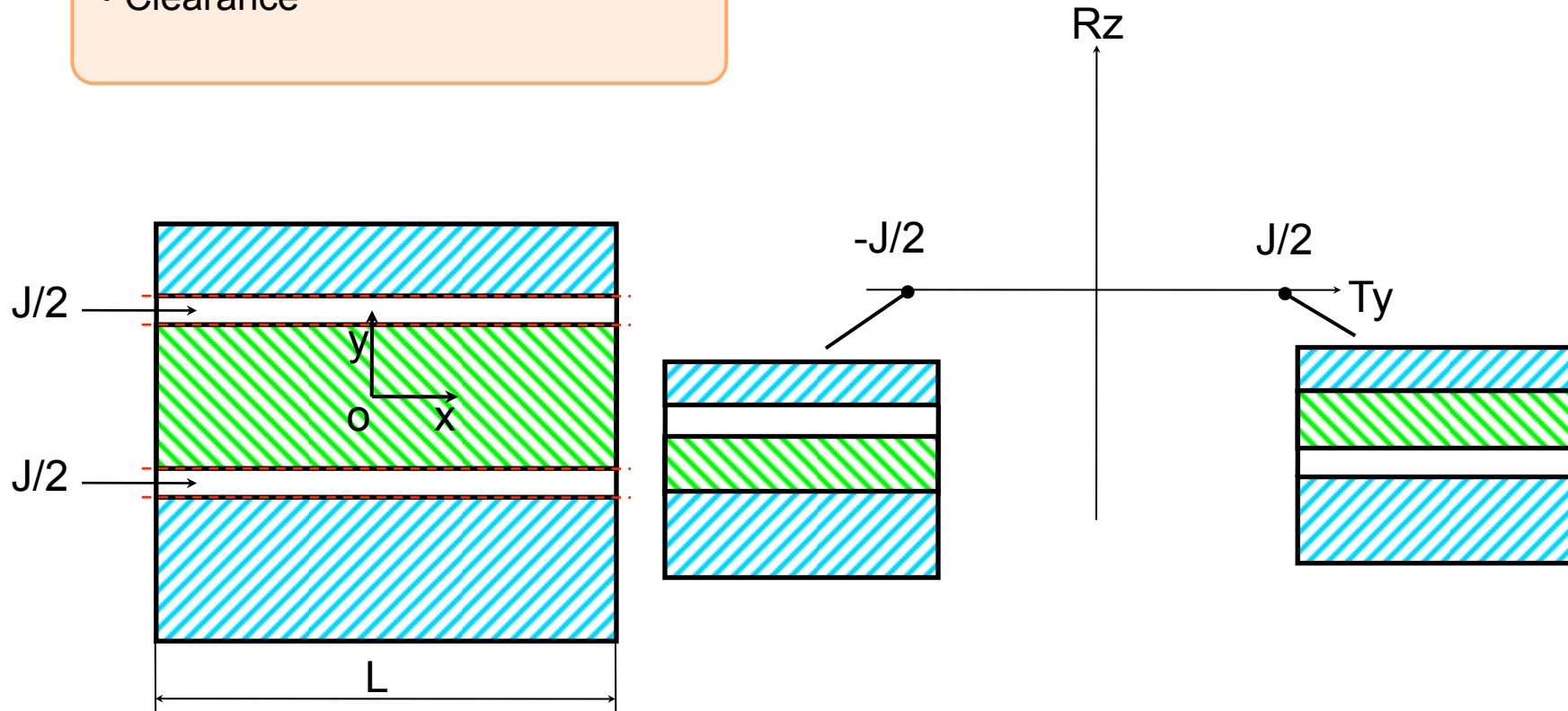

Theoretical assembly: clearance

Assumptions

- Rigid parts
- Clearance

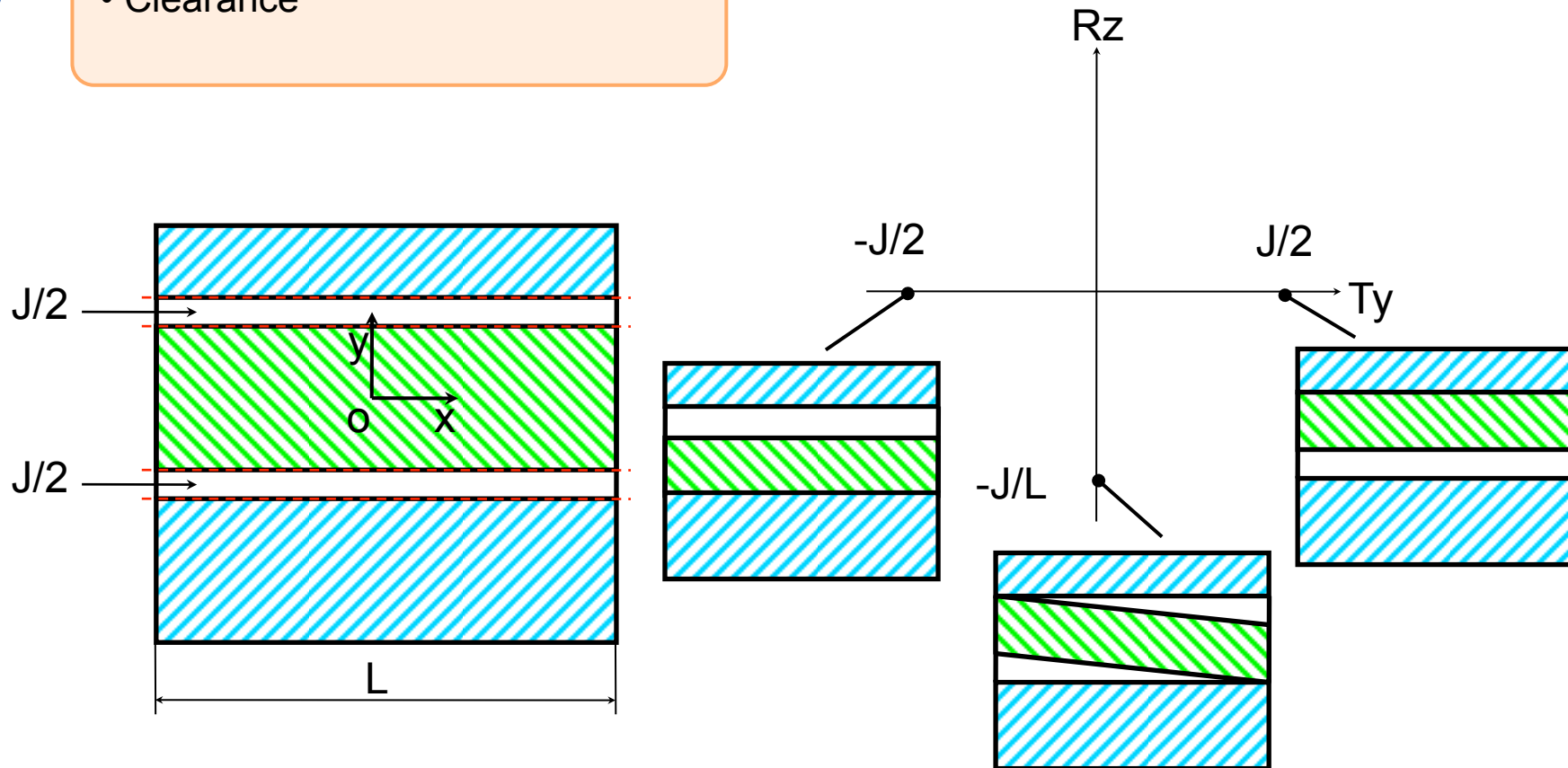

Theoretical assembly: clearance

Assumptions

- Rigid parts
- Clearance

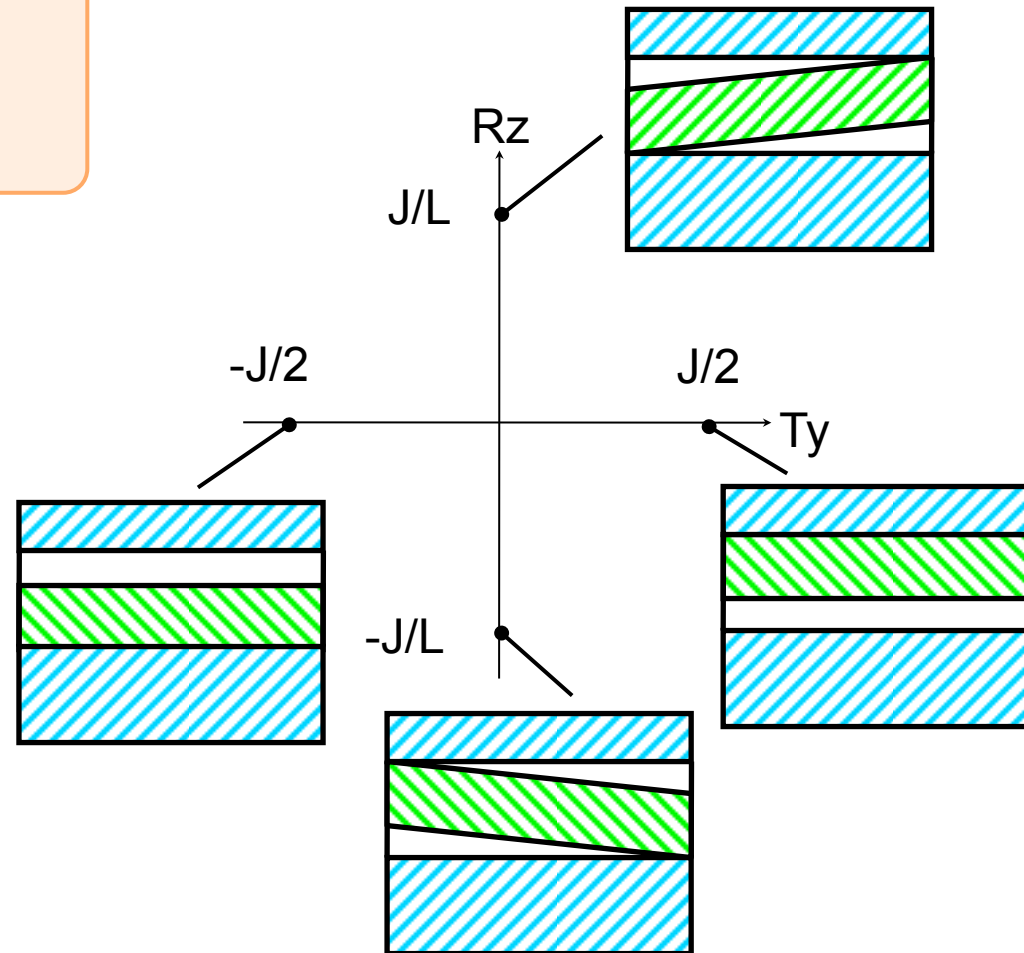
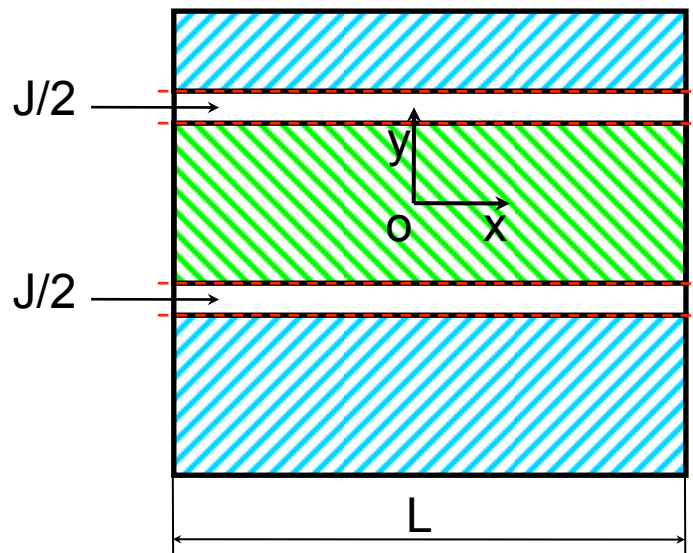

Theoretical assembly: clearance

Assumptions

- Rigid parts
- Clearance

→ No form deviations

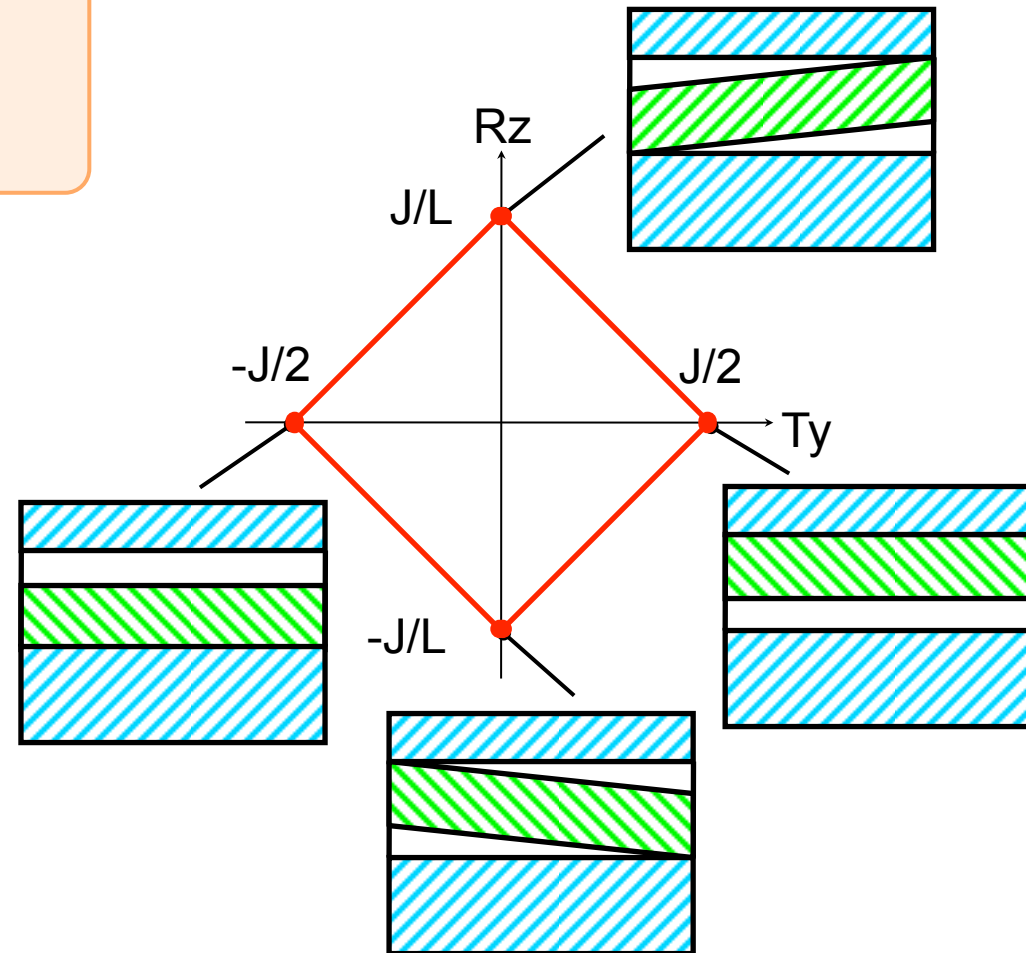
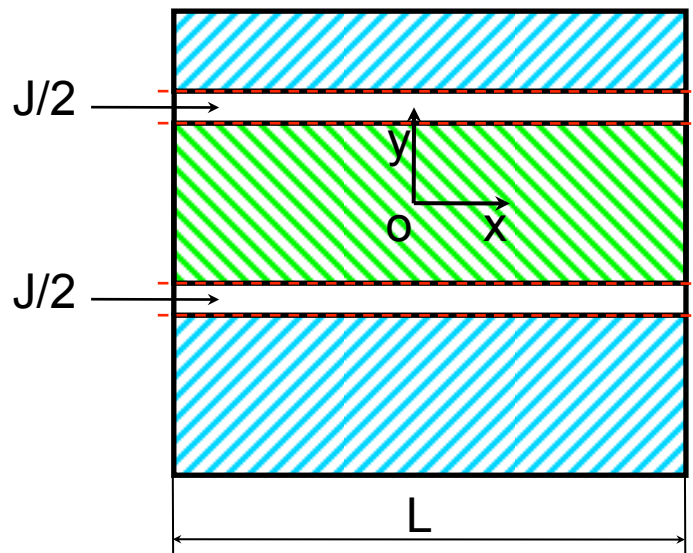



The modal parameterization of form deviations

Modal parameterization

- **Creation of a basis of elementary shape deviation:**
 - Based on the nominal geometry (CAD model),
 - Created by the modal vibration behaviour of the model,

Rigid modes

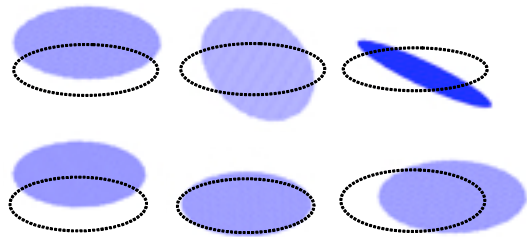

Vibration modes

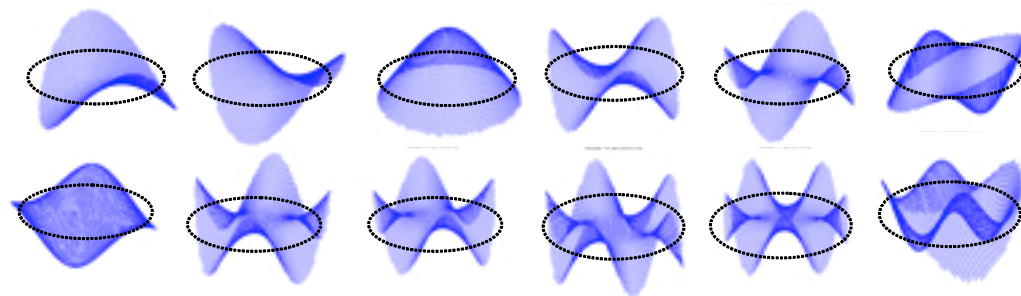

- **Properties of this approach:**
 - Applicable on all kind of geometry (profile, surface, ...),
 - Provides elementary form deviations with growing complexity,

Modal parameterization

- **Creation of a basis of elementary shape deviation:**
 - Based on the nominal geometry (CAD model),
 - Created by the modal vibration behaviour of the model,

Rigid modes

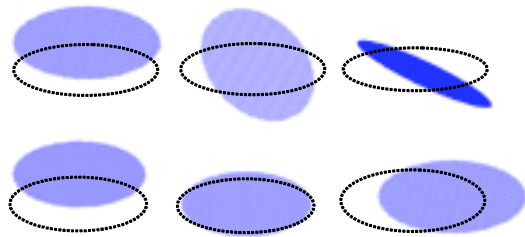

Vibration modes

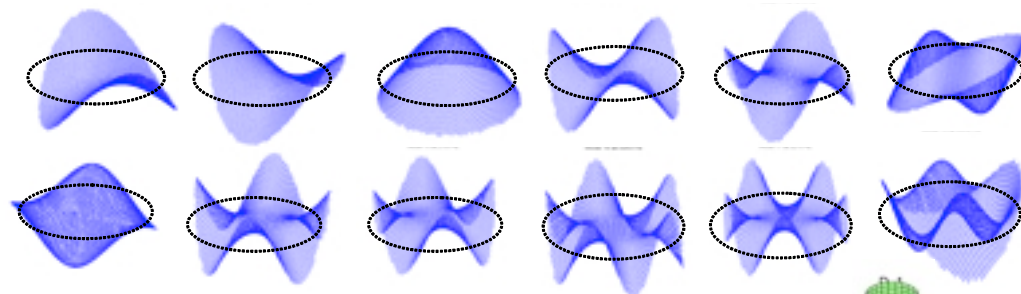

- **Properties of this approach:**
 - Applicable on all kind of geometry (profile, surface, ...),
 - Provides elementary form deviations with growing complexity,

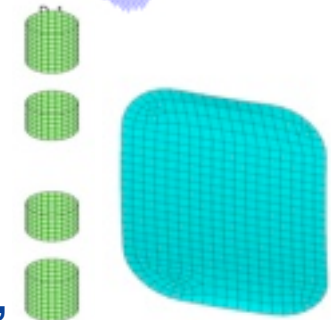
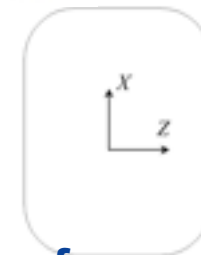

Modal parameterization

- An exhaustive basis of elementary form deviation

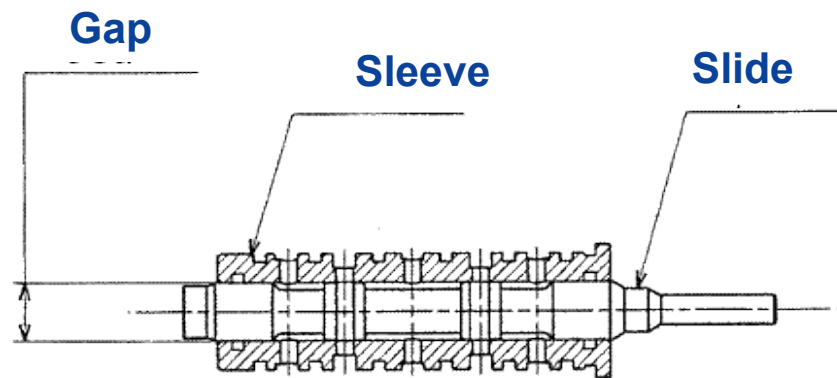

Modal parameterization

- An exhaustive basis of elementary form deviation

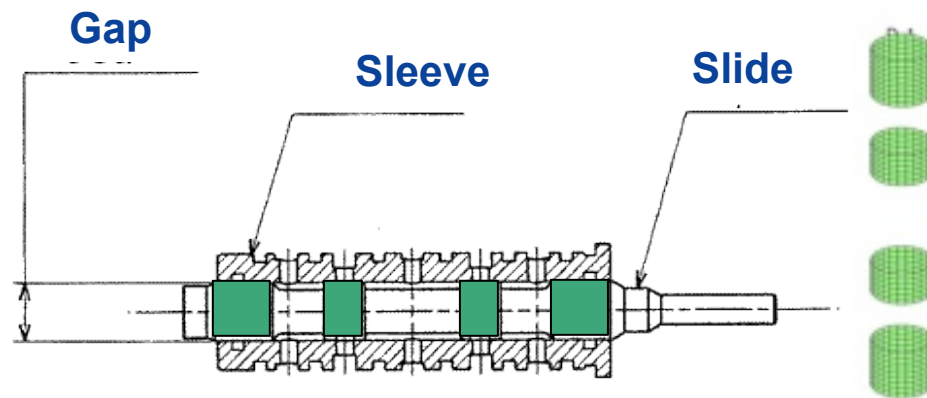

Modal parameterization

- An exhaustive basis of elementary form deviation

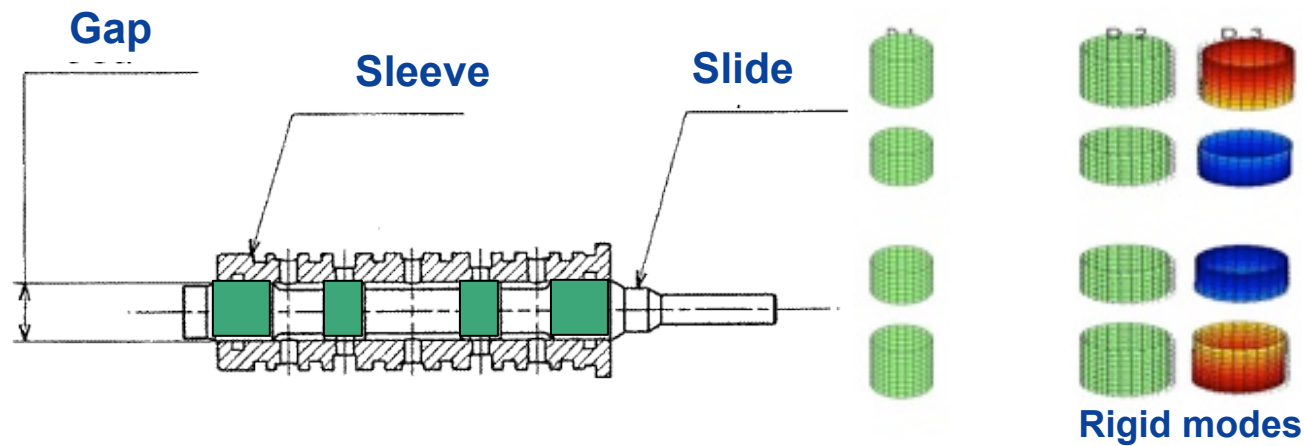

Modal parameterization

- An exhaustive basis of elementary form deviation

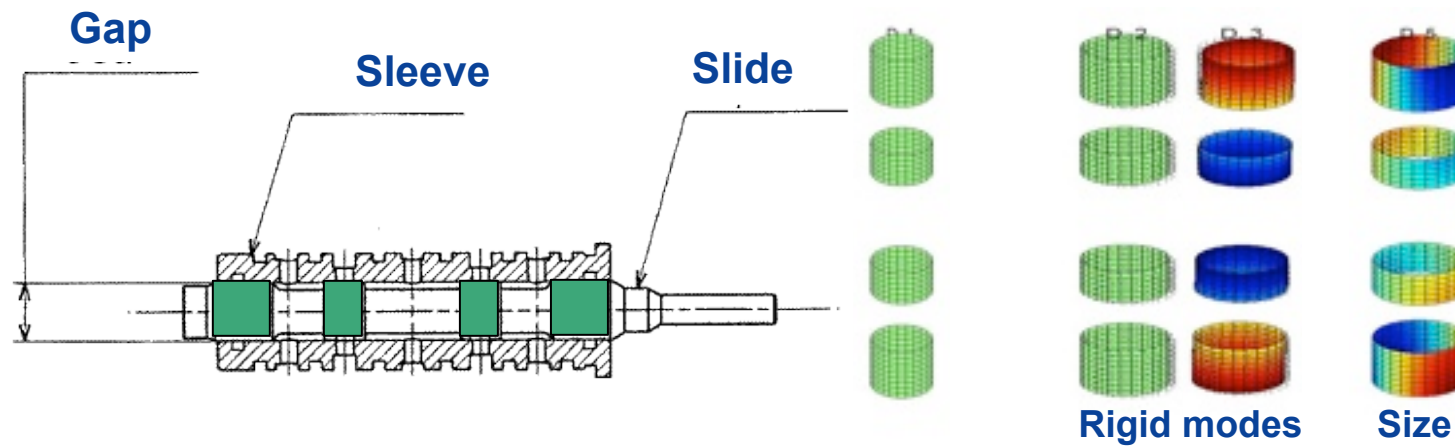

Modal parameterization

- An exhaustive basis of elementary form deviation

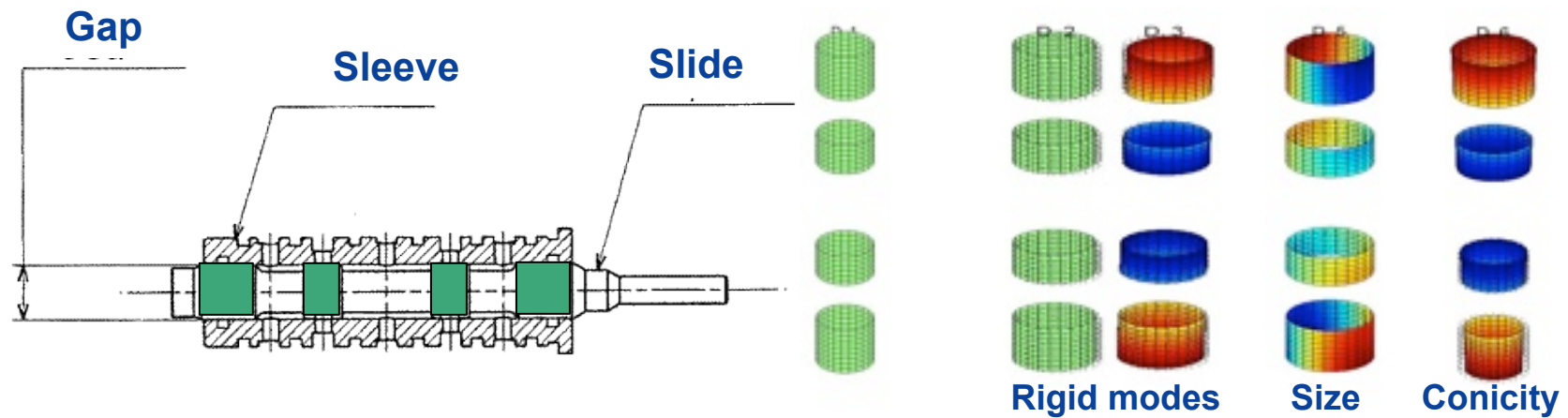

Modal parameterization

- An exhaustive basis of elementary form deviation

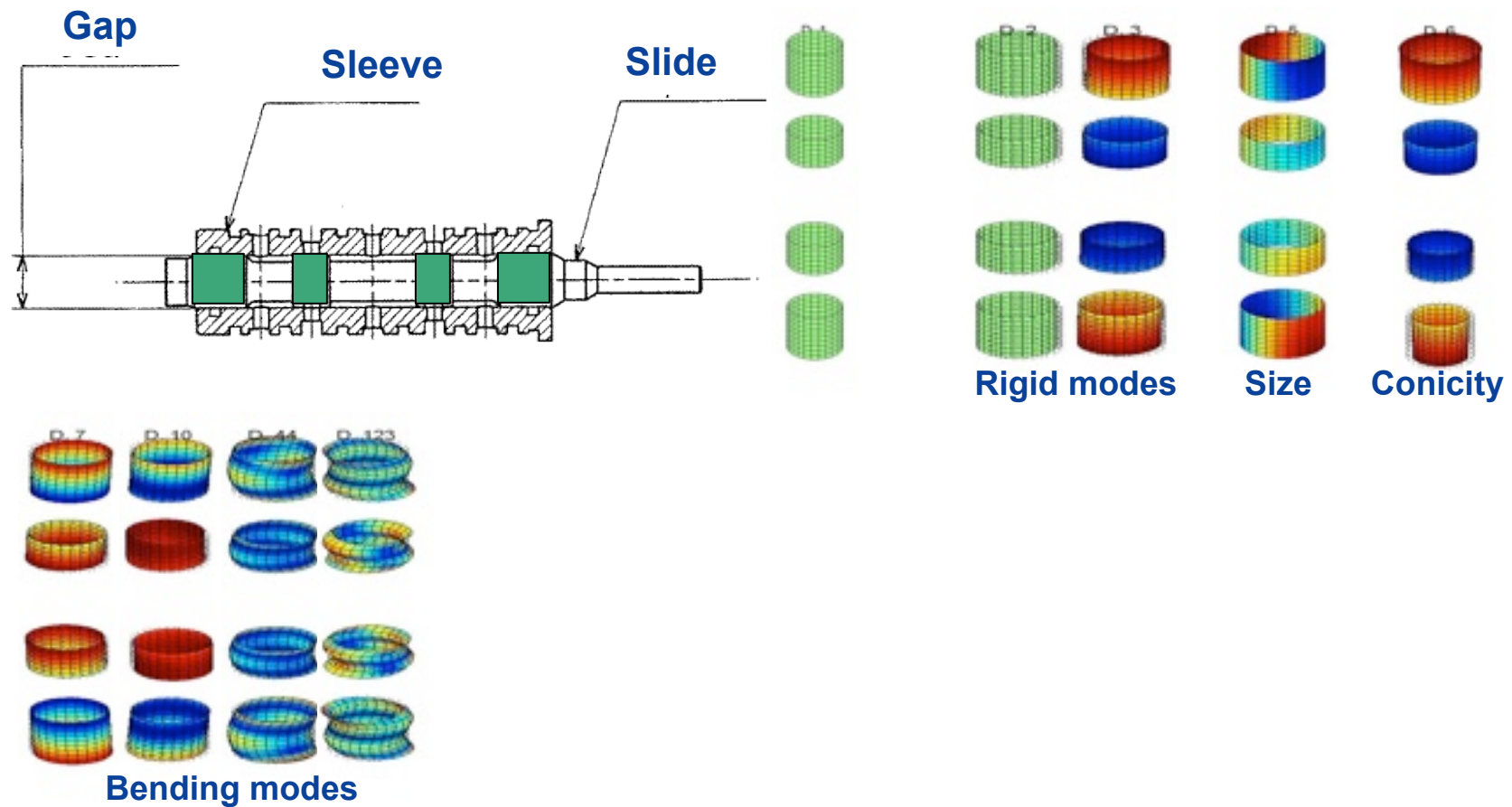

Modal parameterization

- An exhaustive basis of elementary form deviation

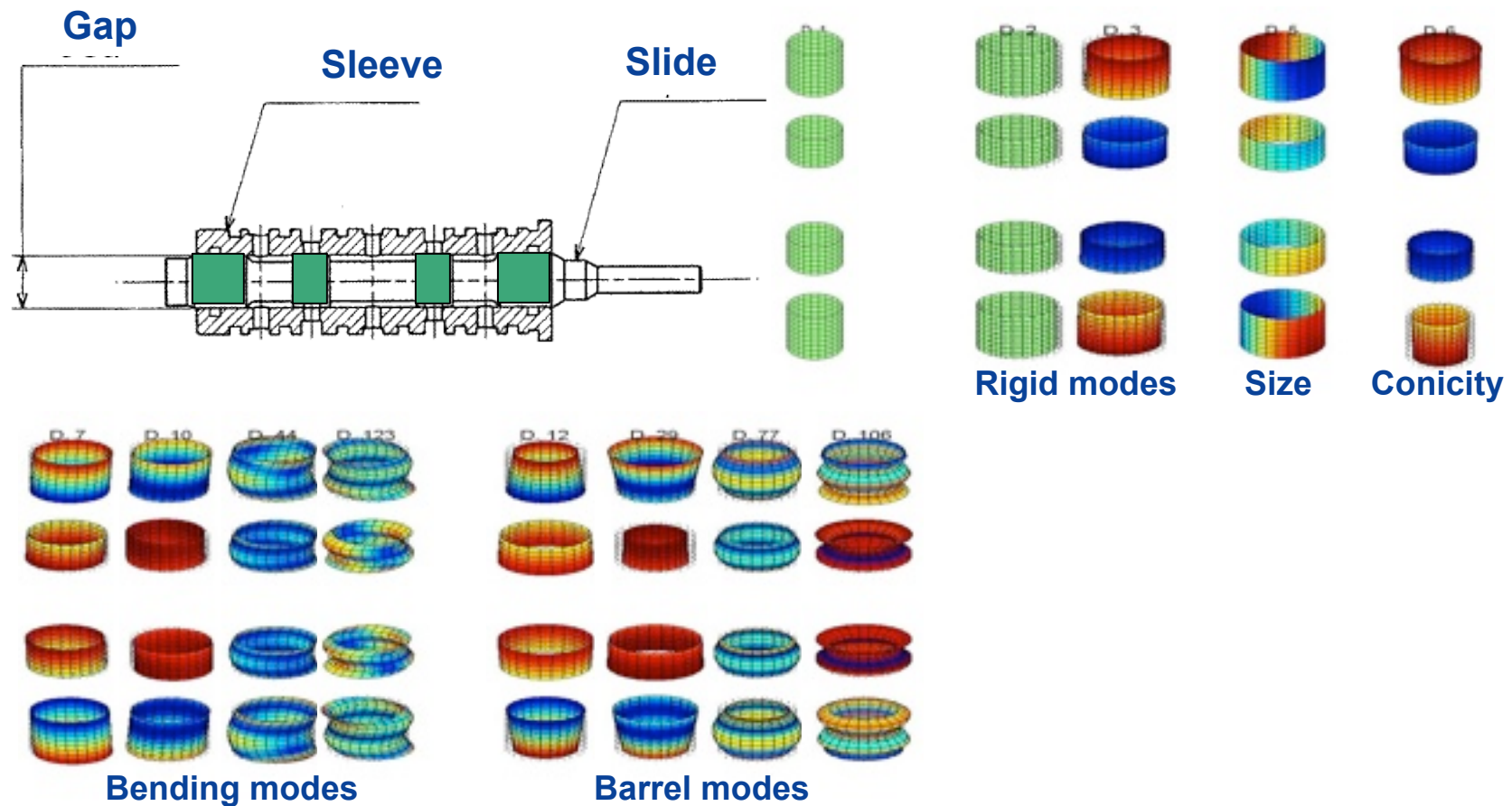

Modal parameterization

- An exhaustive basis of elementary form deviation

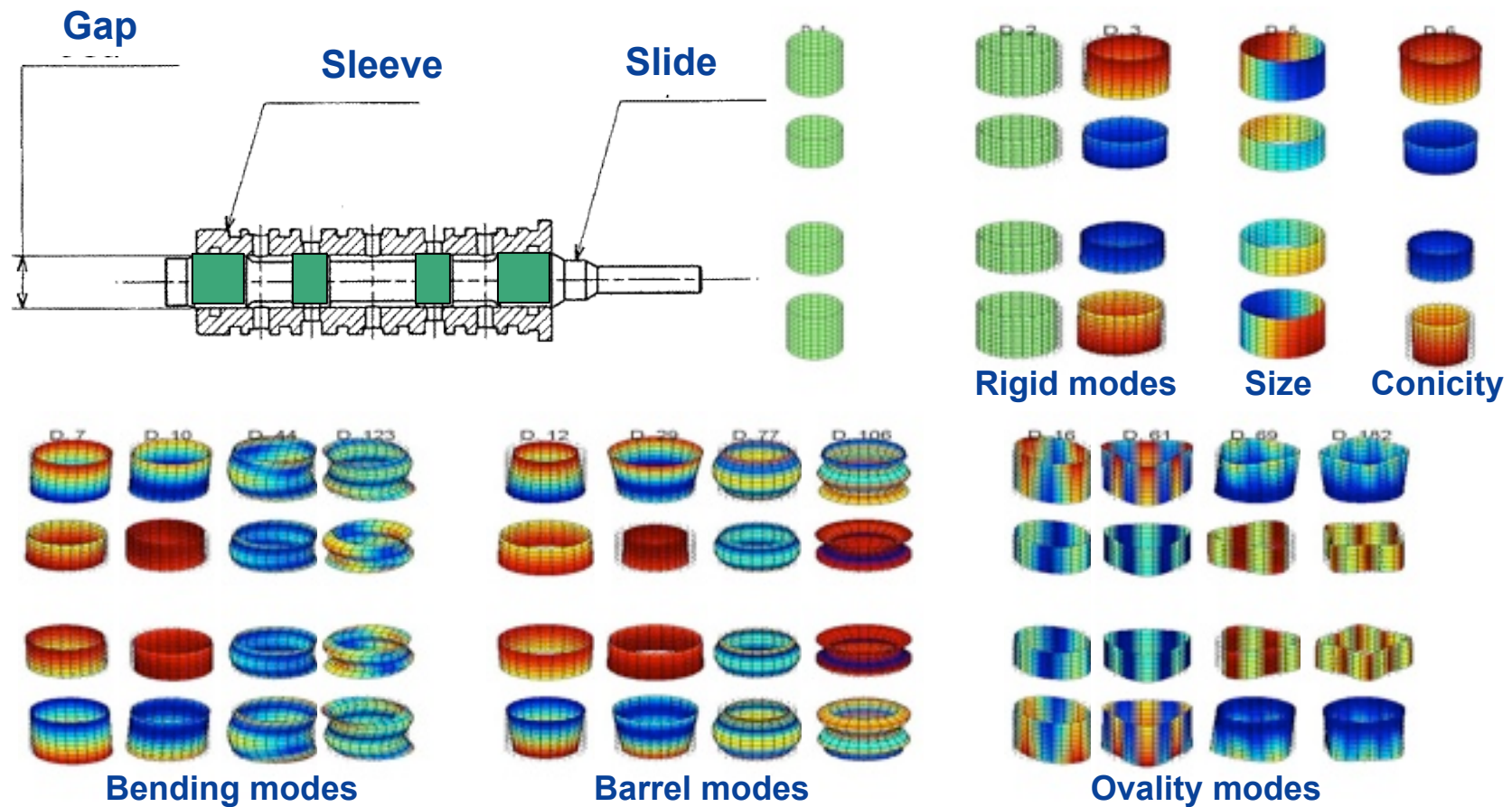

Modal parameterization

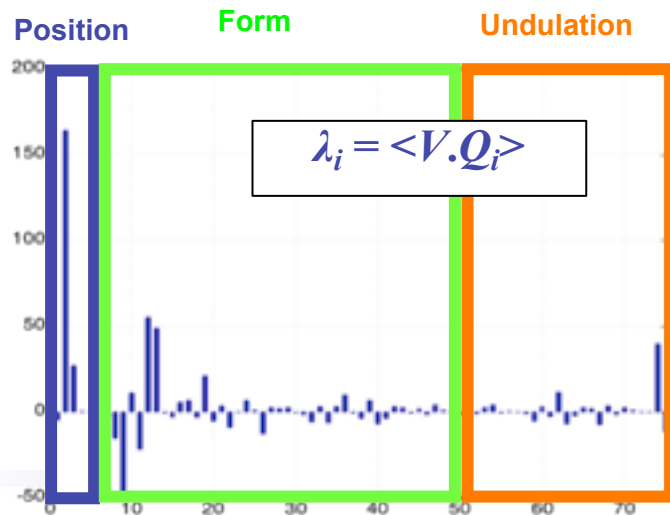

Decomposition

IPAS 2010 – February 2010 – ADRAGNA P.-A.

Reconstruction

Modal parameterization

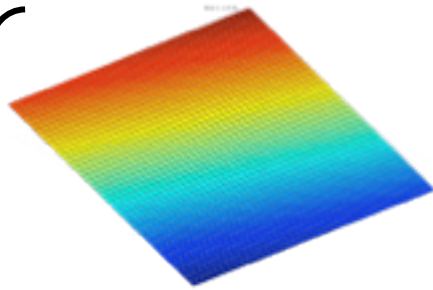

Mode 2

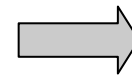
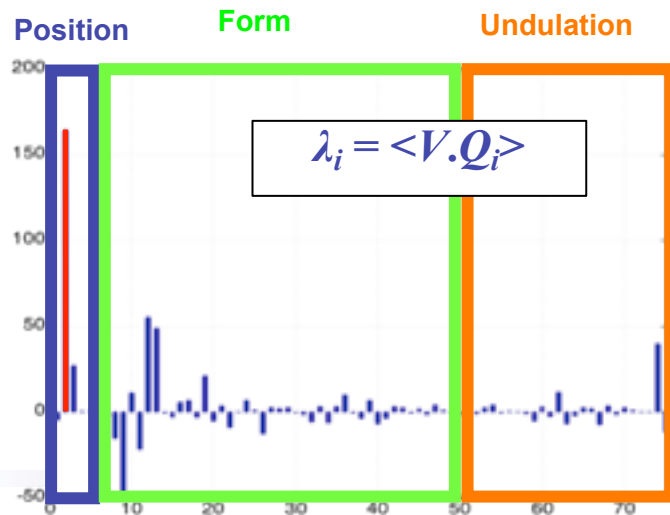

Reconstruction of the form = $\sum_{i=1}^{m=1} \lambda_i \cdot Q_i$

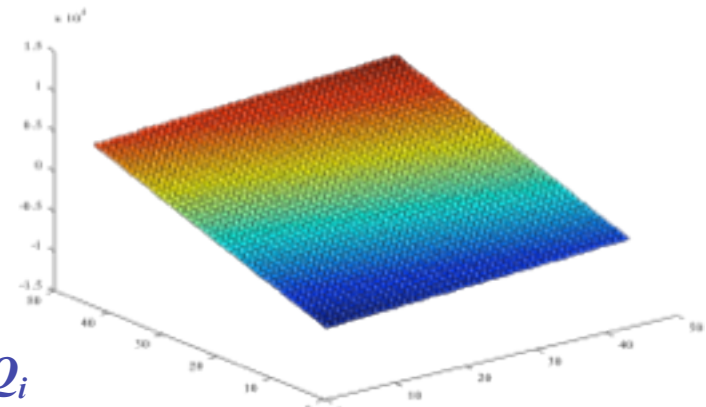

Reconstruction

Modal parameterization

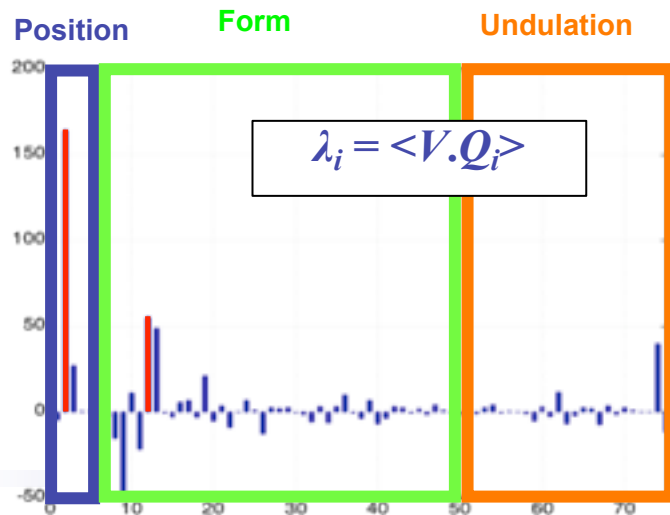
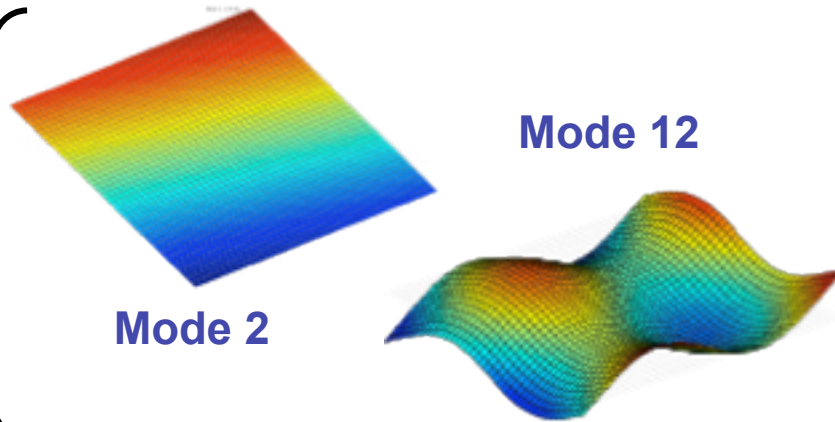

Reconstruction of the form = $\sum_{i=1}^{m=2} \lambda_i \cdot Q_i$

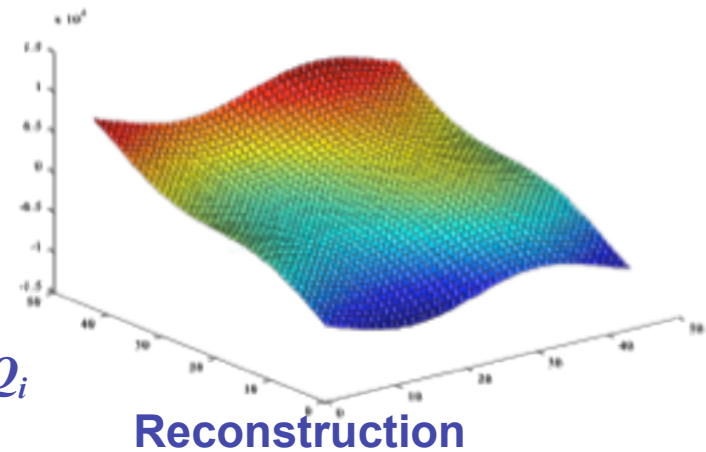

Modal parameterization

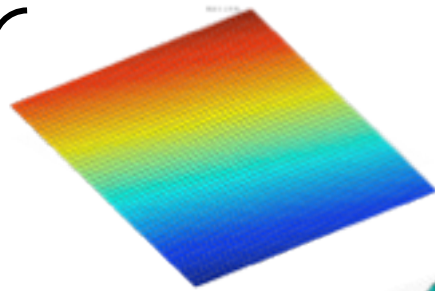

Mode 2

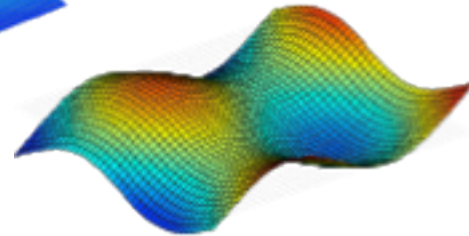

Mode 12

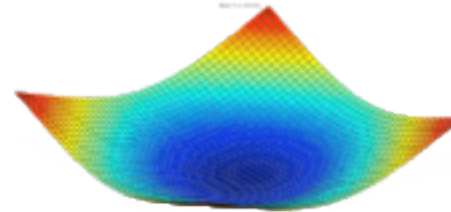

Mode 9

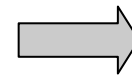
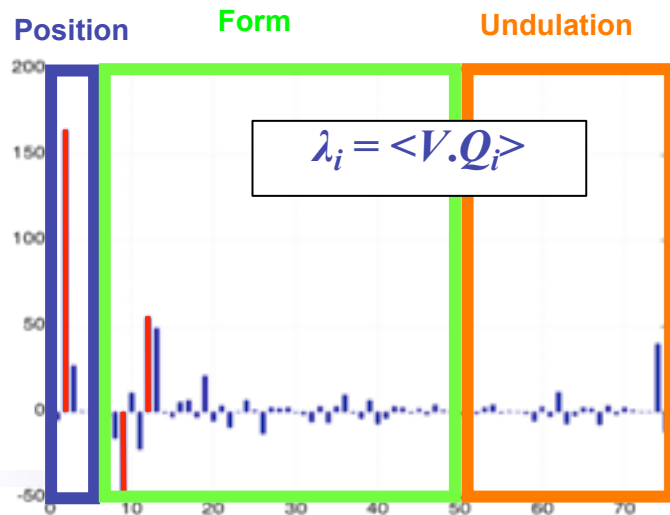

Reconstruction of the form = $\sum_{i=1}^{m=3} \lambda_i \cdot Q_i$

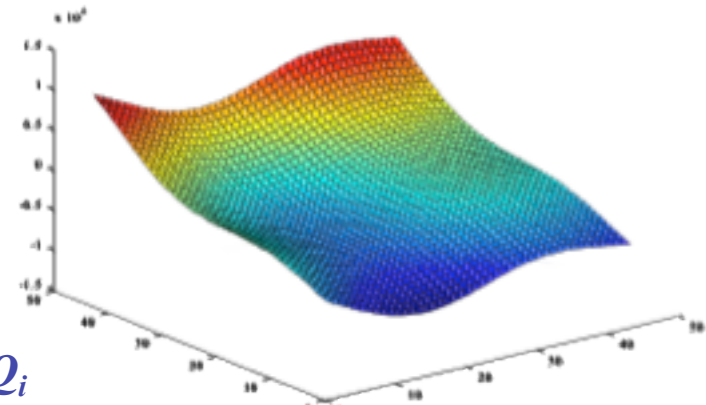

Reconstruction

Modal parameterization

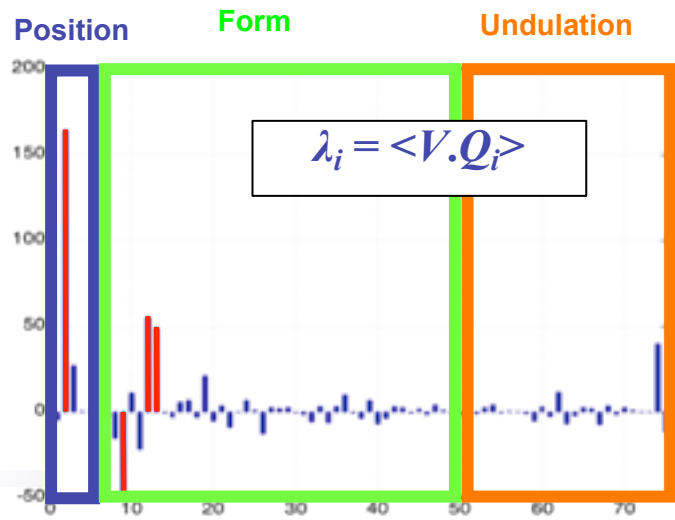
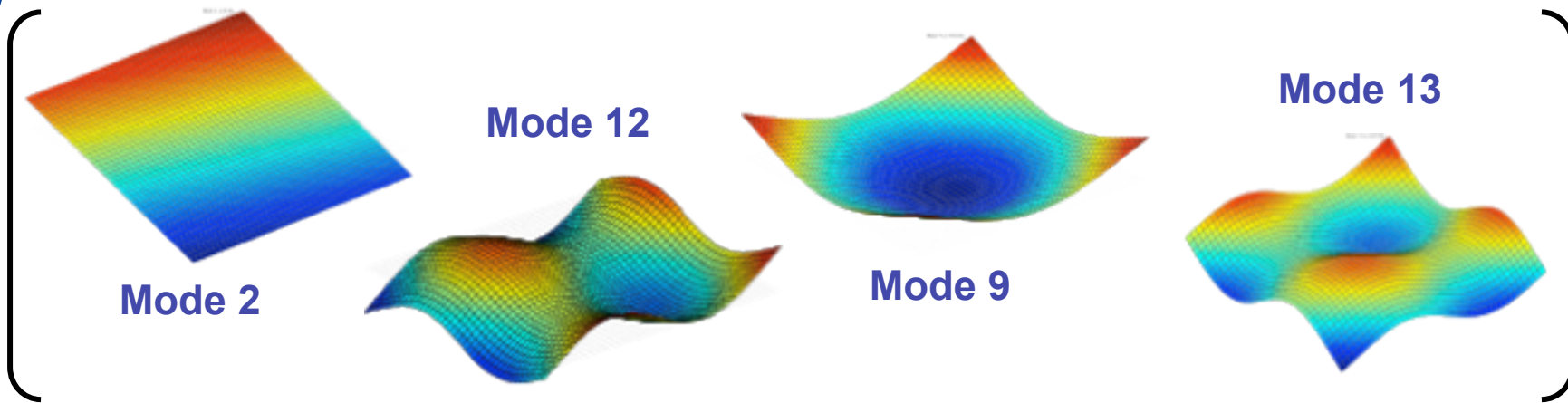

Reconstruction of the form = $\sum_{i=1}^{m=4} \lambda_i \cdot Q_i$

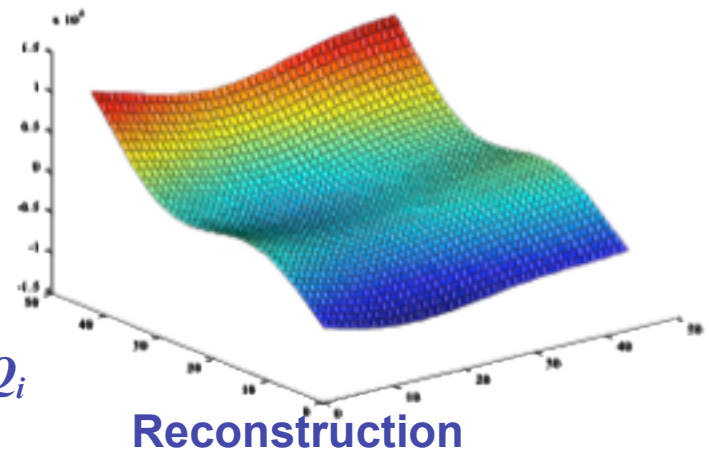

Modal parameterization

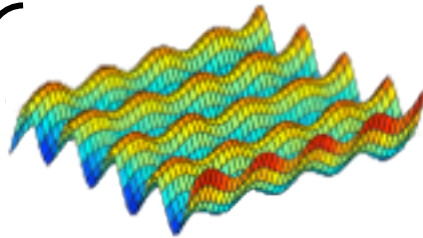

Mode 74

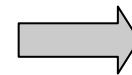
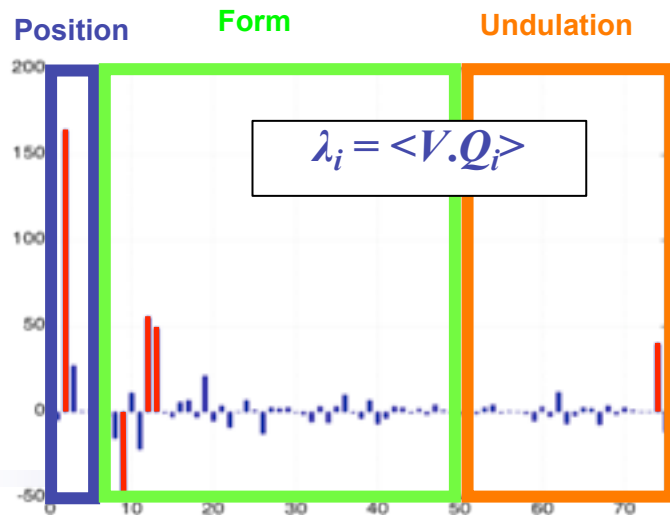

Reconstruction of the form = $\sum_{i=1}^{m=5} \lambda_i \cdot Q_i$

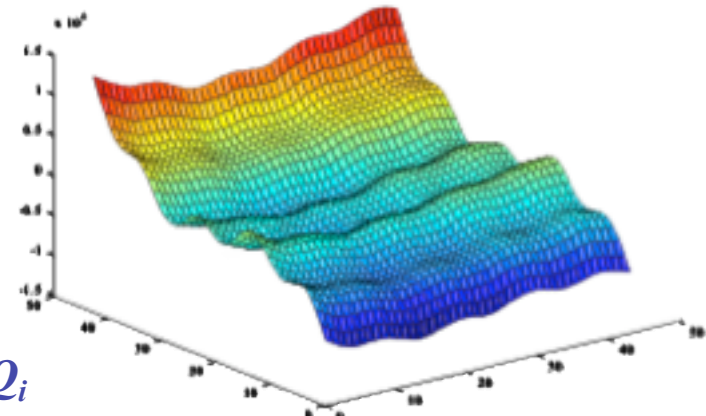

Reconstruction

Modal parameterization

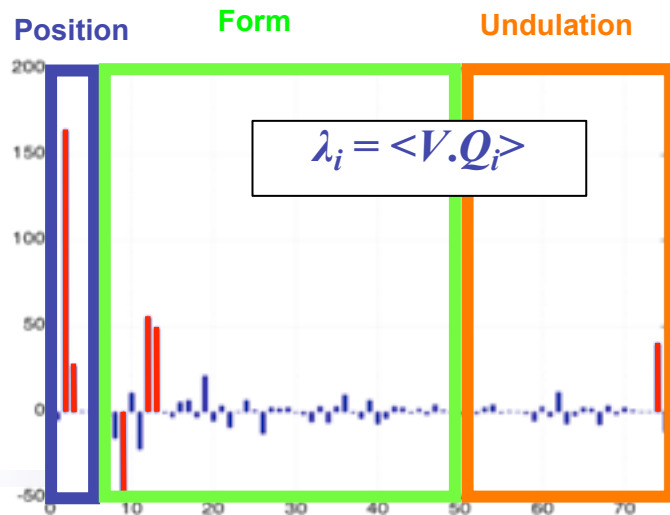
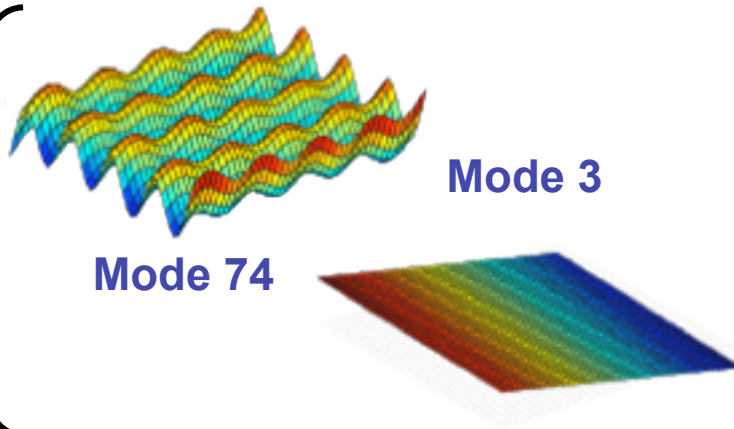

Reconstruction of the form = $\sum_{i=1}^{m=6} \lambda_i \cdot Q_i$

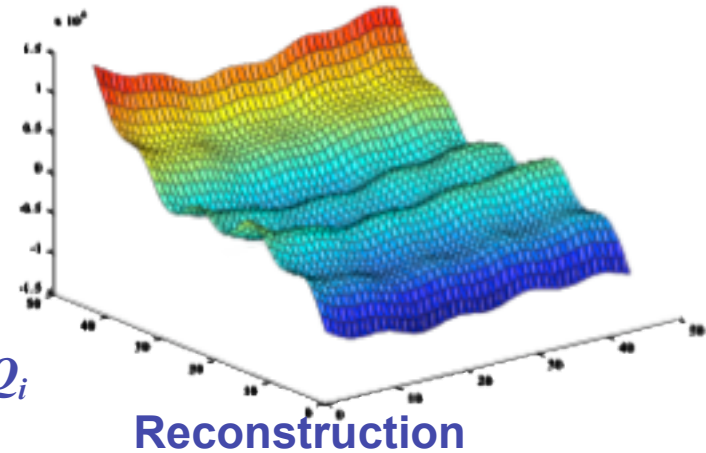

Modal parameterization

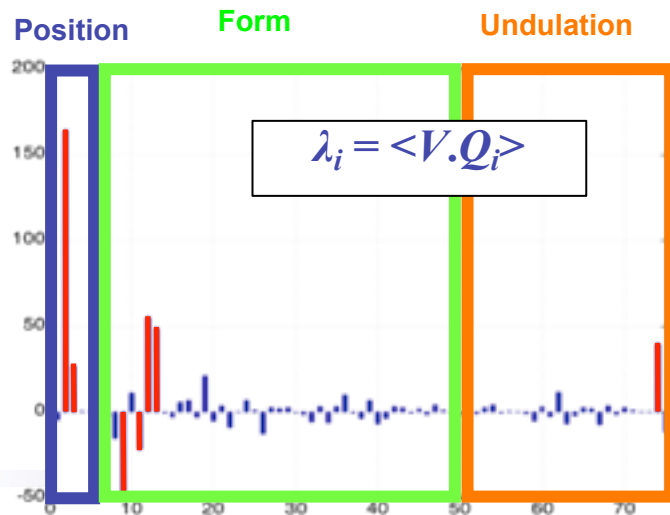
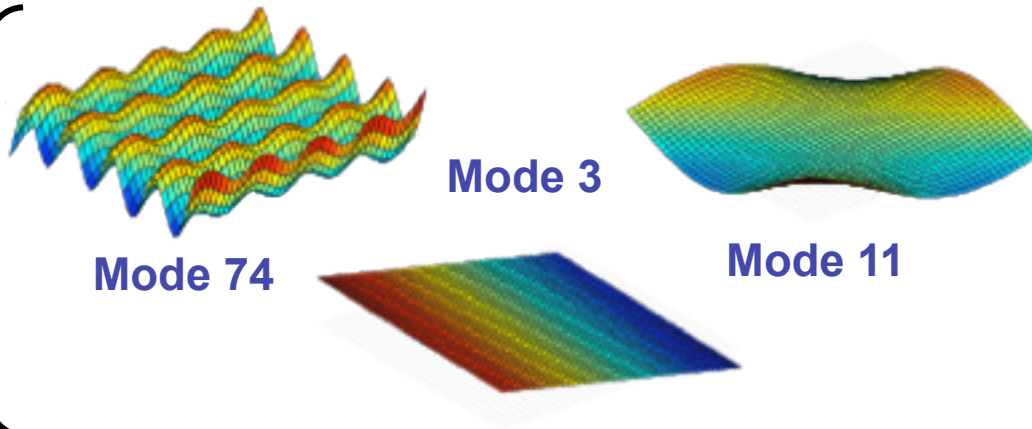

Reconstruction of the form = $\sum_{i=1}^{m=7} \lambda_i \cdot Q_i$

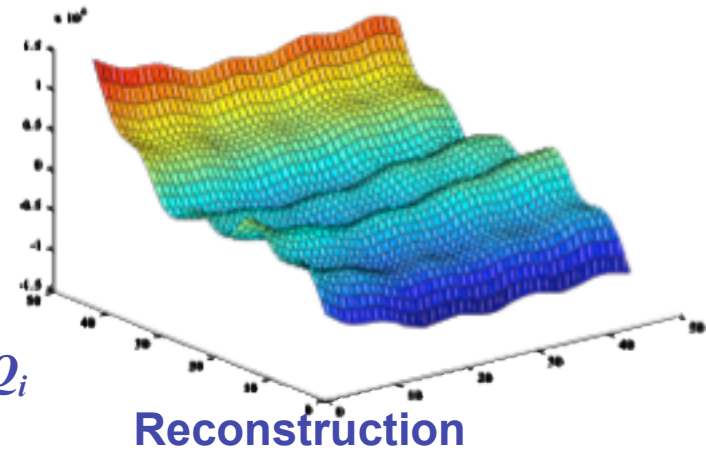

Modal parameterization

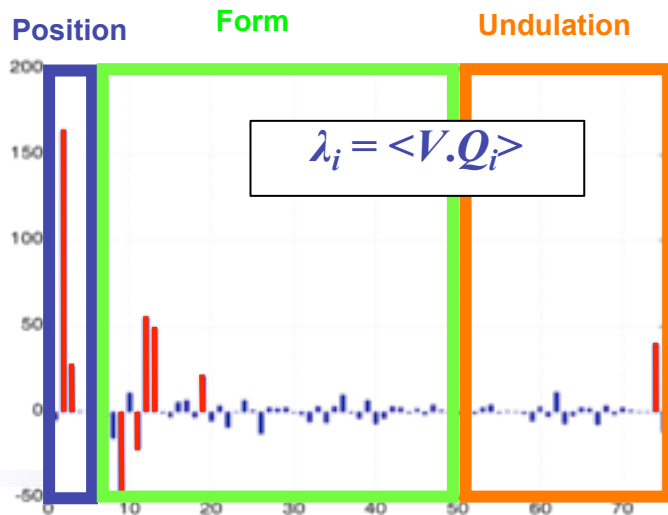
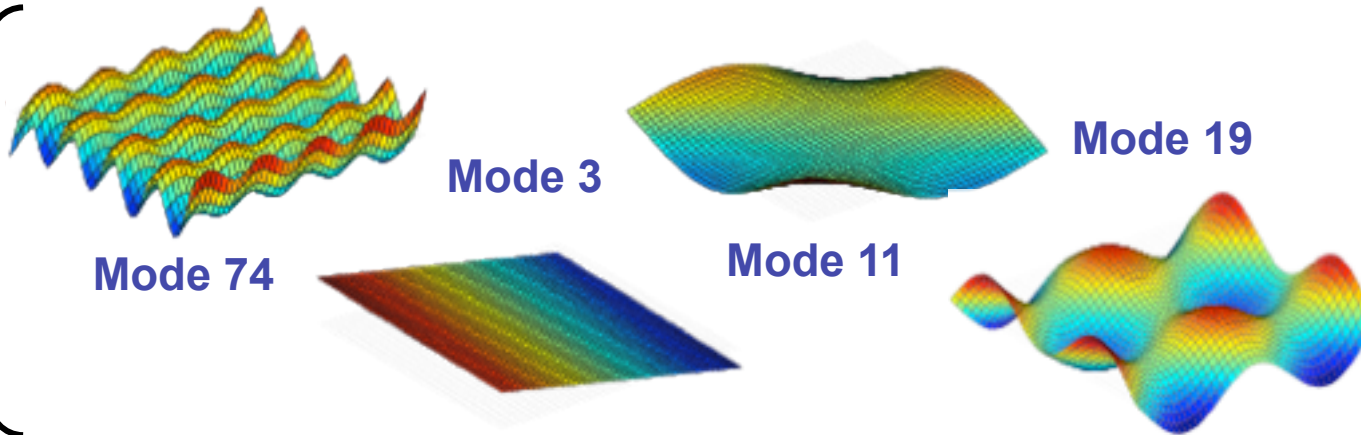

Reconstruction of the form = $\sum_{i=1}^{m=8} \lambda_i \cdot Q_i$

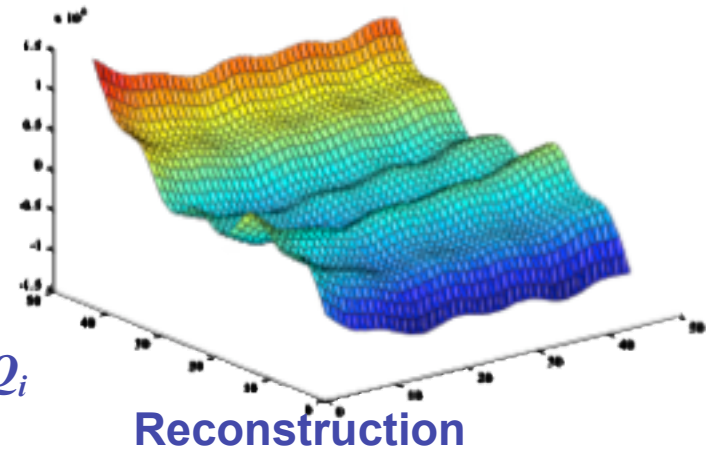

Modal parameterization

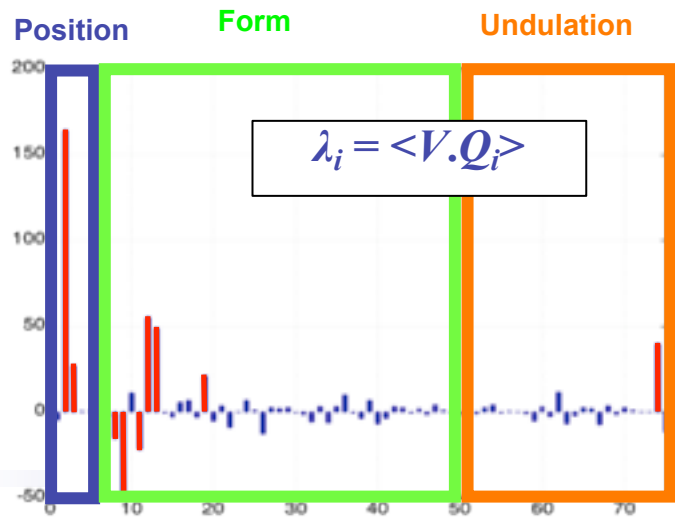
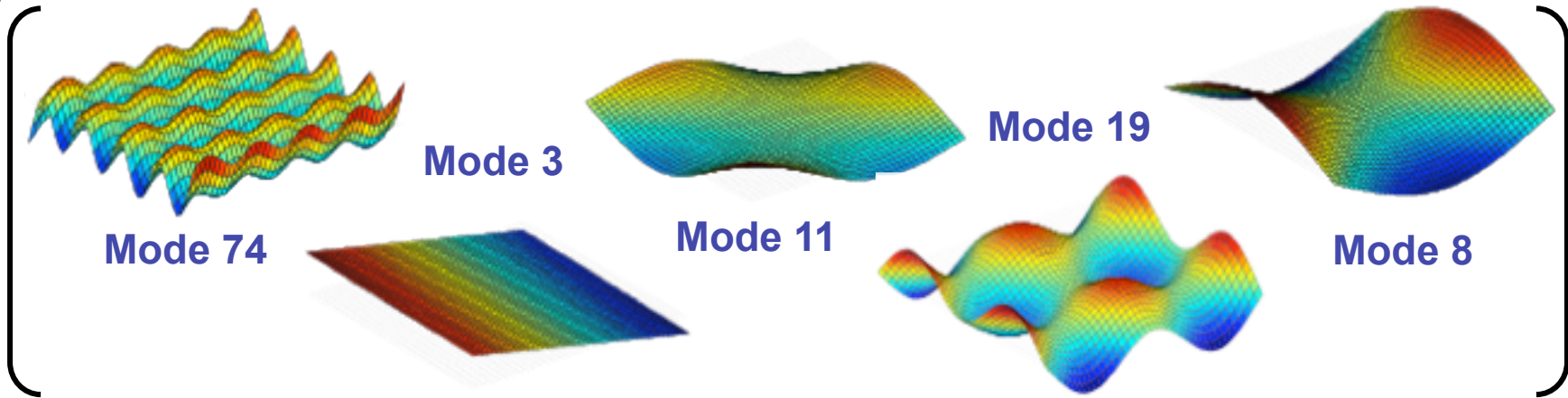

Reconstruction of the form = $\sum_{i=1}^{m=9} \lambda_i \cdot Q_i$

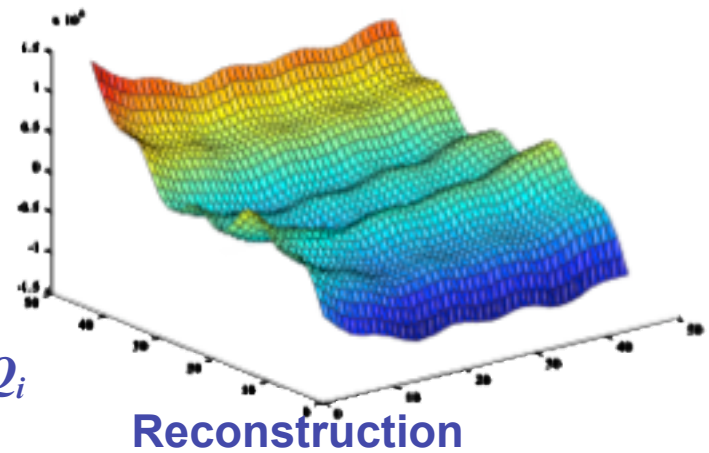

Decomposition

IPAS 2010 – February 2010 – ADRAGNA P.-A.

Modal parameterization and GPS criterion

Modal parameterization and GPS criterion

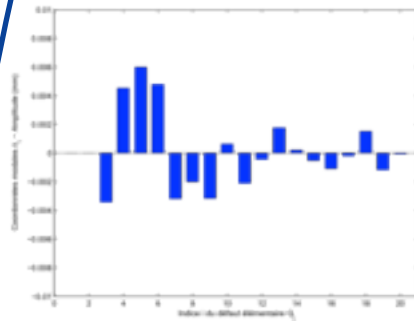

Modal parameterization and GPS criterion

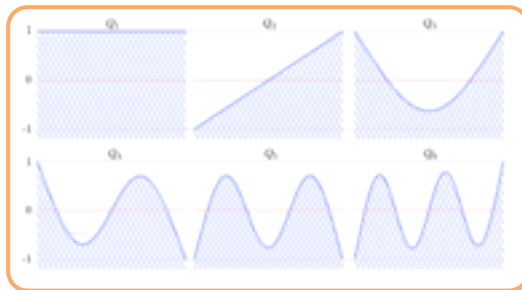
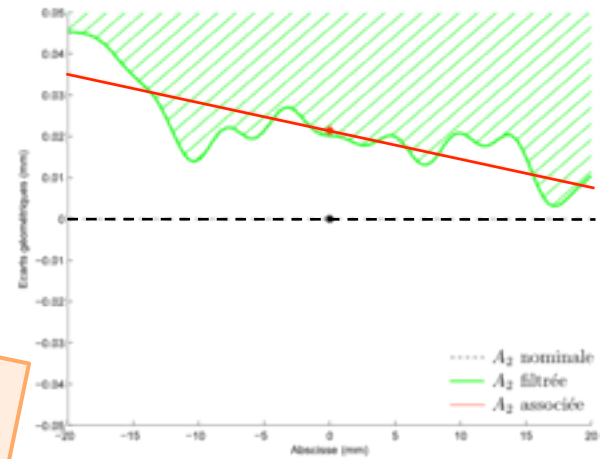
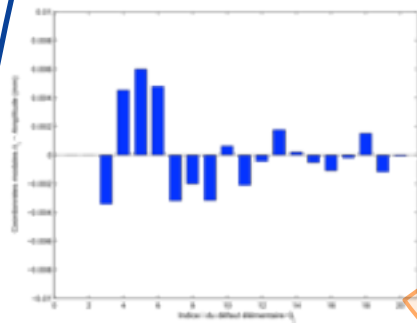

Modal parameterization and GPS criterion

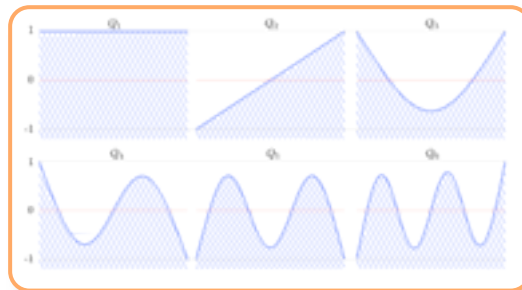
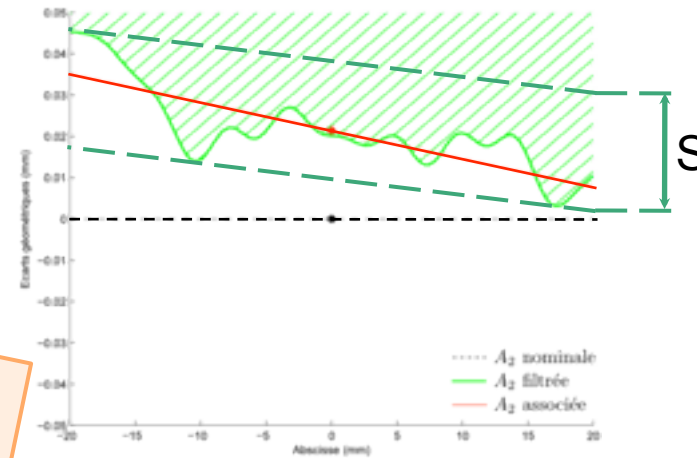
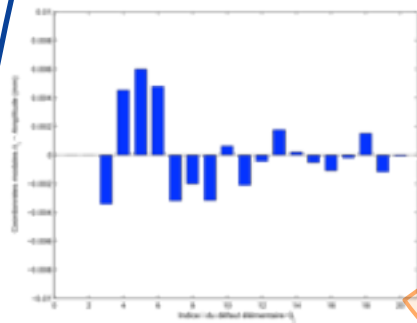

S = Strength : *GPS définition*

Modal parameterization and GPS criterion

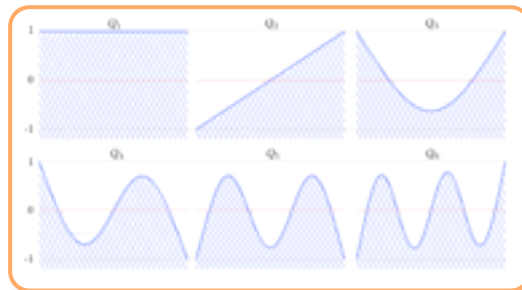
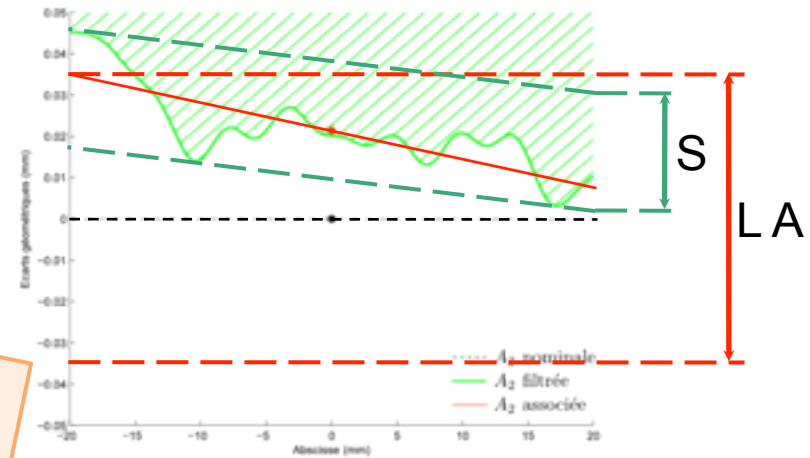
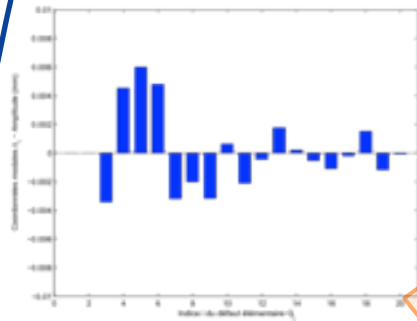

S = Strength : *GPS définition*

LA = Localisation of the Associated geometry : *GPS définition applied to the associated geometry*



Influence of form deviations in parts stack up

Assembly and form deviations

Assumptions

- Rigid parts
- No clearance
- Positioning force

→ Considering the form deviations

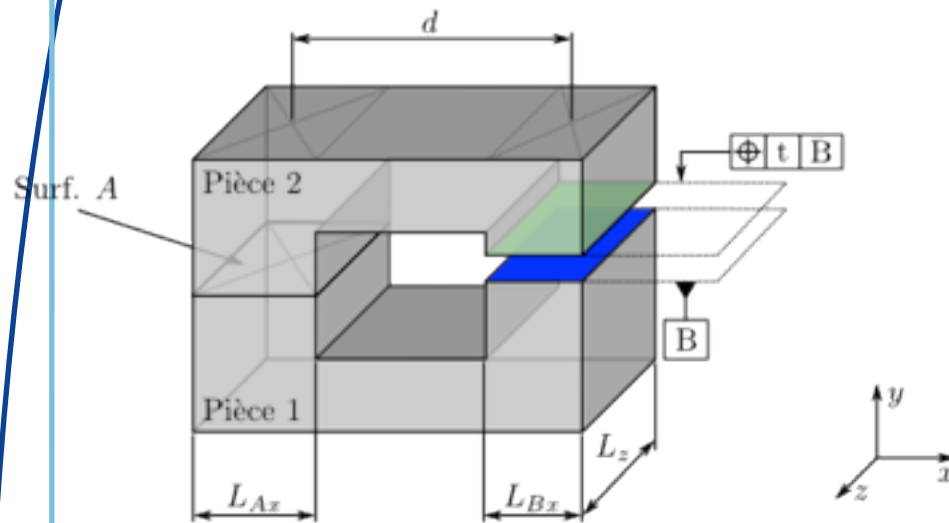

$$L_{Ax} = 40 \text{ mm}$$

$$L_{Bx} = 20 \text{ mm}$$

$$L_z = 40 \text{ mm}$$

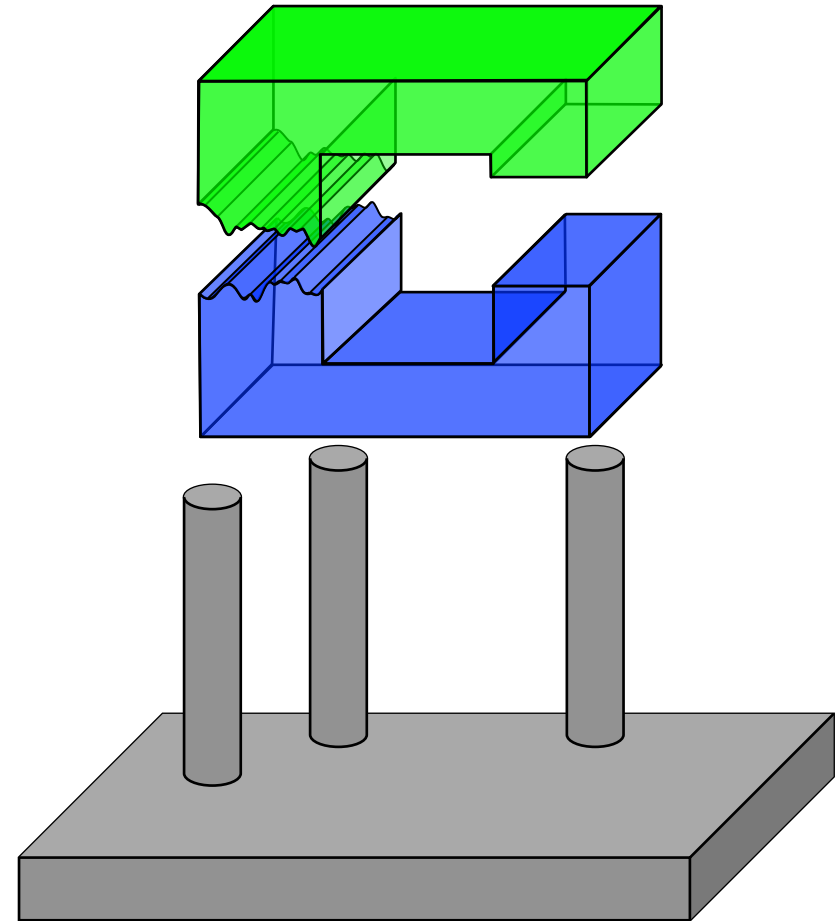

Assembly and form deviations

Assumptions

- Rigid parts
- No clearance
- Positioning force

→ Considering the form deviations

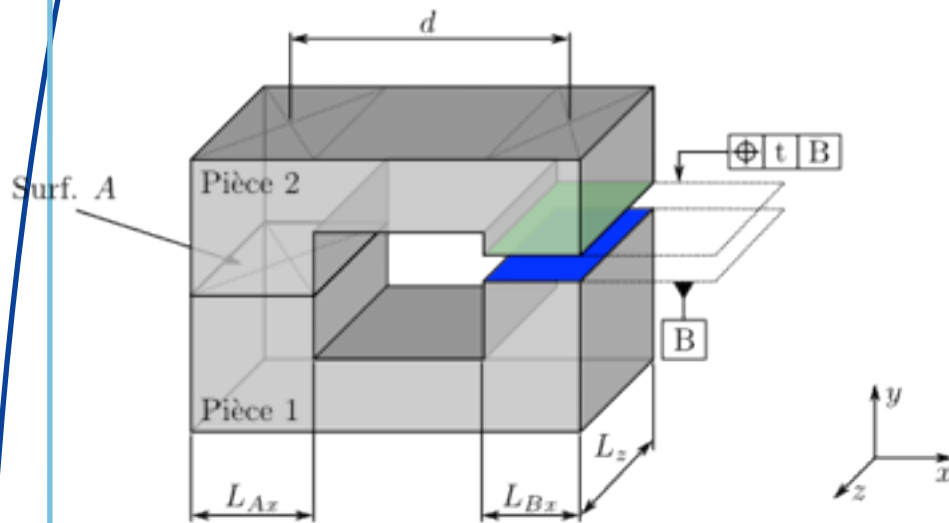

$L_{Ax} = 40 \text{ mm}$
 $L_{Bx} = 20 \text{ mm}$
 $L_z = 40 \text{ mm}$

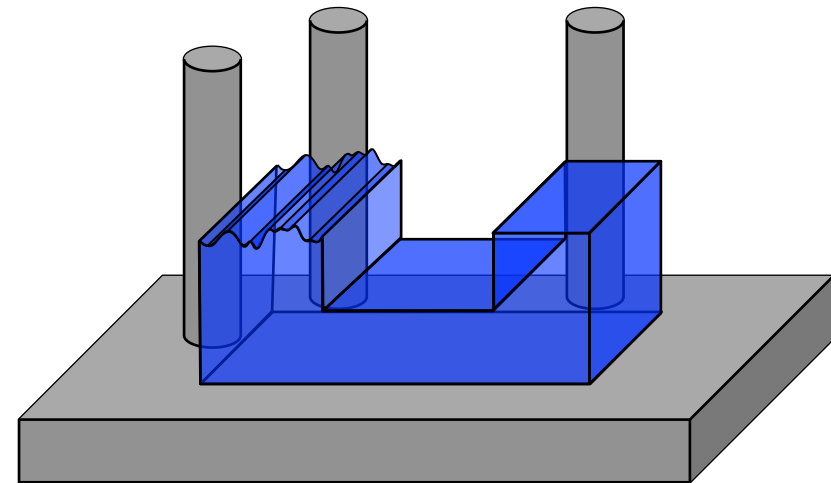
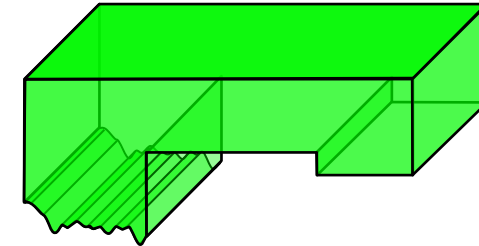

Assembly and form deviations

Assumptions

- Rigid parts
- No clearance
- Positioning force

→ Considering the form deviations

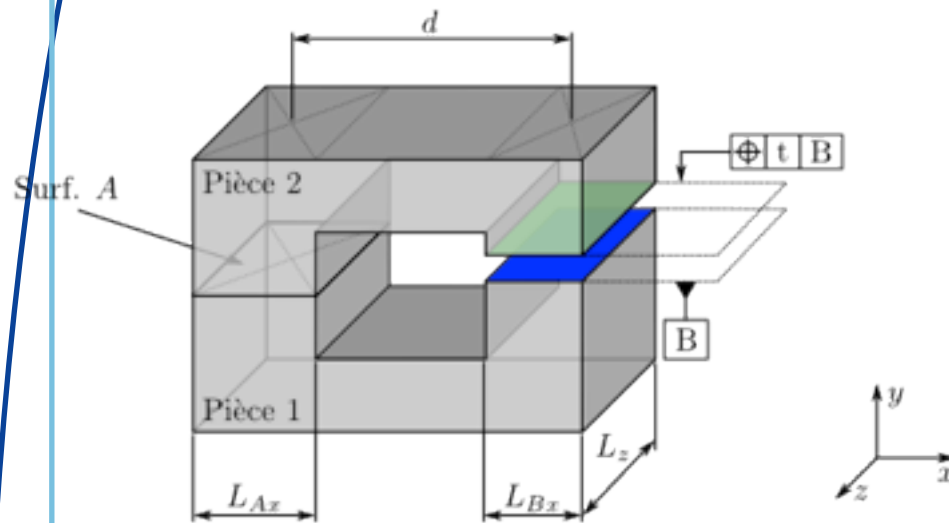

$$L_{Ax} = 40 \text{ mm}$$

$$L_{Bx} = 20 \text{ mm}$$

$$L_z = 40 \text{ mm}$$

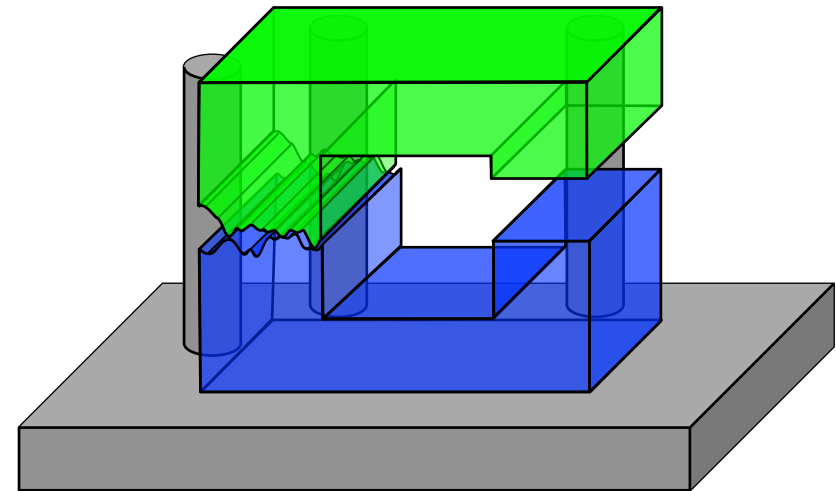

Assembly and form deviations

Assumptions

- Rigid parts
- No clearance
- Positioning force

→ Considering the form deviations

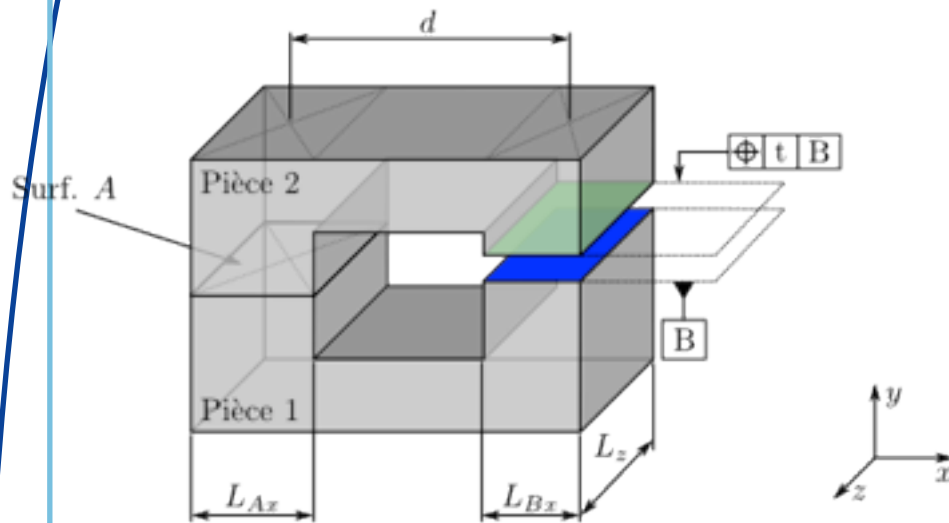

$$L_{Ax} = 40 \text{ mm}$$

$$L_{Bx} = 20 \text{ mm}$$

$$L_z = 40 \text{ mm}$$

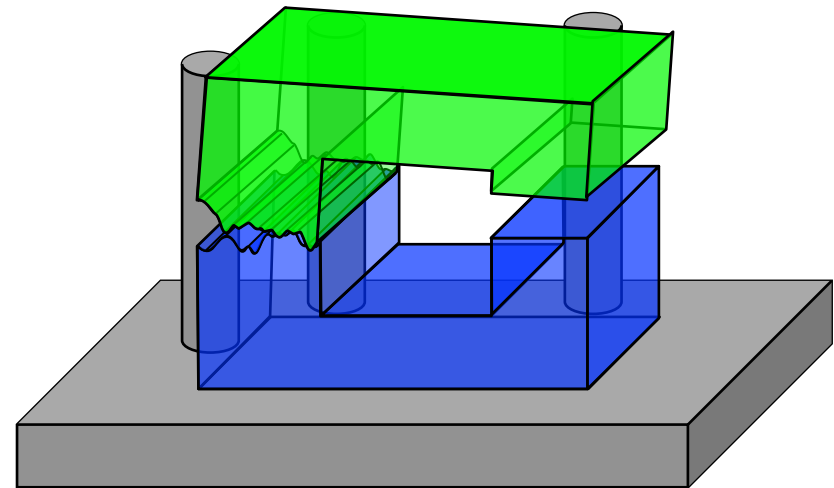

Assembly and form deviations

Assumptions

- Rigid parts
- No clearance
- Positioning force

→ Considering the form deviations

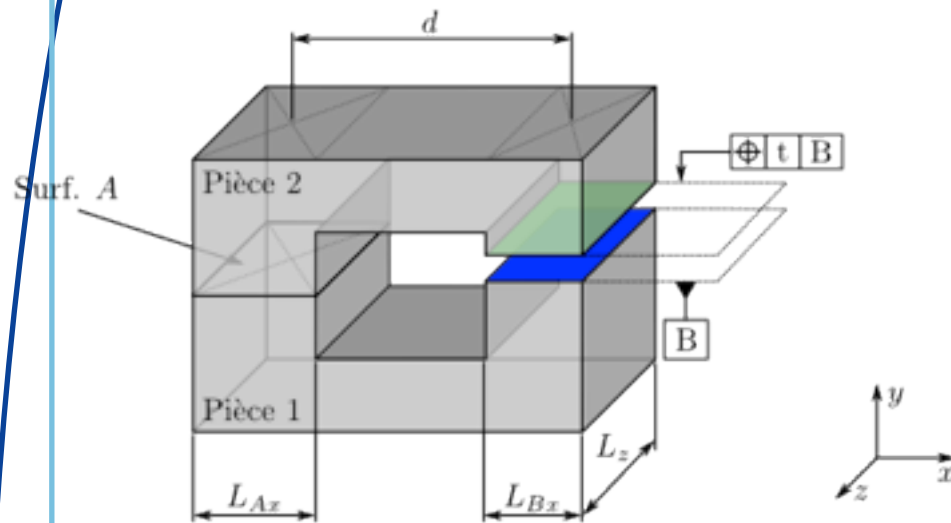

$$\begin{aligned} L_{Ax} &= 40 \text{ mm} \\ L_{Bx} &= 20 \text{ mm} \\ L_z &= 40 \text{ mm} \end{aligned}$$

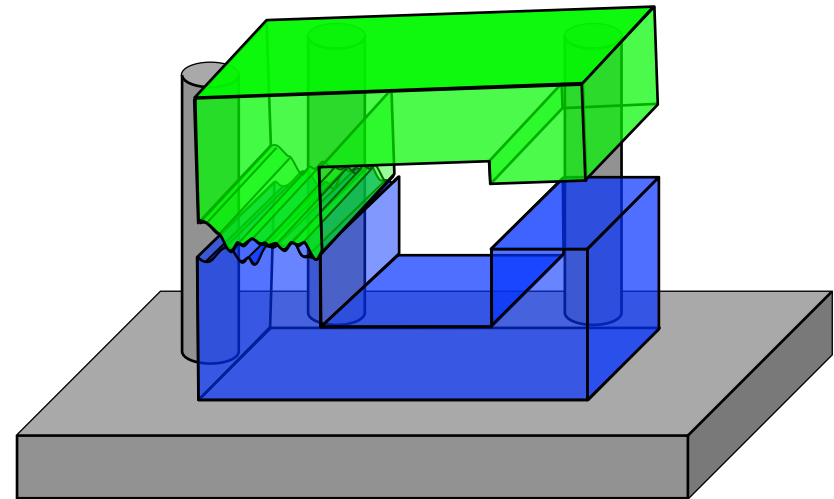

Assembly and form deviations

Assumptions

- Rigid parts
- No clearance
- Positioning force

→ Considering the form deviations

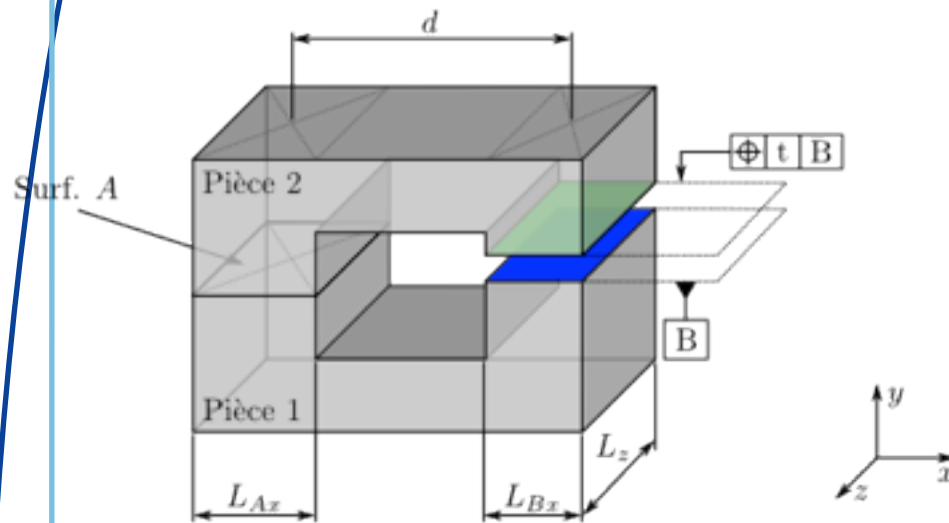

$$L_{Ax} = 40 \text{ mm}$$

$$L_{Bx} = 20 \text{ mm}$$

$$L_z = 40 \text{ mm}$$

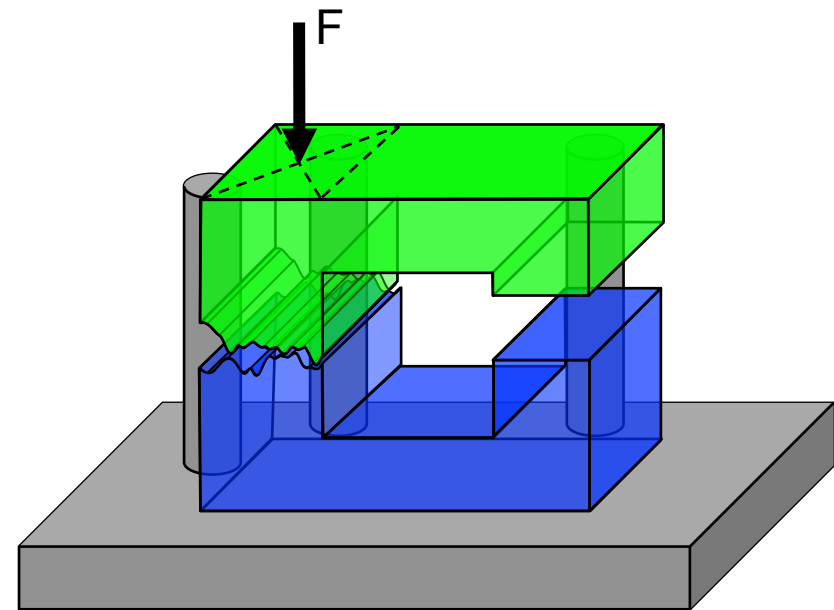

Assembly and form deviations

Assumptions

- Rigid parts
- No clearance
- Positioning force

→ Considering the form deviations

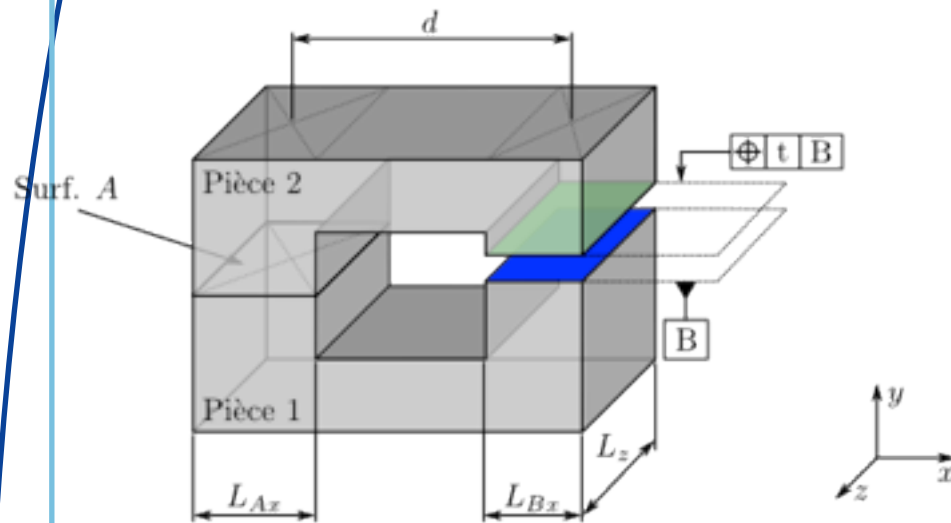

$$\begin{aligned} L_{Ax} &= 40 \text{ mm} \\ L_{Bx} &= 20 \text{ mm} \\ L_z &= 40 \text{ mm} \end{aligned}$$

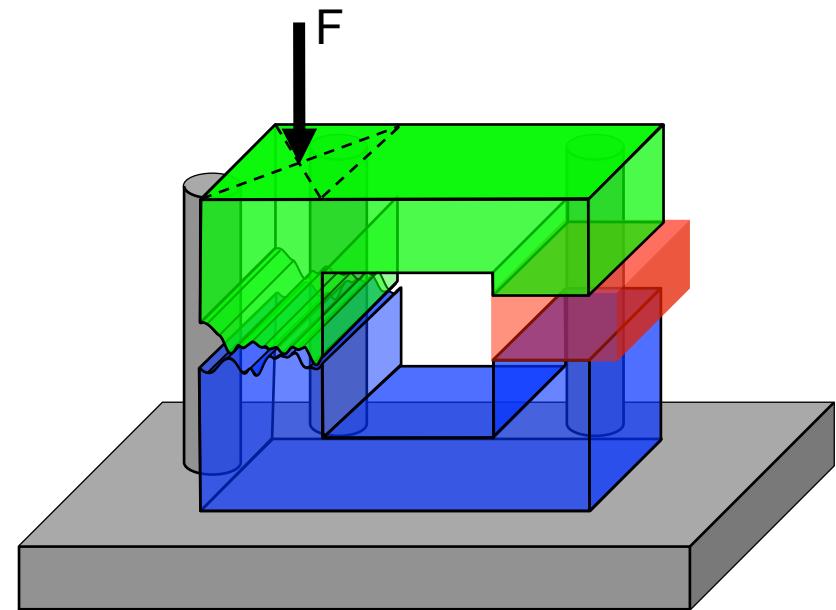

Assembly and form deviations

Assembly and form deviations

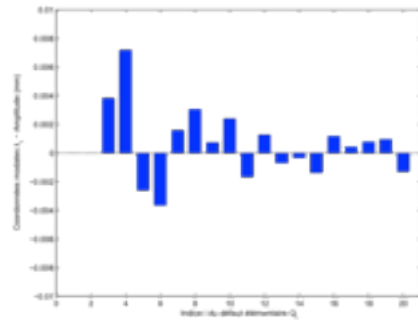
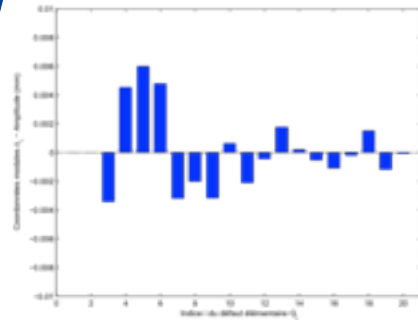

Assembly and form deviations

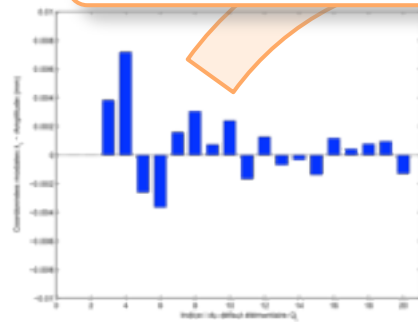
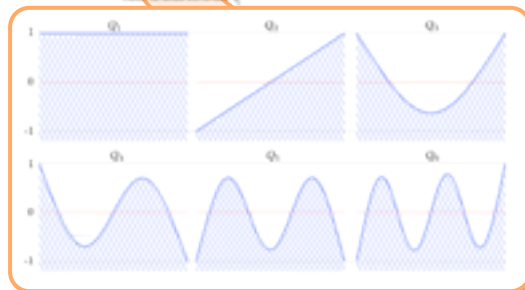
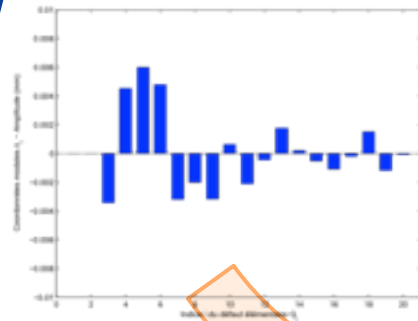

Assembly and form deviations

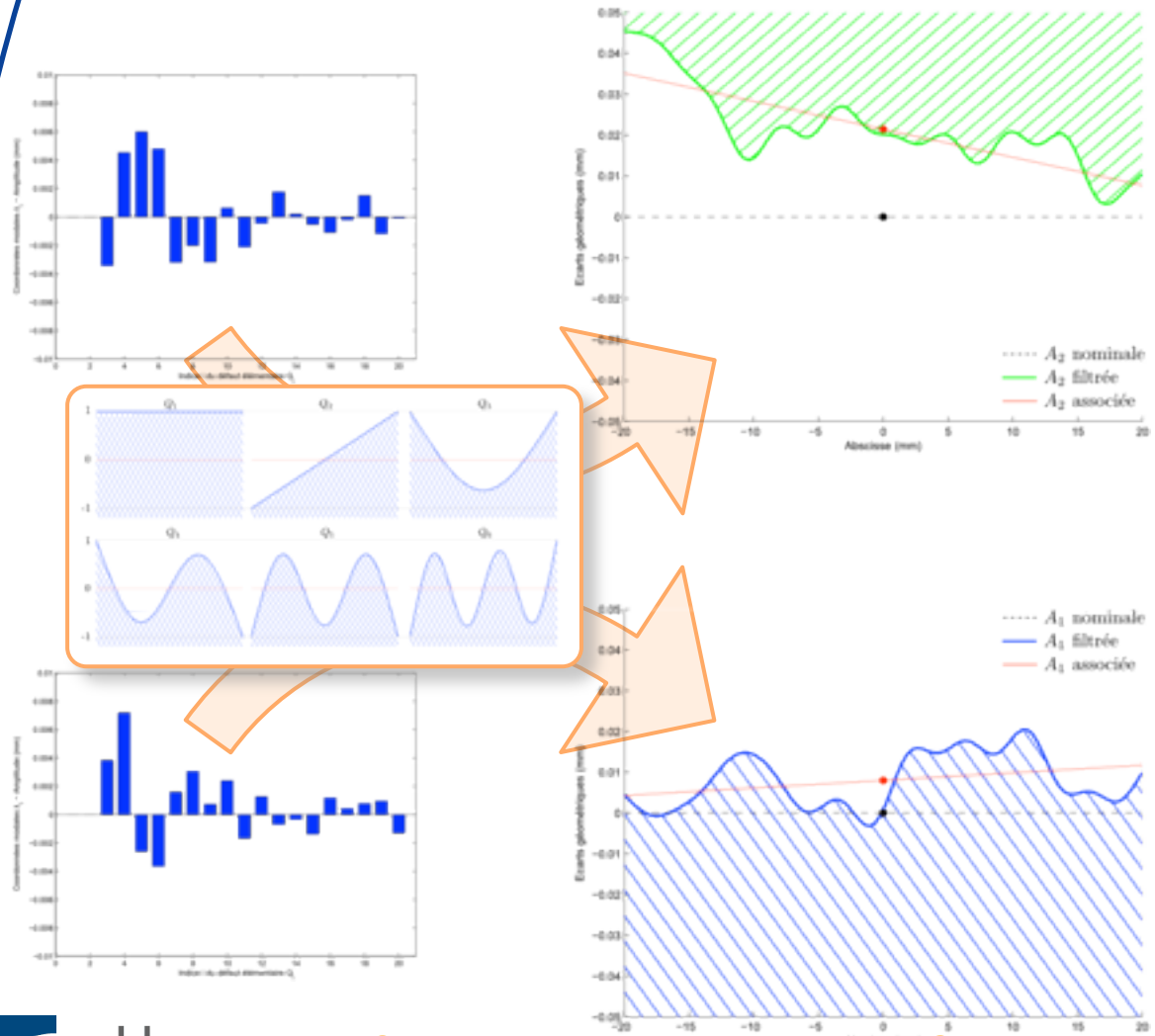

Assembly and form deviations

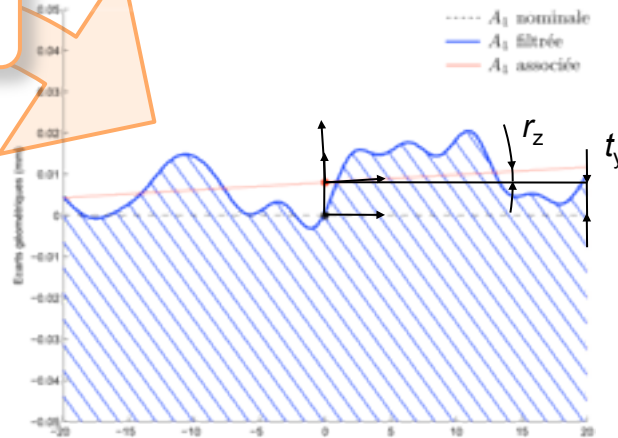
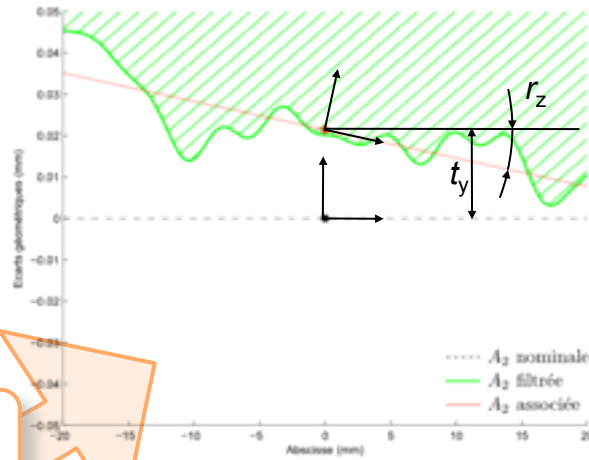
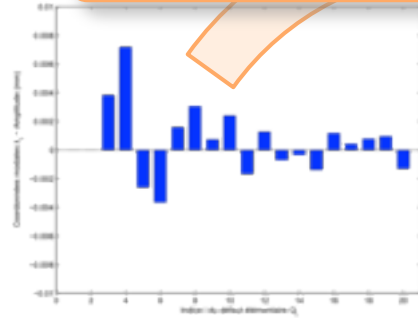
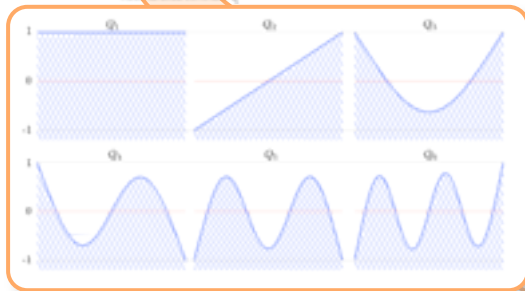
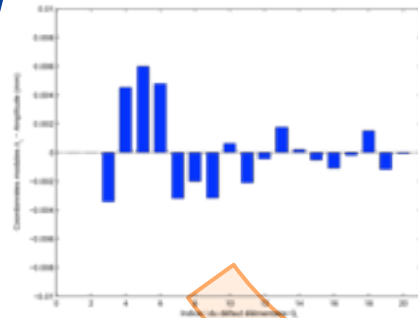

Assembly and form deviations

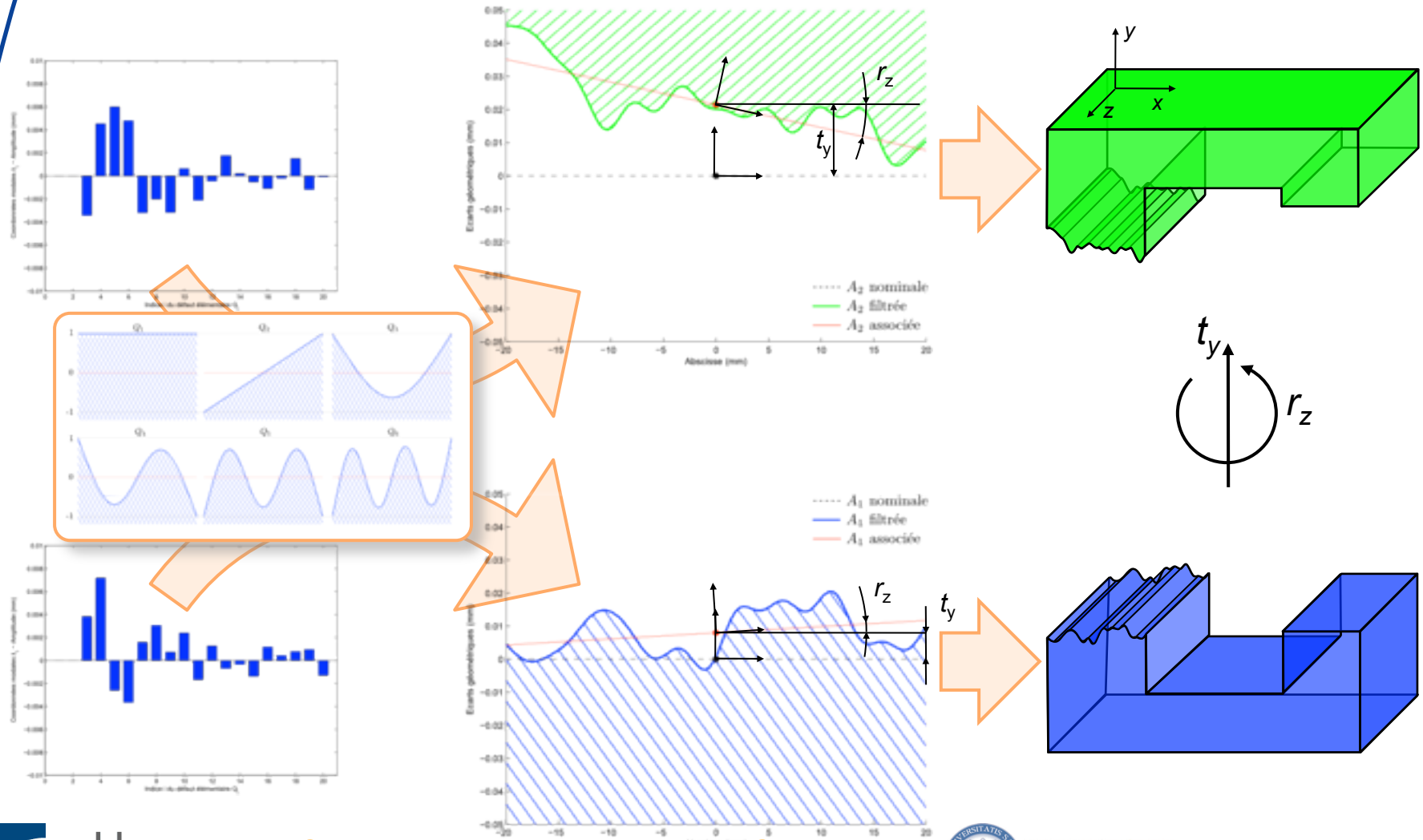

Assembly of rigid deviations only (without form deviations)

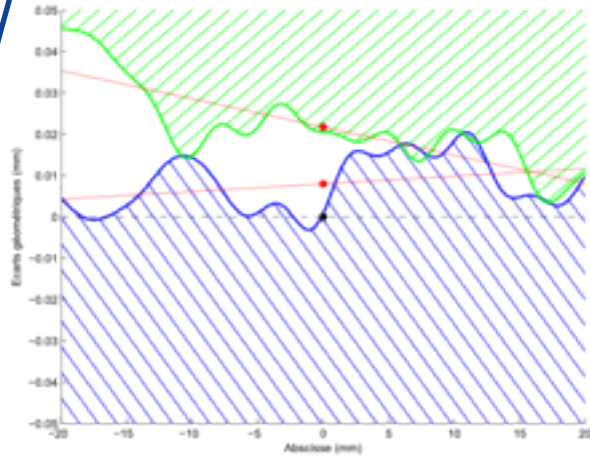

Assembly of rigid deviations only (without form deviations)

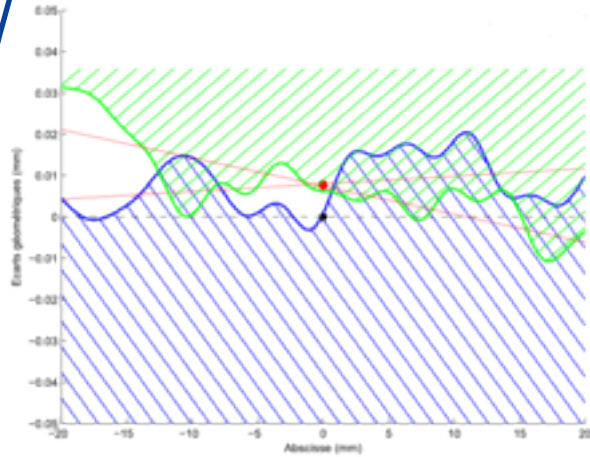

Assembly of rigid deviations only (without form deviations)

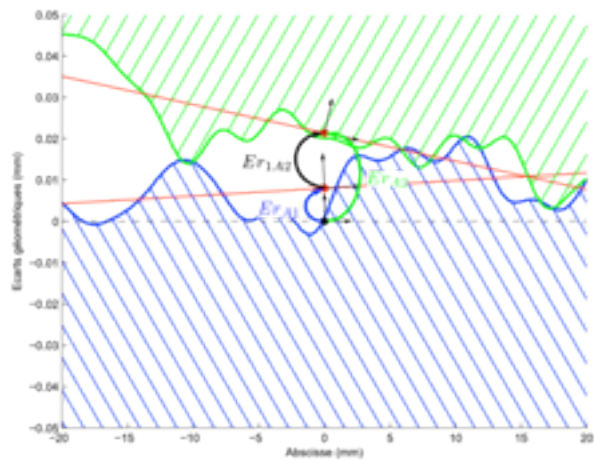
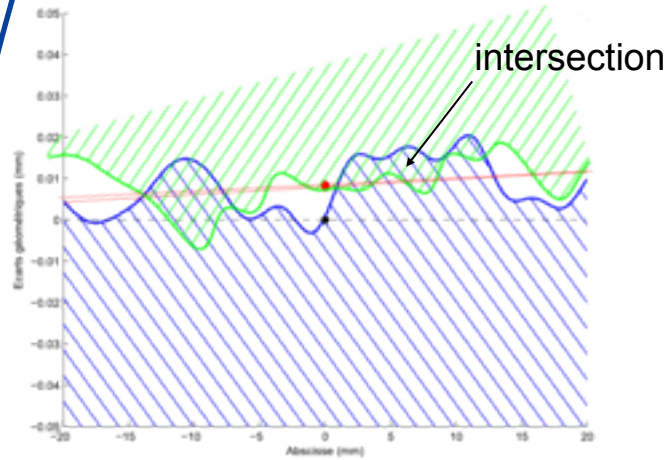

Assembly of rigid deviations only (without form deviations)

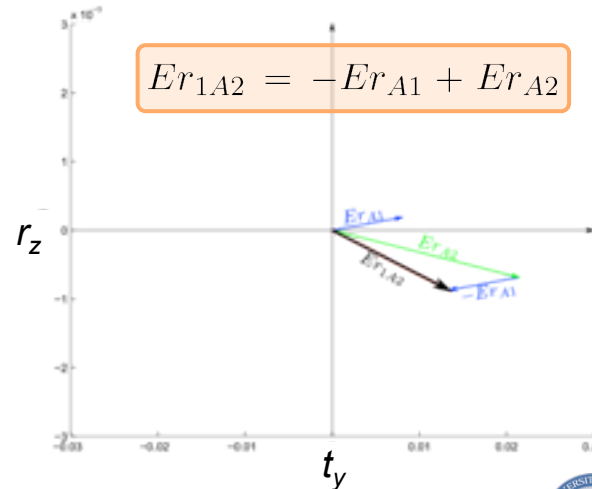
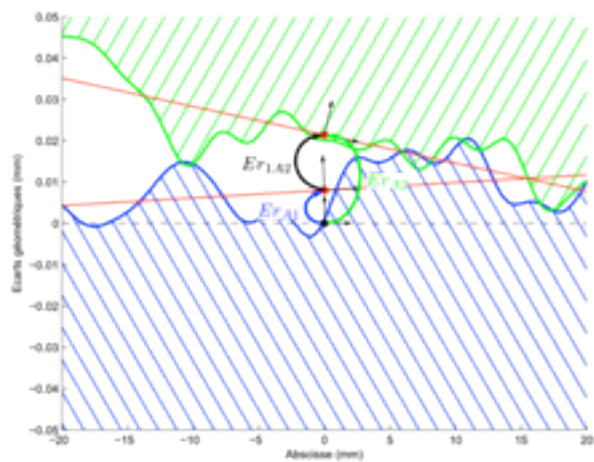
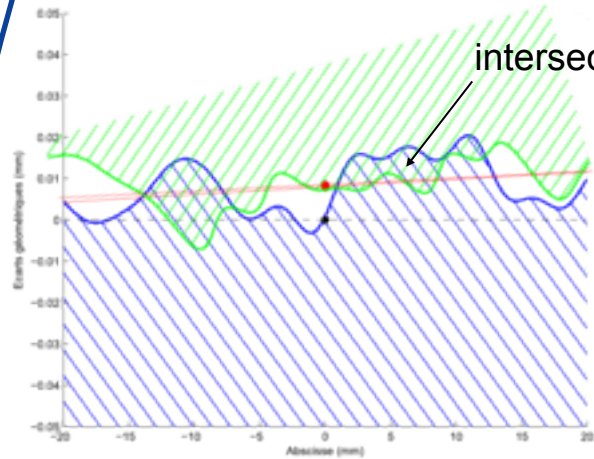

Assembly of rigid deviations only (without form deviations)

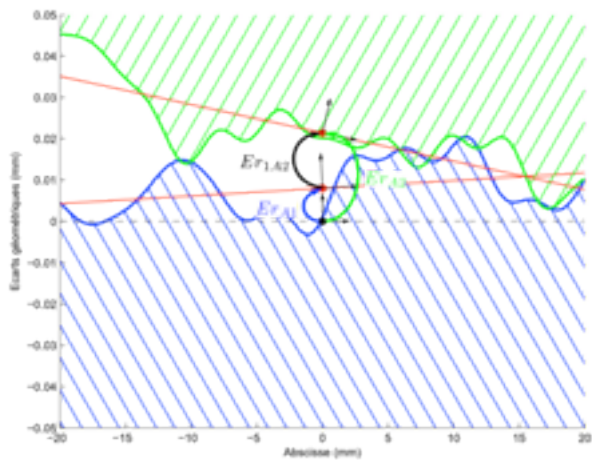
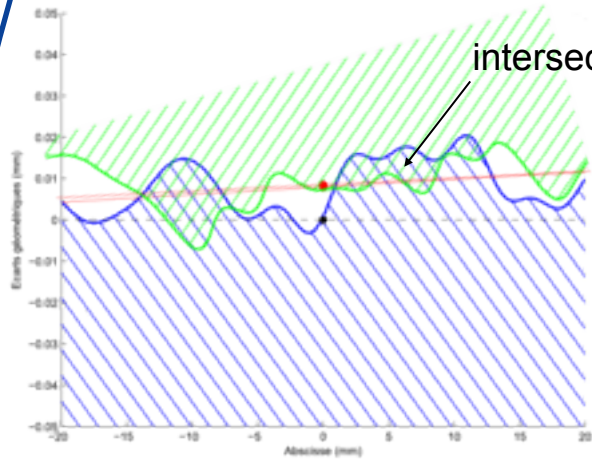

$$\begin{cases} -\frac{t}{2} \leq t_y - \frac{L_{Bx}}{2} r_z \leq \frac{t}{2} \\ -\frac{t}{2} \leq t_y + \frac{L_{Bx}}{2} r_z \leq \frac{t}{2} \end{cases}$$

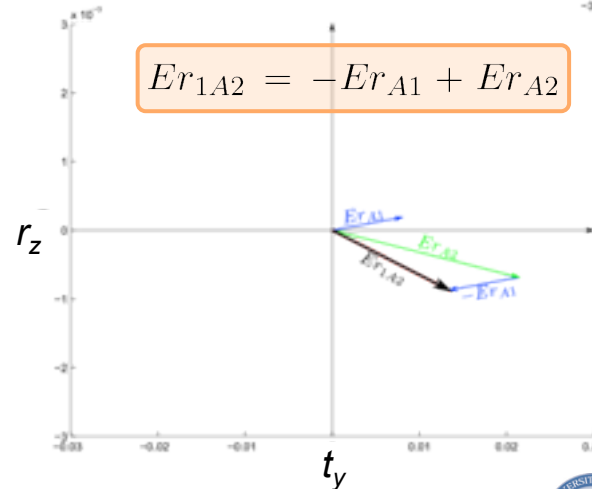
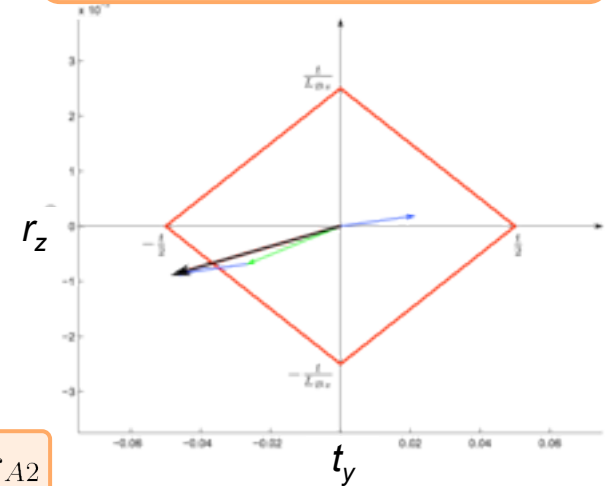

At the functional requirement

Assembly of form deviations only (without rigid deviations)

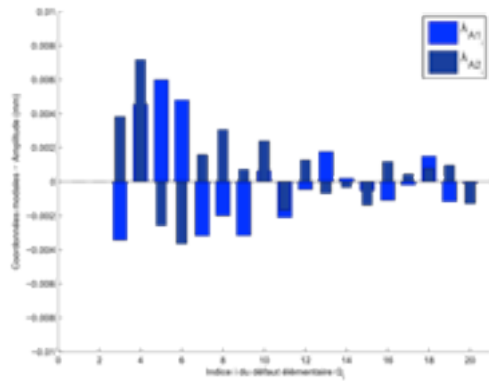

Assembly of form deviations only (without rigid deviations)

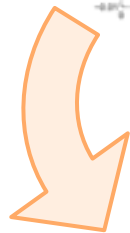
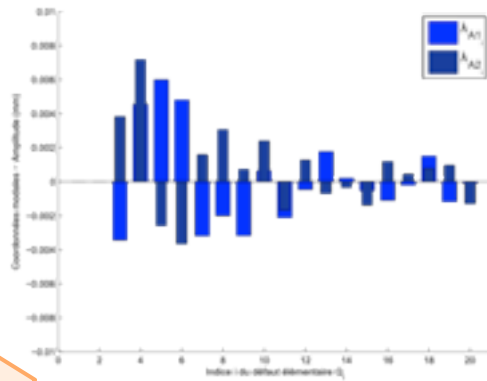

$$\lambda_{1A2_i} = \lambda_{A2_i} - \lambda_{A1_i}$$

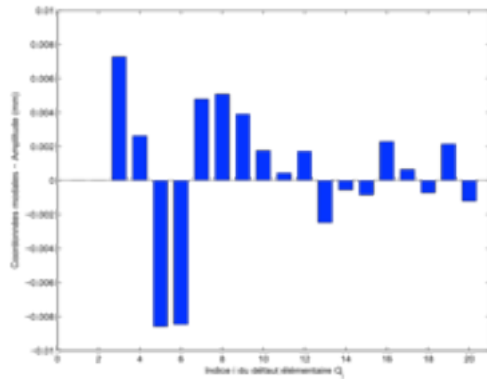

Assembly of form deviations only (without rigid deviations)

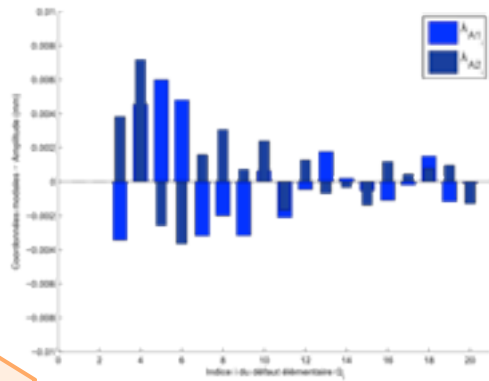

$$\lambda_{1A2_i} = \lambda_{A2_i} - \lambda_{A1_i}$$

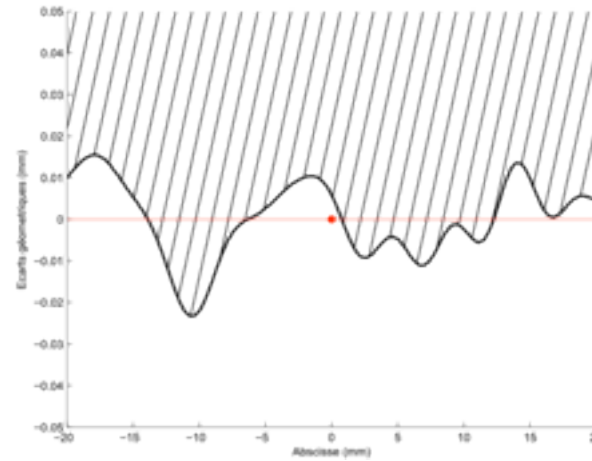
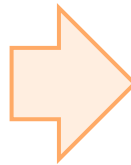
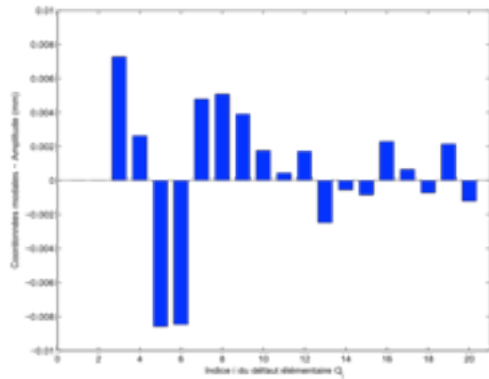

Assembly of form deviations only (without rigid deviations)

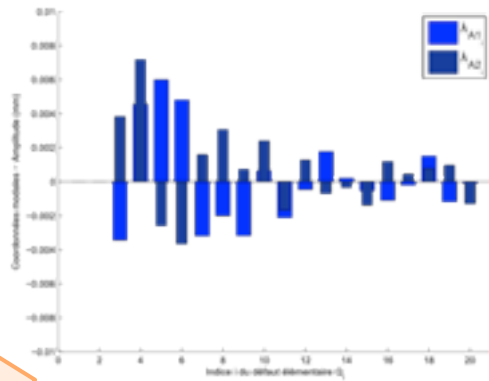

$$\lambda_{1A2_i} = \lambda_{A2_i} - \lambda_{A1_i}$$

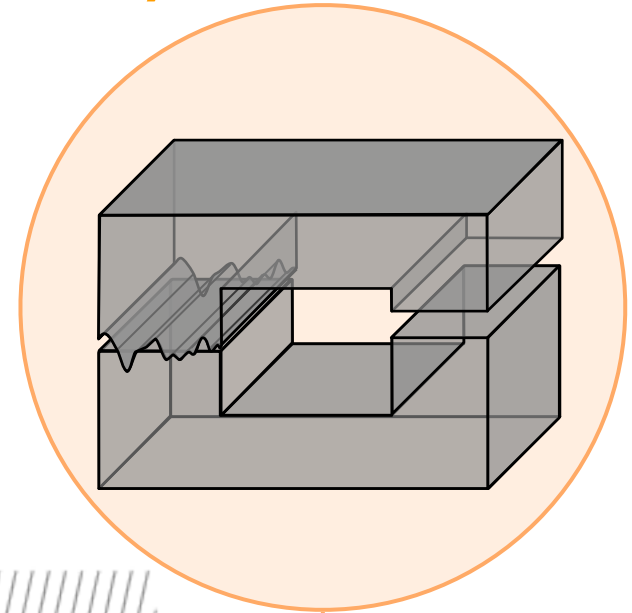
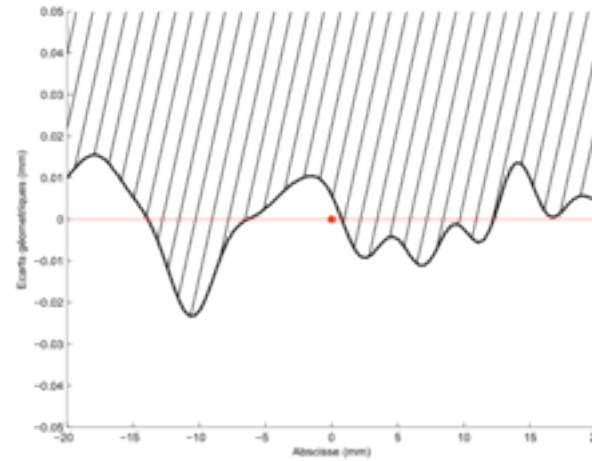
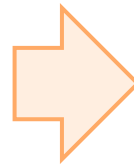
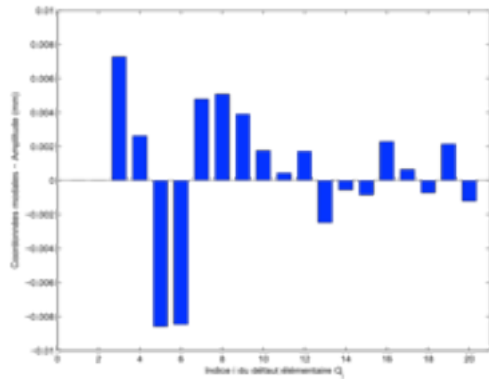

Assembly of form deviations only (without rigid deviations)

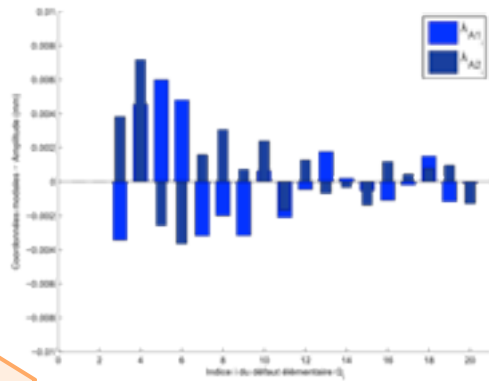

$$\lambda_{1A2_i} = \lambda_{A2_i} - \lambda_{A1_i}$$

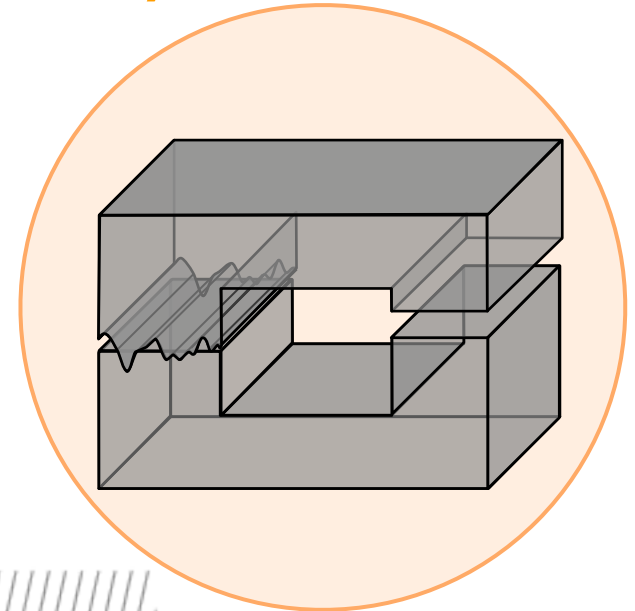
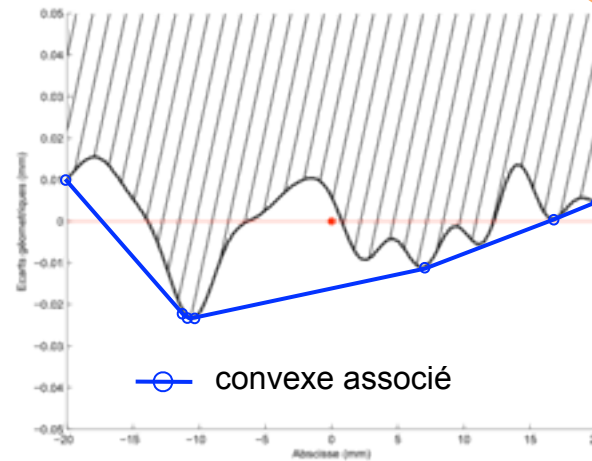
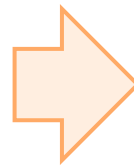
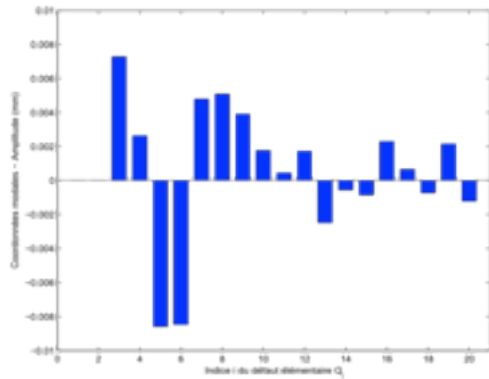

Assembly of rigid and form deviations

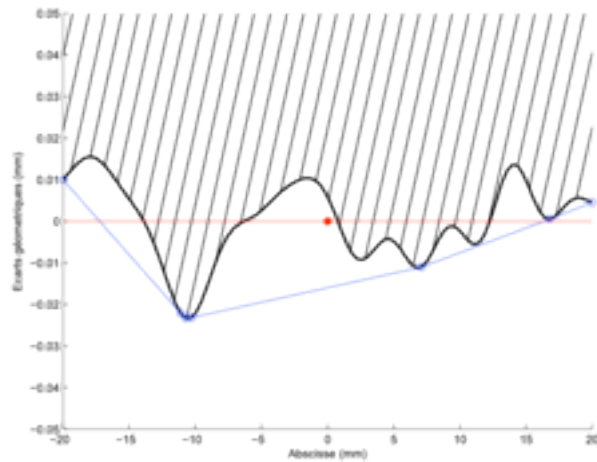

Assembly of rigid and form deviations

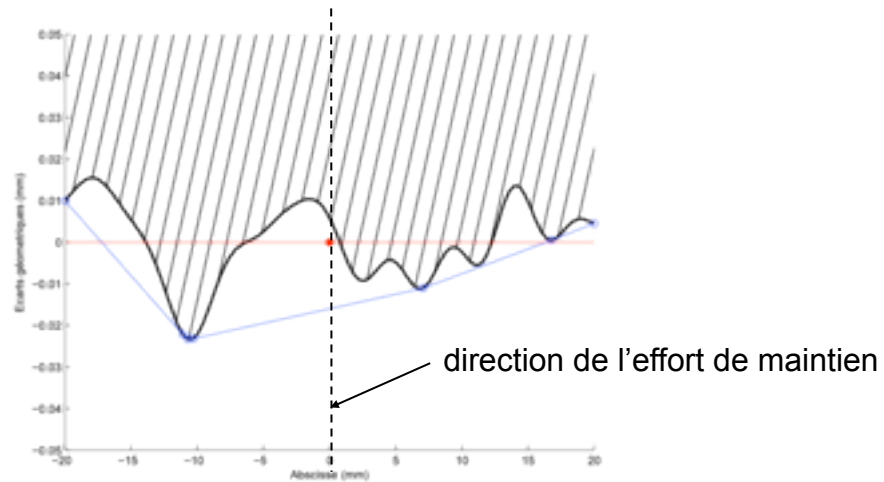

Assembly of rigid and form deviations

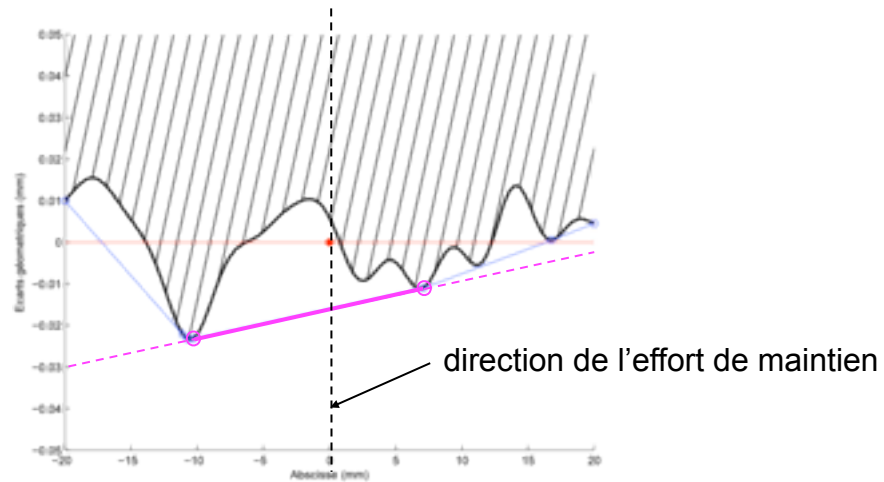

Assembly of rigid and form deviations

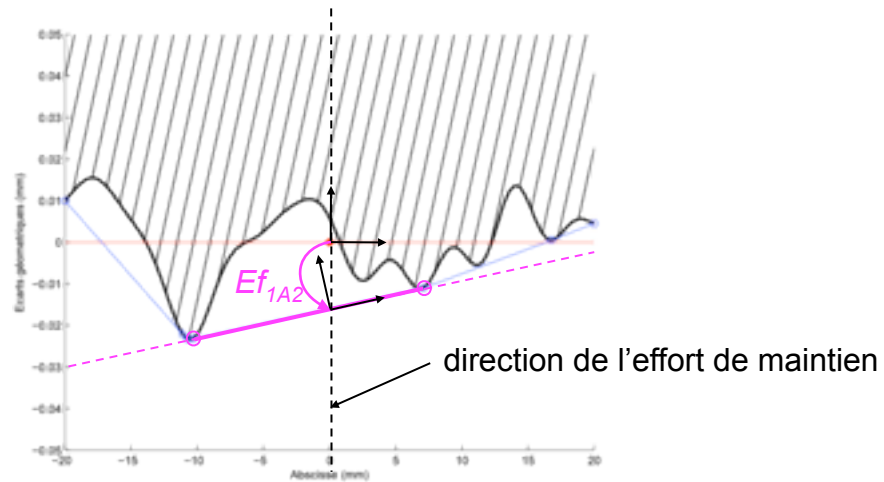

Assembly of rigid and form deviations

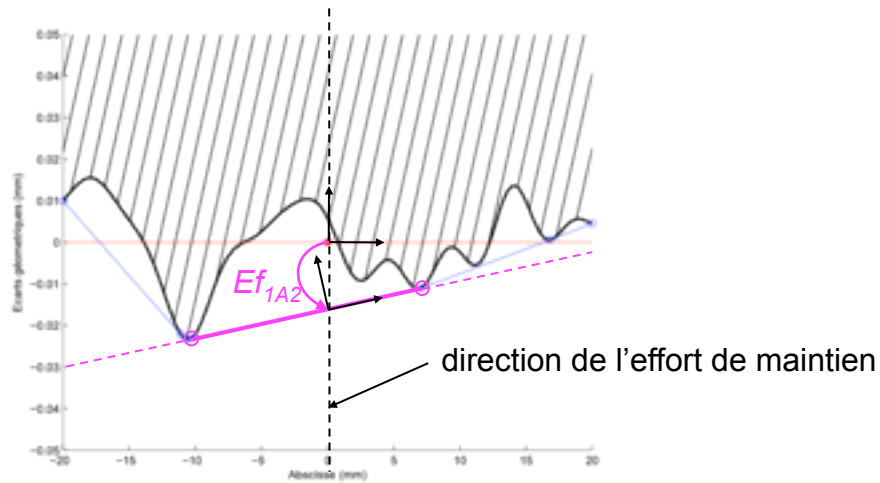

MIP sur la
facette

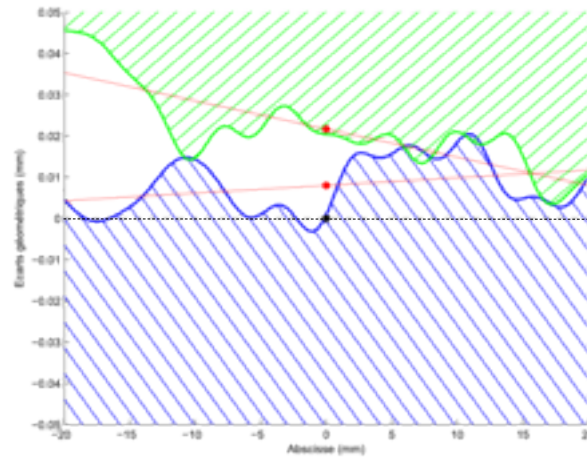

Assembly of rigid and form deviations

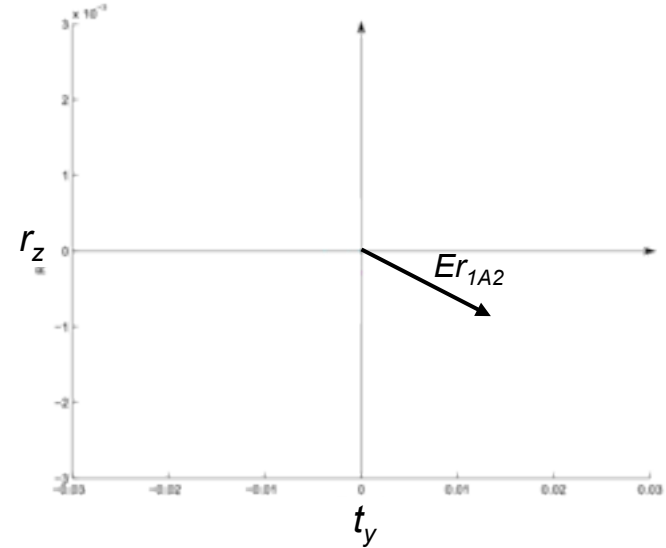
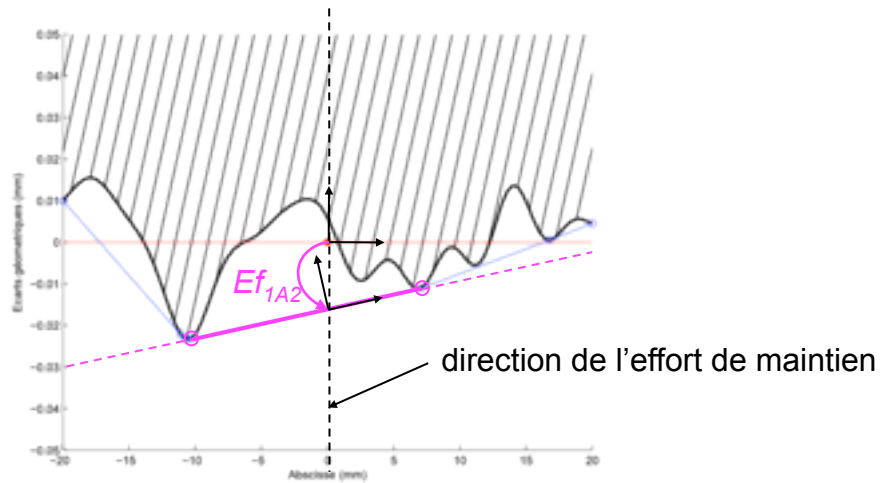

MIP sur la facette

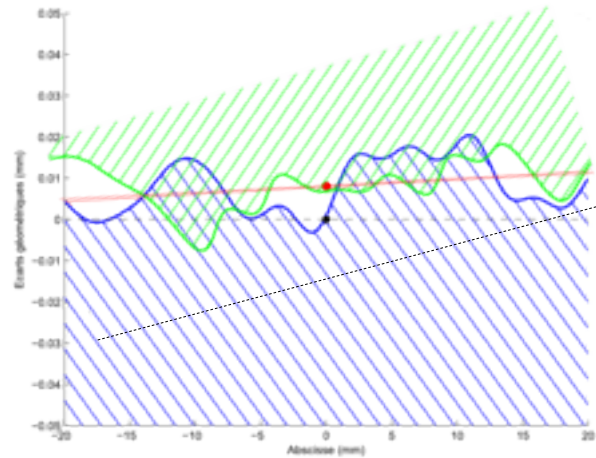

Assembly of rigid and form deviations

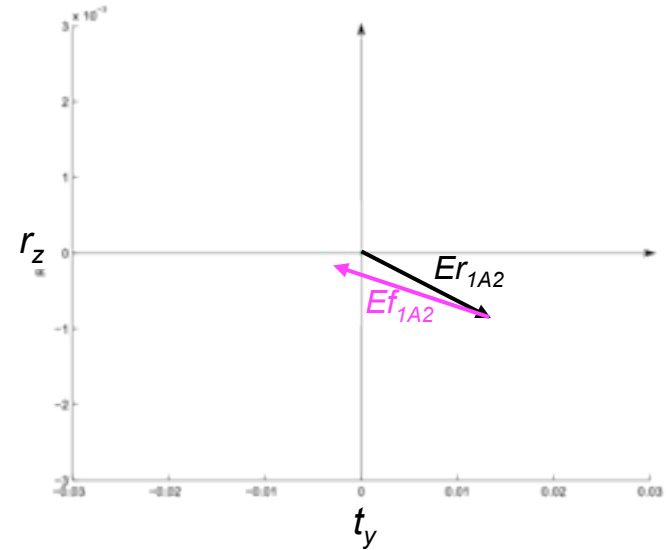
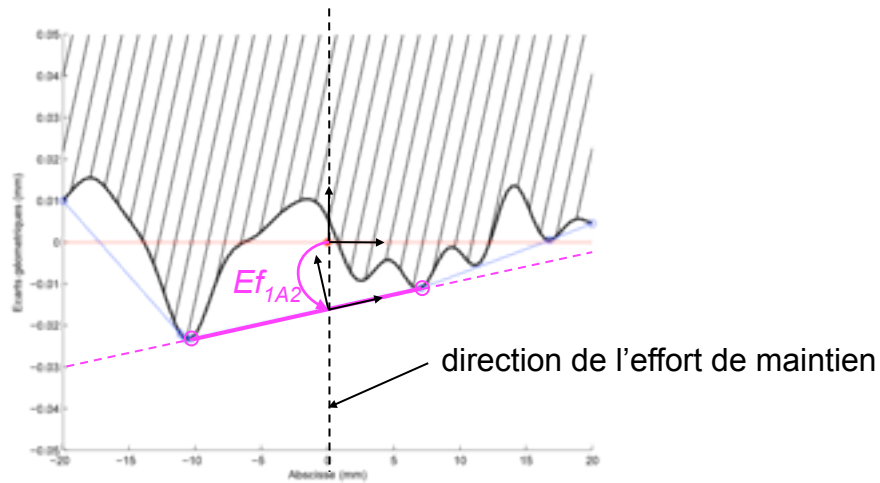

MIP sur la facette

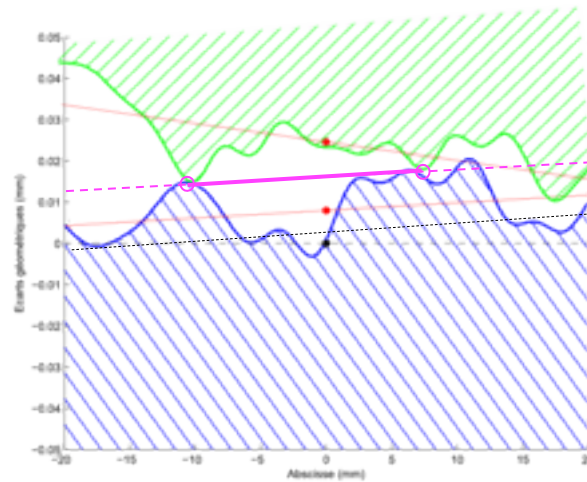

Assembly of rigid and form deviations

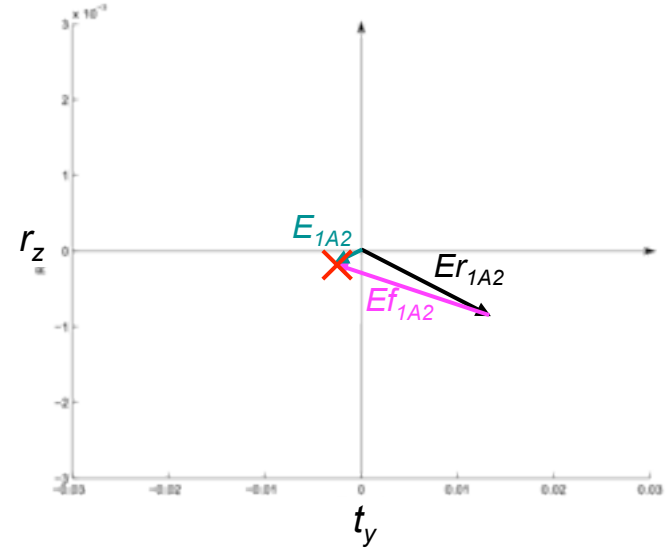
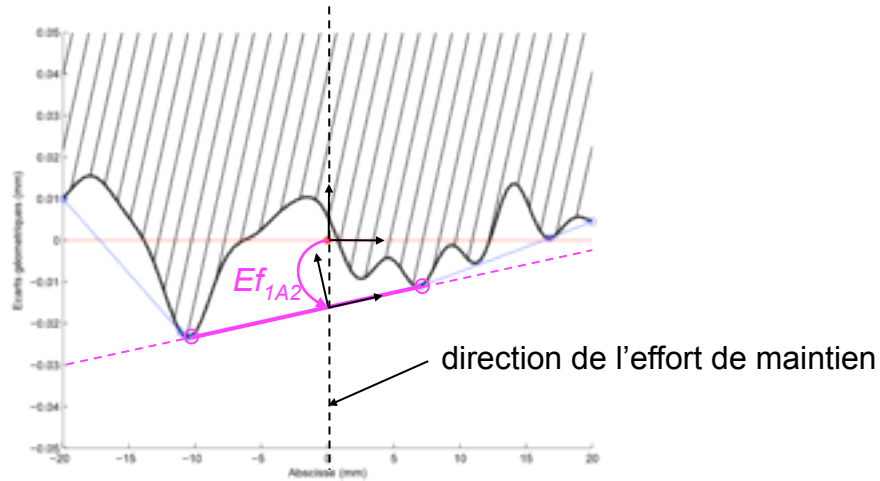

MIP sur la facette

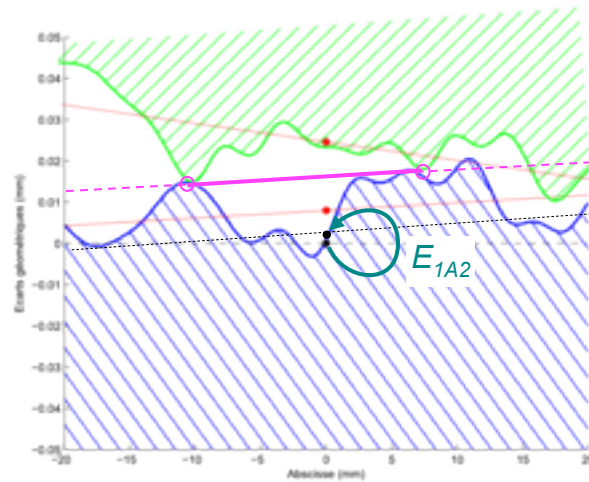

Assembly of rigid and form deviations

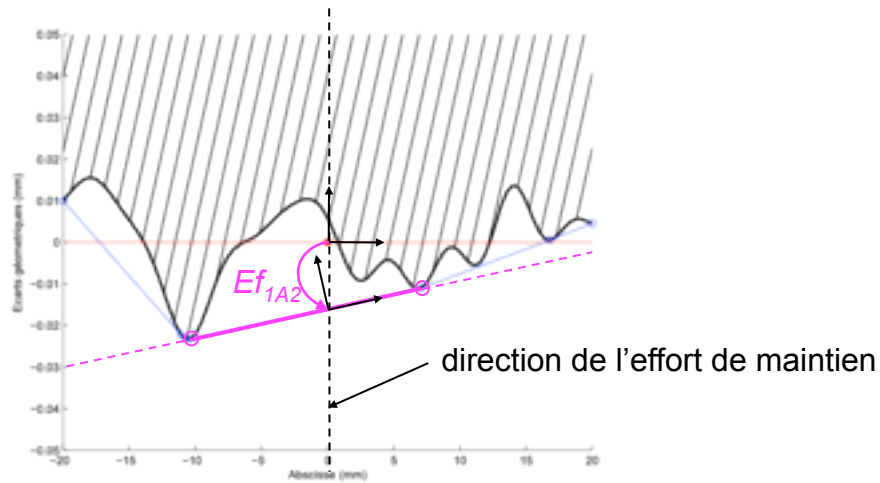

MIP sur la facette

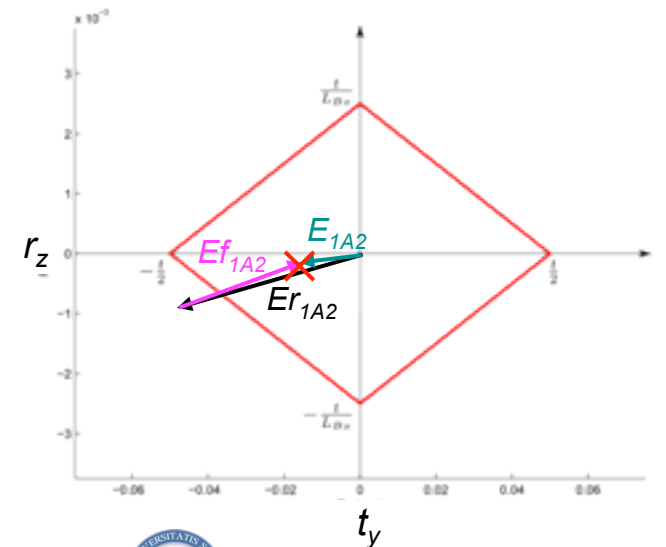
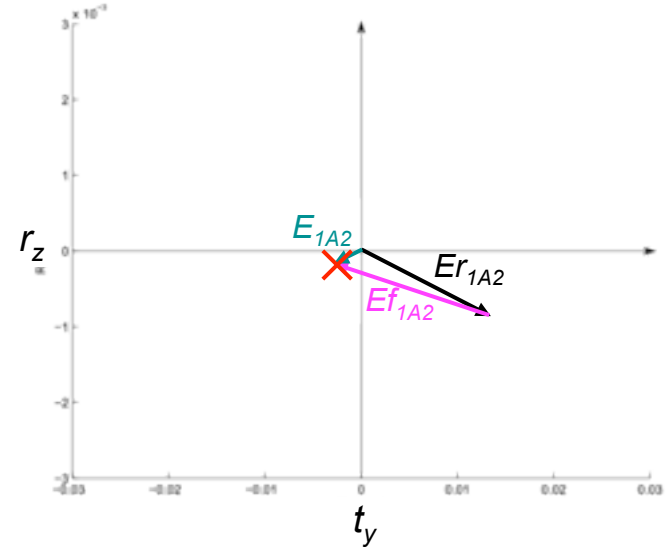
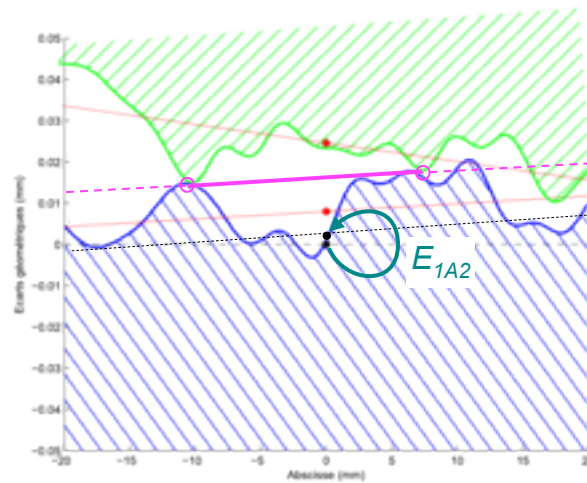



Influence of form deviations in clearance linkage

Clearance and form deviations

Clearance and form deviations

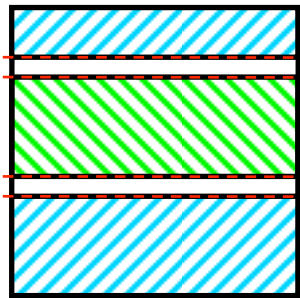

Clearance and form deviations

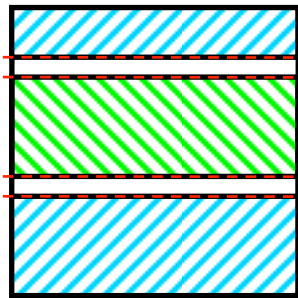
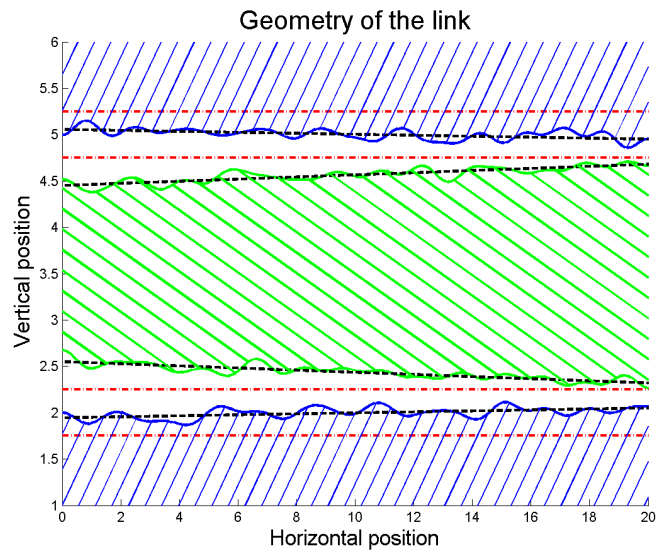

Clearance and form deviations

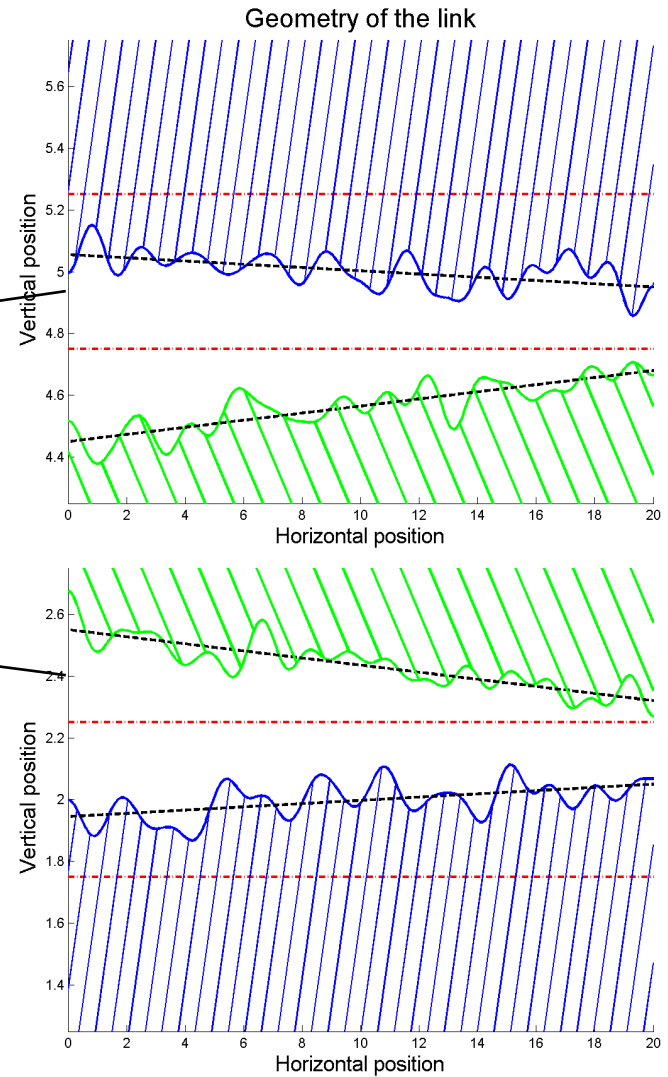
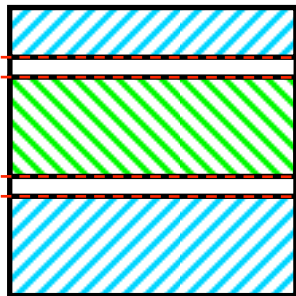
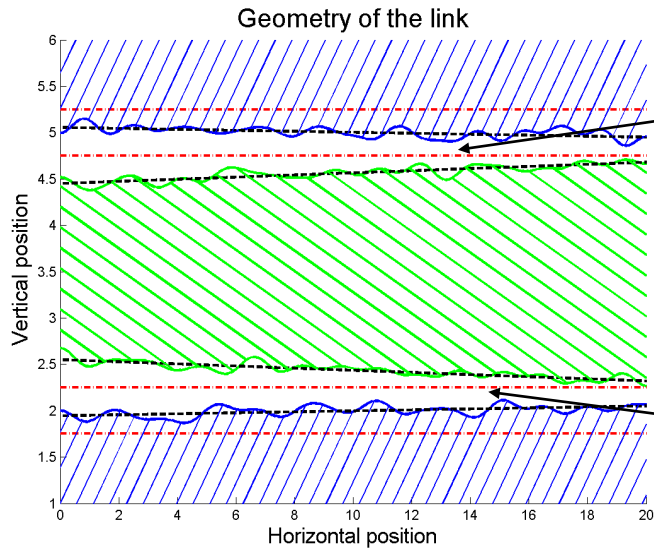

Clearance and form deviations

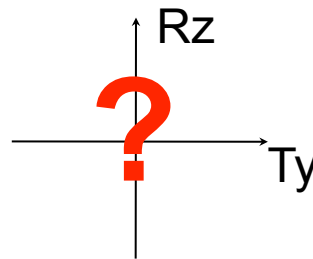
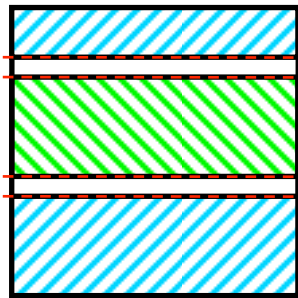
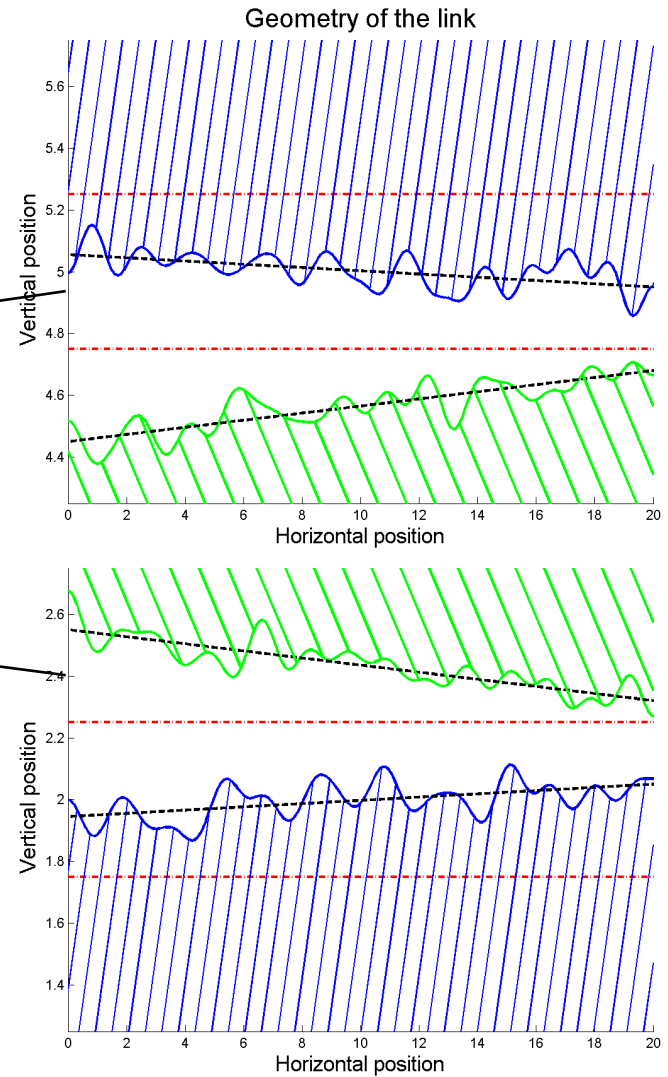
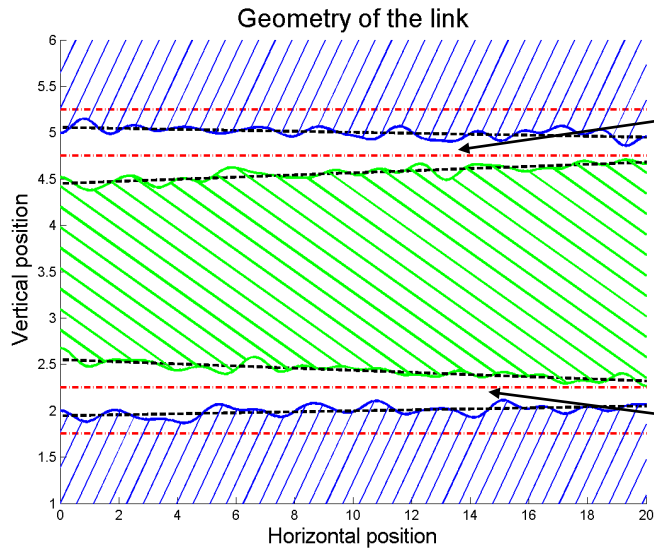

Clearance and form deviations

Clearance and form deviations

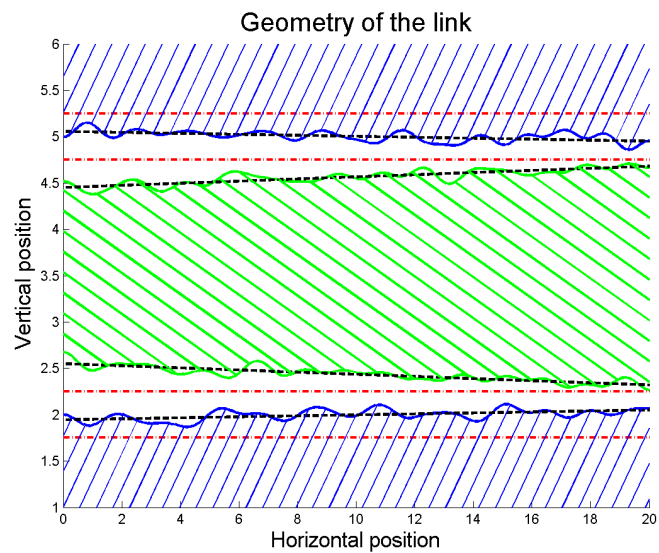

Clearance and form deviations

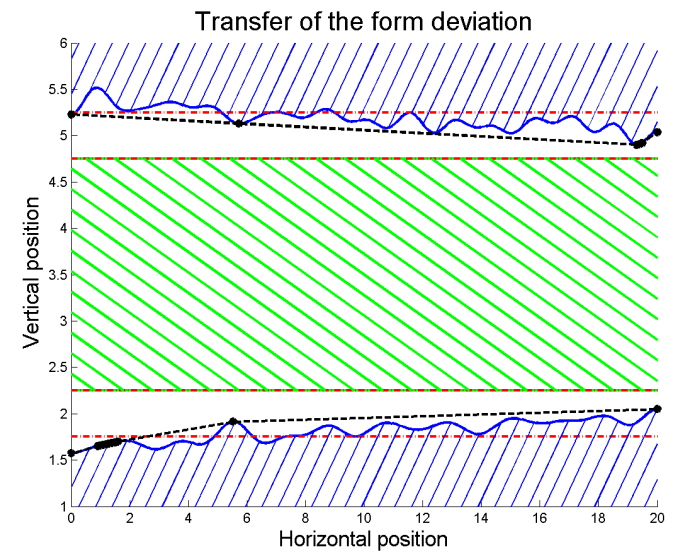
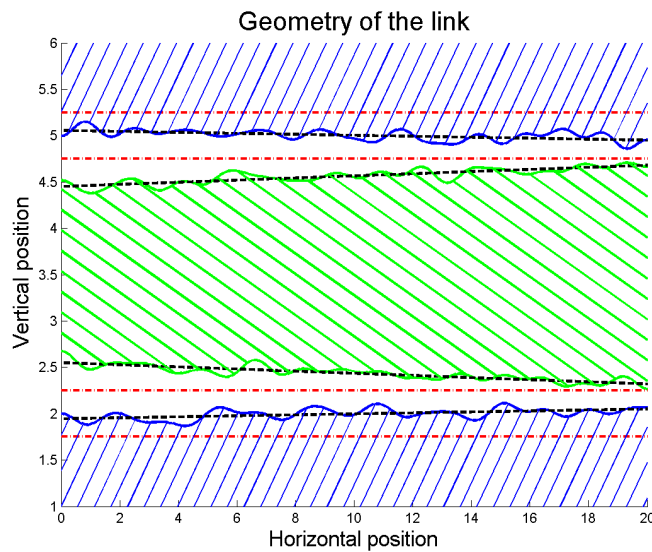

Clearance and form deviations

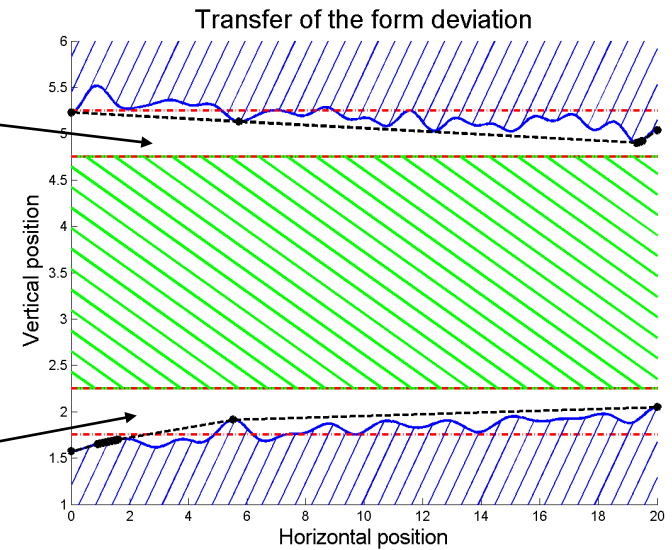
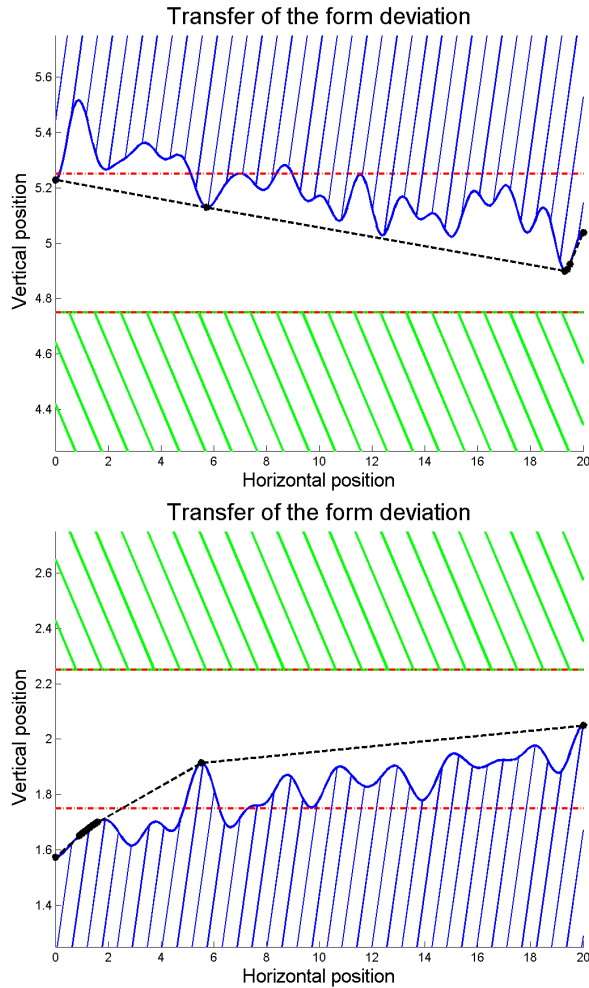

Clearance and form deviations

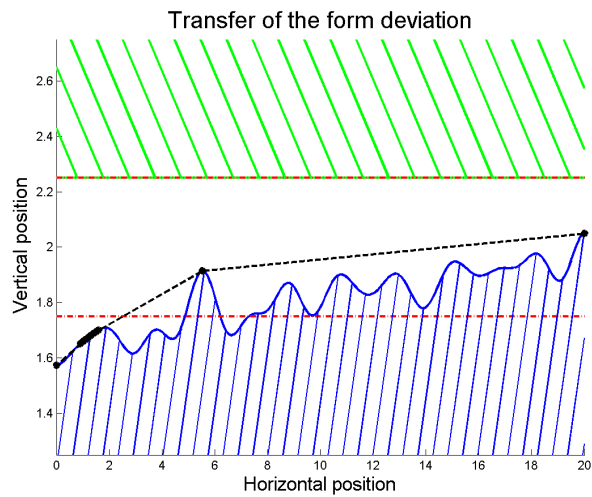
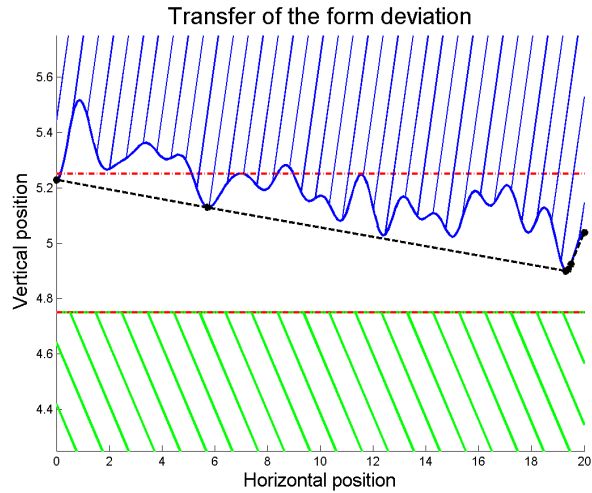

Clearance and form deviations

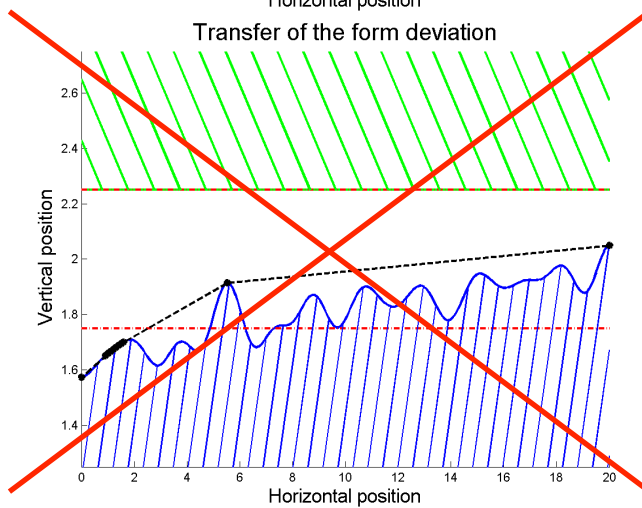
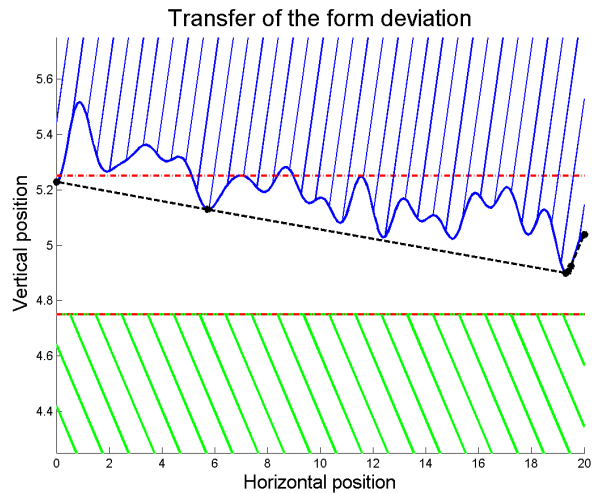

Clearance and form deviations

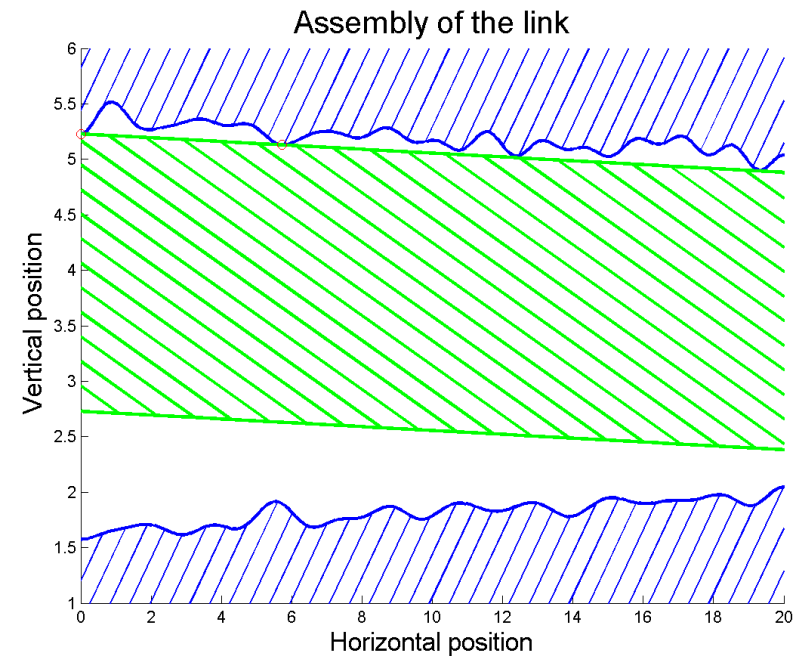
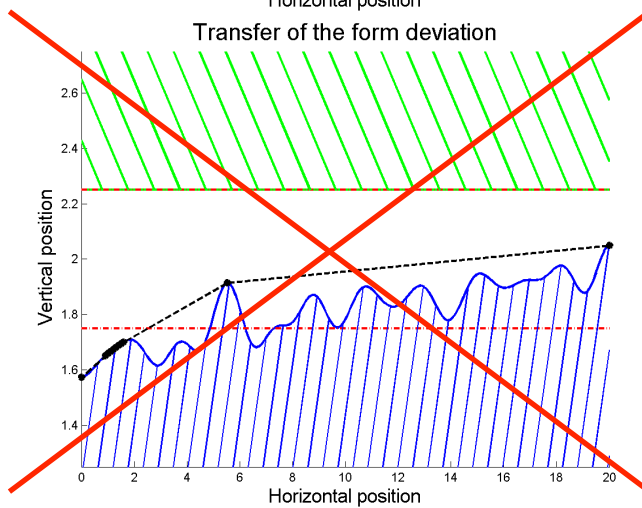
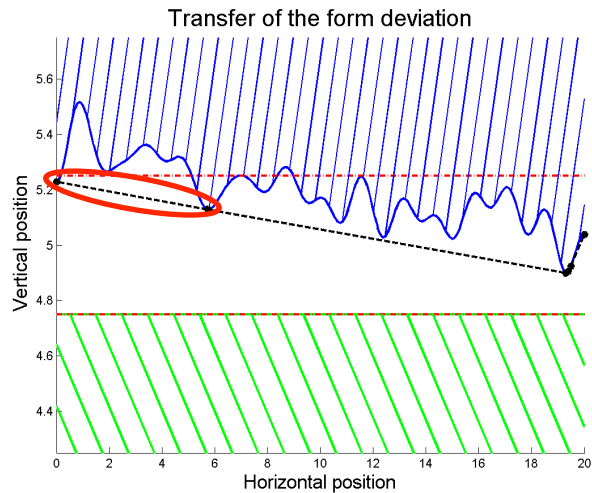

Clearance and form deviations

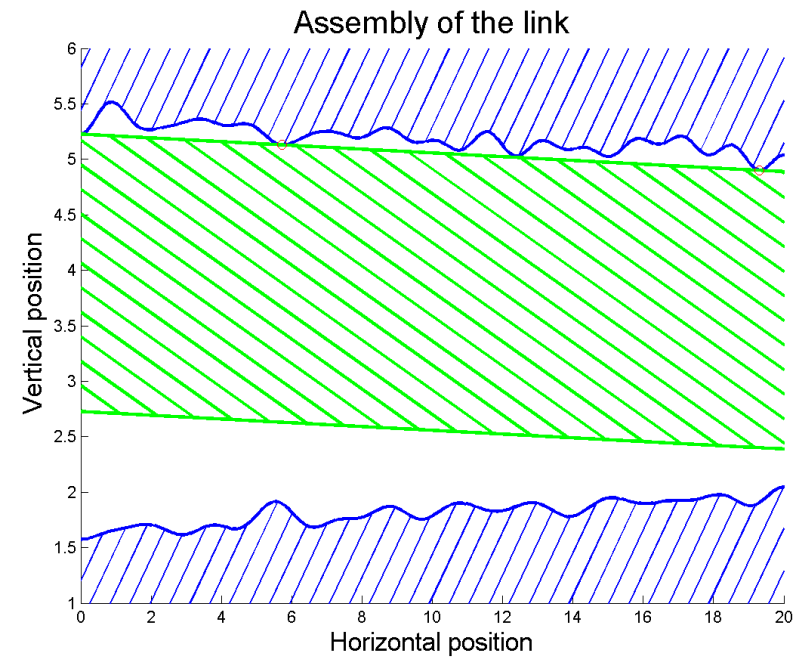
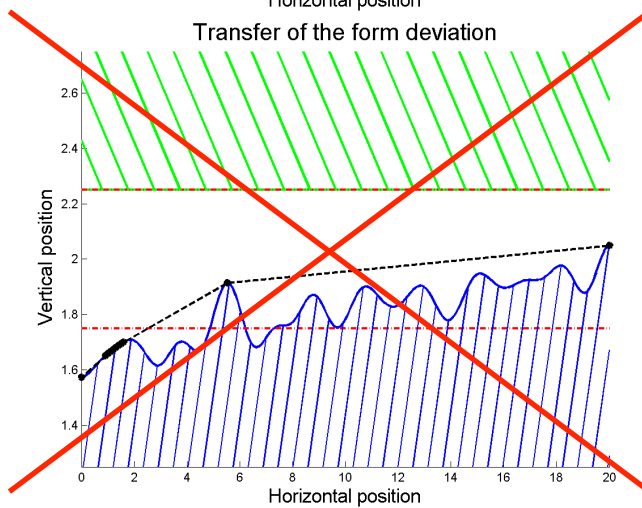
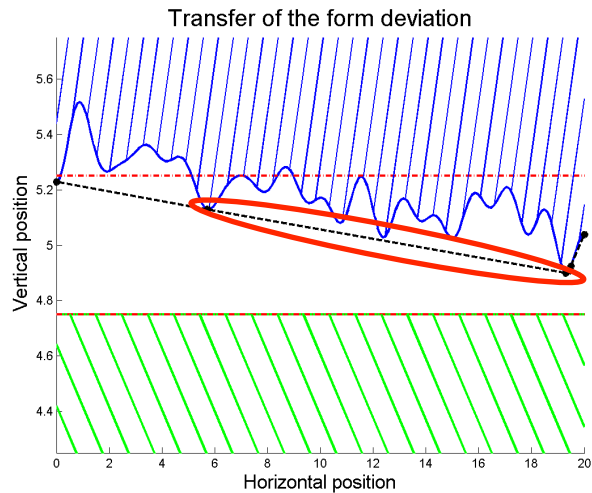

Clearance and form deviations

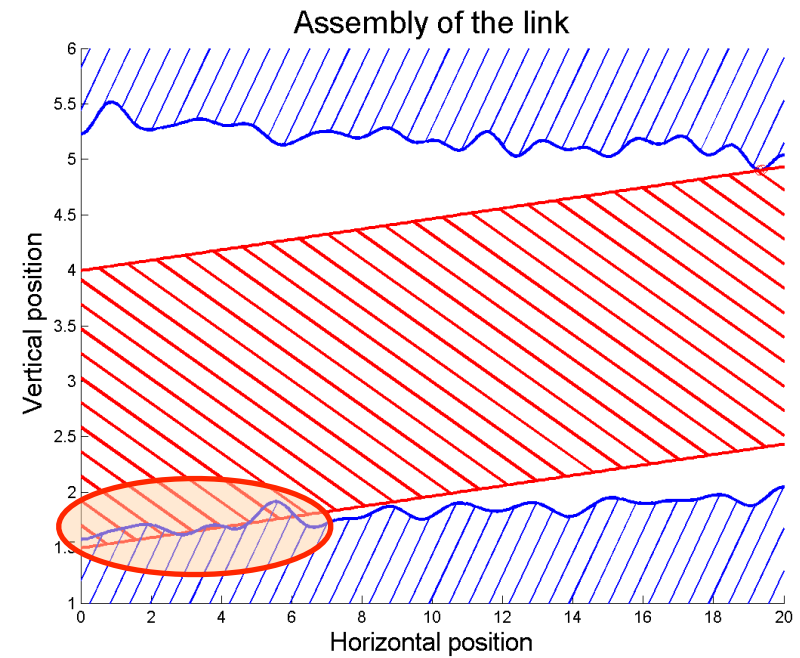
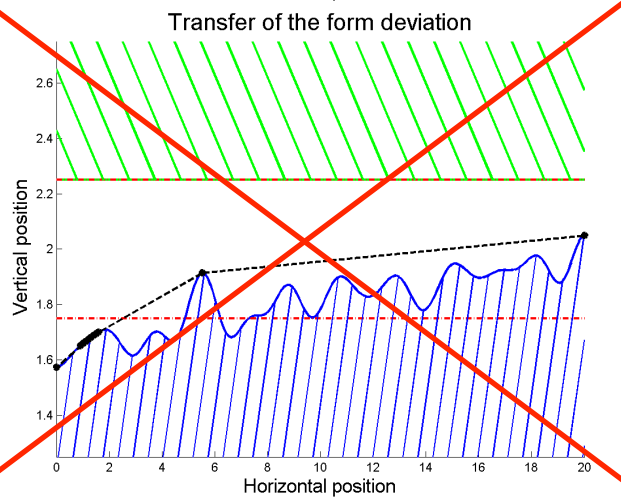
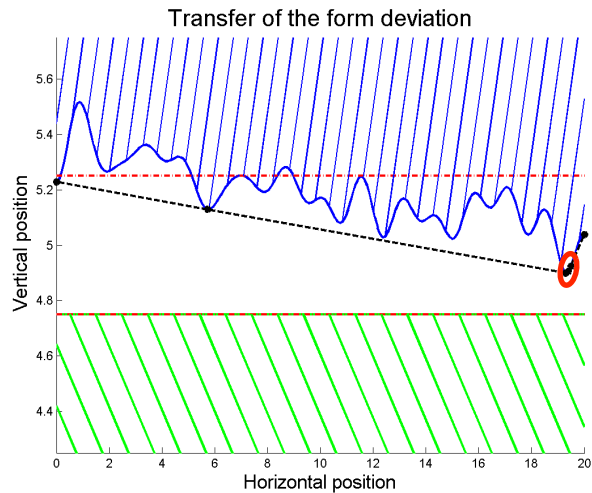

Clearance and form deviations

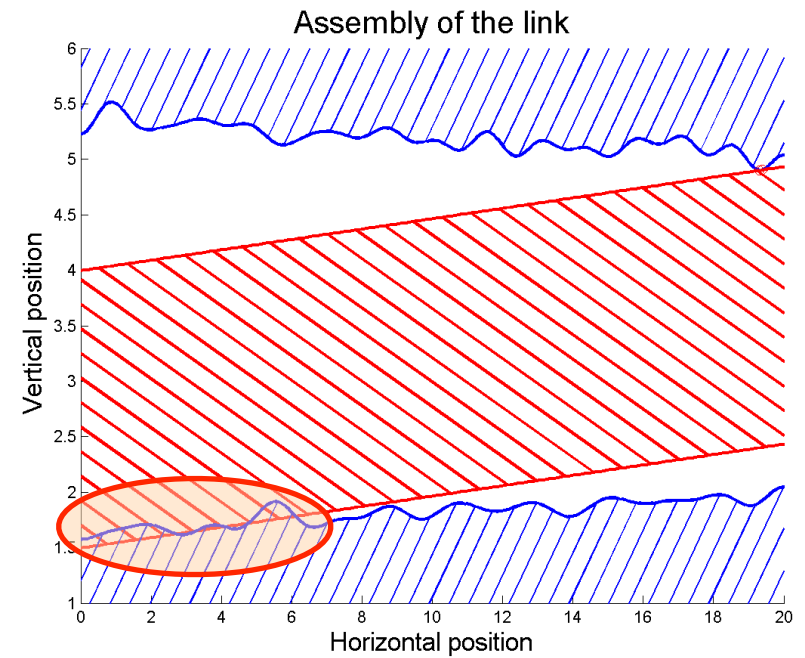
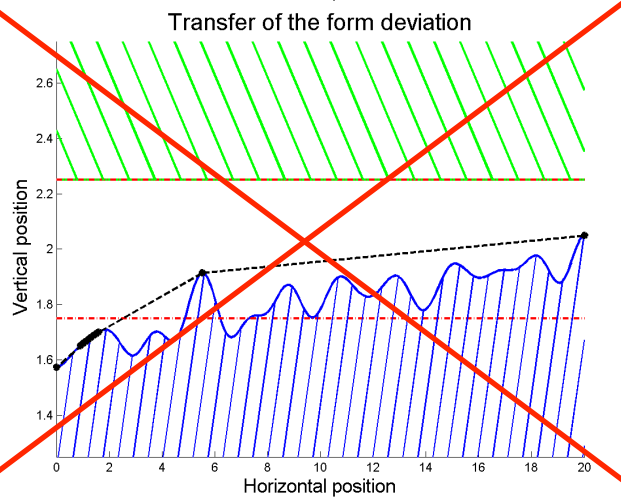
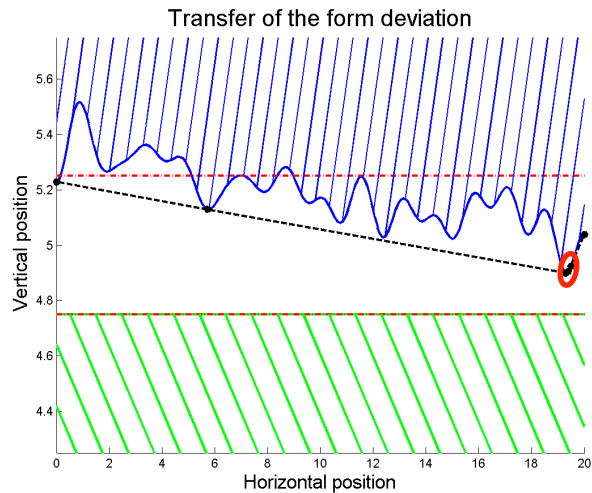

2 positioning

Clearance and form deviations

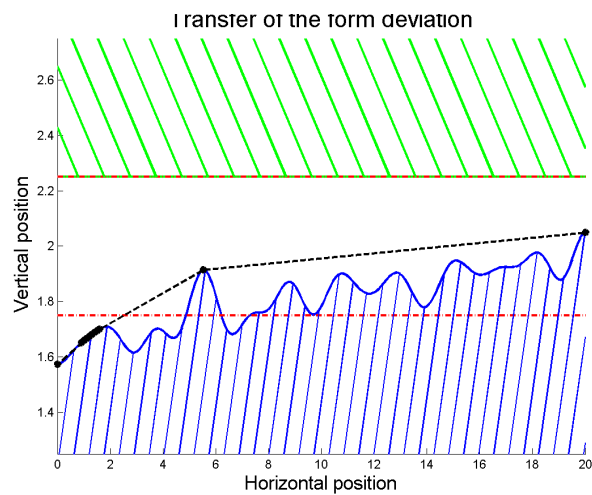
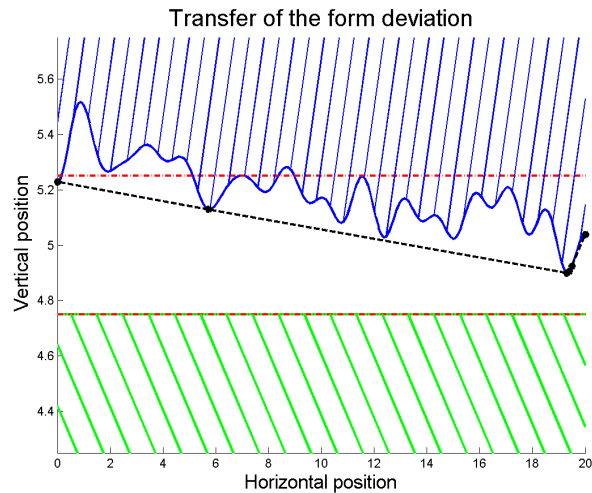

Clearance and form deviations

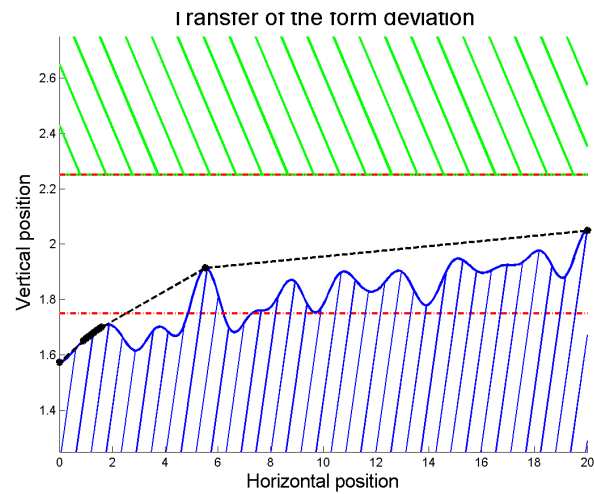
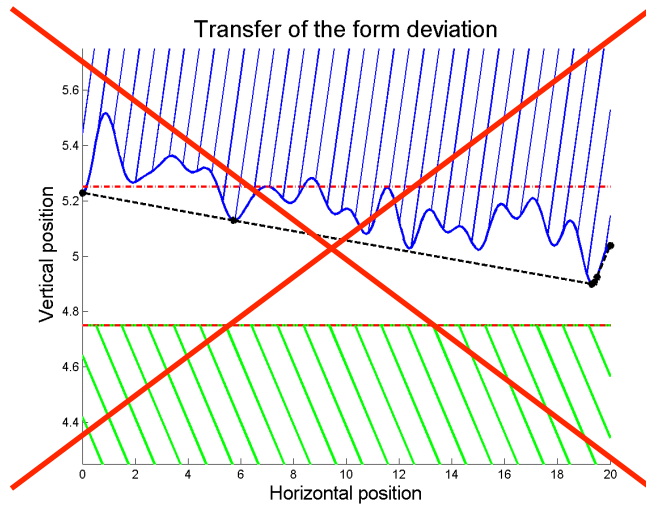

Clearance and form deviations

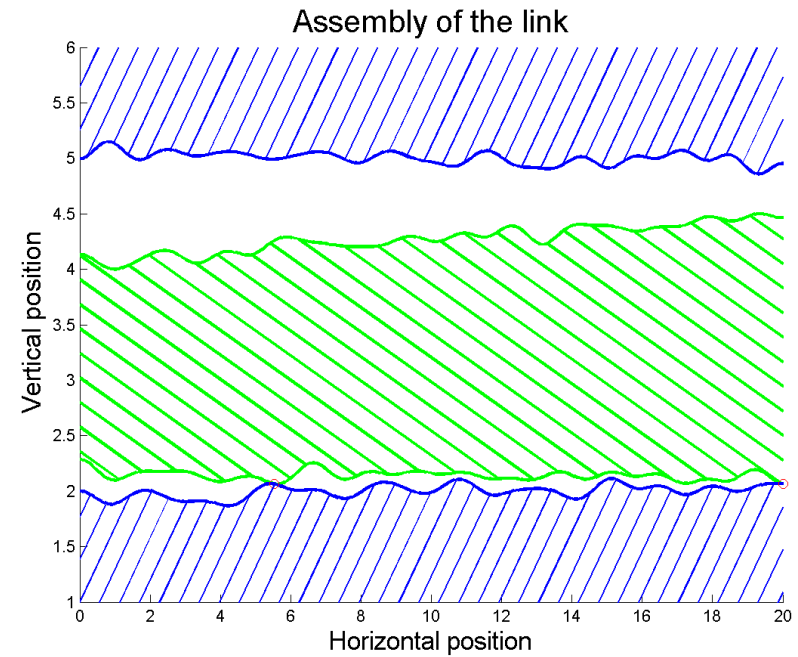
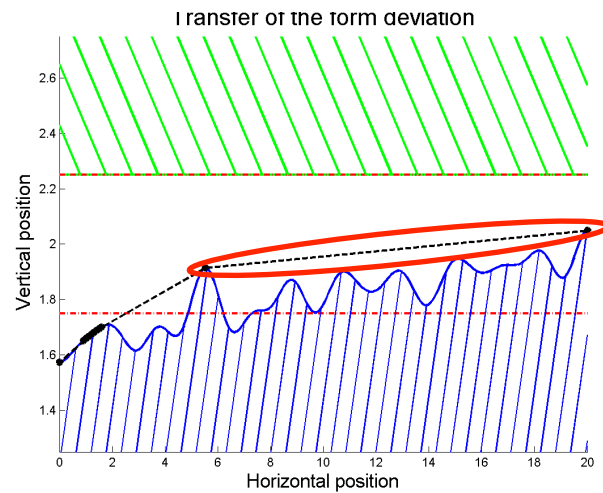
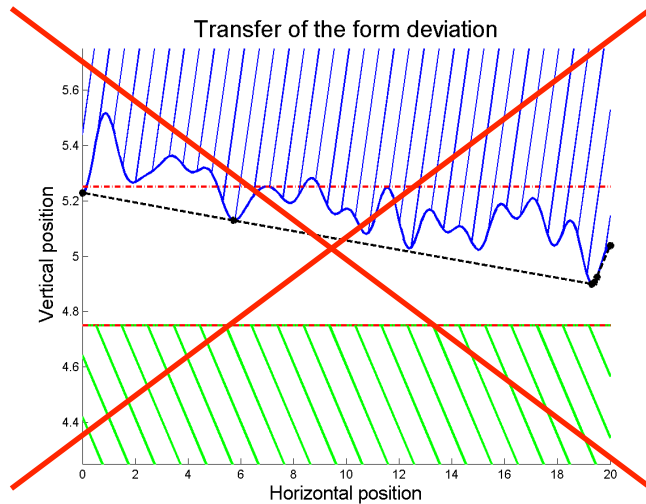

Clearance and form deviations

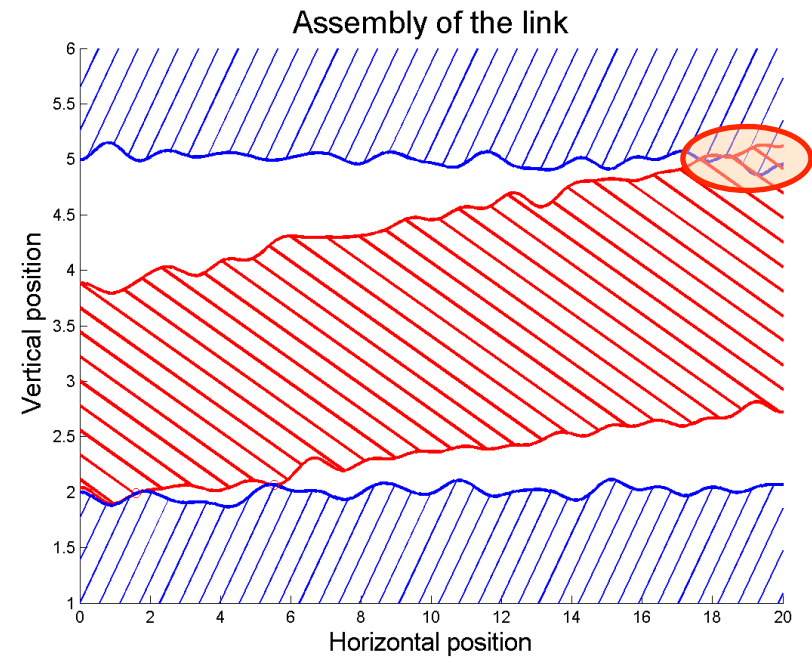
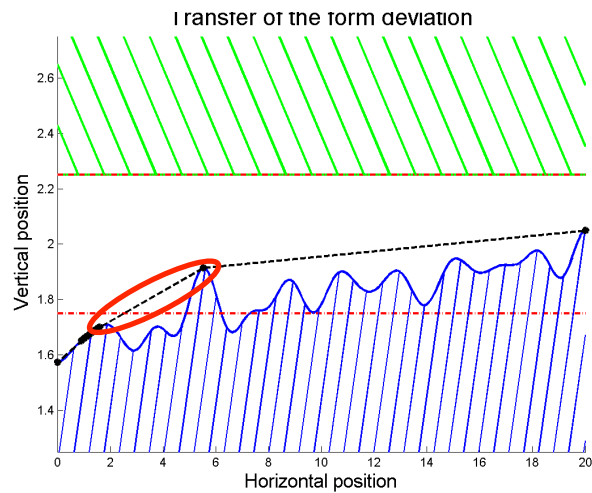
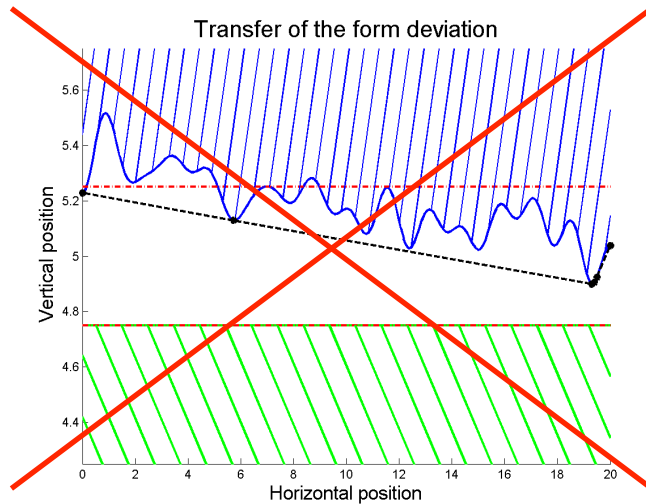

Clearance and form deviations

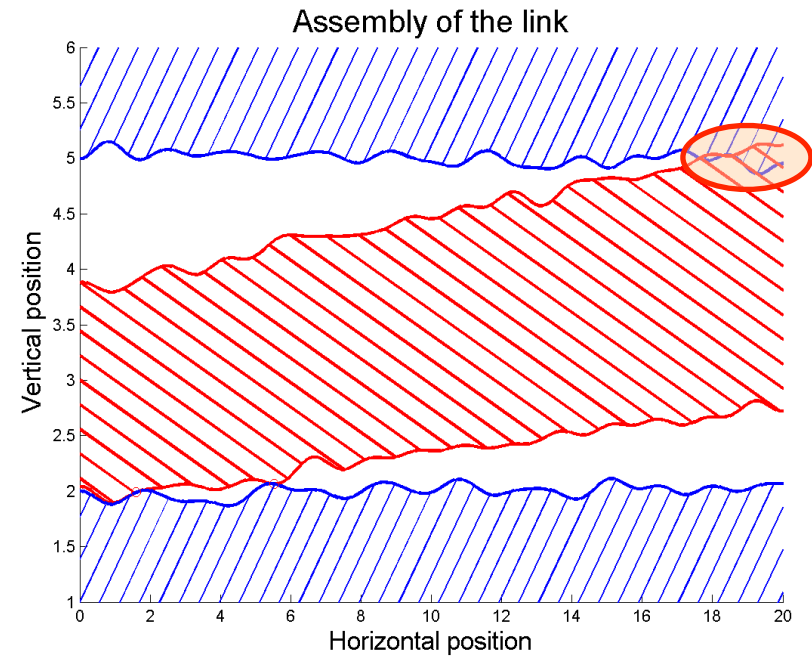
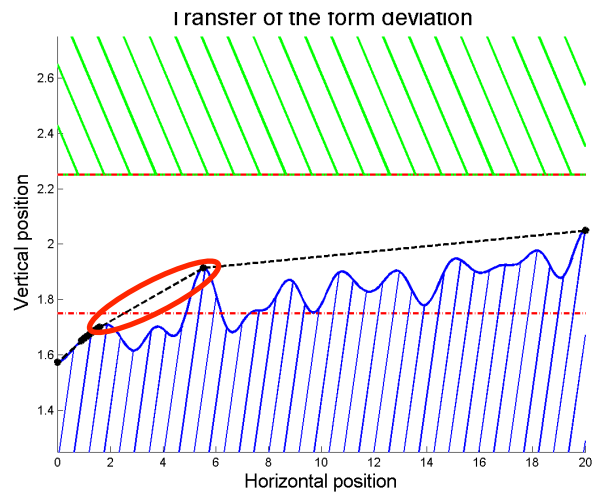
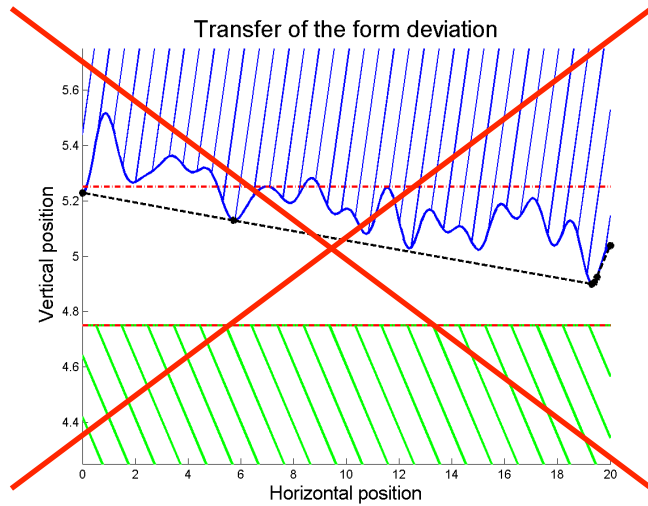

1 positioning

Clearance and form deviations

Clearance and form deviations

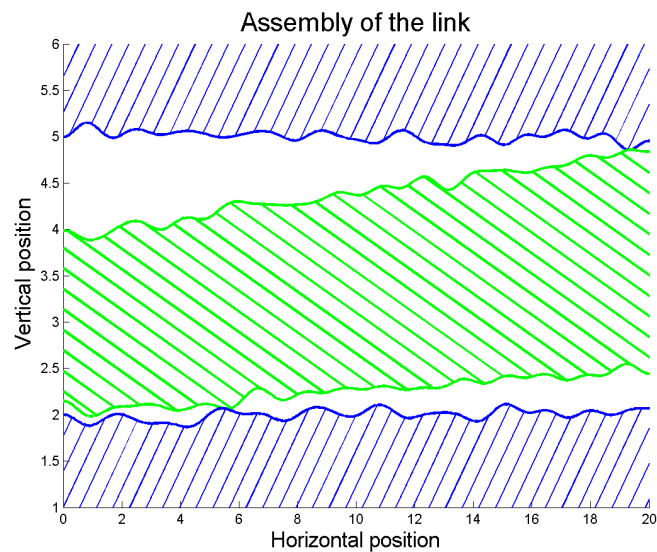

Clearance and form deviations

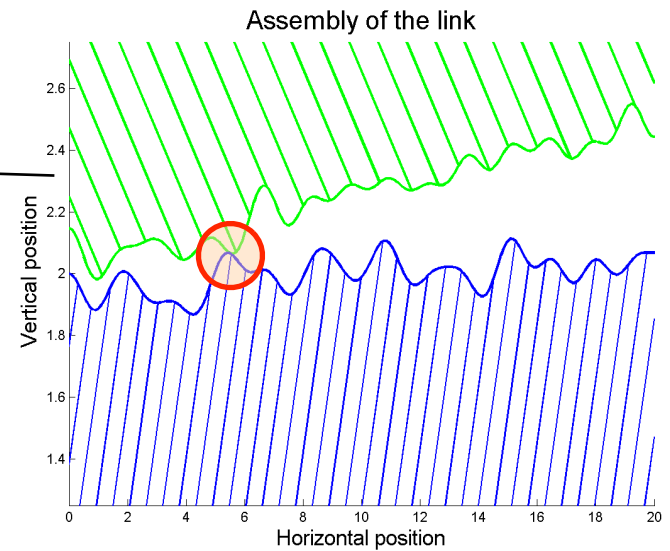
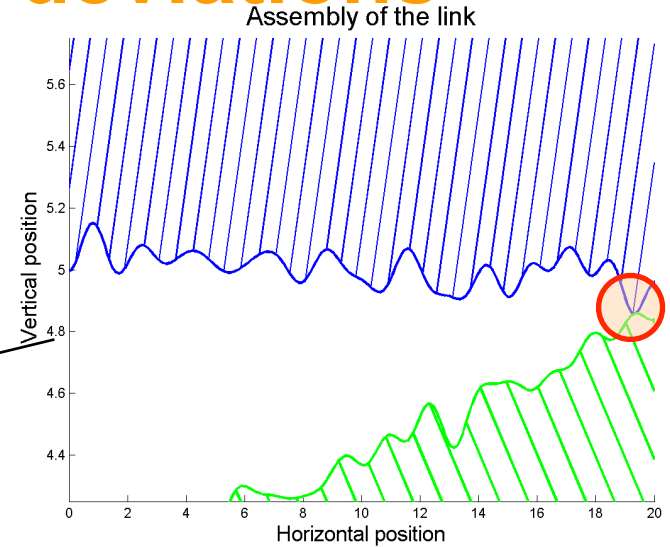
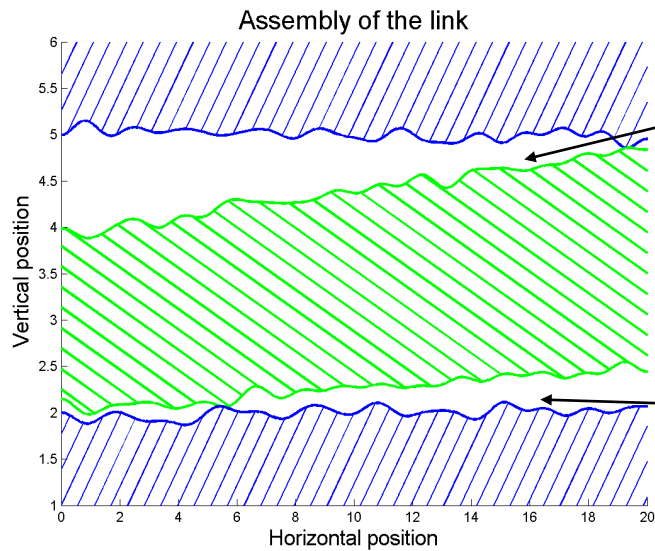
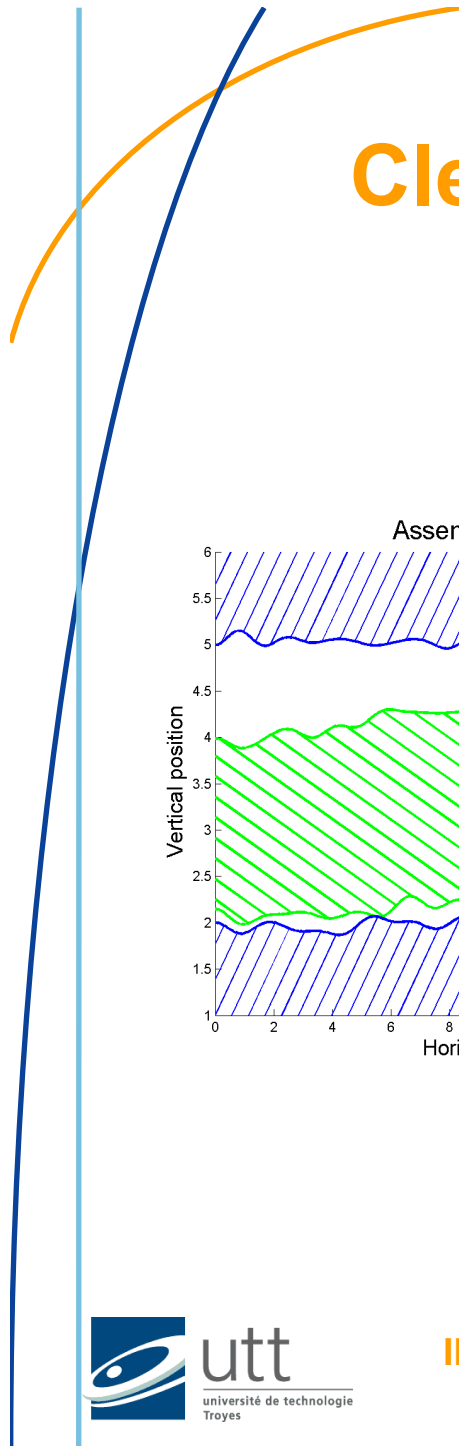

Clearance and form deviations

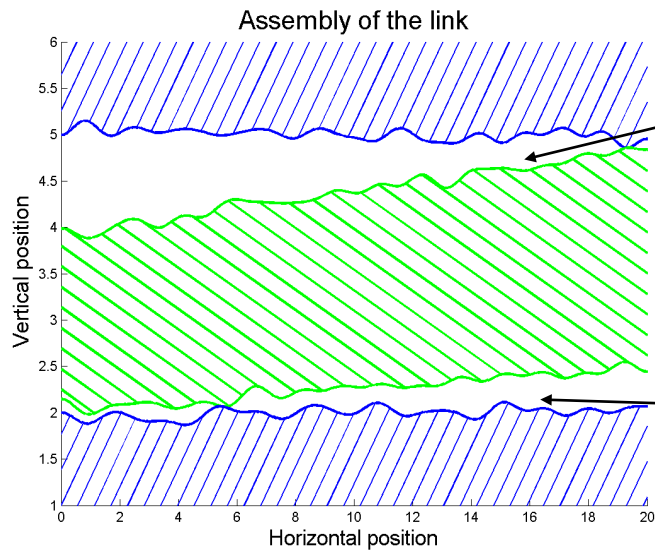

2 MIP

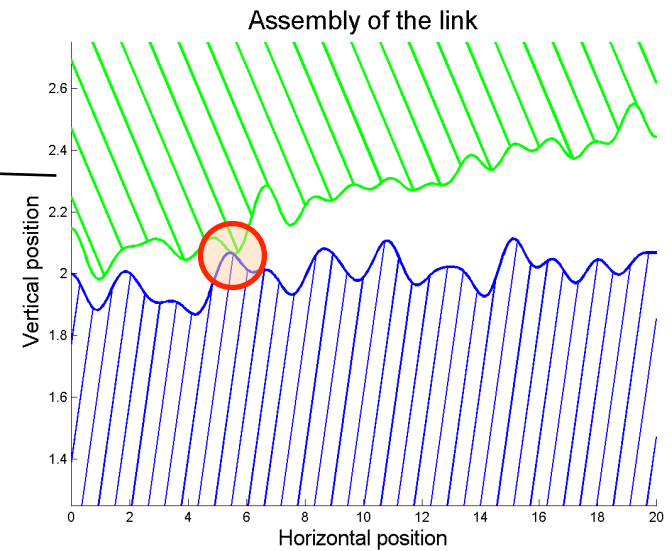
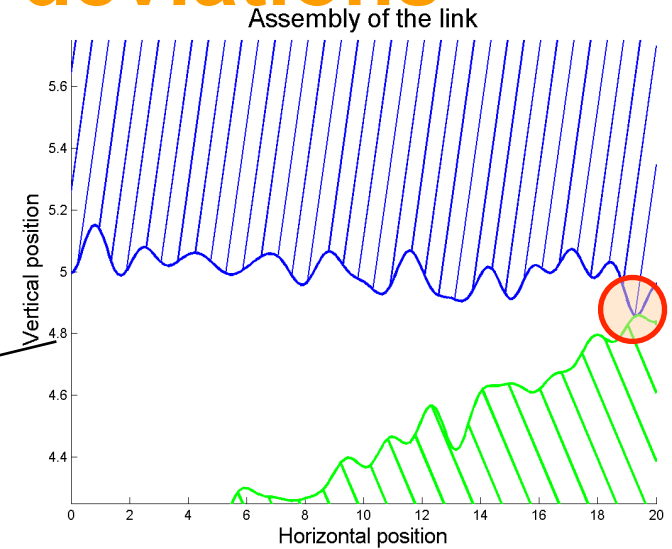



Clearance and form deviations

Clearance and form deviations

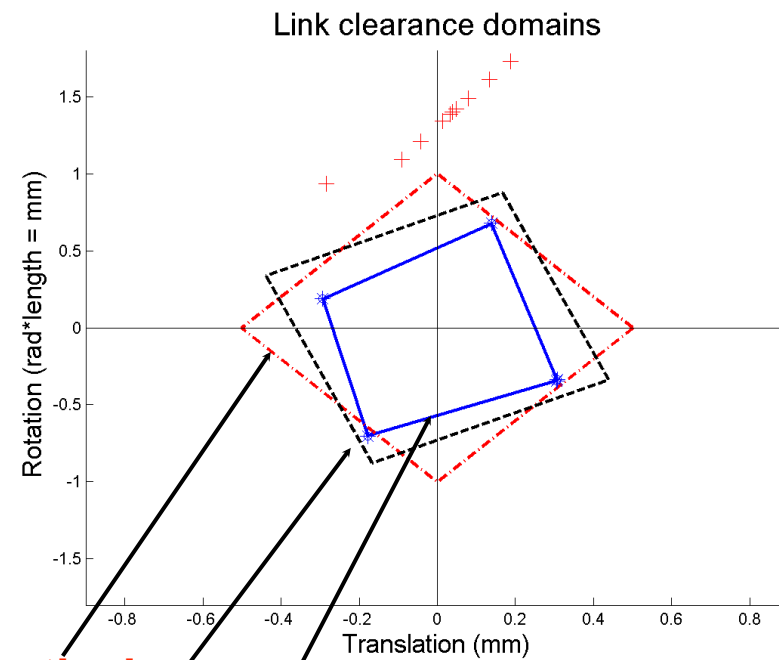
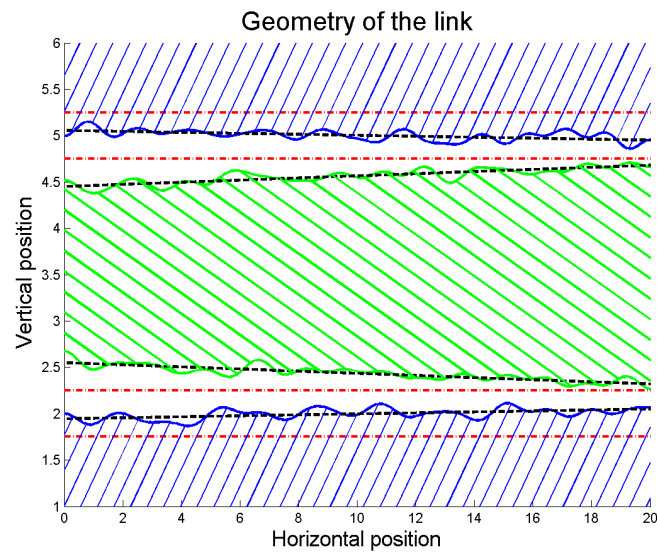

Theoretical
Rigid
Rigid + Form

Clearance and form deviations

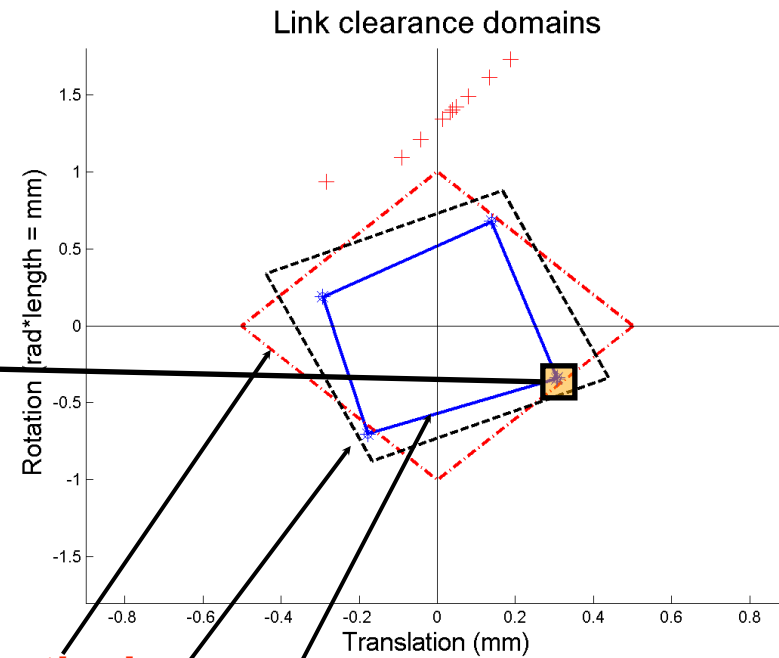
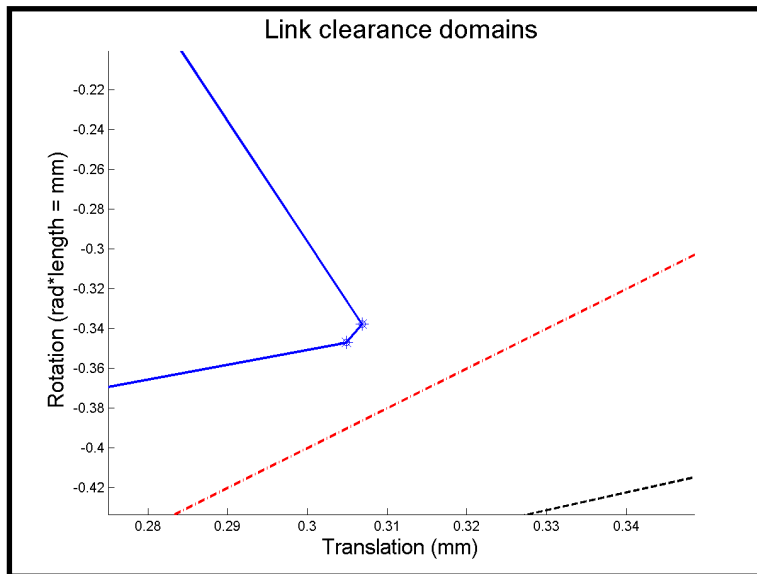

Theoretical

Rigid

Rigid + Form

Clearance and form deviations

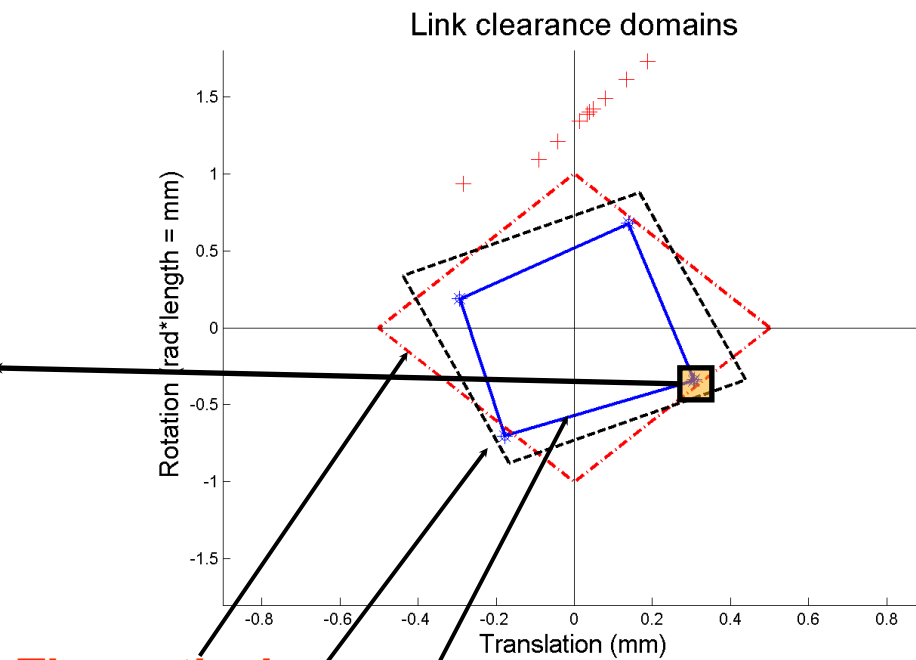
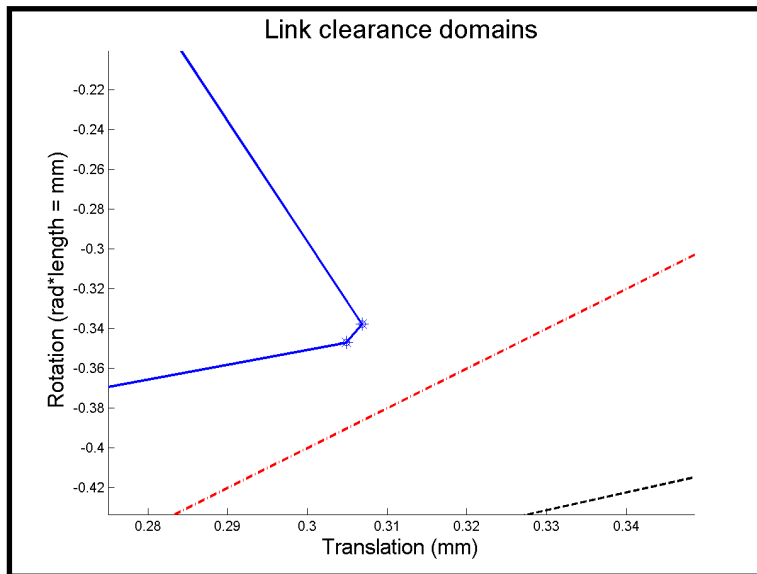

Total : 5 contact configurations

Theoretical

Rigid

Rigid + Form

Clearance and form deviations

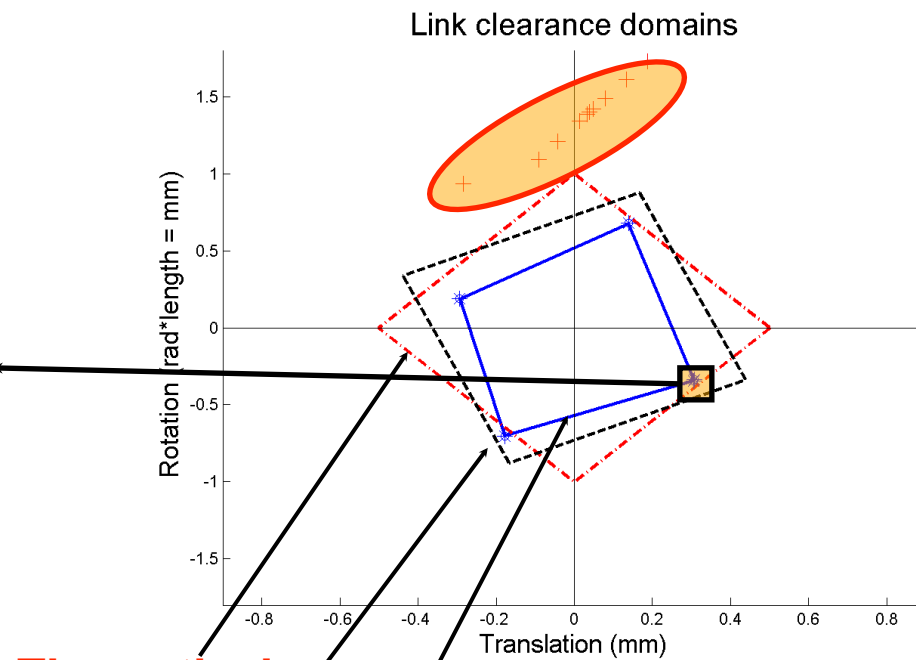
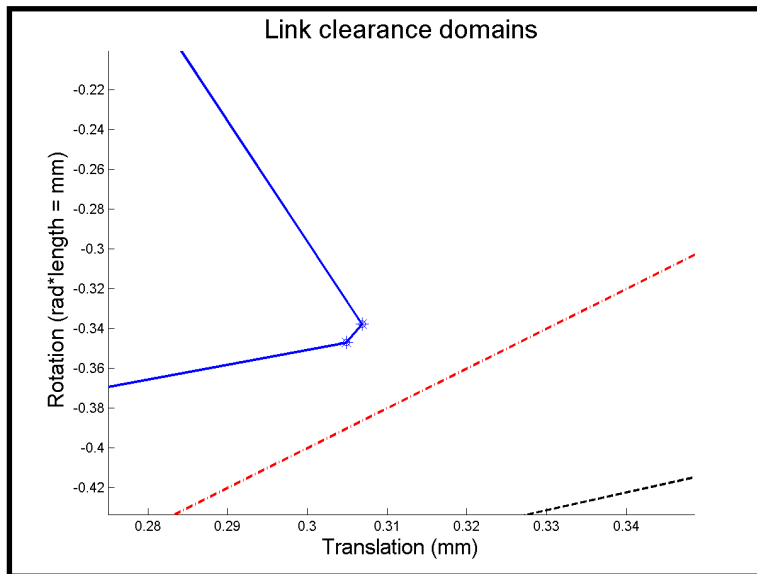

Total : 5 contact configurations

Theoretical

Rigid

Rigid + Form

Clearance and form deviations

- Same form deviation with larger clearance

Clearance and form deviations

- Same form deviation with larger clearance

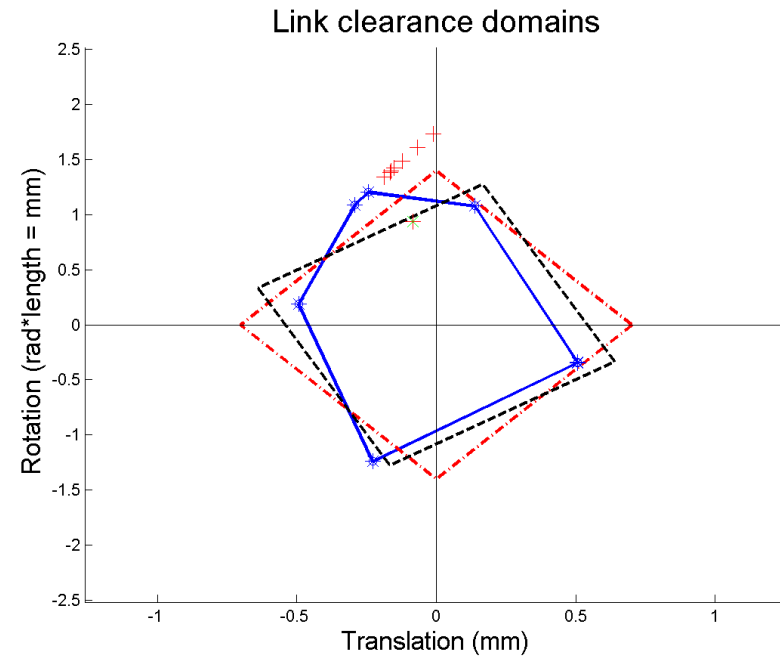
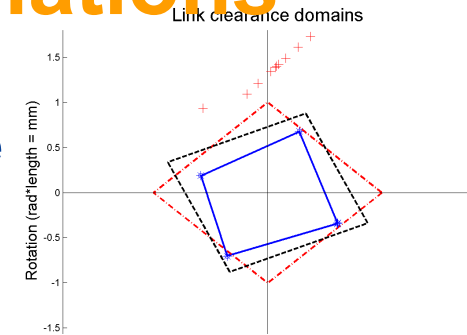

Clearance and form deviations

- Same form deviation with larger clearance

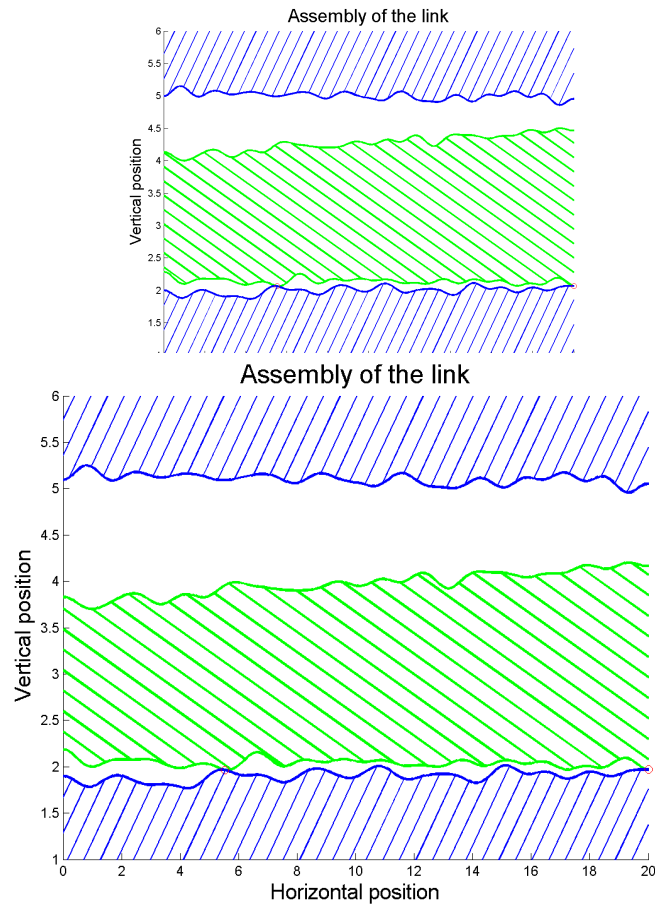

Link clearance domains

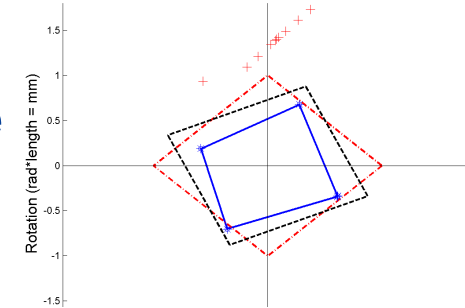

Link clearance domains

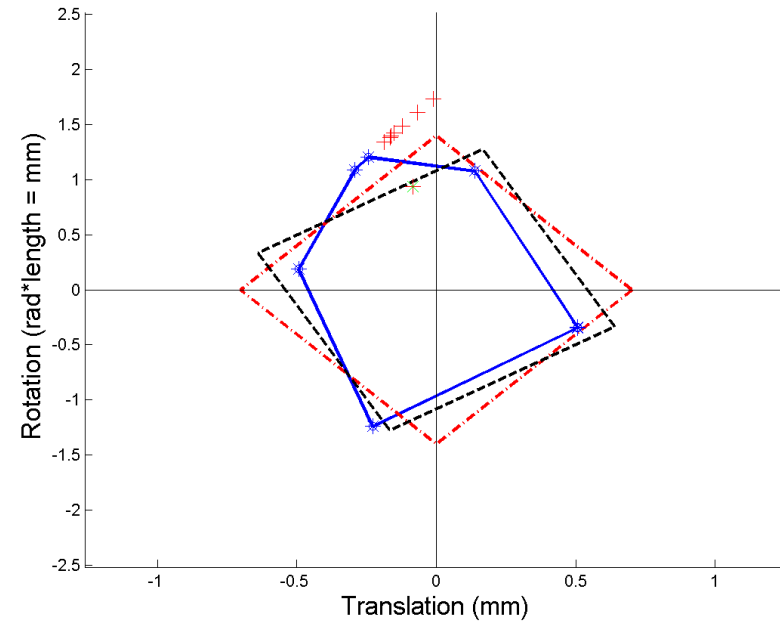

Clearance and form deviations

- Same form deviation with larger clearance

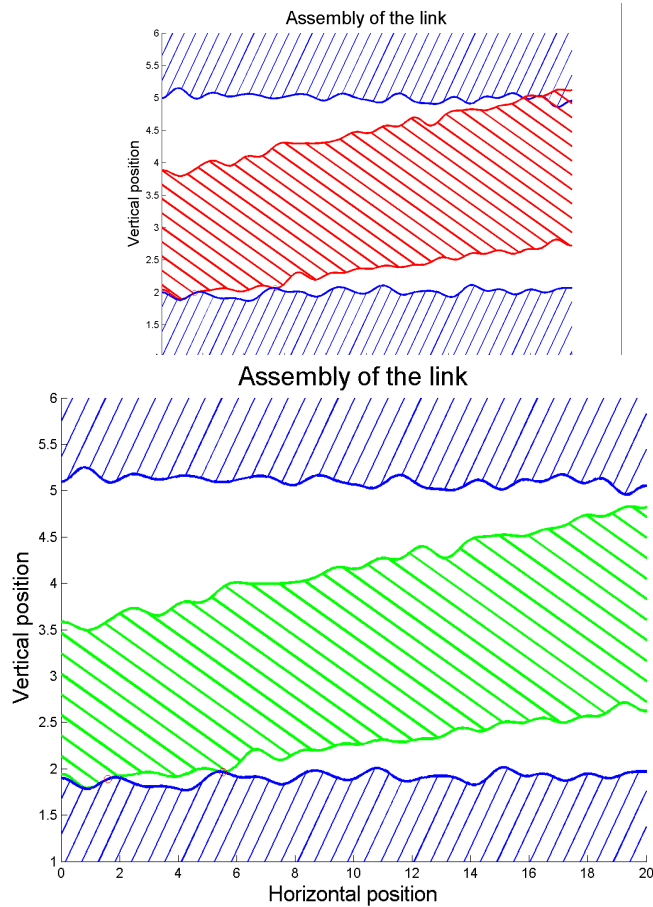

Link clearance domains

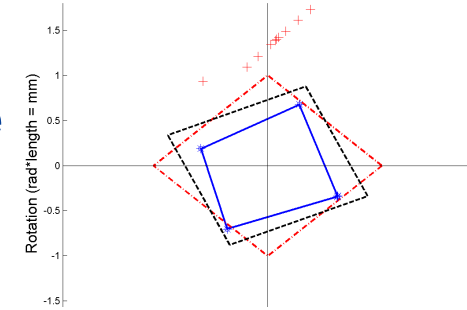

Link clearance domains

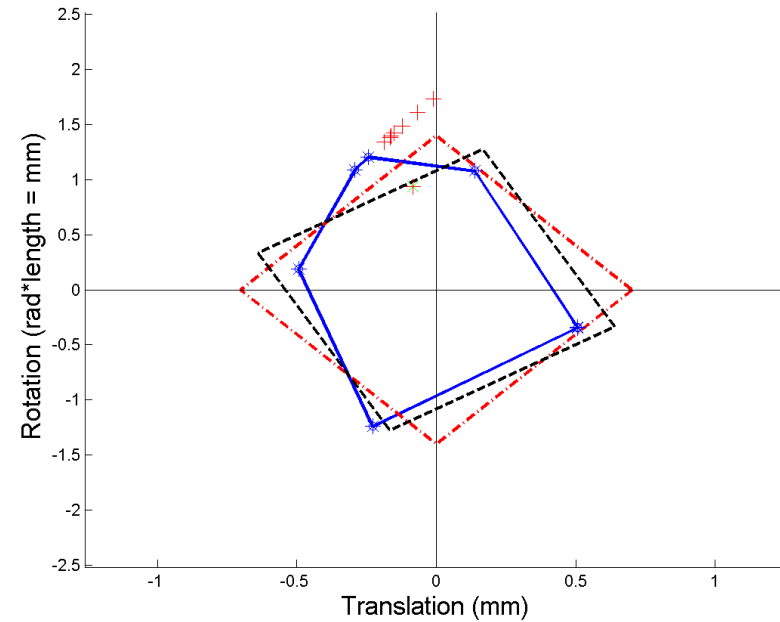

Clearance and form deviations

- Same form deviation with larger clearance

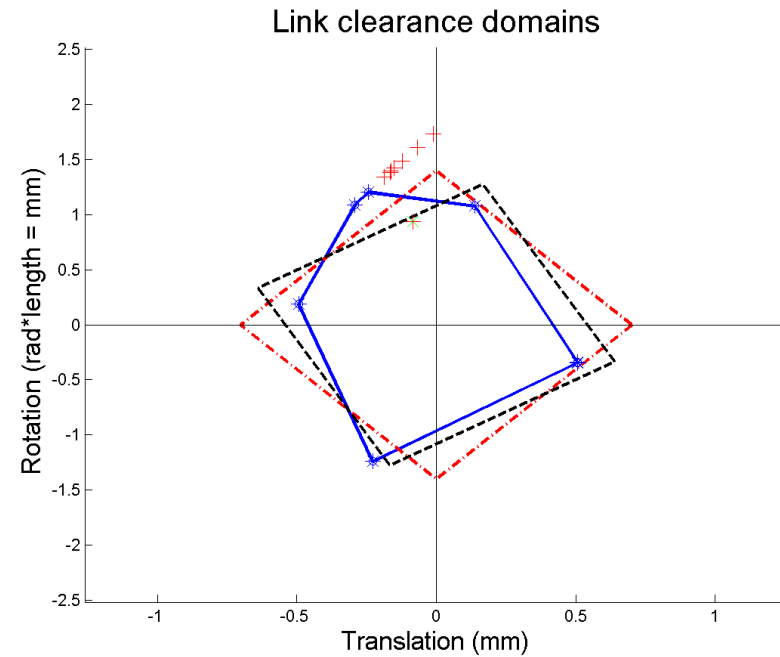
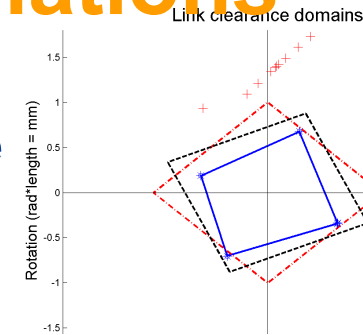
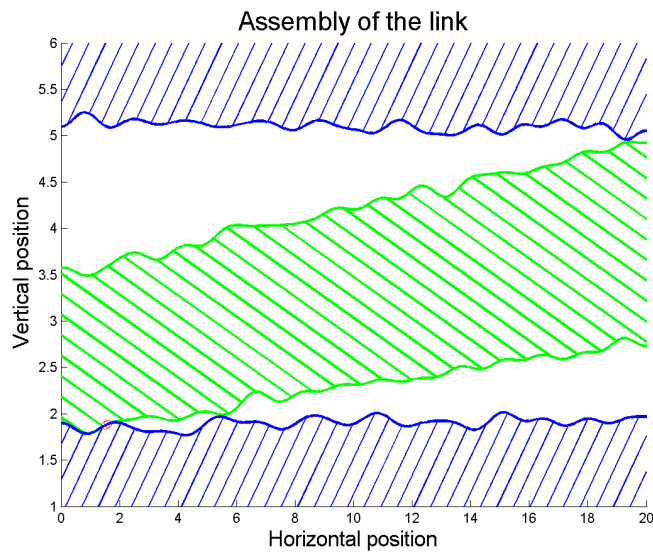

Clearance and form deviations

- Same form deviation with larger clearance

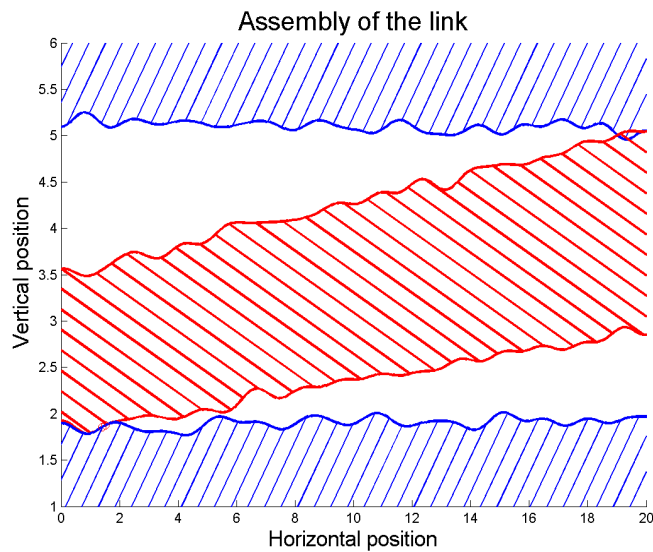

Link clearance domains

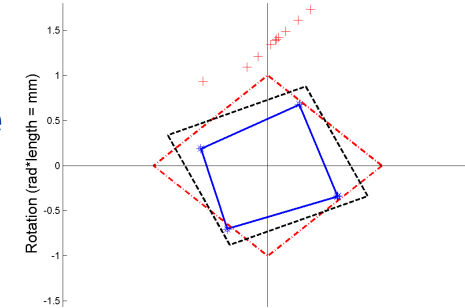

Link clearance domains

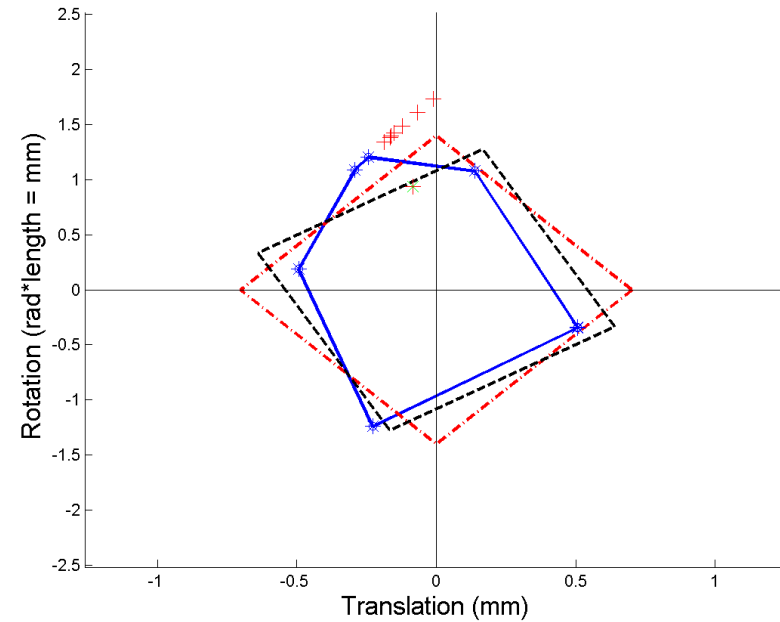

Assembly rates and GPS criterion

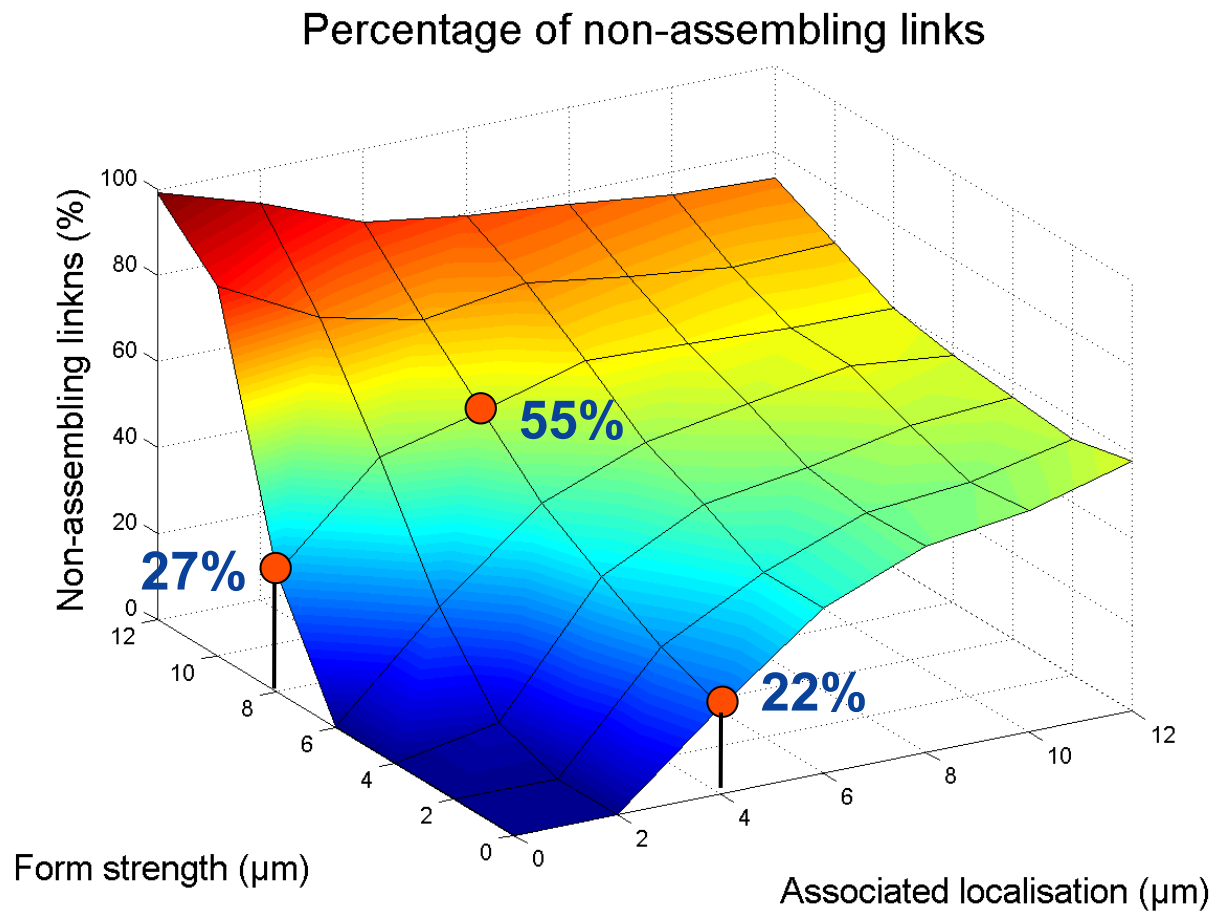

Conclusion

- **The modal parameterization :**
 - describes the shape deviations,
 - filters roughness,
- **The assembling approach:**
 - no undetermined position,
 - no optimization approach,

Prospects

- **To extend on 3D cases with clearance,**
- **Apply to other type of geometry,**
- **Has to be compared to experiments,**

How form errors impact on 2D precision assembly?



Pierre Antoine ADRAGNA pierre_antoine.adragna@utt.fr
Lab [LASMIS](#)

Université de Technologie de Troyes



Serge SAMPER , serge.samper@univ-savoie.fr
lab. [SYMME](#), Université de Savoie ANNECY, FRANCE



Hugues FAVRELIERE, hugues.favreliere@univ-savoie.fr
lab. [SYMME](#), Université de Savoie ANNECY, FRANCE

IPAS 2010 – February 2010 Chamonix-France