



HAL
open science

Pesticide Atomization Modelling for Hollow Cone Nozzle

Magali Simone Marie de Luca, Ariane Vallet

► **To cite this version:**

Magali Simone Marie de Luca, Ariane Vallet. Pesticide Atomization Modelling for Hollow Cone Nozzle. CIGR Ejournal, 2008, X (may), 9 p. hal-00453896

HAL Id: hal-00453896

<https://hal.science/hal-00453896>

Submitted on 5 Feb 2010

HAL is a multi-disciplinary open access archive for the deposit and dissemination of scientific research documents, whether they are published or not. The documents may come from teaching and research institutions in France or abroad, or from public or private research centers.

L'archive ouverte pluridisciplinaire **HAL**, est destinée au dépôt et à la diffusion de documents scientifiques de niveau recherche, publiés ou non, émanant des établissements d'enseignement et de recherche français ou étrangers, des laboratoires publics ou privés.

Pesticide Atomization Modelling for Hollow Cone Nozzle

M. De Luca and A. Vallet
Cemagref, 361 rue JF Breton - 34 196 Montpellier Cedex 5, France.
ariane.vallet@cemagref.fr

ABSTRACT

This paper presents a new approach to model the pesticide atomization in order to get the droplet size and velocity very close to the nozzle exit. The two-phase flow was calculated inside and outside the nozzle. The model was based on classical fluid mechanics transport equations for the liquid dispersion, velocity and turbulence. Moreover, a novel transport equation was developed for the mean liquid/gas surface area, coming from studies in automotive and aeronautics fields. Coupling the transport equations for the liquid mass fraction and the surface area led to an estimation of a Sauter Mean Diameter. These equations have been implemented in the commercial CFD code Fluent.

A swirling flow was found inside the nozzle. Moreover, a hollow cone liquid sheet expanded outside the nozzle. Calculations have been conducted with various injection pressure values, leading to a mass flow rate in good accordance with manufacturer data. Surfactant influence has been studied by varying the surface tension coefficient in the surface area transport equation: as expected, droplets obtained are smaller than when water is considered.

Keywords: Atomization, hollow cone nozzle, CFD, modelling, France

1. INTRODUCTION

Agricultural pesticide spraying commonly involves ejecting a water mixture made up of active molecules and adjuvants. During this process, some of the smallest droplets do not reach the plant and can contribute to the spray drift, contaminating air, water and soils. On the other hand, large or fast droplets can rebound from the leaves and may decrease the treatment efficiency.

Experimental field studies are not only complex and expensive to conduct but also depend on variable external conditions (temperature, humidity, wind velocity and direction) whereas the modelling approach can use invariable conditions.

For 30 years, the United States Department of Agriculture (USDA) Forest Service has developed models to calculate the pesticide dispersion applied by aerial application above forests. In the 1990's the north American consortium of chemical registrants called Spray Drift Task Force developed with USDA Forest Service and USDA Agricultural Research Service a Lagrangian model, AgDRIFT, to calculate the pesticide drift at time of application (Hewitt, 2000). This model has been criticized by Stoughton et al. (Stoughton et al., 1997). The authors carried out measurements in field of drift by LIDAR and compared their results with those of the AgDRIFT model. Whereas the model predicted that the majority of the product was deposited within a distance of 400 m of the emission source, the experiments showed that drops could be found beyond 2 km of the source. Other studies on pesticide drift have been developed. Miller and Hadfield proposed a 2D model to describe the drift of spray resulting from flat fan nozzle (Miller and Hadfield, 1989). Droplets are assumed to form at a

distance equal to the sheet coherent length and have the same velocity as the liquid sheet. Data for those two variables come from measurements using high-speed photography. The model results have been compared to experimental ones. The conclusion of the study emphasizes in particular the importance of the correct definition of sheet velocity. Moreover, hypothesis of spherical droplet may be not valid for large droplets.

Ultimately, studies have been conducted using CFD codes with an Eulerian/Lagrangian approach, considering isolated drops (Brown and Sidahmed, 2001), (Tsay et al., 2002). Near the nozzle exit, this hypothesis is probably wrong.

The objective of this work was to develop an Eulerian model in order to describe how the sprayed liquid is atomized into droplets in terms of velocity and diameter. The model was based on studies in automotive and aeronautics fields (Vallet et al., 2001), (Blokkeel et al., 2002). One of the model advantages is to consider liquid fragments that are neither necessarily spherical nor isolated. Moreover, the initial conditions (velocity, diameter) of the drops are calculated by the model and not prescribed as in the Lagrangian models.

2. MATERIALS AND METHODS

The computations were performed using the CFD code Fluent version 6.2.16 (Fluent, 2005). It uses a finite-volume numerical procedure to solve the Navier-Stokes equations governing a fluid flow. In the turbulent flows additional equations are solved for the conservation of parameters of the turbulence model. The Reynolds Stress Model has been chosen in our study. This model was actually more suitable than the classical k- ϵ model, as the flow considered was highly non isotropic.

In order to model the typical length scale of the liquid fragments, a new transport equation has been implemented in Fluent using User Defined Functions. The functions were coded in C language and the equations have been explained in detail by De Luca et al. (De Luca et al., 2007). The numerical technique involved subdividing the domain of interest into a finite number of control volumes or cells. The partial difference equations were transformed into their discrete form over these cells. Because of the non linearity and interdependence of the differential equations, an iterative solution was adopted. A steady approach has been considered, so the local time derivative terms of the set of equations were neglected.

The model was applied to a hollow cone nozzle particularly used for fungicide and insecticide treatments in orchards and vineyards. The calculation domain, shown in Figure 1, was composed of two parts: the nozzle itself (top of the figure) bordered by the nozzle walls and the outlet domain (half of the cylinder with a 7.2 mm radius and 5.5 mm in height). A tangential canal leads the liquid into the conical swirl chamber. The liquid exits through a hole diameter $D_c=0.92$ mm. Due to the vortex the spray comes out in a cone shape. The domain is rotationally periodic. The injection pressure is fixed at 5 bar. A constant value of the pressure equals to the atmospheric pressure was imposed on the boundaries of the cylinder. The geometry was generated with the Gambit 2.2 software package. The constructed numerical grid consisted of 430, 000 tetrahedral cells. The narrower diameter of the nozzle D_c was composed of 20 cells. The total computational time was of the order of 12 hours on a Pentium 4 running with a 3.2 GHz processor.

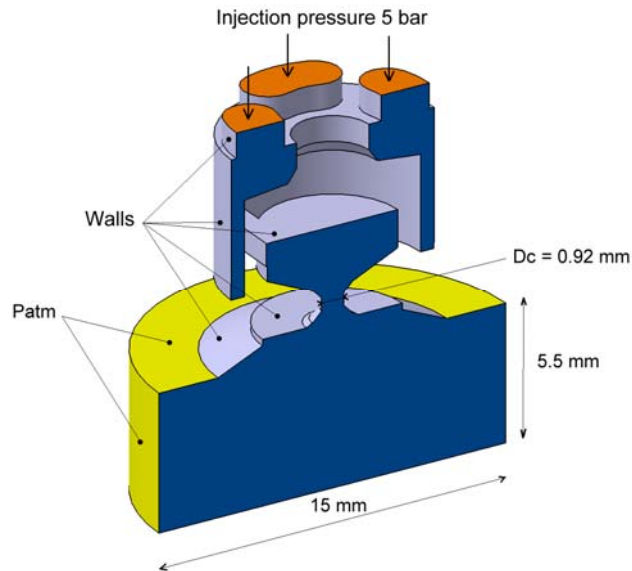

Figure 1. The calculation domain composed of two parts: the nozzle itself bounded by walls (top of the figure) and the outlet domain bounded by an atmospheric pressure condition (bottom of the figure)

Inlet boundary conditions:

Injection pressure: 5 bar

Liquid mass fraction for water=1.

Air mass fraction = 0

Walls:

No slip condition, zero diffusive flux for the mass fraction and the mean surface area.

Outlet boundary conditions:

Atmospheric pressure $P = P_{\text{atm}}$.

3. RESULTS AND DISCUSSION

3.1 Liquid Mass Fraction Field

Figure 2 shows the liquid mass fraction field in the periodic faces. The mass fraction is bounded by 0 (in the air phase) and 1 (in the pure liquid phase). The nozzle itself is filled with liquid only. Outside the nozzle, the hollow cone liquid shaped sheet is clearly visible where the mean liquid mass fraction value varies from 0 to 1. In the spray centre, the liquid mass fraction tends to 0 confirming an air core presence. The air core has an upward movement, as seen in the Figure 3 (i.e. negative velocity component in the spray centre).

As expected the flow is essentially tangential inside the swirl chamber (see Figure 4), whereas the sheet is highly radial outside the nozzle (see Figure 5). It can be seen that the flow is not really well calculated near the point between the divergent edge (wall) and the horizontal edge of the outlet domain (pressure outlet): the domain should be actually modified in order to avoid this kind of numerical problem.

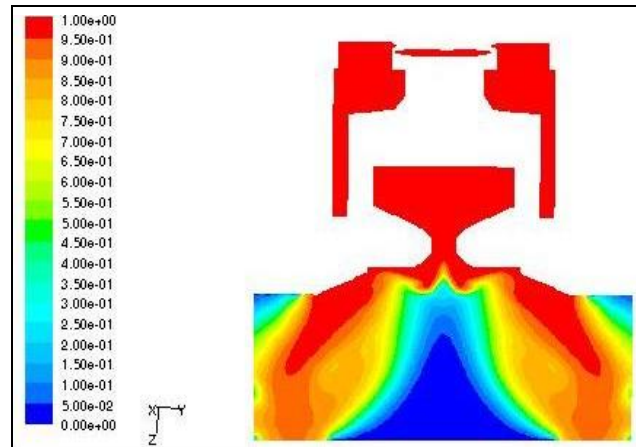

Figure 2. Field of the mean liquid mass fraction in the periodic faces. The nozzle itself is filled with liquid only. Outside the nozzle, the hollow cone liquid shape is visible.

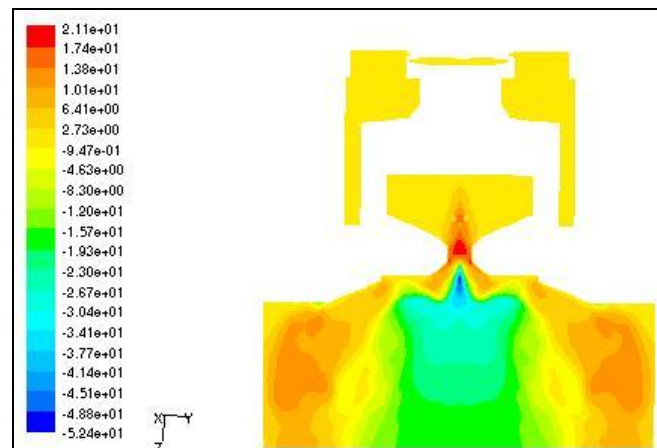

Figure 3. Field of the axial velocity component (m/s).
The air core has an upward movement

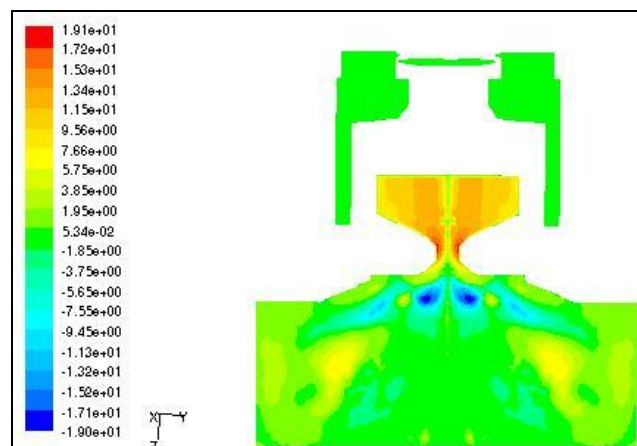

Figure 4. Field of the tangential velocity component (m/s).
The flow is essentially tangential inside the swirl chamber

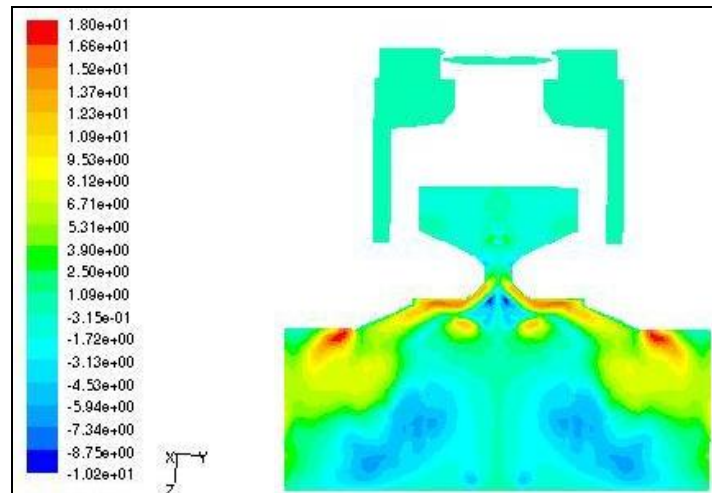

Figure 5. Field of the radial velocity component (m/s).
The flow is highly radial outside the nozzle

The size distribution in the exit face (i.e. bottom of the calculation domain, as a half of a disc of radius 7.5 mm) versus diameter class is presented on Figure 6, whereas Figure 7 shows the flux distribution versus diameter class. Even if less than 10% of the total droplet number have a diameter larger than 160 μm , the flux of these large droplets represent more than 25% of the total flux.

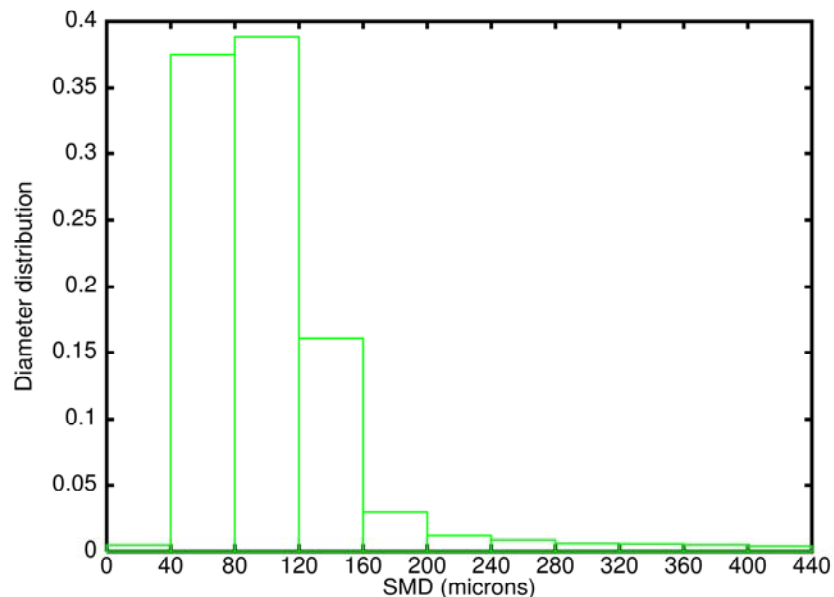

Figure 6. Diameter distribution in the domain exit. Less than 10 % of the total droplet number have a diameter larger than 160 μm

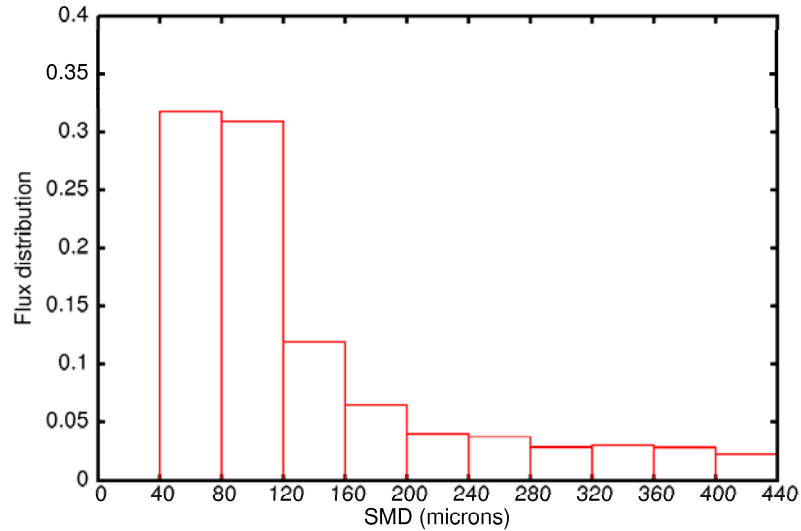

Figure 7. Flux Distribution in the domain exit face versus diameter class. The flux of the droplets with a diameter less than 160 μm represents more than 25 % of the total flux

3.2 Injection Pressure Influence

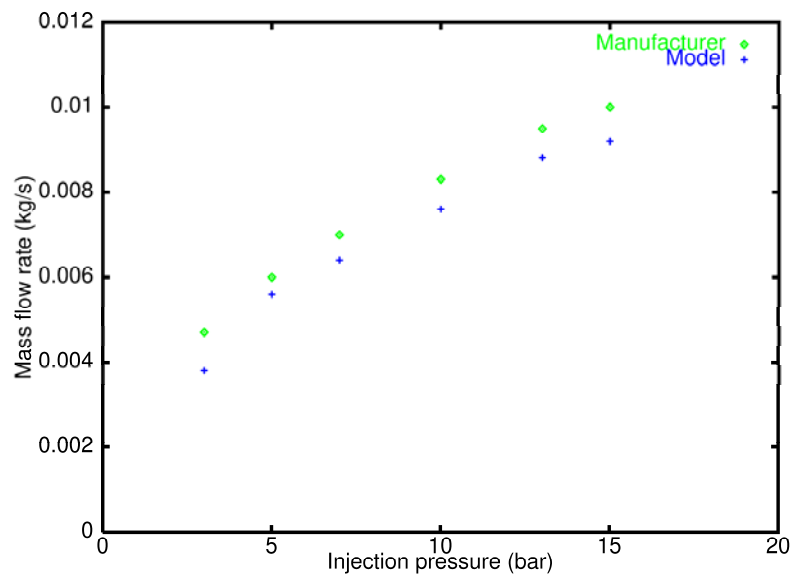

Figure 8. Comparison between the mass flow rate calculated by the model and the mass flow rate given by the manufacturer for various injection pressure values

The model has been applied using various injection pressure values, from 3 to 15 bar, following the manufacturer recommendation. The calculated liquid mass flow rate is in good accordance with the flow rate estimated by the nozzle manufacturer, as show in Figure 8.

Figure 9 gives radial profiles of the mean radius at an axial distance of $z=2D_c$ for two injection pressure values. The spray axis corresponds to a 0 radial distance. It can be seen that, as expected, the mean radius decreases as the pressure increases in the highly liquid regions.

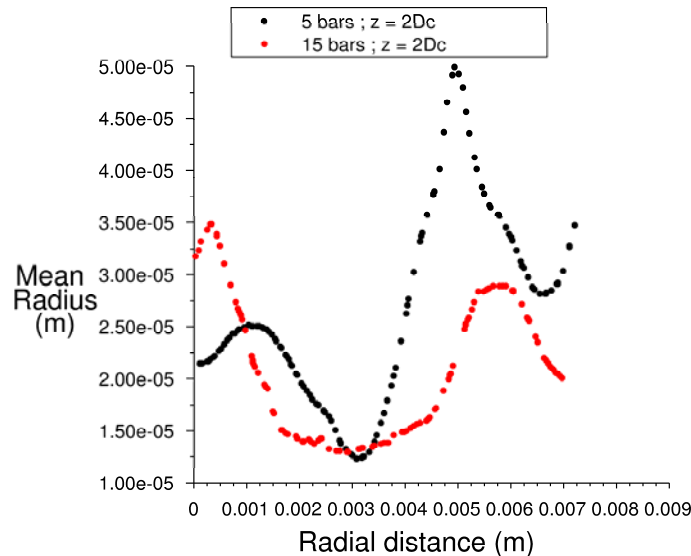

Figure 9. Injection pressure influence.

The droplet mean radius decreases as the liquid injection pressure increases

3.3 Surfactant Influence

The liquid solution used consists of a mixture of water, active ingredients and surfactants. Some of the surfactants are used to increase the spreading of the liquid on the plants and decrease the rebound by reducing the surface tension. In the numerical study, the surface tension coefficient has been changed from the initial value 72 mN/m (water solution) to a new one equal to 24 mN/m (surfactant solution). Note that this quantity is involved in the calculations of the mean diameter, but is not taken into account to calculate the liquid dispersion, as it is supposed that the surface tension plays a role only at small scales, by analogy with the viscosity in turbulent flows.

Figure 10 shows the radial profiles of the Sauter Mean Diameter versus the radial distance for the axial distance $z=2D_c$ for two surface tension coefficient values. Decreasing the surface tension coefficient leads to smaller droplets in the spray centre and in sheet region.

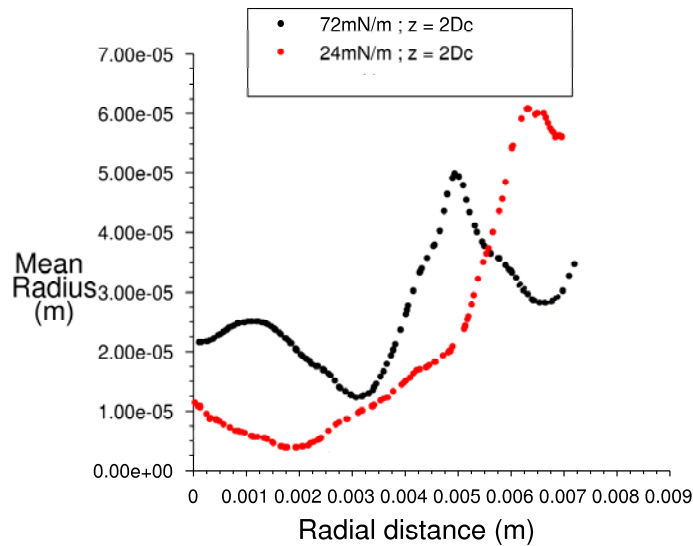

Figure 10 Influence of the surface tension coefficient. Decreasing the surface tension coefficient leads to smaller droplets

4. CONCLUSIONS

A model of atomization applied in the motor engine field has been adapted to the modelling of pesticide atomization. The flow inside and outside a swirl nozzle has been calculated. Inside the nozzle, a swirly flow has been observed. Outside the nozzle, the flow was mainly radial. The liquid dispersion outside the nozzle was calculated and a hollow cone shaped sheet was predicted. Moreover, the model gave an insight into the Sauter Mean Diameter of the droplets outside the nozzle. Inside the spray core, small droplets were found. At the spray edges, the presence of larger droplets was predicted. Various injection pressure values have been used. The higher the injection pressure is, the smaller the droplets are, confirming previous studies on sprays. Moreover, the influence of the surface tension coefficient has been studied, showing that surfactants can lead to smaller droplets.

Results presented here show that this new approach can be useful to model the atomization region, and give insight on velocity and radius of droplets in regions that are not reachable experimentally. Anyway, it is only the beginning of this new approach, and it will be necessary to continue in order to validate it on other geometries. It will be interesting to couple this approach with a Lagrangian calculation downstream, in order to follow the liquid dispersion from the nozzle to the target.

5. ACKNOWLEDGEMENTS

Financial support from the French Environment and Energy Management Agency (ADEME) is gratefully acknowledged.

6. REFERENCES

- Blokkeel, G., X. Silvani, and F.X. Demoulin. 2002. *18th Annual Conference on Liquid Atomization and Spray Systems*, Zaragoza, Spain.
- Brown, R., and M.M. Sidahmed. 2001. Simulation of spray dispersal and deposition from a forestry airblast sprayer - Part II: Droplet trajectory model. *Transactions of the ASAE*, Vol. 44(1): 11-17.
- De Luca, M., A. Vallet, and R. Borghi. 2007. *21st Annual Conference on Liquid Atomization and Spray Systems*, Mugla, Turkey.
- Fluent. 2005. *Fluent 6-2 User's Guide*.
- Hewitt, A.J. 2000. Spray drift: impact of requirements to protect the environment. *Crop Protection*, Vol. 19: 623-627.
- Miller, P.C.H., and D.J. Hadfield. 1989. A simulation model of the spray drift from hydraulic nozzles. *J. agric. Engng Res.*, Vol. 42: 135-147.
- Stoughton, T.E., D.R. Miller, X. Yang, and K.M. Ducharme. 1997. A comparison of spray drift predictions to lidar data. *Agricultural and Forest Meteorology*, Vol. 88: 15-26.
- Tsay, J., R.D. Fox, H.E. Ozkan, R.D. Brazee, and R.C. Derksen. 2002. Evaluation of a pneumatic-shielded spraying system by CFD simulation. *Transactions of ASAE*, Vol. 45(1): 47-54.
- Vallet, A., A.A. Burluka, and R. Borghi. 2001. Development of an Eulerian model for the atomisation of a liquid jet. *Atomization and Sprays*, Vol. 11(6): 619-642.