



HAL
open science

Sizing safety vents for non-tempered systems (organic peroxides): a new tool at lab scale

Luc Véchet, Jean-Pierre Bigot, Marc Kazmierczak, Patricia Vicot

► **To cite this version:**

Luc Véchet, Jean-Pierre Bigot, Marc Kazmierczak, Patricia Vicot. Sizing safety vents for non-tempered systems (organic peroxides): a new tool at lab scale. XI^e Congrès de la Société Française de Génie des Procédés. Des réponses industrielles pour une société en mutation., Oct 2007, Saint Etienne, France. pp.ISBN=2-910239-70-5. <hal-00451759>

HAL Id: hal-00451759

<https://hal.science/hal-00451759v1>

Submitted on 30 Jan 2010

HAL is a multi-disciplinary open access archive for the deposit and dissemination of scientific research documents, whether they are published or not. The documents may come from teaching and research institutions in France or abroad, or from public or private research centers.

L'archive ouverte pluridisciplinaire **HAL**, est destinée au dépôt et à la diffusion de documents scientifiques de niveau recherche, publiés ou non, émanant des établissements d'enseignement et de recherche français ou étrangers, des laboratoires publics ou privés.



HAL Authorization

Sizing safety vents for non-tempered systems (organic peroxides): a new tool at lab scale

VECHOT Luc^a, BIGOT Jean-Pierre^{a*}, KAZMIERCZAK Marc^b, VICOT Patricia^b

^a *ENSM-SE, Centre SPIN, Département GENERIC, 158, Cours Fauriel 42023 Saint-Etienne Cedex 2*

^b *Direction Certification, INERIS BP2, 60550 Verneuil en Halatte*

Abstract

This paper deals with the development of a new experimental “similarity” vent sizing tool for non tempered chemical system combining the advantages of both DIERS method (laboratory scale) and UN similarity method (less overconservative). This tool is an extension of the VSP2 (Vent Sizing Package II) adiabatic calorimeter.

The objective of this new vent sizing tool is twofold. The first is to provide the required A/V ratio necessary to assure a safe relief. The second is to provide measurement of mass vented during blow-down. This paper gives a description of this tool and exposes the first promising results obtained. Its main limits are also given.

Keywords:

non tempered reaction ; runaway reaction ; similarity ; cumene hydroperoxide (CHP) ; adiabatic calorimeter

1. Introduction

In order to protect chemical reactors from runaway reactions, vent sizing methods, based on data obtained from adiabatic calorimetry and two-phase flow models, were designed by the DIERS (Design Institute for Emergency Relief System). Nevertheless, these methods can lead to unrealistically large vent areas, specially for untempered systems (gas-generating and hybrid systems, peroxide decomposition for example). In the case of peroxide decomposition runaway reaction, DIERS vent area can be overestimated by one order of magnitude (Fauske, 2000).

More realistic vent areas are obtained with “similarity methods” such as the one proposed by the United Nation Manual of Tests and Criteria (UN) for the transportation of peroxide. This latter method has the disadvantage of being time consuming, laborious and requires heavy safety precautions.

This paper proposes a new similarity vent sizing tool combining the advantages of both DIERS method (laboratory scale) and UN method (less overconservative). This tool allows blowdown experiments to be carried out at laboratory scale. The objectives are both direct determination of the required vent area and measurement of the mass vented during blow-down.

First of all, a diagnostic of vent sizing methods for gassy system is done. Reasons which led us to build this new tool are underlined. A description of the new tool is then given. Finally validation tests and limits of the new tool are presented.

2. Context of this work

Our initial objective was to understand the reason why DIERS vent sizing method for untempered system was often overconservative.

2.1 DIERS classical method for gassy systems

DIERS classical vent sizing method for pure gassy systems (Le).

* Corresponding author: bigot@emse.fr

$$\frac{dm}{dt} = -W = -GA \quad (1)$$

$$\frac{dm_g}{dt} = m \dot{m}_g - W x_i \quad (2)$$

Safe vent size is obtained if the pressure rise can be stopped when gas generation rate is maximum. This leads to consider a pressure rise rate equal to zero at turn-around:

$$\frac{dP}{dt} = 0 \quad (3)$$

By assuming ideal gas and constant liquid specific volume, recombining Equations 1 to 3 leads to the following expression for the vent area, A:

$$G_c A v_i = v_g m \dot{m}_g + \frac{V_g}{T} \left(\frac{dT}{dt} \right) \quad (4)$$

Where $v_i = x_i v_g + (1 - x_i) v_l$ is the inlet specific volume.

This equation means that *at turn-around* the volumetric discharge rate is equal to the sum of:

- Volumetric gas generation rate by reaction
- Volumetric expansion rate due to thermal dilatation. We will neglect this term as is generally done.

All of the terms in Equation 4 (G_c , v_i , m and \dot{m}_g) have to be evaluated at turn-around in order to calculate the vent area. They are unfortunately not known. So, DIERS method makes the following safe assumptions at turn-around:

- all the initial mass is still present in the vessel: $m = m_0$ (Leung and Fauske, 1987)
- flow through the vent is homogeneous (Leung, 1995): $G_c = (G_c)_{HEM}$
- reactor contents are homogeneous (Leung, 1995): $\alpha = \alpha_{hom}$
- reaction rate is maximum: $\dot{m}_g = \dot{m}_{g_{max}}$; this latter is obtained from measurements in an adiabatic calorimeter.

DIERS vent sizing formula resulting from the above assumptions is then:

$$A = \frac{m_0^2 T_{max} V_2}{m_i T_{2max} V_R} \frac{1}{P_{max}} \left(\frac{dP_2}{dt} \right)_{max} \frac{1}{(G_c)_{HEM hom}} \quad (5)$$

2.2 Similarity method: UN 10 litre vessel test

The United Nation Manual of Test and Criteria (UN) proposes a similarity method using a 10 dm³ vessel test. The similarity method reproduces experimentally at small scale the phenomena which occurs at large scale during the runaway and the blow-down. The aim of this method is to obtain similarity concerning:

- runaway reaction kinetics (as DIERS method does)
- hydrodynamic behaviour: two phase vent flow and vessel hydrodynamics at small scale representative of the ones occurring at large scale.

If these two similarity conditions are obtained then vent area which provides safe protection of the small scale reactor is scaled up using: $A/V = \text{constant}$. Area to volume scale up is conservative in the case of non tempered systems because relative mass loss is larger at larger scale (Leung and Fauske, 1987).

The UN 10 litre vessel test leads to a more realistic vent area compared to DIERS method, because prior mass loss and two phase flow are experimentally taken into account.

2.3 A laboratory similarity vent sizing tool

DIERS vent sizing method has the advantage to be carried out at laboratory scale but it is often overconservative. Even if a more realistic vent size can be obtained with the UN 10 litre vessel test, this latter method has the disadvantage to be time consuming, laborious and requires heavy safety precautions due to the fact that the sample size is large.

Our objective is to design a similarity vent sizing tool at laboratory scale. This similarity laboratory tool has to simulate blowdown experiments by the mean of a relief system. We also decided to measure vented mass (Δm) during relief. This can give an estimate of the contribution of this factor in DIERS oversizing.

3. New “similarity vent sizing tool” features

This tool is an extension of the adiabatic calorimeter VSP2. The reactor in which chemical runaway reaction occurs is the “VSP2 blowdown test cell”. The extension of the VSP2 consists in:

- the addition of a relief system
- the addition of a vented mass measurement device
- the adaptation of VSP2 to blowdown experiments

3.1 Addition of relief system

Two venting systems generally exist on chemical reactors or storage vessels:

- a feed bleed system which is designed to avoid pressure changes when filling or emptying the capacity. This feed bleed system is supposed to vent only gas.
- a rupture disc (or a safety valve), which is designed to open when the pressure in the reactor reaches the vent set pressure (P_s)

Small extra gas quantities are vented via the feed-bleed system. This maintains the pressure in the reactor close to the atmospheric pressure. Gas flow rate is a function of feed bleed size. In case of runaway reaction, pressure in the reactor starts to increase when gas volumetric generation rate is greater than the volumetric discharge rate via the feed-bleed system. The rupture disc opens when pressure in the reactor reaches P_s .

In the new vent sizing tool, the rupture disc is simulated by a *relief vent line* and the feed bleed system by a *feed bleed line* (Figure 1).

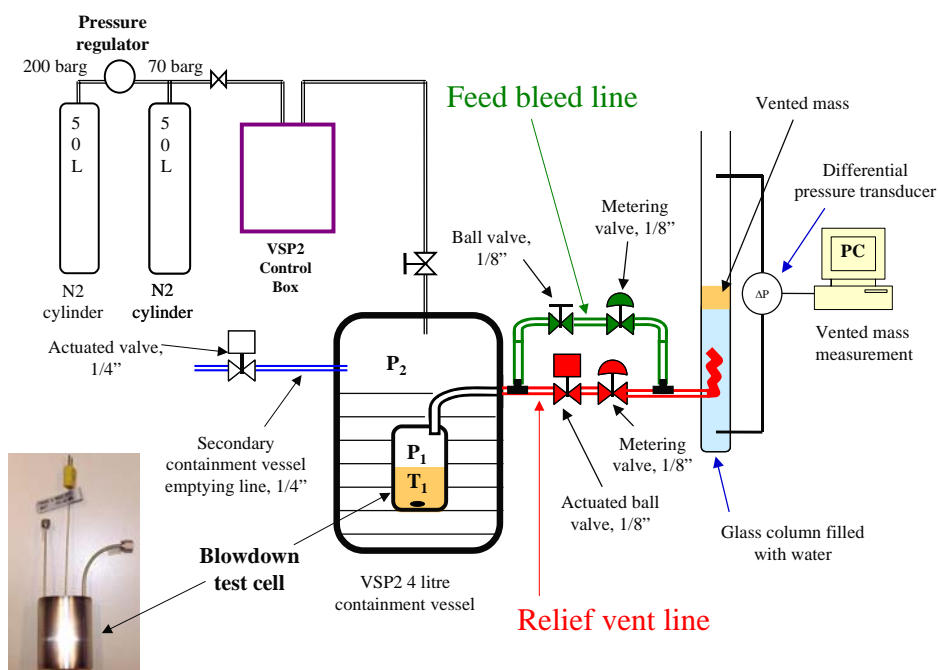

Figure 1. New similarity vent sizing tool

3.1.1 Relief vent line

The relief vent line is connected to the outlet of the blowdown test cell outside of the VSP2 containment vessel (Figure 2). This line is made of 1/8" stainless steel tube (inner diameter = 1.76 mm). The line includes an actuated 1/8" ball valve ($C_V = 0.2$) followed by a 1/8" metering valve (needle valve) ($C_V = 0-0.03$). When pressure in the test cell reaches set pressure, an opening signal is sent by the VSP2 software to the ball valve actuator. By this way, the test cell is opened to the atmosphere. Contents of the test cell are vented through the metering valve. Venting flow is a function of the metering valve opening.

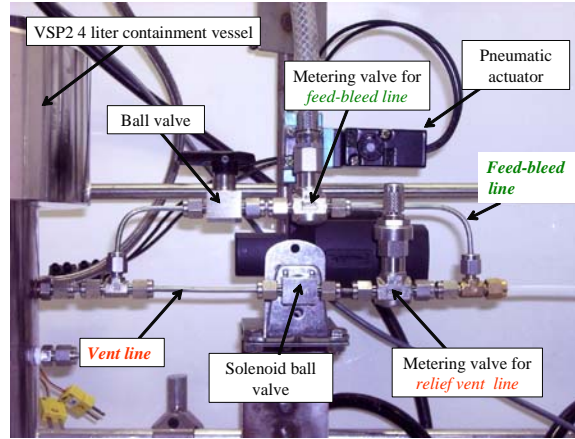

Figure 2. Picture of relief system

3.1.2 Relief vent line

The feed bleed line is installed in parallel to the relief vent line (Figure 2). It's also made of 1/8" stainless steel tube and includes a manual 1/8" ball valve followed by a 1/8" metering valve (needle valve).

During a runaway experiment, this line is always "open".

3.1.3 Determination of equivalent ideal nozzle diameter for the relief vent line

The objective of the new vent sizing tool is to obtain directly the required A/V ratio for a rupture disc. Our relief system is composed of several complex elements and cannot be considered as an ideal nozzle.

We determined an "equivalent ideal nozzle" area corresponding to the relief vent line.

For each setting of the metering valve, a depressurization test of the VSP2 containment vessel (using nitrogen) through the relief vent line provides a curve:

$$\dot{m}_{N_2} = \frac{V_2 M_{wg}}{RT} \left(\frac{dP_2}{dt} \right) = f(P_2) \quad (6)$$

The obtained curved has to be compared to a gas flow model for an ideal nozzle described with the following equations:

$$\dot{m}_{critical} = A \sqrt{\gamma \rho_2 P_2 \left(\frac{2}{\gamma+1} \right)^{\frac{\gamma+1}{\gamma-1}}} \quad (7)$$

$$\dot{m}_{subcritical} = A \sqrt{\frac{2\gamma}{\gamma-1} \rho_2 P_2 \left[\left(\frac{P_{atm}}{P_2} \right)^{2/\gamma} - \left(\frac{P_{atm}}{P_2} \right)^{(\gamma+1)/\gamma} \right]} \quad (8)$$

where : $\gamma = (C_p/C_v)_{N_2}$

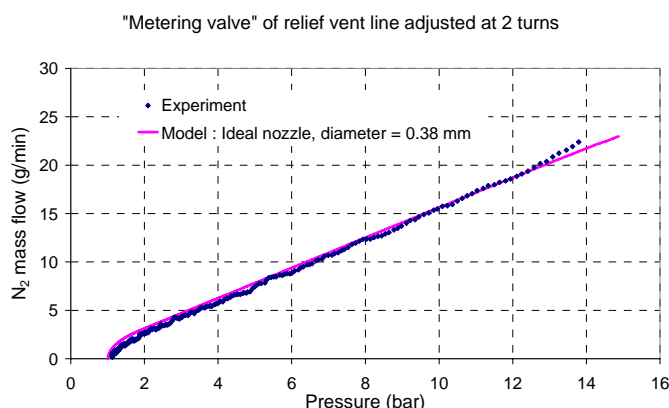

Figure 3. Characterization of relief vent line

Figure 3 presents data obtained for the depressurisation of the containment vessel with the metering valve of relief vent line adjusted to 5 turns open. The experimental data are fitted with the model for a 0.38 mm diameter ideal nozzle. This characterization work is done for different settings of the metering valve. Figure 4 shows that it is possible to simulate a range of equivalent ideal nozzle diameters between 0.35 mm and 0.75 mm.

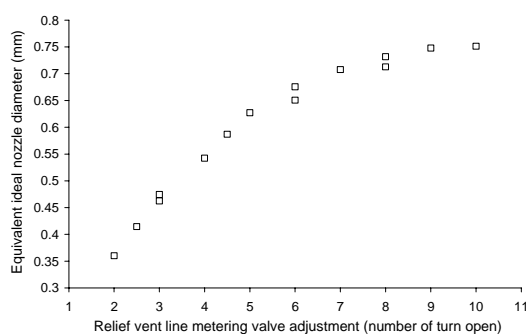

Figure 4. Equivalent ideal nozzle diameter for the relief vent line

3.2 Addition of a vented mass measurement system

The vented mass measurement device is composed of a glass column (1 m high, 5 cm inner diameter) partially filled with water. The outlet of the relief vent line is immersed into the water column. A differential pressure transducer (0-100 mbar) is connected to the bottom of the column.

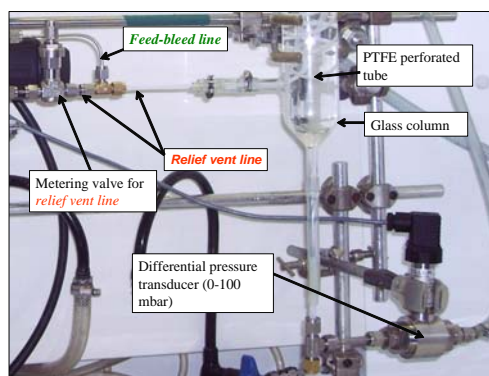

Figure 5. Picture of vented mass measurement system

During relief, chemical products are vented through the column (quench of the reaction is realized at the same time). Gas is ejected while liquid and condensable matters are collected at

the top of the water. This leads to an increase of the hydrostatic pressure at the bottom of the column. Flow from the relief vent line is transferred to the water column through a PTFE perforated tube in order to obtain small bubbles. It allows reducing perturbations on pressure measurement.

Assuming that vented chemical mixture is not miscible with water, $\Delta P_{measured}$ is translated to vented mass measurement (Δm) through the following formula:

$$\Delta m = \rho_{mixture} \Delta h_{mixture} A_{column} = A_{column} \left(\frac{\Delta P_{measured} - \Delta P_0}{g} \right) \quad (9)$$

$\rho_{mixture}$: chemical mixing density

$\Delta h_{mixture}$: height of vented chemical mixing

A_{column} : glass column cross section

ΔP_0 : initial differential pressure (due to the water)

The fraction of initial mass which is vented ($\Delta m/m_0$) is given by:

$$\frac{\Delta m}{m_0} = \frac{A_{column}}{m_0} \left(\frac{\Delta P_{measured} - \Delta P_0}{g} \right) \quad (10)$$

3.3 Adaptation of VSP2 to blow-down experiments

Standard DIERS tests with untempered systems are generally done with open cells. Blow-down tests can give higher pressure rise rates (we observed 15 bar/s for 30% cumene hydroperoxyde solution). To avoid test cell swelling, nitrogen pressure rise rate in the VSP2 containment vessel has to be improved.

For the standard set up, nitrogen supply is done by the mean of a high pressure cylinder (200 bar, 50 litres) connected to a pressure regulator (outlet pressure set at 70 bar). Maximal pressure rise rate we obtained with this configuration is approximately 6 bar/s. In order to increase containment vessel pressure rise rate, we connected a second nitrogen cylinder (50 litres) to the outlet of the pressure regulator. The pressure of this latter cylinder is fixed by the pressure regulator (70 bar). This device provides quasi-constant pressure at the outlet of the pressure regulator and we could increase containment vessel pressure rise rate up to 15 bar/s.

Test cell pressure decrease when vent opens can also be very rapid. The maximal pressure decrease rate obtained with the standard set-up was not always enough to avoid test cell crushing. We added a secondary containment vessel emptying line (1/4" stainless steel tube) to solve this problem. Pressure decrease rate was changed from - 0.2 bar/s to - 4.5 bar/s when $P_2 = 10$ bar.

4. Test of the “similarity vent sizing tool”: CHP runaway experiments

The new vent sizing device was tested by running non tempered system runaway experiments. The decomposition of cumene hydroperoxide (CHP), which produces non condensable gases, was chosen.

4.1 Chemical system and runaway scenario

80% (w/w) CHP solution in cumene is diluted in a high boiling point solvent: 2,2,4-trimethyl-1,3-pentanediol diisobutyrate. High boiling point of both peroxide and solvent is the criterion which allowed us to consider this system as untempered (CHP: $T_{bp} = 116^\circ\text{C}$ at $P = 0.02$ bar, solvent: $T_{bp} = 280^\circ\text{C}$ at $P = 1$ bar). The composition of the chemical system is (w/w): 30% CHP, 7.5% cumene, 62.5% 2,2,4-trimethyl-1,3-pentanediol diisobutyrate. A temperature increase rate of $0.5^\circ\text{C}/\text{min}$ simulates a fire scenario.

4.2 Experiment running steps

Blowdown experiments running step are the following:

- Assembly of the test cell according to VSP2 documentation.
- Vent line characterization (Figure 3)

- Filling of reactant in test cell
- Feed-bleed line opening
- *Guard heater* activation (will always be activated to limit heat losses)
- Heating of the sample 20°C → SADT + 5°C (= 85°C) by *main heater*
- Fire simulation : from 85°C heating of the sample at 0.5°C/min (constant heating power until the end of the runaway reaction)
- *Relief vent line* opening when test cell pressure reaches set pressure ($P_s = 4.5$ bar).

4.3 Results

Figure 6 presents a 30% CHP runaway experiment with similarity vent sizing tool. Test cell pressure (P1) and liquid temperature (T1) histories are plotted. The experimental conditions are:

- Initial reactant mass: 79 g
- Test cell volume = 125 cm³
- Initial fill level = 65% (v/v)
- Relief vent line : $A/V = 1.36 \times 10^{-3} \text{ m}^{-1}$ (3 turns opened)
- Feed bleed line metering valve = 3/8 turn opened

The whole experiment lasts approximately 3 hours. The runaway period is relatively short (a few minutes). Figure 7 shows a zoom for pressure, temperature and vented mass profiles during the relief period for the same runaway experiment. Time zero corresponds to relief vent line opening. We can observe two pressure peaks which is typical for untempered systems. The first one, corresponding to relief vent line opening, has no obvious influence on temperature profile. This behavior confirms that the chemical system is untempered. Dynamic vented mass measurement could be made. 20.4% of initial mass was vented at turn-around for that particular experiment.

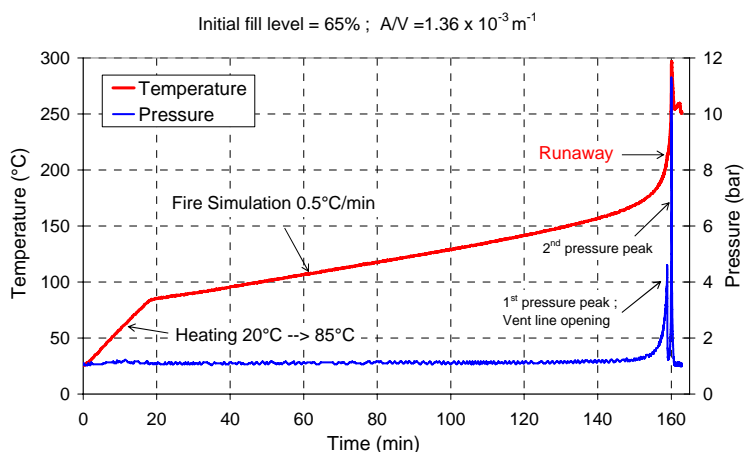

Figure 6. Whole 30% CHP runaway experiment with test cell blowdown

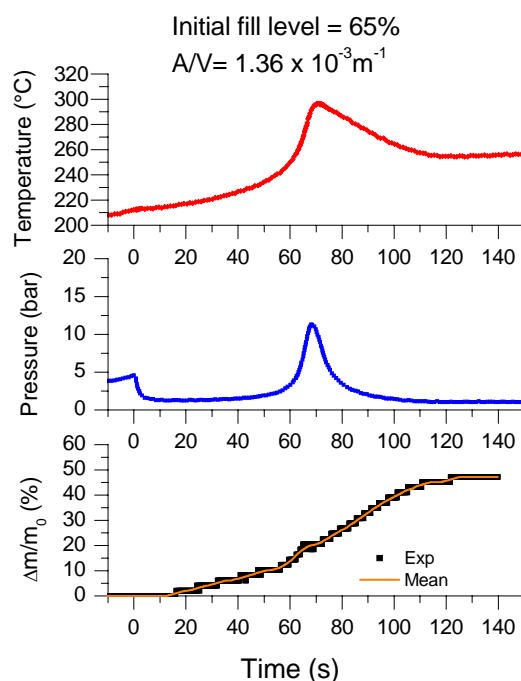

Figure 7.30% CHP runaway experiment: relief period (time 0 corresponds to relief vent line opening)

4.4 Limits of the new vent sizing tool

The following technical limits have been observed:

- Working with concentrated peroxide (>30% CHP or example) can lead to test cell failure, volume swell (A/V uncertainty).
- Limited range of equivalent ideal nozzle diameter can be simulated (0.35 mm - 0.75 mm).
- Using a metering valve is convenient (easy to change A/V) but not ideal: need to characterize vent line before each experiment because of aging.
- When initial fill level is higher than 80 %, liquid enters feed bleed line (which is supposed to vent only gas).

Technical solutions will be introduced in the future to solve these problems.

5. Conclusions and perspectives

A new similarity vent sizing tool combining the advantages of both DIERS method (laboratory scale) and UN method (less overconservative) has been built by extending VSP2 adiabatic calorimeter. This tool allows blow-down experiments to be carried out at laboratory scale. It was tested with CHP in 2,2,4-trimethyl-1,3-pentanediol diiso-butylate.

Dynamic mass vented measurement have been obtained. That is the second main point of the new tool. Taking this vented mass into account can sometimes account for DIERS oversizing by a factor of two.

However the following work has to be done to improve the capacity of the new tool:

- Improvement of vented mass measurement resolution
- Extension of equivalent diameter range by increasing the relief line size
- Use of calibrated orifices to have a better assessment of relief vent line and feed bleed line equivalent diameter
- Reduction of heat losses in order to allow for adiabatic tests.

An upcoming paper will deal with discussion of vented mass measurements and specific behaviour of CHP system. It will allow for a discussion of possible causes for DIERS method being so much oversizing.

Nomenclature:

A :	Ideal nozzle equivalent area (m^2)
G :	Critical vent mass flux ($kgm^{-2}.s^{-1}$)
m :	Reactant mass in the vessel (kg)
m_g :	Gas mass (kg)
•	
\dot{m} :	Mass flow (kg/s)
•	
\dot{m}_g :	Specific gas generation rate ($kg_{gas}.kg^{-1}.s^{-1}$)
M_{wg} :	Molecular weight of the gas (kg/mole)
P :	Pressure (Pa)
P_1 :	Pressure in the test cell (Pa)
P_2 :	Pressure in the containment vessel (Pa)
P_{atm} :	Atmospheric pressure (bar)
P_{max} :	Pressure at turnaround (bar)
P_s :	Vent opening pressure (bar)
T :	Temperature (K)
v_g :	Gas specific volume inside vessel ($m^3.kg^{-1}$).
v_i :	Specific volume at vent inlet ($m^3.kg^{-1}$)
v_l :	Liquid specific volume ($m^3.kg^{-1}$).
V_c :	Containment vessel volume (m^3)
V_g :	Volume of gas in the reactor (m^3)
W :	Vented mass flow ($kg.s^{-1}$)
x_i :	Vent inlet flow gas mass fraction
Δm :	vented chemical mixture mass
Δh :	height of vented chemical mixture
ρ :	density ($kg.m^{-3}$)
ϕ :	adiabaticity factor

Subscripts

0:	Initial conditions
1:	Test cell
2:	Containment vessel
c:	Critical (sonic)
column:	Glass column
g :	Gas
HEM :	Homogeneous equilibrium model
hom:	Homogeneous vessel contents
i:	inlet
mixture:	vented chemical mixture
R:	reactor

References

- Fauske, H.K., 2000. Properly size vents for non reactive and reactive chemicals. Chemical Engineering Progress, 17-29
- Leung, J.C.; Fauske H.K., 1987. Runaway system characterization and vent sizing based on DIERS methodology. Plant/Operation Progress 6(2), 77-83
- Leung, J.C., 1995. Simplified Vent Sizing Methods Incorporating Two-Phase Flow. International symposium on runaway reactions and pressure relief design, AIChE 200-236
- UN, Appendix 5 of "Recommendations on the Transport of Dangerous Goods, Manual of Tests and Criteria" http://www.unece.org/trans/danger/publi/manual/manual_e.html

