



HAL
open science

Combining a recurrent neural network and a PID controller for prognostic purpose.

Ryad Zemouri, Rafael Gouriveau, Nouredine Zerhouni

► **To cite this version:**

Ryad Zemouri, Rafael Gouriveau, Nouredine Zerhouni. Combining a recurrent neural network and a PID controller for prognostic purpose.. PENTOM'09 - PErformances et Nouvelles TechnOlgies en Maintenance., Dec 2009, Autrans, France. pp.1-14. hal-00445707

HAL Id: hal-00445707

<https://hal.science/hal-00445707>

Submitted on 11 Jan 2010

HAL is a multi-disciplinary open access archive for the deposit and dissemination of scientific research documents, whether they are published or not. The documents may come from teaching and research institutions in France or abroad, or from public or private research centers.

L'archive ouverte pluridisciplinaire **HAL**, est destinée au dépôt et à la diffusion de documents scientifiques de niveau recherche, publiés ou non, émanant des établissements d'enseignement et de recherche français ou étrangers, des laboratoires publics ou privés.

Combining a recurrent neural network and a PID controller for prognostic purpose

A way to improve the accuracy of predictions

Ryad Zemouri⁽¹⁾, Rafael Gouriveau⁽²⁾, Nouredine Zerhouni⁽²⁾

⁽¹⁾ *Laboratoire d'Automatique du CNAM
2 Rue Conté, 75003 Paris, France
ryad.zemouri@cnam.fr*

⁽²⁾ *Institut FEMTO-ST, UMR CNRS 6174 - UFC / ENSMM / UTBM
Département Automatique et Systèmes Micro-Mécatronique (AS2M)
24, rue Alain Savary, 25000 Besançon, France
{rgourive, zerhouni}@ens2m.fr*

ABSTRACT. In maintenance field, prognostic is recognized as a key feature as the prediction of the remaining useful life of a system allows avoiding inopportune maintenance spending. Assuming that it can be difficult to provide models for that purpose, artificial neural networks appear to be well suited. In this paper, an approach combining a Recurrent Radial Basis Function network (RRBF) and a proportional integral derivative controller (PID) is proposed in order to improve the accuracy of predictions. The PID controller attempts to correct the error between the real process variable and the neural network predictions. The approach and its performances are illustrated by using two classical prediction benchmarks: the Mackey–Glass chaotic time series and the Box–Jenkins furnace data.

RÉSUMÉ. Le processus de pronostic est considéré comme clef dans les stratégies de maintenance : l'estimation du temps résiduel avant défaillance permet d'éviter des dépenses de maintenance inutiles. Il peut cependant être difficile d'établir des modèles formels de pronostic, et les réseaux de neurones s'avèrent ainsi bien adaptés pour supporter l'étape de prédiction. Dans ce papier, une approche combinant un réseau de neurones récurrent à fonctions de base radiales (RRBF) et un régulateur proportionnel intégral dérivé (PID) est proposée. Le PID vise la correction de la sortie du RRBF et permet ainsi d'améliorer la précision des prédictions. L'approche est illustrée sur deux benchmarks classiques de prédiction : la série temporelle chaotique de Mackey–Glass et la série dite de Box–Jenkins.

KEYWORDS: Maintenance, prognostic, error of prediction, neural network, RRBF, PID.

MOTS-CLÉS : Maintenance, pronostic, erreur de prédiction, réseau de neurones, RRBF, PID.

1. Introduction

The high costs in maintaining complex equipments make necessary to enhance maintenance support systems and traditional concepts like preventive and corrective strategies are progressively completed by new ones like predictive and proactive maintenance (Muller *et al.*, 2008). Thereby, prognostic is nowadays considered as a key feature in maintenance strategies as the estimation remaining useful life of a system allows avoiding inopportune spending.

A central problem can be pointed out: the accuracy of a prognostic system is related to its ability to approximate and predict the degradation of the equipment: starting from a "current situation", a prognostic tool must be able to forecast the "future possible situations". From the research point of view, many developments exist to support these prognostic or forecasting activities ((De Gooijer *et al.*, 2006), (Jardine *et al.* 2006), (Vachtsevanos *et al.* 2006)). However, choosing an efficient technique depends on classical constraints that limit the applicability of the tools: available data-knowledge-experiences, dynamic and complexity of the system, implementation requirements (precision, computation time, etc.), available monitoring devices... Also, it can be difficult to provide effective models of dynamic systems including the inherent uncertainty of prognostic. That said, developments of this paper are founded on the following two complementary assumptions. 1) On one hand, real systems increase in complexity and their behaviour is often non-linear, which makes harder a modelling step, even impossible. 2) On the other hand, in many cases, it is not too costly to equip dynamic systems with sensors, which allows gathering real data online. According to all this, artificial neural networks (ANN) appear to be very promising prognostic tools: they learn from examples and attempt to capture the subtle relationship among data. They are computationally effective techniques and are thereby well suited for practical problems, where it is easier to gather data than to formalize the behaviour of the system being studied. Actual developments confirm the interest of using ANNs in forecasting applications (Zhang *et al.*, 1998).

In this context, the purpose of the work is to propose an ANN as a predictive tool for prognostic purpose and to improve its prediction accuracy. More precisely, the approach combines a Recurrent Radial Basis Function network (RRBF) and a proportional integral derivative controller (PID). The PID controller attempts to correct the error between the real process and the neural network predictions.

The paper is organized in three main parts. First, the concept of "prognostic" is clarified and replaced within maintenance strategies, and the relationship between prognostic and prediction is also explained; the efficiency of a prognostic system is highly dependent on its ability to perform "good" predictions. Then, the use of artificial neural networks for prognostic is justified and the ways of building such models are briefly discussed. Following that, the RRBF is proposed for prognostic. In the third part, a combination of this tool with a PID controller is developed to perform accurate predictions and the whole is illustrated on benchmark problems.

2. Prognostic framework and prediction

2.1. From maintenance to prognostic

Maintenance activity combines different methods, tools and techniques to reduce costs while increasing reliability, availability and security of equipments. Thus, one usually speaks about fault detection, failures diagnosis, and response development (choice and scheduling of preventive/corrective actions). Briefly, these steps correspond to the need, firstly, of "perceiving" phenomena, secondly, of "understanding" them, and finally, of "acting" consequently. However, rather than understanding a phenomenon which has just appeared like a failure (*a posteriori* comprehension), it is convenient to "anticipate" its manifestation in order to take adequate actions as soon as possible. This is what can be defined as the "prognostic process" and which the object of this paper is.

Industrials show a growing interest in prognostic which becomes a major research framework; see recent papers dedicated to condition-based maintenance ((Jardine *et al.*, 2006)). The relative positioning of detection, diagnosis, prognostic and decision / scheduling in the maintenance framework is schematized in Fig. 1a. From the phenomenological point of view, the complementarities of detection, diagnosis and prognostic can be explained as follows (see Fig. 1b): 1) detection aims at identifying the functioning mode of the system, i.e., its current state, 2) assuming that a failure occurred, diagnosis enables to isolate and identify the component that has ceased to operate (past propagation: from effects to causes), 3) prognostic deals with the prediction of the future(s) state(s) of the system (future propagation: from causes to effects).

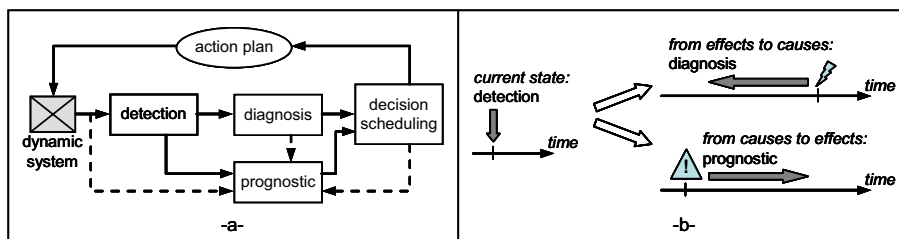

Figure 1. Prognostic within maintenance strategies

2.2. From prognostic to prediction

Although there are some divergences in literature, prognostic can be defined as proposed by the International Organization for Standardization: "prognostic is the estimation of time to failure and risk for one or more existing and future failure modes" (ISO 13381-1, 2004). Prognostic is also a process whose objective is to

predict the remaining useful life (RUL) before a failure occurs given the current machine condition and past operation profile (Jardine *et al.*, 2006). Two salient aspects of prognostic appear (Dragomir *et al.* 2007): (1) prognostic is mostly assimilated to a prediction process (a future situation must be caught), (2) prognostic is based on the failure notion, which implies that it is associated with a limit of acceptability (the predicted situation must be assessed with regard to a referential).

A central problem can be pointed out: the accuracy of a prognostic system is related to its ability to approximate and predict the degradation of an equipment; the prediction phase is a critical one. A look at prognostic metrics enables to point it out.

2.3. Prognostic metrics

There is no general agreement as to an appropriate and acceptable set of metrics that can be employed in prognostic applications, and researchers and maintenance practitioners are still working on this (Vachtsevanos *et al.*, 2006). Various measures emerge however from literature and are presented hereafter. As for any industrial task, prognostic can be evaluated at least in two ways:

- the main objective of prognostic is to provide the efficient information that enables the underlying decision process, i.e., the choice of maintenance actions. Thus, a first set of metrics are those that quantify the risks incurred by the monitored system. This kind of metrics can be called the **prognostic measures**,
- assuming that prognostic is in essence an uncertain process, it is useful to be able to judge from its "quality" in order to imagine more suitable actions. In this way, **prognostic system performance measures** can be constructed.

2.3.1. Prognostic measures

As mentioned earlier, the main prognostic measure pursued is the predicted time to failure (**TTF**), also called the remaining useful life (**RUL**). In addition, a **confidence** measure can be built to indicate the degree of certitude of the future predicted failure time. By extension, and considering that practitioners can be interested on assessing the system with regard to any performance limit, **RUL** and **confidence** can be generalized: in Fig. 2a, **TT_{xx}** refers to the remaining time to overpass the performance limit Perf/xx, and **Conf/xxT** is the confidence with which can be taken the asset $TT_{xx} > T$.

2.3.2. Prognostic system performance measures

The **timeliness** of the predicted time to failure (TTF) is the relative position of the probability density function (pdf) of the prediction model along the time axis with respect to the occurrence of the failure event. This measure evolves as more data are available and reveals the expected time to perform preventive actions

(Vachtsevanos *et al.*, 2006) (see Fig. 2b). According to (Goebel *et al.*, 2005), one needs to define two different boundaries for the maximum acceptable late and early predictions. **Accuracy** measures the closeness of the predicted value to the actual one. It has an exponential form and is as higher as the error between the predicted value of TTF and the real one is smaller. **Precision** reveals how close predictions are grouped or clustered together and is a measure of the narrowness of the interval in which the remaining life falls. Precision follows from the variance of the predicted results for many experiments. Complementarity of accuracy and precision is illustrated in Fig. 2c.

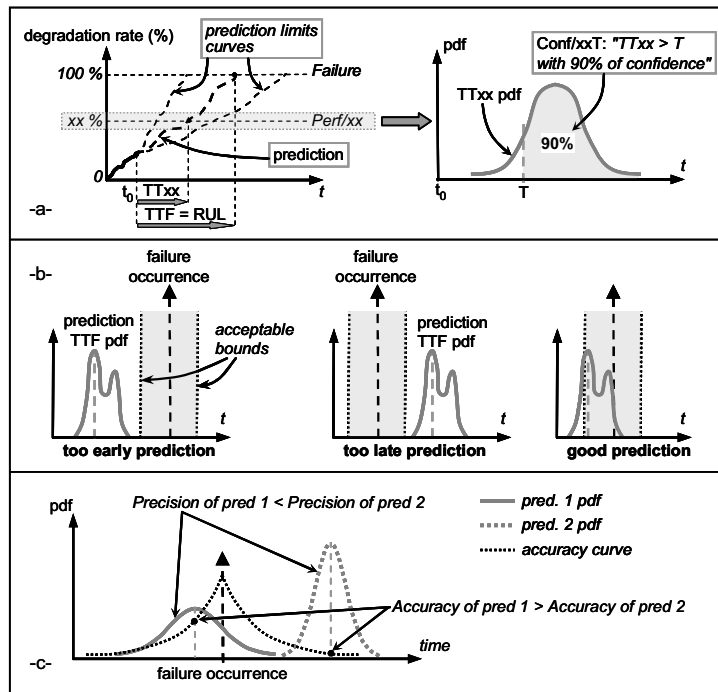

Figure 2. Some prognostic metrics

2.4. Perform good predictions: a critical issue

All prognostic metrics follow from the notion of "prediction": prognostic measures are themselves specific prediction measures and prognostic system performance measures can be seen as a way to assess the performances of the prediction in terms that can be interpreted by practitioners. As a synthesis, one should pay a particular attention to this prediction issue when choosing and adapting a prognostic tool. This aspect is developed in next sections.

3. The RRBF as a prediction tool for prognostic purpose

3.1. Prediction / forecasting approaches overview

According to some authors, the methods presented in this section are sometimes labelled as "prognostic techniques". However, most of them refer to what, in this paper, is called "prediction / forecasting". That said, the aim of this part is not to dress an exhaustive overview of prediction techniques but to explain the orientations of works that are taken.

Various prognostic approaches have been developed ranging in fidelity from simple historical failure rate models to high-fidelity physics-based models. These methods can be associated with one of the following two approaches, namely model-based and data-driven.

Model-based methods assume that an accurate mathematical model for the analyzed system / phenomenon can be constructed. The main advantage of these approaches is their ability to incorporate physical understanding of monitored system. Moreover, if the understanding of the system / phenomenon improves, the model can be adapted to increase its accuracy and to address subtle performance problems. But, this closed relation with a mathematical model may also be a strong weakness: it can be difficult, even impossible to catch the system's behaviour.

Data-driven approaches use real data (like on-line gathered with sensors or operator measures) to approximate and track features revealing the degradation of components and to forecast the global behaviour of a system. Indeed, in many applications, measured input/output data is the major source for a deeper understanding of the system degradation. Data-driven approaches can be divided into two categories: statistical techniques (statistical methods, linear and quadratic discriminators, partial least squares, etc.), and artificial intelligence techniques (neural networks, fuzzy systems, decision trees, etc.). The strength of data-driven techniques is their ability to capture subtle relationships among the data even if the underlying relationships are unknown or hard to describe (by a learning process).

3.2. Neural Networks – a fitted forecasting technique

Real systems are complex and their behaviour is often non linear, non stationary. These considerations make harder a modelling step, even impossible. Yet, a prediction computational tool must deal with it. Moreover, monitoring systems have evolved and it is now quite easy to online gather data. According to all this, data-driven approaches have been increasingly applied to prediction problems in general and to machine prognostic in particular. More precisely, research works emphasize on the interest of using artificial neural networks for prediction (Mandic *et al.*, 2001).

Artificial neural networks (ANNs) are a special case of adaptive networks that have been extensively explored in literature because of the following aspects. ANNs can perform nonlinear modelling without *a priori* knowledge: they are able to learn complex relationships among "inputs and outputs". Moreover, from the computational point of view, ANNs are quick processes.

ANNs have two typical connection architectures depending on the type of time representation (Elman, 1990): in feedforward networks (like the multi layers perceptron MLP or the radial basis function network RBF) time is represented as an external mechanism, whereas recurrent networks (like the Elman architecture or the recurrent radial basis function network RRBF) are able to treat time dimension without any external mechanism. Both have been employed in system behaviour forecasting.

One of the first successful application of ANNs in forecasting is reported by Lapedes and Farber (1987) who designed a feedforward ANN that can accurately mimic a chaotic series (Zhang *et al.*, 1998). In general, feedforward ANNs (MLP, RBF) trained with the backpropagation algorithm have been found to perform better than classical autoregressive models for the trend prediction of non linear time series.

In order to explicitly take into account the time in forecasting tools, backward networks architectures were also developed. These recurrent neural networks are fundamentally different from feedforward architectures in the sense that they not only operate on an input space but also on an internal state space. (Mandic *et al.*, 2001) provides a good overview of these networks. Recurrent ANNs were compared with some of the well known methods for the prediction of non-linear time series. The results indicated that RNNs have a better forecasting performance than the classical methods and are even better than the feedforward type ANNs.

In this paper, the recurrent radial basis function network (RRBF) proposed by (Zemouri *et al.*, 2003) is presented as a candidate for prognostic purpose.

3.3. RBF and Recurrent RBF networks

3.3.1. The Radial Basis Function network

The Radial Basis Function network (RBF) is a two layers feedforward network with an architecture similar to that of the two-layer Multi Layer Perceptron MLP (see Fig. 3.a).

The distance between an input vector and a prototype vector determines the activation of the hidden layer with the nonlinearity provided by the basis functions. Nodes in the output layer usually perform an ordinary linear weighted sum of these activations.

Mathematically, the network output for linear output nodes is expressed as follows:

$$y_k = \sum_{j=1}^M w_{kj} \phi_j(\|\mathbf{x} - \mathbf{u}_j\|) \quad [1]$$

where \mathbf{x} is the input vector with elements x_i (with i is the dimension of the input vector), \mathbf{u}_j is the vector determining the centre of the basis function ϕ_j with elements u_{ji} and w_{kj} are the final layer weights. The Gaussian basis function $\phi_j(\cdot)$ provides the nonlinearity of the neural network.

Training a RBF with linear outputs is very fast and is accomplished through two stages:

- the first stage is unsupervised and accomplished by obtaining cluster centres of the training set input vectors. A popular method for that purpose is *k-means* clustering,
- the second stage consists in solving a set of linear equations, the solution of which can be obtained by a matrix inversion technique such as singular value decomposition or least squares method.

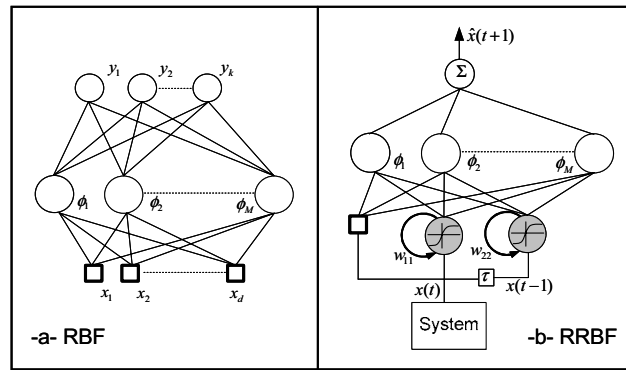

Figure 3. Radial Basis Function and Recurrent Radial Basis Function networks

3.3.2. The Recurrent Radial Basis Function network

The Recurrent RBF neural network considers time as an internal representation (Fig. 3.b). The dynamic aspect is obtained by the use of an additional self-connection to the input neurons with a sigmoid activation function. The RRBF network can thus take into account a certain past of the input signal.

Combining a recurrent neural network and a PID controller for prognostic purpose

Every neuron of the input layer gives a summation at the instant t between its input x_i and its previous output weighted by a self-connection w_{ii} . The output of its activation function is:

$$a_i(t) = w_{ii}\xi_i(t-1) + x_i(t), \quad \xi_i(t) = f(a_i(t)) \quad [2]$$

where $a_i(t)$ and $\xi_i(t)$ represent respectively the neuron activation and its output at the instant t , and f is the sigmoid activation function defined as $f(x) = (1 - \exp(-kx)) / (1 + \exp(-kx))$.

4. Combining a RRBF and a PID controller for prognostic purpose

4.1. Principle

RRBF appears to be a good candidate for prediction in prognostic applications. Nevertheless, one can improve its prediction accuracy by combining it with a proportional integral derivative controller (PID). Consider the prediction structure proposed in Fig. 4 to explain the principle of this procedure.

This prediction structure (let call it the RRBF_{Error}) is composed of a RRBF whose output is, for an horizon of prediction $t = 1$:

$$\hat{x}'(t+1) = \sum_{j=1}^M (w_{kj} \phi_j(\|\mathbf{x} - \mathbf{u}_j\|)) \quad [3]$$

At any time t , the error of prediction of this RRBF can be expressed as $\varepsilon(t) = x(t) - \hat{x}'(t)$ where $x(t)$ represents the real system output, and $\hat{x}'(t)$ the neural network predicted output. The aim of the PID is to apply a corrective action on this error. The output of the global prediction structure RRBF_{Error} is then defined as:

$$\hat{x}(t+1) = \hat{x}'(t+1) + K_p \varepsilon(t) + K_i \int_0^t \varepsilon(\tau) d\tau + K_d \frac{\partial \varepsilon(t)}{\partial t} \quad [5]$$

where, K_p , K_i , K_d are the proportional, integral and derivate gains of the PID.

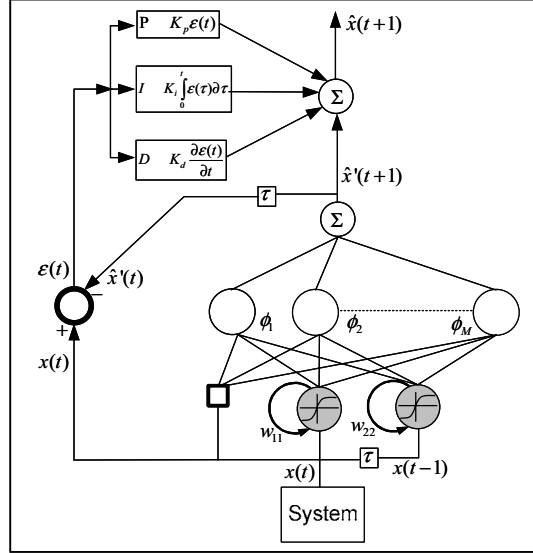

Figure 4. The $RRBF_{Error}$ structure for time series prediction

4.2. Data benchmarks and simulation conditions

Two real experimental data sets have been used to test the prediction performances of the $RRBF_{Error}$ structure with regards to the classical RRBFB network. In both cases, the aim of the predictions is to approximate a phenomenon by learning data gathered from the system. The first data set is the chaotic Mackey-Glass time series data (Glass *et al.*, 1988). This time series is a benchmark problem extensively used: it's a non periodic and non convergent time series. Considering our final applicative objective (the prognostic of failures), to be capable to carry out predictions on such a signal is of good omen: real systems are complex and have generally a nonstationary and non-linear behaviour, what makes difficult a modelling phase. Tests on this time series aim at predicting future values $y(t+n)$ by using past values. The second benchmark is that of Box-Jenkins furnace data (Box *et al.*, 1970). There are originally 296 data samples $\{y(t), u(t)\}$, from $t=1$ to $t=296$. From the real process, CO2 concentration is considered as the output of the model $y(t)$, and gas flow rate as the input $u(t)$. Tests on this time series aim at predicting future values $y(t+n)$ by using $\{y(t), u(t)\}$ values as inputs.

The same training and testing data sets were used to train and test both models RRBFB and $RRBF_{Error}$. For both benchmarks, 50 samples were used for training. Predictions were made from " $t+1$ " to " $t+10$ " by increments of 1 (in order to measure the stability of results in time). Predictions were performed with two past inputs at a step time " t " and " $t-1$ " (Fig. 4). The prediction performance was assessed by using the mean square error (MSE).

Combining a recurrent neural network and a PID controller for prognostic purpose

All data have been normalized by range $[-1,+1]$. With both data sets, the initial tests attempted to find the best RRBFF and RRBFF_{Error} model when evaluated with the corresponding test sets. In every case, the two neural models have been created with varying numbers of basis functions from 2 to 50 nodes. The basis width parameter was fixed to 1. The PID parameters (K_p, K_i, K_d) were varied from 0 to a maximum of 1 by increments of 0.1. While it is appreciated that values used for this scaling variable are extremes, these values have been chosen to encapsulate all possibilities.

4.3. Results and discussion

Results in Table 1 as well as Fig. 5 show the best overall MSEs obtained for Mackey-Glass and Box-Jenkins data sets. For all tests, best results are obtained with the integrator parameter $K_i=0$. This can be explained by the summation done by the integrator that gives an increasing prediction error at each step.

Horizon of prediction (t+n)	Neural Network	Mackey-Glass results				Box-Jenkins results					
		No. nodes	K_p	K_i	K_d	MSE test set	No. nodes	K_p	K_i	K_d	MSE test set
t+1	RRBF	4	-	-	-	1.1234558e-002	16	-	-	-	9.2346585e-003
	RRBF _{Error}	7	1	0	0.9	4.2470656e-005	10	0.8	0	0.5	2.4931081e-003
t+2	RRBF	4	-	-	-	3.1526859e-002	12	-	-	-	2.0891934e-002
	RRBF _{Error}	7	1	0	0.9	1.6468035e-003	9	0.5	0	1	1.3293116e-002
t+3	RRBF	2	-	-	-	4.6262829e-002	15	-	-	-	2.1827862e-002
	RRBF _{Error}	6	1	0	0.9	8.1336288e-003	31	0.7	0	0.5	1.8546084e-002
t+4	RRBF	2	-	-	-	6.4874782e-002	27	-	-	-	1.9543758e-002
	RRBF _{Error}	2	0.7	0	0.9	2.1463932e-002	16	0.2	0	0.2	2.1365814e-002
t+5	RRBF	2	-	-	-	8.5773478e-002	5	-	-	-	2.5234884e-002
	RRBF _{Error}	2	0.6	0	0.9	3.9283539e-002	6	0.8	0	0.9	2.1704984e-002
t+6	RRBF	2	-	-	-	1.0730872e-001	4	-	-	-	4.2036604e-002
	RRBF _{Error}	2	0.5	0	1	5.8869717e-002	7	0.4	0	0.1	3.7381127e-002
t+7	RRBF	2	-	-	-	1.2790076e-001	7	-	-	-	7.7557329e-002
	RRBF _{Error}	2	0.5	0	1	8.2871004e-002	6	0.5	0	0	7.5398560e-002
t+8	RRBF	2	-	-	-	1.4617843e-001	7	-	-	-	1.2138848e-001
	RRBF _{Error}	2	0.3	0	1	1.0340636e-001	4	0.3	0	0	1.1880591e-001
t+9	RRBF	2	-	-	-	1.6111025e-001	7	-	-	-	1.7708602e-001
	RRBF _{Error}	2	0.3	0	1	1.2357237e-001	8	0.5	0	0	1.5360799e-001
t+10	RRBF	2	-	-	-	1.7209771e-001	7	-	-	-	2.1988363e-001
	RRBF _{Error}	2	0.1	0	1	1.3818208e-001	5	0.6	0	0	1.7519635e-001

Table 1. Simulation results – bests MSEs obtained

Fig. 6 presents the MSE for different number of k centres of the Gaussian nodes at "t+1". According to this figure, the classical RRBFF network appears to be much more sensitive than the RRBFF_{Error} structure: this last has quite the same MSE for any k. Thus, the training process is easier and faster with the RRBFF_{Error} that is less dependent on the random initialization of the k-centres than the RRBFF model. It appears that the use of a PID allows avoiding the overtraining problem which occurs when the number of hidden neurons becomes greater than 25 for the Mackey-Glass time series data, and 15 for the Box-Jenkins furnace data. This interesting

relationship between the PID and the training problem will be studied in a closer manner in future research and will be hopefully formalized in interesting results.

Fig. 7 shows the prediction results obtained with the best model for each ANN for some prediction horizon (as presented in Table 1) on Mackey-Glass data. It is obvious that the prediction performances of the RRBF are highly improved with the proportional-derivative controller (PD controller). For the other benchmark tests (on Box-Jenkins), the prediction results obtained with the RRBF_{Error} are also better than those obtained with the RRBF network (but the figure is not included here).

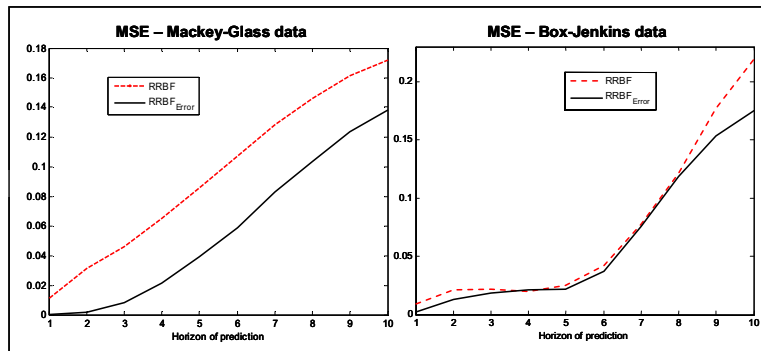

Figure 5. Bests MSEs obtained for both benchmarks at different prediction horizon

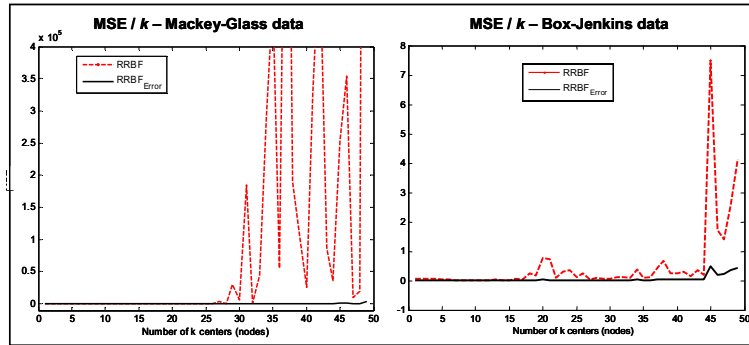

Figure 6. MSE with regards to the number of k centres at " $t+1$ "

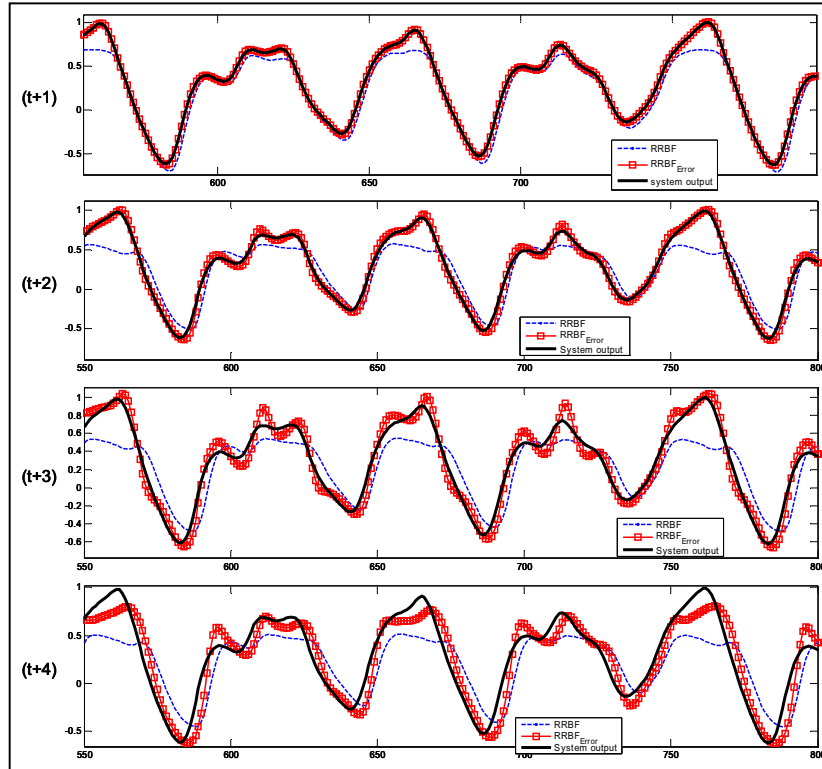

Figure 7. Mackey-Glass results for different horizons of prediction

5. Conclusions

In maintenance field, prognostic is recognized as a key feature as the estimation of the remaining useful life of an equipment allows avoiding inopportune maintenance spending. However, it can be difficult to define and implement an adequate and efficient prognostic tool that includes the inherent uncertainty of the prognostic process. Indeed, an important task of prognostic is that of prediction. In this context, the purpose of the work reported in this paper is to point out an accurate prediction technique and to propose a way to improve its prediction performances.

The concept of "prognostic" has been positioned within the maintenance strategies in order to point out the importance of the prediction phase in prognostic. According to the global requirements that can be expected from a forecasting tool, the neural network RRBFF has been presented as a candidate to support this activity. An improvement of this neural network has also been proposed by combining it with a proportional integral derivative controller (PID). The PID controller attempts to correct the error between the real process variable and the neural network

Ryad Zemouri, Rafael Gouriveau, Noureddine Zerhouni

predictions. Various simulations have been led with two benchmarks problems. Results show that the proposed prediction structure enables the forecasting to be a more robust task, without increasing complexity of treatments. The whole is of good omen for prognostic purpose.

Additional tests should be made to evaluate the performances of the proposed prediction structure in terms of prognostic (accuracy, precision). More investigation should also be led to study others ways to control the prediction error (for example with sophisticated nonlinear control approaches like fuzzy or neuro-controllers).

6. References

- Box G., Jenkins G., (1970) *Time series analysis: Forecasting and control*, San Francisco: Holden-Day
- De Gooijer J.G., Hyndman R.J., "25 years of time series forecasting", *International Journal of Forecasting*, vol. 22, 2006, p. 443-473.
- Dragomir O., Gouriveau R., Zerhouni N., Dragomir F., "Framework for a distributed and hybrid prognostic system", *4th IFAC Conference on Management and Control of Production and Logistics – MCPL'07*, Sibiu, Rumania, 2007.
- Elman J.L., "Finding Structure in Time", *Cognitive Science*, vol. 14, 1990, p. 179-211.
- Glass L. and M. C. Mackey, *From Clocks to Chaos, The Rhythms of Life*, (Princeton University Press,= Princeton, NJ, 1988).
- Goebel K., Bonissone P., "Prognostic information fusion for constant load systems", *Proceedings of 7th annual Conference on Fusion*, vol. 2, 2005, p. 1247-1255.
- ISO 13381-1, *Condition monitoring and diagnostics of machines - prognostics - Part1: General guidelines*, International Standard, ISO, 2004.
- Jardine A.K.S., Lin D., Banjevic D., "A review on machinery diagnostics and prognostics implementing condition-based maintenance", *Mechanical Systems and Signal Processing*, vol. 20, 2006, p. 1483-1510.
- Mandic D.P., Chambers J.A., *Recurrent Neural Networks for Prediction: Learning Algorithms and Architectures and Stability*, Chichester, John Wiley & Sons, 2001.
- Muller A., Suhner M.C., Iung B., "Formalisation of a new prognosis model for supporting proactive maintenance implementation on industrial system", *Reliability Engineering and System Safety*, vol. 93, 2008, p. 234-253.
- Vachtsevanos G., Lewis F.L., Roemer M., Hess A., Wu B., *Intelligent Fault Diagnosis and Prognosis for Engineering Systems*, Hoboken, New Jersey, Wiley & Sons, 2006.
- Zhang G., Patuwo B.E., Hu M.Y., "Forecasting with artificial neural networks: the state of the art", *International Journal of Forecasting*, vol. 14, 1998, p. 35-62.
- Zemouri R., Racoceanu D., Zerhouni N., "Recurrent Radial Basis Function network for Time-Series Prediction", *Engin. Appl. of Artificial Intelligence*, vol. 16, 2003, pp.453-463.