



HAL
open science

Object-level fusion and confidence management in a multi-sensor pedestrian tracking system

Fayad Fadi, Véronique Cherfaoui

► **To cite this version:**

Fayad Fadi, Véronique Cherfaoui. Object-level fusion and confidence management in a multi-sensor pedestrian tracking system. Lecture notes in Electrical Engineering, 2009, 35, pp.15-31. 10.1007/978-3-540-89859-7_2 . hal-00444904

HAL Id: hal-00444904

<https://hal.science/hal-00444904>

Submitted on 7 Jan 2010

HAL is a multi-disciplinary open access archive for the deposit and dissemination of scientific research documents, whether they are published or not. The documents may come from teaching and research institutions in France or abroad, or from public or private research centers.

L'archive ouverte pluridisciplinaire **HAL**, est destinée au dépôt et à la diffusion de documents scientifiques de niveau recherche, publiés ou non, émanant des établissements d'enseignement et de recherche français ou étrangers, des laboratoires publics ou privés.

Object-level fusion and confidence management in a multi-sensor pedestrian tracking system

Fadi FAYAD and Véronique CHERFAOUI

Heudiasyc UMR CNRS 6599, Université de Technologie de Compiègne
Centre de Recherche de Royallieu - BP 20529, 60205 Compiègne Cedex
Tel: +33 3 44 23 79 86, Fax: +33 3 44 23 44 77
emails: fadi.fayad@hds.utc.fr, veronique.cherfaoui@hds.utc.fr

Abstract This paper¹ describes a multi-sensor fusion system dedicated to detect, recognize and track pedestrians. The fusion by tracking method is used to fuse asynchronous data provided by different sensors with complementary and supplementary fields of view. Having the performance of the sensors, we propose to differentiate between the two problems: object detection and pedestrian recognition, and to quantify the confidence in the detection and recognition processes. This confidence is calculated based in geometric features and it is updated under the Transferable Belief Model framework. The vehicle proprioceptive data are filtered by a separate Kalman filter and are used in the estimation of the relative and absolute state of detected pedestrians. Results are shown with simulated data and with real experimental data acquired in urban environment.

Keywords multi-sensor data fusion, pedestrians' detection and recognition, Transferable belief Model, confidence management.

¹ This work is a part of the project LOVE (Logiciel d'Observation des Vulnérables <http://love.univ-bpclermont.fr/>) and supported by the French ANR PREDIT.

1. Introduction

Recent projects on pedestrian detection [1] or obstacle detection [2] have highlighted the use of multi-sensor data fusion and more generally the multiplication of data sources in order to obtain more reliable, complete and precise data. The Vehicle to Vehicle communication is an example of enlarging the field of view of one vehicle by the information coming from other vehicles [3][4].

The work presented in this paper is a contribution to the development of an “Advances Driver Assistance Systems” (ADAS). A generic multi-sensor pedestrian detection, recognition and tracking system, is introduced. However, sensors are not synchronized and have not the same performance and field of view. Thus to explore the whole capability of sensors in order to benefit of all available data and to solve the problem of asynchronous sensors, we present a generic method to fuse data provided by different sensor, with complementary and/or supplementary fields of view, by tracking detected objects in a commune space and by combining the detection and/or the recognition information provided by each sensor taking into consideration its performance.

This paper is organized as follows: section II presents the proposed multi-sensor fusion system architecture and describes the object level fusion by tracking method. Section III described the state models used to filter and estimate vehicle and pedestrians’ kinematical state. Section IV presents the detection and recognition confidences calculation and update. Experimental results are shown in section V illustrating the effect of sensors performance. Conclusion and perspectives will be proposed in the last section.

2. Object-level fusion by tracking

2.1. Overview of the system

The described multi-sensor pedestrian tracking system is an in-vehicle embedded real-time system. This generic fusion system (Fig.1) has as input the unsynchronized data provided by independent unsynchronized sensors with complementary and supplementary fields of view (Fig.2).

The system is composed of one “Object Level Fusion Module” and one “Sensor Module” per sensor. Each Sensor Module analyzes data provided by the corresponding sensor to supply the Object Level Fusion Module by a list of objects supposed present in the scene of its field of view. A lot of works in ADAS and robotics applications are dedicated to the object detection capabilities. For example for pedestrian detection, [5] proposes obstacle detection and identification with Lidar sensor; [6] proposes stereo-vision obstacle detection with disparity analysis and SVM based on pedestrian classification, [7] gives pedestrian classification resulting from monocular vision with AdaBoost algorithm. The Object Level Fusion Module takes any ready object list and combine it with the existing track list, taking into consideration the vehicle proprioceptive data (filtered by a separate Kal-

man filter) and the performance of each detection module (stored in a configuration file with other tuning parameters). Latency problem can be solved by a time indexed buffer of observations and state vectors as in [8]. The buffer size depends on the maximum acceptable observation delay.

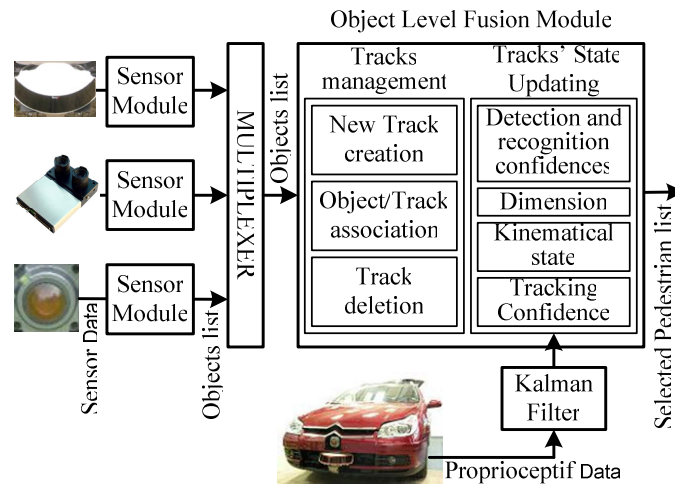

Fig.1: System architecture

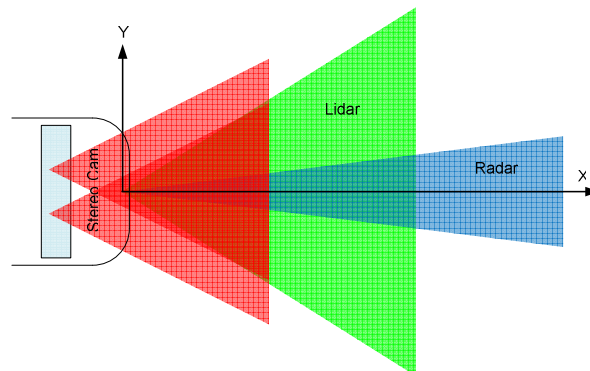

Fig.2: Complementary and supplementary fields of view of the different sensors: Stereo-camera, Lidar and Radar

2.2. Object level input/output

The Sensor Module works at the frequency of the corresponding sensor, it provides at each detection cycle a list of objects supposed present in the scene of its field of view. Objects are described by their position (relative to the sensor), position error, dimension (if detected), dimension error and two indicators quantifying the confidence in detection and the confidence in recognition if the sensor is capa-

ble to recognize pedestrians or any type of obstacles. The performance of each sensor module is quantified by two probability values: P_{FR} representing the probability of false pedestrian recognition and P_{FA} the probability of false alarm or false detection. Sensor performance is propagated to the object's detection and recognition confidences.

The Object Level Fusion Module has to run at the frequency of the incoming object lists. It has to combine any ready object list with the existing track list to provide a list of estimated tracks at the current time. Tracks are characterized by their relative position, position error, speed, speed error, dimension, dimension error and three indicators quantifying the confidences in detection, recognition and tracking.

To fuse data, all information is represented in the same 3D coordinate system ($X_L Y_L Z_L$) showed in Fig.3: the origin is the center of the Lidar reflection mirror and the plan ($X_L Y_L$) is parallel to the ground. A special calibration procedure is developed to project vision data into 3D coordinate system and vice versa.



Fig.3. Commune relative Lidar coordinate system.

2.3. Fusion by tracking

The Track's state is divided into four parts updated by four different processes (Fig.1) with the same update stages and models for all tracks:

1. Kinematical state (track's position and velocity) loosely-coupled with the vehicle state and updated by a classical Kalman filter detailed in section 3.
2. Tracking confidence: calculated and updated based on the score of Sittler using likelihood ratio [9]
3. Dimension: updated by a fixed gain filter taking into consideration the objects partial occultation problem [10]
4. Detection and recognition confidences: updated by a credibilistic model based on the belief functions and presented in section 4.

When the fusion and state updating module receive a list of object at its input, it predicts the last list of tracks' state to the current object list time, and then it runs

an object to track association procedure based on a modified version of the nearest neighborhood association method. This modified method takes into consideration the occultation problem by geometrically detecting the occultation areas and allowing multi-object to track association to associate all parts of a partially hidden object to the corresponding track.

3. Pedestrian model for in-vehicle tracking

3.1. Coordinate systems transformation

Let (o, \vec{i}, \vec{j}) be an absolute fixed coordinate system and (O, \vec{I}, \vec{J}) and $(O_L, \vec{I}_L, \vec{J}_L)$ be two relative coordinate systems attached respectively to the center of the rear wheel axle and the center of Lidar rotating mirror (Fig.4). The x-axis is aligned with the longitudinal axis of the car. Let M be a point of the space and let (x, y) , (X, Y) and (X_L, Y_L) be its respective Cartesian coordinate in the three systems. (X, Y) and (X_L, Y_L) are related by the equations:

$$\begin{cases} X = X_L + L \\ Y = Y_L \end{cases} \quad (1)$$

The geometry of Fig.4 shows that:

$$\begin{cases} \vec{oM} = \vec{oO} + \vec{OM} \\ \vec{oO} = x_o \vec{i} + y_o \vec{j} \\ \vec{OM} = X \vec{I} + Y \vec{J} \\ \vec{I} = \vec{i} \cos \theta + \vec{j} \sin \theta \\ \vec{J} = -\vec{i} \sin \theta + \vec{j} \cos \theta \end{cases} \quad (2)$$

Therefore:

$$\begin{cases} x = x_o + X \cos \theta - Y \sin \theta \\ y = y_o + X \sin \theta + Y \cos \theta \end{cases} \quad (3)$$

Then:

$$\begin{cases} X = (x - x_o) \cos \theta + (y - y_o) \sin \theta \\ Y = -(x - x_o) \sin \theta + (y - y_o) \cos \theta \end{cases} \quad (4)$$

The absolute speed vector of the point M is the derivative of its position vector:

$$\vec{v} = \frac{d\vec{oM}}{dt} = \frac{d\vec{oO}}{dt} + X \frac{d\vec{I}}{dt} + Y \frac{d\vec{J}}{dt} + \frac{dX}{dt} \vec{I} + \frac{dY}{dt} \vec{J} \quad (5)$$

Let $\vec{V} = (dX/dt) \vec{I} + (dY/dt) \vec{J}$ be the relative speed of M with respect to the vehicle coordinate system (O, \vec{I}, \vec{J}) and $\vec{v}_o = d\vec{oO}/dt$ be the absolute speed of O.

The derivatives of the vectors \vec{I} and \vec{J} are:

$$\begin{cases} d\vec{I}/dt = [(-\sin\theta)\vec{i} + (\cos\theta)\vec{j}]d\theta/dt \\ d\vec{J}/dt = [(-\cos\theta)\vec{i} + (-\sin\theta)\vec{j}]d\theta/dt \end{cases} \quad (6)$$

Let $\Omega = d\theta/dt$ be the absolute rotation speed of the vehicle around the point O, then (4) can be written as:

$$\vec{v} = \vec{V} + \vec{v}_o + \Omega \begin{bmatrix} -\sin\theta & -\cos\theta \\ \cos\theta & -\sin\theta \end{bmatrix} \begin{bmatrix} X \\ Y \end{bmatrix} \quad (7)$$

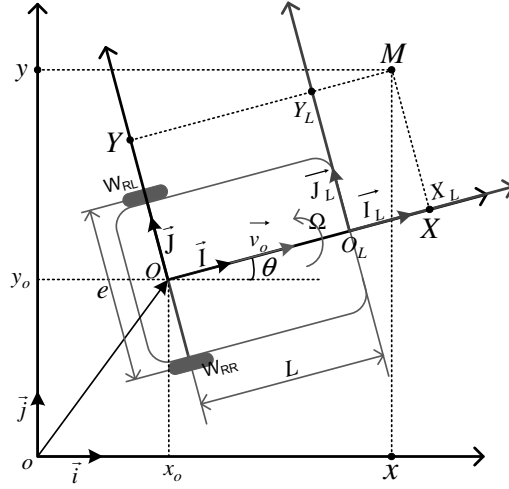

Fig.4. absolute and relative coordinate systems

3.2. Vehicle model

In modern cars, braking is assisted by ABS systems that use angular encoders attached to the wheels. In such a case, the sensors basically measure the wheel speeds. We propose in this paper to use this data to model vehicle movement and to estimate its kinematical state.

Fig.5 shows the elementary displacement of the vehicle between two samples at t_k and t_{k+1} . The presented car-like vehicle model is a real odometric model [11] and not the discretized kinematics model used in [12]. Assumptions are made on the elementary motions and geometric relationships are expressed to provide relations between the rotations of the wheels and the displacements. The rear wheels' speeds are read from the CAN bus of the experimental vehicle. They are supposed constants between two readings. On the assumption that the road is perfectly planar and the motion is locally circular, the vehicle's linear speed v_o and angular speed Ω can be calculated from the rear wheels speed as follow:

$$\begin{cases} v_o = (V_{RR} + V_{RL}) / 2 \\ \Omega = (V_{RR} - V_{RL}) / e \end{cases} \quad (8)$$

Where V_{RR} and V_{RL} represent respectively the rear right and left wheel speeds, and e is the distance between their points of contact with the road plane.

With the assumption of constant wheels speed between two CAN readings (with sampling time of T_e), the equations (7) prove that the linear and angular speeds are also constant; the vehicle state evaluation between the time t_k and $t_{k+1} = t_k + T_e$ can be written as:

$$\begin{cases} v_{o,k+1} = v_{o,k} \\ \theta_{k+1} = \theta_k + \Omega_k T_e \\ \Omega_{k+1} = \Omega_k \end{cases} \quad (9)$$

Where θ_k represents the absolute heading angle of the vehicle.

The vehicle state is filtered and estimated with a traditional Kalman filter having the state vector: $[v_o \quad \theta \quad \Omega]^T$ and the measurement vector: $[V_{RR} \quad V_{RL}]^T$

The model error covariance matrix is experimentally approximated based on the maximum error provided by the assumption of constant angular and linear speed model. The measurement error covariance matrix is calculated based on the ABS angular encoders' error.

3.3. Pedestrian model

Pedestrians are supposed moving linearly at constant speed. The evaluation of the absolute position (x, y) and speed (v_x, v_y) of a pedestrian, with respect to the coordinate system (o, \vec{i}, \vec{j}) , between the time t_k and t_{k+1} is:

$$\begin{cases} x_{k+1} = x_k + v_{x,k} T_e \\ y_{k+1} = y_k + v_{y,k} T_e \\ v_{x,k+1} = v_{x,k} \\ v_{y,k+1} = v_{y,k} \end{cases} \quad (10)$$

From the equation (2), (4), (5), (7) and (10) we calculated the relative position and velocity of a pedestrian with respect to the coordinate system (O, \vec{I}, \vec{J}) :

$$\begin{aligned} X_{k+1} &= X_k \cos(\Omega_k T_e) + Y_k \sin(\Omega_k T_e) - v_{o,k} T_e \cos(\Omega_k T_e / 2) \\ &\quad + v_{x,k} T_e \cos(\theta_k + \Omega_k T_e) + v_{y,k} T_e \sin(\theta_k + \Omega_k T_e) \\ Y_{k+1} &= Y_k \cos(\Omega_k T_e) - X_k \sin(\Omega_k T_e) + v_{o,k} T_e \sin(\Omega_k T_e / 2) \\ &\quad - v_{x,k} T_e \sin(\theta_k + \Omega_k T_e) + v_{y,k} T_e \cos(\theta_k + \Omega_k T_e) \\ V_{x,k+1} &= V_{x,k} + \Omega_k T_e (v_{y,k} - v_{o,k} \sin(\theta_k + \Omega_k T_e / 2)) \end{aligned} \quad (11)$$

$$V_{y,k+1} = V_{y,k} + \Omega_k T_e (-v_{x,k} + v_{o,k} \cos(\theta_k + \Omega_k T_e / 2))$$

Pedestrians state is filtered and estimated with a traditional Kalman filter (one filter per pedestrian) having the state vector: $[v_x \ v_y \ X \ Y \ V_x \ V_y]^T$

$$\text{and the measurement vector: } \begin{bmatrix} X \\ Y \end{bmatrix} = \begin{bmatrix} X_L + L \\ Y \end{bmatrix} \quad (12)$$

The model error covariance matrix is experimentally approximated based on the maximum error provided by the assumption of pedestrian constant speed model. The measurement error covariance matrix is calculated based on the sensor's resolution saved in a configuration file with other tuning parameters.

After updating the kinematical state by the Kalman filter, the next section will describe the update method used for the detection and the recognition confidences by a credibilistic model based on the belief functions.

4. Confidence indicators

4.1. Definition of pedestrian's confidence indicators

The objective of the system is the detection and the recognition of pedestrians. To quantify this goal, we defined two numerical indicators representing respectively the confidence in detection and in recognition. These indicators can be calculated, for example, based on statistical approaches or on geometrical features analysis. As an example, a calculation method of these indicators is described in [13] for the case of 4-planes Lidar.

4.2. Confidence indicators updating

4.2.1. TBM principle and notation

The transferable belief model TBM is a model to represent quantified beliefs based on belief functions [14]. It has the advantage of being able to explicitly represent uncertainty on an event. It takes into account what remains unknown and represents perfectly what is already known.

a) Knowledge representation

Let Ω be a finite set of all possible solution of a problem. Ω is called the frame of discernment (also called state space); it's composed of mutually exclusive elements. The knowledge held by a rational agent can be quantified by a belief function defined from the power set 2^Ω to $[0,1]$. Belief functions can be expressed in several forms: the basic belief assignment (BBA) m , the credibility function bel , the plausibility function pl , and the commonality function q which are in one-to-one correspondence. We recall that $m(A)$ quantifies the part of belief that is re-

stricted to the proposition “the solution is in $A \subseteq \Omega$ ” and satisfies:

$$\sum_{A \subseteq \Omega} m(A) = 1 \quad (13)$$

Thus, a BBA can support a set $A \subseteq \Omega$ without supporting any sub-proposition of A , which allows to account for partial knowledge. Smets introduced the notion of open world where Ω is not exhaustive; this is quantified by a non zero value of $m(\emptyset)$.

b) Information fusion

n distinct pieces of evidence defined over a common frame of discernment and quantified by BBAs $m_1^\Omega \cdots m_n^\Omega$, may be combined, using a suitable operator. The most common are the conjunctive and the disjunctive rules of combination denoted respectively \odot and \oplus , and defined by the equations (14) and (15).

$$\begin{aligned} m_\odot^\Omega(A) &= m_1^\Omega(A) \odot \cdots \odot m_n^\Omega(A) \\ &= \sum_{A_1 \cap \cdots \cap A_n = A} m_1^\Omega(A_1) \times \cdots \times m_n^\Omega(A_n) \quad \forall A \subseteq \Omega \end{aligned} \quad (14)$$

$$\begin{aligned} m_\oplus^\Omega(A) &= m_1^\Omega(A) \oplus \cdots \oplus m_n^\Omega(A) \\ &= \sum_{A_1 \cup \cdots \cup A_n = A} m_1^\Omega(A_1) \times \cdots \times m_n^\Omega(A_n) \quad \forall A \subseteq \Omega \end{aligned} \quad (15)$$

Obtained BBAs should be normalized in a closed world assumption.

The conjunctive and disjunctive rules of combination assume the independence of the data sources. In [15] and [16] Denoeux introduced the cautious rule of combination (denoted by \otimes) to combine dependent data. This rule has the advantage of combining dependent BBAs without increasing total belief: the combination of a BBA with itself will give the same BBA: $m = m \otimes m$ (idempotence property). The cautious rule of combination is based on combining conjunctively the minimum of the weighted function representing dependent BBAs.

c) Reliability and discounting factor

The reliability is the user opinion about the source [17]. The idea is to weight most heavily the opinions of the best source and conversely for the less reliable ones. The result is a discounting of the BBA m^Ω produced by the source into the new BBA $m^{\Omega, \alpha}$ where:

$$\begin{cases} m^{\Omega, \alpha}(A) = (1 - \alpha)m^\Omega(A), & \forall A \subseteq \Omega, A \neq \Omega \\ m^{\Omega, \alpha}(\Omega) = \alpha + (1 - \alpha)m^\Omega(\Omega) \end{cases} \quad (16)$$

The discounting factor $(1 - \alpha)$ can be regarded as the degree of trust assigned to the sensor.

d) Decision making

The couple (credibility, plausibility) is approximated by a measurement of probability by redistribute the mass assigned to each element of 2^Ω , different

from singleton, to the elements which compose it. The probability resulting from this approximation is called pignistic probability $BetP$; it's used for decision making:

$$\forall \omega \in \Omega \Rightarrow BetP^\Omega(\omega) = \sum_{A \in \mathcal{A} \subseteq \Omega} \frac{m^\Omega(A)}{|A|(1-m^\Omega(\emptyset))} \quad (17)$$

4.2.2. Confidence calculation

a) Defining the frames of discernment

Before defining any quantified description of belief with respect to the objects' detection and/or pedestrians' recognition, we must define a frame of discernment Ω on which beliefs will be allocated and updated.

For the objects detection problem, we can associate two general cases: object O and non object NO . The object can be a pedestrian or a non pedestrian object, but with no object identification, the frame of discernment of the object detection process is limited to: $\Omega_d = \{O, NO\}$. As an example, a disparity image analyzer of a stereo-vision system can have Ω_d as its frame of discernment.

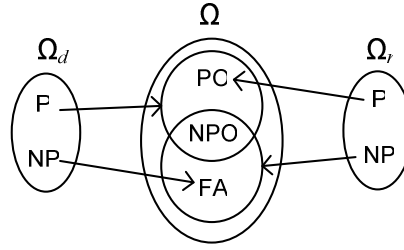

Fig.4. Relation between the state spaces of the detection and the recognition processes

A mono-vision pedestrian recognition process based on an AdaBoost algorithm for example, gives the probability of detecting a pedestrian P or non pedestrian NP . The non pedestrian can be a non pedestrian object or a false alarm. Let $\Omega_r = \{P, NP\}$ be the frame of discernment of this type of recognition processes.

The update stage requires a commune frame of discernment, let $\Omega = \{PO, NPO, FA\}$ be the frame containing all possible solutions of the detection and the recognition problem. The relation between the three frames Ω , Ω_d and Ω_r is represented in Fig.4.

Transforming BBAs from Ω_d and Ω_r to a more detailed frame, such as Ω , is called the refinement process and it's denoted \uparrow . The inverse transformation is called coarsening and it's denoted \downarrow [14].

b) Basic belief assignment calculation

The outputs of the detection and the recognition processes are Bayesian probability functions. With no additional information, we have to build, based on these probabilities, the basic belief assignments $m_{d,S_s,t_k}^{\Omega_d} \{O_i\}$ (BBA of the detection module of the object O_i detected by the source S_s and defined over the frame of discernment Ω_d at time t_k) and/or $m_{r,S_s,t_k}^{\Omega_r} \{O_i\}$ (BBA of the recognition module of O_i detected by S_s and defined over Ω_r at time t_k).

We are using the inverse pignistic probability transform proposed by Sudano [18] to calculate belief functions from Bayesian probability functions. So, to build the BBAs, we calculate from the probability functions the less informative BBAs who regenerate the same probability as its pignistic probability [19].

4.2.3. Confidence updating algorithm

The fusion and tracking module updates all tracks information such as track's state and track's detection and recognition confidences. The algorithm of track detection and recognition confidence update with object detection and recognition confidence consists in: (Fig.5)

- Transform the probabilities $P_{d,S_s,t_k} \{O_i\}$ and $P_{r,S_s,t_k} \{O_i\}$ into basic belief assignment BBAs: $m_{d,S_s,t_k}^{\Omega_d} \{O_i\}$ and $m_{r,S_s,t_k}^{\Omega_r} \{O_i\}$ (see section 4.2.2 b)
- Transform the performance of the sensor module into discounting values: the probability of false alarm P_{FA} and the probability of false recognition P_{FR} of the sensor module transform the last BBAs into $m_{d,S_s,t_k}^{\Omega_d,\alpha_d} \{O_i\}$ and $m_{r,S_s,t_k}^{\Omega_r,\alpha_r} \{O_i\}$ where $\alpha_d = 1 - P_{FA}$ and $\alpha_r = 1 - P_{FR}$ are respectively the discounting factors of the detection and the recognition processes (see equation 16).
- Transform beliefs from Ω_d and Ω_r to the commune frame of discernment Ω by doing the refinement process, i.e. moving the belief on a subset of Ω_d (respectively Ω_r) to the corresponding subset of Ω . We get: $m_{d,S_s,t_k}^{\Omega_d \uparrow \Omega, \alpha_d} \{O_i\}$ and $m_{r,S_s,t_k}^{\Omega_r \uparrow \Omega, \alpha_r} \{O_i\}$ (see section 4.2.2 a).
- The two obtained BBAs are not really independent because they are calculated in a sensor module based on the same data set. We decided to combine them using the cautious rule of combination, which take into consideration the dependency in data (See section 4.2.1 b):

$$m_{dr,S_s,t_k}^{\Omega} \{O_i\} = m_{d,S_s,t_k}^{\Omega_d \uparrow \Omega, \alpha_d} \{O_i\} \oslash m_{r,S_s,t_k}^{\Omega_r \uparrow \Omega, \alpha_r} \{O_i\}$$

- We suppose the temporal independency of data provided by a sensor, thus the obtained BBA is combined conjunctively (using equation 14) with the associ-

ated track belief function $m_{i_{k-1}}^\Omega \{T_j\}$ to get $m_{i_k}^\Omega \{T_j\}$ as result of the combination and update process:

$$m_{i_k}^\Omega \{T_j\} = m_{dr, S_s, t_k}^\Omega \{O_i\} \odot m_{i_{k-1}}^\Omega \{T_j\}$$

- Finally, the track's detection and recognition confidence $P_{d, j_k} \{T_i\}$ and $P_{r, j_k} \{T_i\}$ are the pignistic probability *BetP* calculated from $m_{i_k}^\Omega \{T_j\}$ (see section 4.2.1 d).

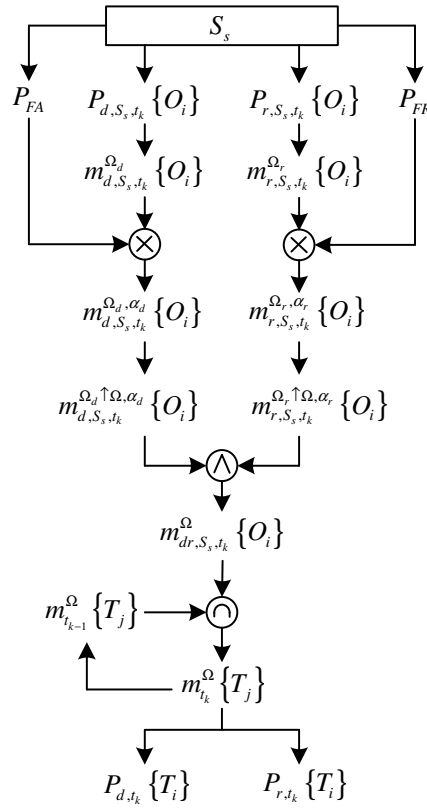

Fig.5. Confidence updating algorithm.

5. Results

5.1. Simulation results

To show the effect of the proposed confidence updating method with two sensors with different reliabilities, we simulated the data coming from two unsynchronized sensors. Results shows that with constant object detection and recognition confidences, the more reliable sensor dominates.

in Figure (Fig.6), the sensor 1 is reliable in detection with a probability of false detection of 20%, but not in recognition (80% false recognition) and the sensor 2 is reliable in recognition (20% false recognition) but not in detection (80% false detection): fusion results shows that the corresponding track is well detected and recognized. Figure (Fig.7) shows the inverse case: the track detection and recognition confidences go down to zero with the low confidences in detection and recognition given by the reliable sensors.

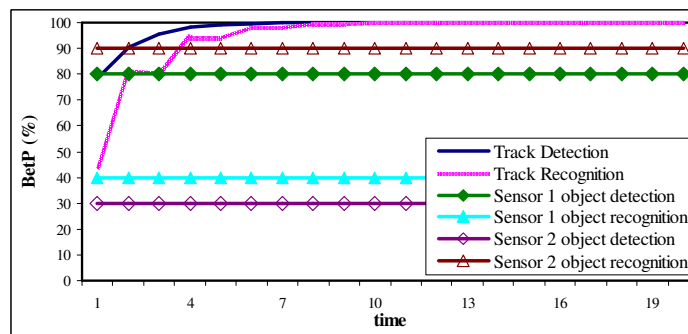

Fig.6. Track detection and recognition with two sensors: confidences follow the powerful sensor up to 100%

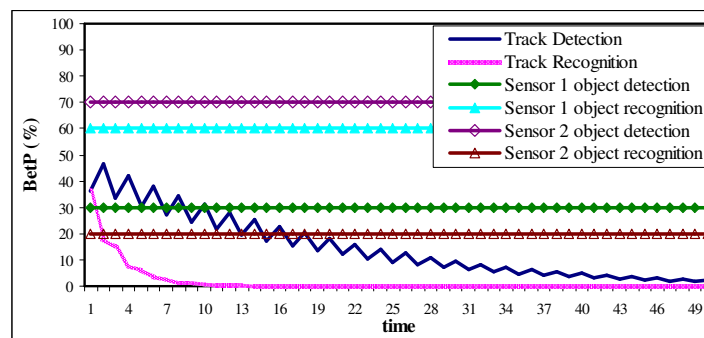

Fig.7. Track detection and recognition with two sensors: confidences follow the powerful sensor down to 0%

5.2. Experimentations

The algorithms are tested as a real time embedded system implemented in the experimental vehicle CARMEN (Fig.3) of the laboratory Heudiasyc. CARMEN is equipped with different sensors such as 4-plans Lidar, stereo and mono cameras and radar. Proprioceptive data, such as wheels speed, is read from the vehicle CAN bus. Only Lidar and proprioceptive data are used in this experiment while image data provided by cameras is used to validate results by projecting laser data, tracks and confidences on the corresponding image (Fig.8). Experimentations are done in an urban environment.

To simulate two unsynchronized sensors with different performance, Lidar data are assigned at each scanning period to one of two virtual Lidars having different detection and recognition confidences but the same measurement precision as the real Lidar.

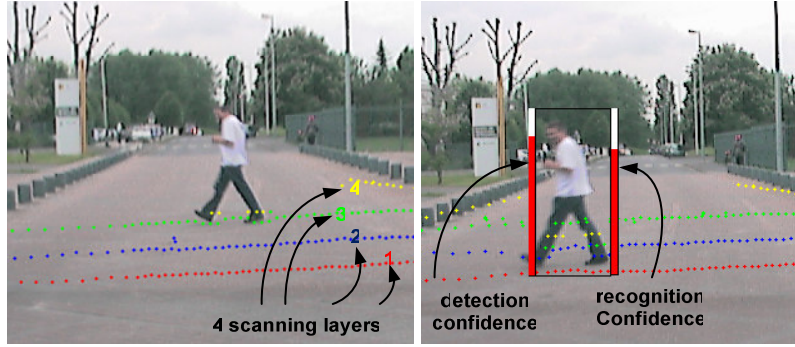

Fig.8. Projection on the image of the 4 scanning layers and the pedestrians with their corresponding detection and recognition confidences.

5.3. Experimental Results

Results show the efficiency of the described method in unsynchronized data fusion especially when the frequency of the incoming data is unknown or variable. As an example, we will show the detection and recognition confidence result of tracking one pedestrian detected by the laser scanner.

The probability of false alarm P_{FA} and false recognition P_{FR} of the first virtual Lidar are fixed respectively to 10% and 40%, while the second virtual Lidar has more false alarms with $P_{FA} = 40%$ and less false recognition with $P_{FR} = 10%$.

Fig.9 and Fig.10 show the results of tracking the same pedestrian during 90 Lidar scans. The 90 scans are distributed between the two virtual Lidar sensors. Fig.9 shows that the track detection confidence follows the confidence variation of the object detected by the first sensor having less false alarm probability than the

second sensor. While Fig.10 shows the variation of the tracked pedestrian's recognition confidence with the variation of the objects confidence detected by the two sensors.

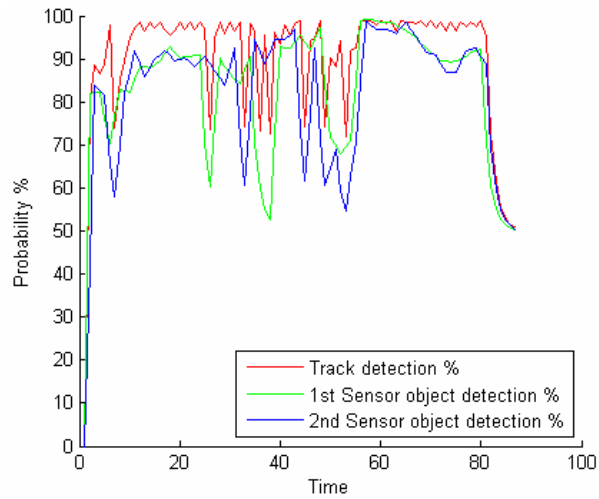

Fig.9. Track detection confidence variation of one pedestrian detected by two sensors having different detection performance.

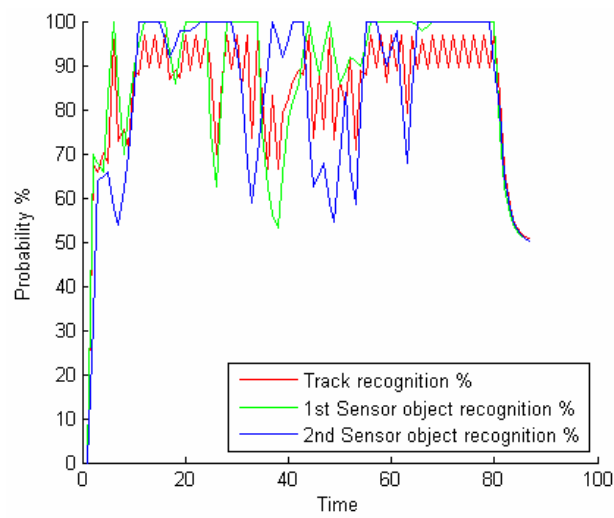

Fig.10. Track recognition confidence variation of one pedestrian recognized by two sensors having different recognition performance.

6. Conclusion and future works

In this paper we presented a multi-sensor fusion system dedicated to detect, recognize and track pedestrians. We differentiated between the two problems: object detection and pedestrian recognition, and quantified the confidence in the detection and recognition processes. The fusion by tracking method is used to solve the problem of asynchronous data provided by different sensors. The tracks state is divided into four parts and updated with different filters. Two of them are presented in this article: Kalman filter used for the kinematical state, and the detection and recognition confidences updated under the transferable belief framework. Results are shown with simulated and experimental data acquired in urban environment. Future works will concentrate on the validation of the method with multi-sensor data such as image and radar that have different performance in the detection and the recognition processes.

References

- [1] Sensors and system Architecture for Vulnerable road Users protection, <http://www.save-u.org/>
- [2] Integrated solutions for preventive and active safety systems, <http://www.prevent-ip.org/>
- [3] Cooperative vehicles and road infrastructure for road safety, <http://www.safespot-eu.org/>
- [4] Cherfaoui V., Denoeux T., Cherfi Z-L.: Distributed data fusion: application to the confidence management in vehicular networks. Proceedings of the 11th International Conference on Information Fusion, Cologne, Germany, Pages 846-853, July 2008
- [5] Fuerstenberg K.C., Lages U.: Pedestrian Detection and Classification by Laser scanners, 9th EAEC International Congress, Paris, France, June, 2003
- [6] Suard F. et al.: Pedestrian Detection using Stereo-vision and Graph Kernels. Proceedings of the IEEE Intelligent Vehicles Symposium IV'2005, Pages 267 – 272, June 2005
- [7] Viola P., Jones M. J. & Snow D.: Detecting pedestrians using patterns of motion and appearance. Proceedings of Ninth IEEE International Conference on the Computer Vision, Volume 63, Pages 153-161, Nice, France, October 2003
- [8] Tessier C. et al.: A Real-Time, Multi-Sensor Architecture for fusion of delayed observations: Application to Vehicle Localization. IEEE ITSC'2006, Toronto, Canada, September 2006
- [9] Sittler R.W.: An optimal data association problem in surveillance theory. IEEE transactions on military electronics, Volume 8, Issue 2, pages 125-139, April 1964
- [10] Fayad F. and Cherfaoui V.: Tracking objects using a laser scanner in driving situation based on modeling target shape, Proceedings of the IEEE Intelligent Vehicles Symposium IV'2007, Pages 44 - 49 Istanbul, Turkey June 2007
- [11] Bonnifait Ph. et al.: Dynamic Localization of Car-Like Vehicle using Data Fusion of Redundant ABS Sensors. The Journal of Navigation 2003, Volume 56, Pages 429-441
- [12] Julier S., Durrant-Whyte H.: Process Models for the High-Speed Navigation of Road Vehicles. Proceedings of the IEEE International Conference on Robotics and Automation, Volume 1, Pages 101-105, Nagoya, Japan, May 1995
- [13] Fayad F., Cherfaoui V., Dherbomez G.: Updating confidence indicators in a multi-sensor pedestrian tracking system, Proceedings of the IEEE Intelligent Vehicles Symposium IV'2008, Eindhoven, Holland, June 2008
- [14] Smets Ph., Kennes R.: The transferable belief model. Artificial Intelligence, Volume 66, Issue 2, Pages 191 – 234, April 1994
- [15] Denoeux T.: The cautious rule of combination for belief functions and some extensions. Proceedings of the Ninth International Conference on Information Fusion, Florence, Italy, Pages 1 – 8, July 2006
- [16] Denoeux T.: Conjunctive and Disjunctive Combination of Belief Functions Induced by Non Distinct Bodies of Evidence. Artificial Intelligence 2008, Vol. 172, Pages 234-264, February 2008
- [17] Elouedi Z. et al.: Assessing sensor reliability for multisensor data fusion within the transferable belief model, IEEE Transactions on Systems, Man and Cybernetics, Vol. 34, Page 782, February 2004
- [18] Sudano J.J.: Inverse pignistic probability transforms. Proceedings of the Fifth International Conference on Information Fusion, Volume 2, Issue 2002, Pages 763 - 768
- [19] Fayad F. and Cherfaoui V.: Detection and Recognition confidences update in a multi-sensor pedestrian tracking system. Proceedings of the twelfth international conference on Information Processing and Management of Uncertainty in knowledge-based systems IPMU2008, Malaga, Spain, June 2008