



**HAL**  
open science

## Mechanical behaviour of a fuel cell stack under vibrating conditions linked to aircraft applications part I: experimental

Vicky Rouss, Philippe Lesage, Sylvie Begot, Denis Candusso, Willy Charon, Fabien Harel, Xavier Francois, Viktor Selinger, Christine Schilo, Steen Yde-Andersen

### ► To cite this version:

Vicky Rouss, Philippe Lesage, Sylvie Begot, Denis Candusso, Willy Charon, et al.. Mechanical behaviour of a fuel cell stack under vibrating conditions linked to aircraft applications part I: experimental. *International Journal of Hydrogen Energy*, 2008, 33 (22), pp.6755-6765. 10.1016/j.ijhydene.2008.08.032 . hal-00441981

**HAL Id: hal-00441981**

**<https://hal.science/hal-00441981>**

Submitted on 27 Jun 2024

**HAL** is a multi-disciplinary open access archive for the deposit and dissemination of scientific research documents, whether they are published or not. The documents may come from teaching and research institutions in France or abroad, or from public or private research centers.

L'archive ouverte pluridisciplinaire **HAL**, est destinée au dépôt et à la diffusion de documents scientifiques de niveau recherche, publiés ou non, émanant des établissements d'enseignement et de recherche français ou étrangers, des laboratoires publics ou privés.

• V. Rouss, P. Lesage, S. Bégot, D. Candusso, W. Charon, F. Harel, X. François, V. Selinger, C. Schilo, S. Yde-Andersen (novembre 2008). *Mechanical behaviour of a fuel cell stack under vibrating solicitations linked to aircraft applications. Part I: Experimental*. Int. J. Hydrogen Energy. Vol. 33, n°22, pp. 6755-6765. Ed. Elsevier.

## **Mechanical behaviour of a fuel cell stack under vibrating conditions linked to aircraft applications Part I: Experimental**

Vicky Rouss <sup>a</sup>, Philippe Lesage <sup>a</sup>, Sylvie Bégot <sup>b</sup>, Denis Candusso <sup>c</sup>, Willy Charon <sup>a</sup>,  
Fabien Harel <sup>c</sup>, Xavier François <sup>b</sup>, Viktor Selinger <sup>d</sup>, Christine Schilo <sup>d</sup>, Steen Yde-  
Andersen <sup>e</sup>

<sup>a</sup> M3M, University of Technology Belfort - Montbéliard

<sup>b</sup> L2ES, University of Franche-Comté, University of Technology Belfort – Montbéliard

<sup>c</sup> INRETS, The French National Institute for Transport and Safety Research  
FCLAB, Rue Thierry Mieg, F 90010 BELFORT Cedex, FRANCE

<sup>d</sup> AIRBUS Deutschland GmbH, Systems Engineering  
Power Generation Development – EYVEC  
Kreetslag 10, DE 21129 HAMBURG, GERMANY

<sup>e</sup> IRD Fuel Cells A/S  
Kullinggade 31, 5700 SVENDBORG, DENMARK

### **Corresponding author:**

Tel: 0033 3 84 58 36 53

Fax: 0033 3 84 58 31 46

Email addresses: [vicky.rouss@utbm.fr](mailto:vicky.rouss@utbm.fr) (V. Rouss)

Other email addresses:

[willy.charon@utbm.fr](mailto:willy.charon@utbm.fr)

[philippe.lesage@utbm.fr](mailto:philippe.lesage@utbm.fr)

[sylvie.begot@univ-fcomte.fr](mailto:sylvie.begot@univ-fcomte.fr)

[denis.candusso@inrets.fr](mailto:denis.candusso@inrets.fr)

[fabien.harel@inrets.fr](mailto:fabien.harel@inrets.fr)

[xavier.francois@utbm.fr](mailto:xavier.francois@utbm.fr)

[viktor.selinger@airbus.com](mailto:viktor.selinger@airbus.com)

[christine.schilo@airbus.com](mailto:christine.schilo@airbus.com)

[sya@ird.dk](mailto:sya@ird.dk)

## **Abstract**

The implementation of fuel cells (FC) in transportation systems, as airplanes, requires some better understanding and mastering of their mechanical behaviours in vibrating environments. To this end, a FC stack is tested on a vibrating platform and characterised on the three geometric axes of the equipment. The impacts over the stack assembly of sine excitations with different frequencies and magnitudes are estimated using various accelerometers placed on different locations of the FC surface. Leak checks are also performed in order to verify that no malfunctions occur in the stack.

In this first part, some descriptions concerning the test facilities and the experimental setup are given, as well as some information about the mechanical test procedure applied. Some frequency – acceleration diagrams resulting from the experiments are shown and analysed. Finally, some assessments concerning the stack behaviour in vibrating conditions are made.

**Keywords:** PEM Fuel Cell; Vibration; Reliability; Complex mechanical system; Leak tests

## **1. Introduction**

Future aircraft designs will require some higher electrical energy due to an increased number of passengers and more sophisticated cabin environment for an improved comfort. Besides, while the electrical energy consumption will continue to grow, a reduction of fuel consumption, reduced noise and gaseous emissions will be expected to lower environmental impacts of airplanes. The application of FC systems on board of aircrafts can be considered as a promising option to achieve these requests and to propose some alternative to gas turbine based generators. Besides, as a drop in possibility, FC generators can also be considered for emergency power supply units [1]. So, if the FC system application can be a step towards the more electric airplane configuration, it has also the potential to achieve a technological breakthrough in the aircraft field. Indeed, the FC generator technology can provide high efficiencies. It has no nitrogen oxide exhaust and low carbon monoxide exhaust. Furthermore, the noise reduction in comparison with Auxiliary Power Unit (APU) can be significant. Although these features make the FC system a good candidate for power delivery, the current FC technology cannot meet all the requirements of aircraft applications. For instance, the power weight ratio and the starting time of a FC system have not reached the current APU values yet. Some additional works have thus to be conducted to improve these characteristics. Another essential task for the future is, beside the necessary cost reduction, the improvement of the reliability in particular with regard to the possible large mechanical loads encountered in aircrafts. Indeed, the flight conditions and the propulsion engines cause some vibrations on the airplane structure during its cruising. Some special impacts of vibrations can also be encountered during start and landing.

The FC stack can appear as inherently reliable due to its modular design and no (or few) moving parts. It can also be considered as a system with a quite complex mechanical structure in particular because it is composed of elements with strong dissimilar material structures. The FC stack is generally made of several single cells connected together, respectively in series and in parallel from the electrical and fluidic points of view. Each cell itself is a mechanical assembly of various components. It consists of two electrodes sandwiched around a proton-conducting polymer membrane, of gaskets on the perimeter of the Membrane Electrode Assemblies (MEAs) with Gas Diffusion

Layers (GDLs), and of bipolar plates. The gaskets have generally two sealing functions: overboard leak (i.e. gas escape from the stack inside to the external environment) and crossover leak (i.e. when some gas from cathode or anode crosses over through the membrane to the other side) [2]. All these entire stack elements are maintained together by tie rods, which role is to exert some proper uniform compaction pressures from surfaces of the end plates (current collection parts) to the complete stack. The torque value on the compression bolts, or pressure in a compression bladder or spring, conditions the tightness of the FC [3]. The torque applied has also an influence on the contact resistances between the various stack components, and thus on the FC electrical performances [4]. No excessive localised pressure shall be produced to prevent the formation of small perforations possibly caused by slight irregularities on the areas of the electrode – membrane interfaces, also to avoid that some MEA parts extrude into the flow fields of the distributive gas plates [5]. The pressure on the stack parts can also be impacted by the temperature variations within the stack in operation. Obviously, it can also be assumed that the torques on the tie rods are possibly modified by mechanical shocks or vibrations.

Subsequently, in order to implement FCs in transportation systems and in particular in airplanes, the mechanical behaviour of these new energy converters and the impacts of mechanical loads on their structures have to be accurately determined and well mastered. Therefore, experimental investigations under mechanical loads are necessary to acquire further knowledge of the FC stack behaviour and reliability under vibrating stress. The vibration tests shall notably demonstrate that the FC stack will survive different mechanical frequency and magnitude orders. The results of these mechanical characterisations can also be of major importance because so far only poor information on this specific topic is available in scientific publications. It is true that the interest on the mechanical aspects of FC stacks is currently on the rise. Engineers and researchers pay more and more attention to the mechanical responses and degradation mechanisms of the MEAs [6] under various operating conditions, such as humidity and temperature cycles [7, 8]. The mechanical characterisations of other FC stack components like GDLs and bipolar plates [9] are also of concern. The mechanical behaviour of the GDLs and the influence of these components on the FC performance have been investigated by different labs [10, 11]. The current development of composite and metallic bipolar plates requires conducting important mechanical studies as well [12, 13]. Nevertheless, just a few works dealing precisely with the mechanical impact of vibrations on FC stacks are briefly reported in the literature. In [3], M. Fowler et al. claim that PEM fuel cell stacks have passed shock and vibrating testing. Two references dealing with FC for naval surface ship applications are mentioned [14, 15]. Seals are considered as a potential source of failure, which can induce significant leaking of hydrogen, or mixing of hydrogen and oxygen within the stack. It is recognized that the sealing and the gaskets are prone to material degradation [2, 16] even when no particular vibrating conditions are imposed to the FC (note that in this case some mechanical stresses are though induced by some pressure gaps between the anode and the cathode compartments). Therefore, beside the thin membranes (membrane thickness is usually ranging between 25 and 150 $\mu$ m) they may constitute some weak points within the FC stack assembly subjected to vibrations or shocks.

In the framework of the European project CELINA (fuel cell application in a new configured aircraft [1, 17]), the mechanical characterisation of a PEM fuel cell has been launched. Some vibration tests have been performed with a five cell stack manufactured

by IRD [18] and the mechanical loads applied to the stack were derived from airplane requirements. The effects of the vibrations had to be investigated to define the suitability of a today's Proton Exchange Membrane (PEM) FC assembly.

The article is organised as follows. The paper starts with the description of the test bench and the test procedure. Then, some test results of the FC mechanical characterisation are presented and discussed. Finally, some assessments concerning the stack behaviour in vibrating conditions are made, and some outlooks are proposed for future experimental studies. Note that the experiment data will also serve for modelling purpose in the part II of the paper.

## 2. The test bench

The test bench is composed of the vibrating platform, the experimental setup, the data acquisition systems and the leak rate monitoring.

### 2.1. Vibrating platform

The vibrating equipment is composed of two different tables: one for the horizontal excitations and the other one for the vertical excitations (see Fig. 1). The first table vibrates in the X direction, the second one in the Z axis direction. The 90° rotation of the studied system on the surface of the horizontal table allows the test in the Y direction. The shaker can be rotated either to displace the table for horizontal vibrations, or to move the second table in the Z direction. The vibrating equipment has the following properties. The frequency sweeping ranges from 6 to 3000 Hz, the maximum displacement of the vibrating table (peak to peak) equals 50 mm, the maximum velocity is 1.8 m/s, and the maximum force is 35.6 kN. Using specific software, it is possible to control excitations as swept sine, shocks and random vibrations.

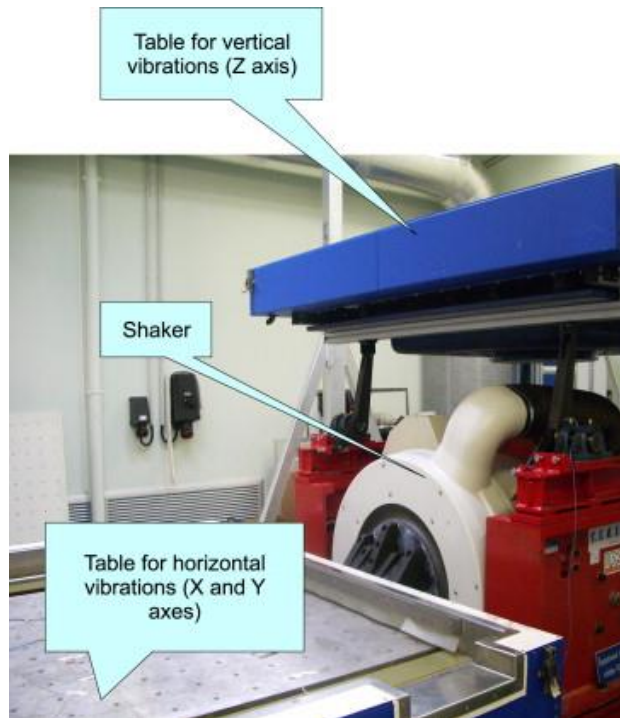

Fig. 1 - The vibrating platform.

## 2.2. Experimental setup

The investigations were led with an existing (low temperature) PEMFC stack delivered by IRD [18]. The five cell stack has been assembled with commercially available membranes (active cell area of 156cm<sup>2</sup>), GDLs and machined graphite flow distribution plates. The FC can operate either at atmospheric pressure or at higher pressure (up to 3bar abs. approximately).

In the experiments, the FC stack is considered as a mechanical system to be studied and the aim is to collect some data related with its nonlinear mechanical behaviour. The FC is maintained on the vibrating table by using some specific fixations, which were designed accordingly to the size of the FC. The test fixture shall be as rigid and symmetrical as possible.

The vibrating movement is parallel to one of the three orthogonal axes. The set of photos displayed in Fig. 2 shows the set-up configuration used for the tests in the Y direction (table for horizontal vibrations). Various accelerometers were used to perform the measurements: one dimensional (1D) and three dimensional (3D) sensors. The control accelerometer is placed directly on the surface of the vibrating table while the other 1D and 3D accelerometers are distributed on the investigated FC stack: on the top surface of the FC end plate (3D), on the top surface of the sole plate (3D), on the top surface of the mid position bipolar plate (3D), on the top surface of the mid position bipolar plate left side (1D) and right side (1D). The location of the various accelerometers can be observed in Fig. 2. The properties of all accelerometers are shown in Fig. 3.

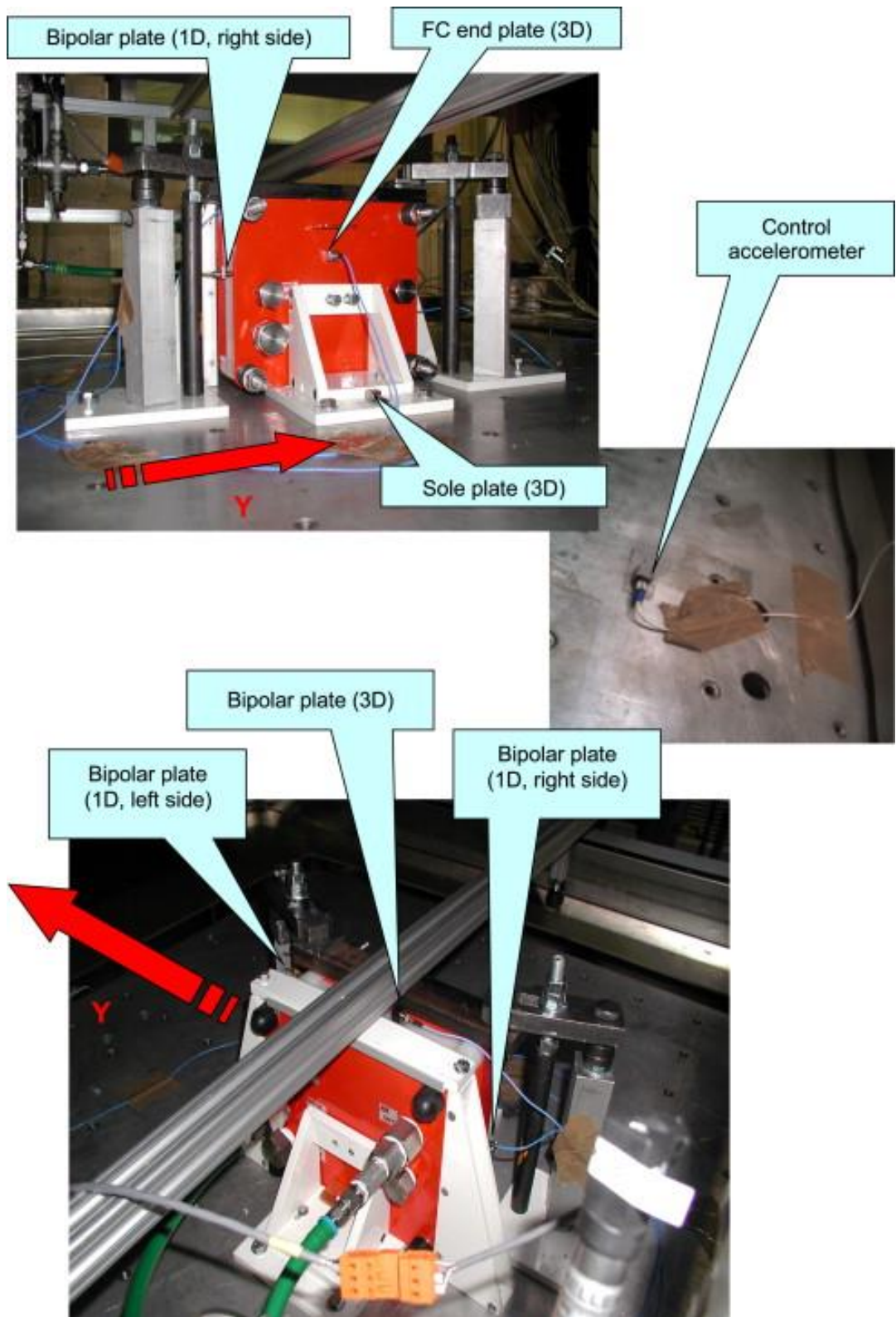

Fig. 2 - Location of the accelerometers on the FC (tests in Y axis - table for horizontal vibrations).

Type	Name	Direction	Measured quantity	Sensitivity [mV/g]	Transducer type
Measure	Sole plate 3D	+X	Acceleration	9,42	PCB-HT356B21
Measure	Sole plate 3D	+Y	Acceleration	10,22	PCB-HT356B21
Measure	Sole plate 3D	+Z	Acceleration	9,77	PCB-HT356B21
Measure	Bipolar plate 1D, left side	+Y	Acceleration	10,06	PCB-M320C16
Measure	Bipolar plate 1D, right side	-Y	Acceleration	10,06	PCB-M320C16
Measure	Bipolar plate 3D	+X	Acceleration	10,05	PCB-HT356B21
Measure	Bipolar plate 3D	+Y	Acceleration	9,85	PCB-HT356B21
Measure	Bipolar plate 3D	+Z	Acceleration	9,69	PCB-HT356B21
Measure	FC end plate 3D	+X	Acceleration	10,16	PCB-HT356B21
Measure	FC end plate 3D	+Y	Acceleration	9,61	PCB-HT356B21
Measure	FC end plate 3D	+Z	Acceleration	10,06	PCB-HT356B21
Control	Vibrating table	+X	Acceleration	98,9	B&K-4507

Fig. 3 - Characteristics of the accelerometers.

### 2.3. Data acquisition systems

The installation is equipped with two acquisition systems. The first one, LMS acquisition system, gives processed data as signals spectra for example. The second one, with a USB interface, allows access to raw data and collects the pressure and flow signals. In fact, the frequency bandwidth for the swept sine tests varies from 6 to 2000 Hz. If data were collected at a constant sample rate, its value should be around 20000 Hz and a too large data vector would be obtained for the modelling tasks with an increase of the training set dimension and eventually the model estimation time. To solve this problem, a special acquisition program allowing the collection of data with a variable sampling frequency in real time was developed. This permits to cover all the frequency bandwidth with a reasonable number of points.

All the experiment data can be exploited for test analysis and modelling purpose using a dedicated Matlab<sup>TM</sup> [19] program.



## 2.4. Leak rate monitoring

Another objective of the tests is to know if the mechanical vibrations can lead to damages in the FC like breaks (or cracks) in MEAs, in gaskets or defective sealings due to the displacements of components. To reach this aim, a flow meter and three pressure sensors were added to the set-up to perform leak checks (simultaneously to the tests). Only the anode compartment is pressurised with nitrogen at about 300 mbar rel (through the manual control of an expander) while the other compartments (cathode and cooling) are sealed off at ambient pressure. The pressure levels in each one of the compartments are monitored in order to detect any possible internal leakage flow between the compartments. In addition, a flow meter is used to monitor the potential nitrogen flow coming towards the anode compartment (due to the pressure regulation). With the adopted test configuration, this flow meter provides some information about a possible internal leakage as well as some indications concerning a possible external leakage flow (i.e. from the compartments to the outside of the stack). The collection of the pressure and flow signals is made through the second acquisition system. The gas leakage station is also equipped with two numerical displays: for the nitrogen pressure and flow. A sketch of the set-up used to monitor the leakage flow and the pressures inside the three different FC compartments is displayed in Fig. 4. Some technical information related with the flow and pressure sensors is given in Fig. 5.

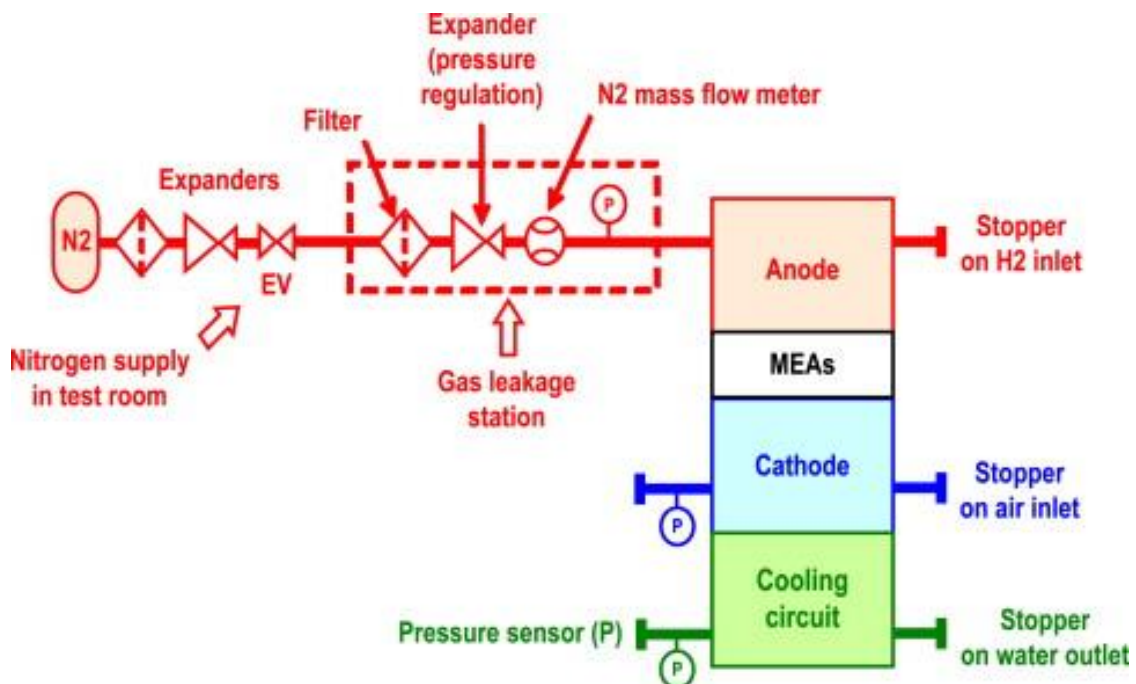

Fig. 4 - Fluidic scheme of the set-up used to monitor the compartments pressures and the nitrogen leakage flow versus time.

Sensor	Range	Accuracy	Comments
Leakage flow-meter in gas leakage station	0 – 40 NI/min	±0.7% of the flow value	Brooks flow-meter
Pressure transducer on anode	0 – 10 bar rel.	± 0.25% of full scale	Keller piezoresistive transmitters
Pressure transducer on cathode	0 – 6 bar rel.	± 0.25% of full scale	Keller piezoresistive transmitters
Pressure transducer on cooling circuit	0 – 6 bar rel.	± 0.25% of full scale	Keller piezoresistive transmitters

Fig. 5 - Technical information about the pressure and flow sensors available for the experiments.

### 3. Test procedure

The system is excited in the three axes directions separately. Therefore, there are three data collections that enable to investigate the system mechanical behaviour in each one of the three directions of excitations.

The FC integrated into the tail cone is categorized in DO-160D as Equipment category R (robust vibration) [20]. A specific test reference curve for the sinusoidal test excitations (acceleration amplitude vs. frequency) is provided by Airbus.

On each axis, the experimental procedure is the same and it is composed of different tests. Each test corresponds to constant acceleration amplitude and variable frequency from  $f_1$  to  $f_2$ . It contains two sweeps; the first sweep goes from  $f_1$  to  $f_2$  and the second sweep from  $f_2$  to  $f_1$ .  $f_1$  equals 6Hz and  $f_2$  is different for each test. The value of  $f_2$  is calculated from the amplitude of acceleration (g) (different for each test) and the amplitude of peak-to-peak displacement (constant for all tests, equals 0.0001 inch or 0.00254mm).

For example, the first test corresponds to acceleration amplitude of 1g; the first sweep starts with a frequency of 6 Hz and amplitude of displacement (peak to peak) of 0.1 inch (2.54 mm). It ends with a frequency of 442 Hz and amplitude of displacement (peak to peak) of 0.0001 inch (0.00254 mm). The second sweep starts with the frequency of 442 Hz (0.0001 inch) and ends with the frequency of 6 Hz (0.1 inch). Then, the acceleration magnitude is gradually increased by step of 1 g for each test. The novel test procedure is detailed in Fig.6.

Acceleration (g)	Starting frequency (Hz)	Starting displacement peak to peak (mm)	Ending frequency (Hz)	Ending displacement peak to peak (mm)
1	6	2.54	442	0.00254
2	6	2.54	625	0.00254
3	6	2.54	776	0.00254
4	6	2.54	884	0.00254
5	6	2.54	988	0.00254
6	6	2.54	1083	0.00254
7	6	2.54	1170	0.00254
8	6	2.54	1250	0.00254
9	6	2.54	1326	0.00254
10	6	2.54	1398	0.00254
11	6	2.54	1466	0.00254
12	6	2.54	1532	0.00254
13	6	2.54	1596	0.00254
14	6	2.54	1657	0.00254
15	6	2.54	1715	0.00254
16	6	2.54	1771	0.00254
17	6	2.54	1825	0.00254
18	6	2.54	1878	0.00254
19	6	2.54	1930	0.00254
20	6	2.54	2000	0.00254

Fig. 6 - The test procedure details (sweep 1 for each test).

For each new acceleration level and before the complete vibration cycle is applied, a short preliminary test is performed by using a sample of random excitations. The aim is mainly to verify that the fixations will not move during the achievement of the next complete profile.

Each test related to a specific acceleration profile takes between 10 and 30 minutes. The test duration depends on the frequency bandwidth as well as on the adopted logarithmic sweep rate (1 octave/minute). For example, for the 12 g profile, the theoretical duration of a single sweep (i.e. realised by increasing the frequency) is equal to 8'15". The total

test duration is 16'30" since two sweeps have to be considered: by increasing and by decreasing the frequency. Obviously, some additional time is needed between the two tests in order to check that the FC and its fixations have not moved.

For the natural frequencies (specially the natural frequencies of the vibrating table), which have some high impacts on the acceleration amplitudes measured by the sensors, the vibrating table and its control system cannot be operated. Indeed, a safety procedure included in the control software avoids too large amplitude of the accelerometer measurements by switching off the shaker operation.

Due to this effect of the natural frequencies of the table, some frequency intervals especially at high frequencies could not be explored. Consequently the related experiments had to be performed in several times / parts: the complete frequency range had to be decomposed in several sub frequency ranges / intervals and the tests took more time.

#### **4. Test results**

In this section, some test results and acceleration – frequency diagrams are presented in the case of the Y axis tests as an example. Then, some general comments are made concerning all the three orthogonal axes. Some information about the results of the leak rate monitoring is also provided.

##### **4.1. Example of the excitation in the Y axis direction**

The experiments for the Y axis could be performed for acceleration levels ranging from 1 g to 9 g. As mentioned in the previous section, the high acceleration levels (here, beyond 9 g) led to excessive splitting up of the test profile achievement. Because of the natural frequency of the table in the horizontal position, the profile could not be realised around 700 Hz. For X and Z axes, the experiments could be performed until 9 g and 12 g respectively.

Figs 7, 8 and 9 show the spectra of the sole plate accelerometer (3D), the 3 bipolar plate accelerometers (one (3D) and two (1D)) and the FC end plate accelerometer (3D) measurements for an acceleration of 5 g.

The natural frequency of the table that occurs around 700 Hz can easily be observed in Fig. 7. Indeed, the sensor on the sole plate is more sensitive to the natural frequencies of the table since it is screwed on the vibrating table. Note that the natural frequencies of the table are also measured by the sensors located on the stack (for instance, see Fig. 8 and 9 at 700 Hz).

Each part of the FC shows different dynamical responses. This shows that the stack does not behave like a rigid body but instead shows an elastic behaviour due to

- the mechanical properties of the FC sub components (component materials, rigidities),
- the constraints due to different clamping values related with the FC tie rods,
- the different sensor locations in the X, Y and Z referential.

Therefore, some natural frequencies of the bipolar plate and the FC end plate are not the same. These frequencies, which were measured by the accelerometers on the bipolar plate and on the FC end plate, are summarised in Fig. 10. The natural frequencies of the table shall be extracted because they are not due to the stack itself.

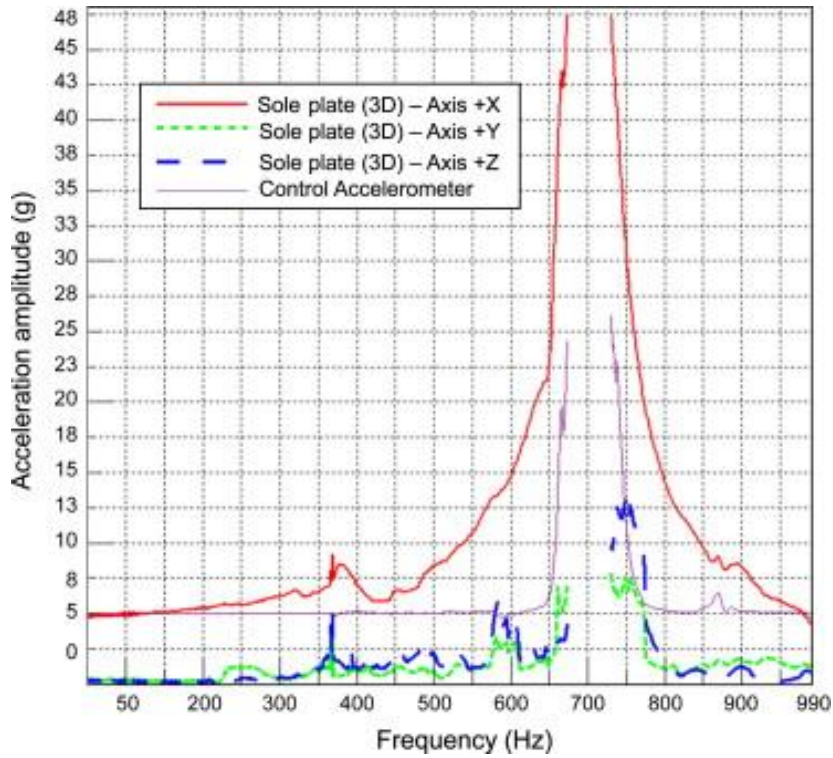

Fig. 7 - Spectra of the sole plate accelerometer (3D) measurements for Y axis tests (acceleration of 5g).

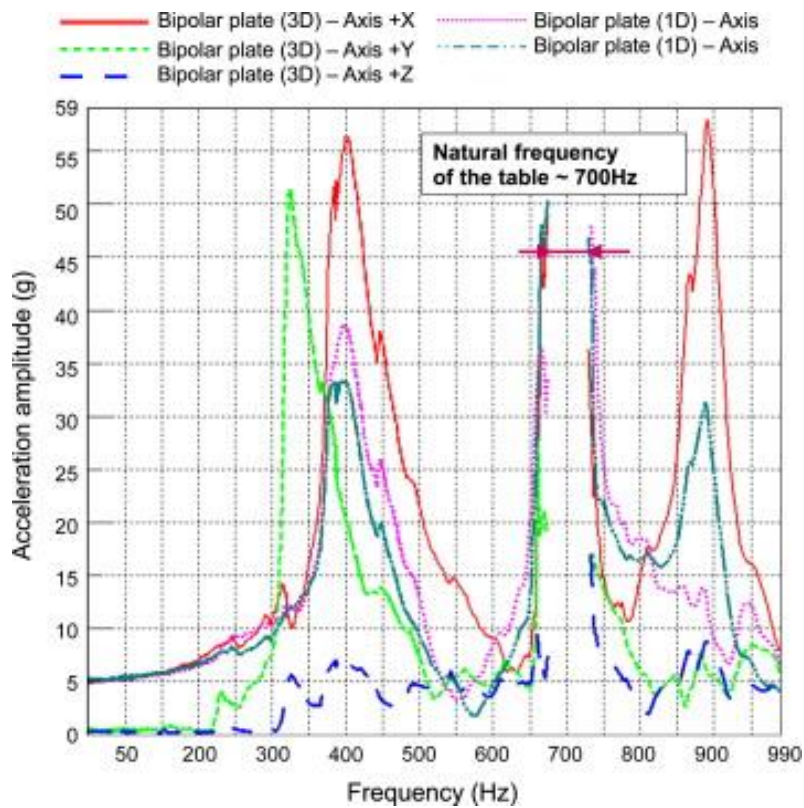

Fig. 8 - Spectra of the 3 bipolar plate accelerometers measurements for Y axis tests (acceleration of 5g).

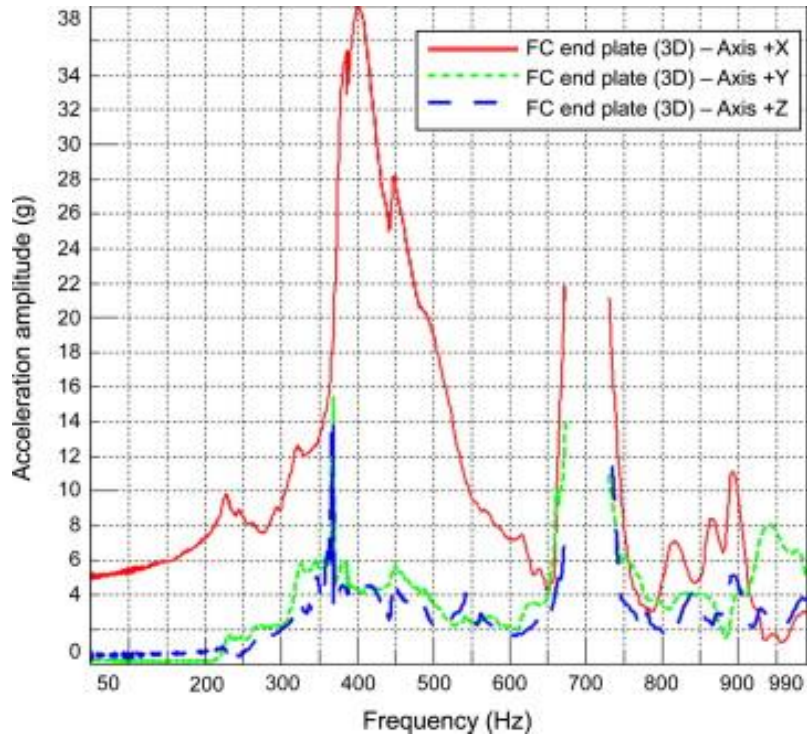

Fig. 9 - Spectra of the FC end plate accelerometer (3D) measurements for Y axis tests (acceleration of 5g).

FC end plate			Bipolar plate				
3D			3D			1D	1D
+X (red)	+Y (green)	+Z (blue)	+X (red)	+Y (green)	+Z (blue)	-Y (purple)	+Y (green-blue)
				230		230	230
	330			330	330		
Table	400	370	370	400		400	400
	450	450	450	450		450	450
		540		560			
				620			
Table	700	700	700	700	700	700	700
	820		840	830			820
	870				870		
	890	890	890	890		890	890
		940	930		990		950
		1030					1040
	1120	1120	1150	1120		1125	1120
	1200	1220	1200	1200			1160
	1260	1260	1260	1260	1260	1260	1200
	1360	1390	1360	1360	1340		1250
	1410	1420	1410	1400	1380	1420	
				1430			1410

Fig. 10 - Resonance frequencies (Hz) measured by the accelerometers on the bipolar plate and the FC end plate for Y axis tests.

Another important remark is that vibrating the FC in the Y direction causes resonance frequencies in all directions but especially in the X direction. The measurements in X and Y directions show a high correlation.

An example of this correlation is the dynamical response of the bipolar plate around 890 Hz. A common natural frequency is measured by the (+X) direction of the 3D

accelerometer, the (+Y) and the (-Y) directions of the two (1D) accelerometers on the left and right sides of the bipolar plate. But this frequency is not measured by the (+Y) direction of the (3D) accelerometers which are located on the centre and top of the bipolar plate. A possible explanation is that for this resonance frequency, some movements of rotations of the bipolar plate can probably occur.

An analysis of the temporal signals measured by the three bipolar plate accelerometers at this frequency demonstrates that the two lateral sides of the bipolar plate move in the same direction. But it shows also that the amplitude of the acceleration measured by the left side accelerometer is around three times larger than for the right side. For example, if the excitation is in the (+Y) direction (black lines in Fig. 11), the two (1D) accelerometers measure some accelerations in the (+Y) direction and the (3D) accelerometer measures some accelerations in the (-X), (-Y) and (-Z) directions. Note that the amplitude of the acceleration measured in the (-X) direction is around six times larger than in the (-Y) and (-Z) directions. If the excitation is in the (-Y) direction, the accelerations measured have an opposite sign. Note that no information is available about the displacement of the lowest horizontal side of the bipolar plate since no accelerometer was attached there during the experiments.

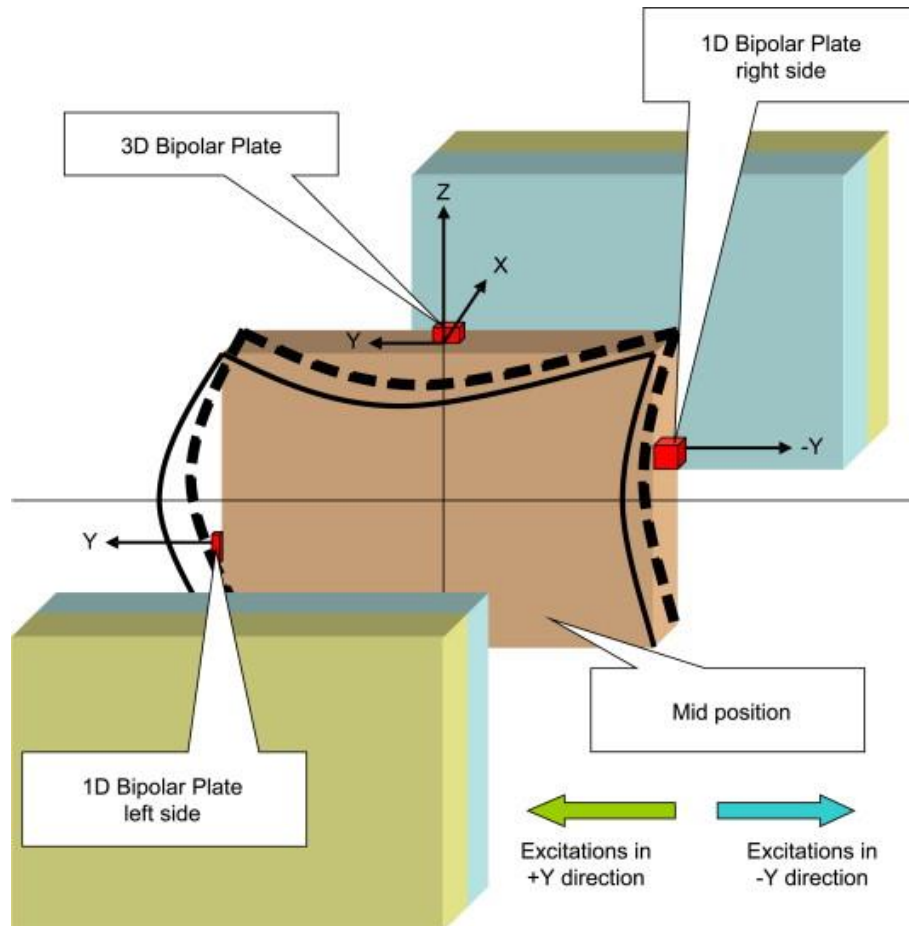

Fig. 11 - The analysis of the temporal signals of the bipolar plate accelerometers

#### 4.2. Observations concerning the three directions

The observations made in the Y axis are the same in the other axes (X and Z axes):

- Vibrating the system on the Y axis for example causes natural frequencies not only on the Y axis but also on the other axes (and vice versa). The responses in the three directions are correlated.
- The frequencies measured on the bipolar plate and at the FC end plate are slightly different, especially at high frequencies. The explanation proposed is that the stack assembly is composed of several sub-systems. At high frequencies, the natural frequencies of these sub-systems are exceeded. Therefore, the resonance responses of these sub-systems are coupled and the final response depends on the place where the measurement is done.

Each sensor attached to a different part of the FC can show similar or different dynamical responses:

- Similar: some global vibration modes exist. If a vibration is not measured with a specified sensor, it may be due to a node at this location.
- Different: some local modes exist, generally with few vibrating mass or in a fully different frequency domain as the global modes.

It is not possible at this stage to fully distinguish between local and global vibration modes. Only comparison between numerical model and test results could help. Therefore, a deeper analysis involving a neural network model of the FC is developed in the second part of this paper.

#### 4.3. Leak rate tests

Some comments can be made about the evolution of the pressures inside the three compartments during the vibration tests when the FC anode was pressurised. The main point and conclusion of the leak rate tests is that no detectable and significant leakage from the anode manifold was measured during testing. No increase of pressure due to any break in membrane or displaced sealing was detected at cathode side: the cathode remained at ambient pressure. The pressure value indicated by the transmitter linked to the cooling compartment was also constant during the series of tests (ambient pressure). A slight decrease of the pressure at anode side was detected: an average pressure loss rate of approximately 25mbar / hour was estimated during the tests. This value corresponds actually to measurements performed during the phases in which no mechanical vibrations were applied on the FC. This low leakage rate is likely to be explained by possible external leakages, from the anode compartment to the outside of the stack, and mainly situated at the fluidic stack connections / fittings. A small lack of tightness was possibly encountered at these locations due to the necessary use of Teflon between the different surfaces of the gas fittings. However, no large and sudden drop-down of the pressure caused by any FC component break or displacement was detected and no rapid increase of the pressures in the other compartment could be observed. In addition, the leakage flow signal was measured by the flow-meter placed upstream of the anode compartment. As mentioned in subsection 2.4., this flow-meter gives some information concerning the nitrogen flow coming towards the anode side (see Fig. 4.). No large / significant signal deviation like a flow value superior to 1Nl/min was detected. Such a value would then correspond to a clean / sever component break inside the FC. Note that other pressure and flow sensors having some more restricted operating ranges and higher accuracies shall be used in future tests, possibly in order to enable the detection of any minor loss of tightness in the stack operated under vibrating constraints.



Another technological issue related with the integrity of the FC stack under vibrating conditions concerns the gas and water fittings. The fittings used during these experiments and made of stainless steel were found as quite long and heavy. As already mentioned, no particular problem occurred with the stack in the conducted experiments. However, it should be stated that the adopted gas and water connections could have damaged the stack inlets during the vibration tests, especially at the locations where the stack inlet and outlet pipes meet the end plate surfaces, and because of possible harmful torques or unbalances. The lengths and the positions of the gas pipes (“push on” pipes) as a function of the pressure sensor locations on their support frame were selected in order to reduce the constraints exerted by the pipes on the inlet and outlet connecting parts. The use of alternating fittings, a new design of end plates and fluidic connections could also probably reduce the risks of getting some broken component parts and fluid leakages.

## **5. Conclusion and outlook**

The integration of a FC system into an aircraft is a complex and challenging task. Indeed, the state-of-the-art PEMFC technology, which is still under development, has to be adapted to extreme ambient operating conditions and designed for extremely high dynamic requirements while warranting maximum availability and reliability. In particular, the behaviour of FCs subjected to different mechanical loads has to be studied and to reach this aim, proper and innovative test procedures have to be developed.

In this work, a mechanical characterisation of a PEM fuel cell stack was done and the natural frequencies of the assembly were measured. The analysis of the temporal signals measured with 1D and 3D accelerometers and the corresponding spectra leads to the following conclusions. First, the stack exhibits 3D nonlinear, multi-body behaviour. Second, the investigated stack does not mechanically fail under the aviation-specific vibration tests. No significant variation of the leakage rate between the beginning and the end of the test series was observed and thus, no problem of membrane cracks or other malfunctions in the stack (e.g. defective sealing) could be observed.

Since the results concern a short FC assembly only, the results related with the test of a stack composed of a higher number of cells are likely to be different. For instance, the rigidity of such an assembly is for sure not the same. A greater mechanical flexibility of the stack could cause vibrations decreasing from time to time the contact forces between two cells and therefore lead to some gas leakage.

The conclusions concerning the results on the mechanical behaviour of stacks with different sizes and cell numbers could be helpful especially to determine if the association of short / medium stacks is preferable, in terms of mechanical reliability, to the use of a single large stack in order to deliver high power levels. If redundancy is achieved by this way into the system, the reliability of the complete generator might be increased dramatically. To reach this aim, some electrical coupling of stack in series could be ensured by the means of dedicated electronic interfaces [21].

The mechanical design of the full stack is not the same as the design of the short tested stack e.g. concerning the fluid inlets. That could change the behaviour due to dynamic mechanical excitations. The analysis of such behaviour could lead to recommendations concerning the overall mechanical design.

The lifetime problem is another compulsory task for the use of FC systems in future airplanes. Indeed, the impact of vibrations on FC stacks should be studied also over long time periods. Obviously, the mechanical behaviour and electrical performances of FCs operated under vibrating conditions and supplied with reactive gases should be determined as well.

In any case, in order to optimally pilot and control the vibrating tests, some highly efficient models with fine performances in static and dynamic operational conditions will be required.

### **Acknowledgments**

This work was done in the framework of the CELINA project. The EU is gratefully acknowledged for its financial support.

### **References**

- [1] Schilo C. Fuel Cell Application In A New Configured Aircraft. In: 1st CEAS European Air and Space Conference, Berlin, Germany, 2007.
- [2] Husar A, Serra M, Kunusch C. Description of gasket failure in a 7 cell PEMFC stack. *Journal of Power Sources* 2007;169:85-91.
- [3] Fowler M, Mann RF, Amphlett JC, Peppley BA, Roberge PR. Reliability issues and voltage degradation. In: Vielstich W, Gasteiger HA, Lamm A, editors. *Handbook of fuel cells - fundamentals technology and applications, Fuel cell technology and applications*, Wiley & Sons, Inc, New York, 2003. p. 663–677.
- [4] Lee W, Chien-Hsien H, Van Zee J, Murthy M. The effects of compression and gas diffusion layers on the performance of a PEM fuel cell. *Journal of Power Sources* 1999; 84:45-51.
- [5] Laconti AB, Hamdan M, Mc Donald RC. Mechanisms of membrane degradation. In: Vielstich W, Gasteiger HA, Lamm A, editors. *Handbook of fuel cells - fundamentals technology and applications, Fuel cell technology and applications*, Wiley & Sons, Inc. New York, 2003. p. 647–662.
- [6] Collier A, Wang H, Zi Yuan X, Zhang J, Wilkinson DP. Degradation of polymer electrolyte membranes. *International Journal of Hydrogen Energy* 2006;31:1838-1854.
- [7] Kusoglu A, Karlsson AM, Santare MH, Cleghorn S, Johnson WB. Mechanical behavior of fuel cell membranes under humidity cycles and effect of swelling anisotropy on the fatigue stresses. *Journal of Power Sources* 2007;170:345-358.
- [8] Solasi R, Zou Y, Reifsnider K, Huang X, Condit D. On mechanical behavior and in-plane modeling of constrained PEM fuel cell membranes subjected to hydration and temperature cycles. *Journal of Power Sources* 2007;167:366-377.
- [9] Li X, Sabir I. Review of bipolar plates in PEM fuel cells: Flow-field designs. *International Journal of Hydrogen Energy* 2005;30:359-371.
- [10] Escribano S, Blachot JF, Ethève J, Morin A, Mosdale R. Characterization of PEMFCs gas diffusion layers properties. *Journal of Power Sources* 2006;156:8-13.
- [11] Nitta I, Hottinen T, Himanena O, Mikkola M. Inhomogeneous compression of PEMFC gas diffusion layer, Part I. Experimental. *Journal of Power Sources* 2007;171:26-36.

- [12] Cho EA, Jeon US, Hong SA, Oh IH, Kang SG. Performance of a 1kW-class PEMFC stack using TiN-coated 316 stainless steel bipolar plates. *Journal of Power Sources* 2004;142:177-183.
- [13] Heinzl A, Mahlendorf F, Niemzig O, Kreuz C. Injection moulded low cost bipolar plates for PEM fuel cells. *Journal of Power Sources* 2004;131:35-40.
- [14] Privette RM. PEM Fuel Cell Evaluation for Navy Surface Ship Applications. In: 34<sup>th</sup> Intersociety Energy Conversion Engineering Conference, Vancouver, Canada, 1999.
- [15] Schmal D, Kluiters CE. Development of a Polymer Fuel Cell System for Naval Surface Ship Applications. In: Fuel Cell Seminar, Palm Springs, FL., USA, 1998.
- [16] Tan J, Chao YJ, Van Zee JW, Lee WK. Degradation of elastomeric gasket materials in PEM fuel cells. *Materials Science and Engineering: A* 2007;445-446:669-675.
- [17] CELINA, Fuel Cell Application in a New Configured Aircraft, web site, [http://ec.europa.eu/research/transport/projects/article\\_3684\\_en.html](http://ec.europa.eu/research/transport/projects/article_3684_en.html).
- [18] IRD Fuel Cell Technology web site, <http://www.ird.dk/>.
- [19] MATLAB<sup>TM</sup> Software, The MathWorks, Inc., <http://www.mathworks.com>.
- [20] Document RTCA/DO-160E. Environmental Conditions and Test Procedures for Airborne Equipment. International standard for environmental testing of commercial avionics, 2004.
- [21] Candusso D, De Bernardinis A, Péra MC, Harel F, François X, Hissel D, Coquery G, Kauffmann JM. Fuel cell operation under degraded working modes and study of diode by-pass circuit dedicated to multi-stack association. *Energy Conversion and Management* 2008;49:880-895.

## Nomenclature

### Alphabets

<i>DO-160D</i>	Environmental conditions and test procedures for airborne equipment
<i>FC</i>	Fuel Cell
<i>APU</i>	Auxiliary Power Unit
<i>MEA</i>	Membrane Electrode Assemblies
<i>GDL</i>	Gas Diffusion Layers
<i>PEM</i>	Proton Exchange Membrane
<i>CELINA</i>	Fuel Cell Application in a New Configured Aircraft
<i>3D</i>	Three dimensional accelerometers
<i>1D</i>	One dimensional accelerometers
<i>USB</i>	Universal Serial Bus

### Units

<i>bar abs</i>	Indicates bars <i>absolute</i> , measuring the total pressure including the pressure of the atmosphere (101.325 kPa).
<i>bar rel</i>	Bar rel indicates bars <i>relative</i> , measuring the difference between the pressure of the fluid or gas and the pressure of the atmosphere.
<i>Nl</i>	A unit of mass for gases equal to the mass of 1 liter at a pressure of 1 atmosphere (101.325 kPa) and at a standard temperature, often 0 °C. Air flow is often stated in normal liters per minute (Nl/min).