



HAL
open science

Using the CORDIS-ANIMA Formalism for the Physical Modeling of the Greek Zournas Shawn

Alexandros Kontogeorgakopoulos, Panagiotis Tzevelekos, Claude Cadoz,
Georgios Kouroupetroglou

► **To cite this version:**

Alexandros Kontogeorgakopoulos, Panagiotis Tzevelekos, Claude Cadoz, Georgios Kouroupetroglou. Using the CORDIS-ANIMA Formalism for the Physical Modeling of the Greek Zournas Shawn. International Computer Music Conference 2008, Aug 2008, Belfast, Ireland. pp.395-398. hal-00437867

HAL Id: hal-00437867

<https://hal.science/hal-00437867>

Submitted on 1 Dec 2009

HAL is a multi-disciplinary open access archive for the deposit and dissemination of scientific research documents, whether they are published or not. The documents may come from teaching and research institutions in France or abroad, or from public or private research centers.

L'archive ouverte pluridisciplinaire **HAL**, est destinée au dépôt et à la diffusion de documents scientifiques de niveau recherche, publiés ou non, émanant des établissements d'enseignement et de recherche français ou étrangers, des laboratoires publics ou privés.

USING THE CORDIS-ANIMA FORMALISM FOR THE PHYSICAL MODELING OF THE GREEK *ZOURNAS* SHAWM

Alexandros Kontogeorgakopoulos
ACROE-ICA laboratory
INPG, Grenoble, France
Alexandros.Kontogeorga
kopoulos@imag.fr

Panagiotis Tzevelekos
National Kapodistrian
University of Athens,
Department of
Informatics and
Telecommunications,
Athens, Greece
taktzev@di.uoa.gr

Claude Cadoz
ACROE-ICA
laboratory INPG,
Grenoble, France
Claude.Cadoz@im
ag.fr

Georgios Kouroupetroglou
National Kapodistrian
University of Athens,
Department of
Informatics and
Telecommunications,
Athens, Greece
koupe@di.uoa.gr

ABSTRACT

We propose a numerical simulation for the physical model of the *zournas*, a Greek traditional double-reed woodwind musical instrument, following the mass-interaction CORDIS-ANIMA formalism. The functional components of the instrument are implemented using original CORDIS-ANIMA modules, while special attention has been given to the flow characteristics of the reed.

1. INTRODUCTION

Physical modeling is not a new concept in the area of digital sound synthesis. However, the great possibilities that allows in terms acoustical procedure representation and control of the designed model, makes it one of the most intriguing for both acoustics researchers and musicians.

Many methodologies have been proposed, each one corresponding to a different formalism philosophy and different applications. CORDIS-ANIMA (CA) is one of the oldest, but still finds many followers. New modules are designed, more instruments are implemented and various composers write music using CA and GENESIS environment.

During the last decades, there has been an increased interest in the study of traditional musical instruments. While musicians “go back to the roots” and rediscover instruments of the old, researchers design experiments to measure their acoustical properties. As our knowledge in the science of traditional instruments increases, so does the desire to design their physical models.

In this paper, we present a first approach on the physical model of the *zournas*, the Greek shawm, based on the CA scheme. We begin by pointing some musicological and organological information on the *zournas*. After listing some of the instrument’s physical parameters, we proceed with the description of the model. The bore and the reed are represented by a novel CA module, and then linked together. Possible hysteresis in the flow-pressure characteristic of the reed is taken into account.

2. THE *ZOURNAS*

The *zournas* is a traditional Greek double-reed woodwind instrument. It resembles the medieval shawm and is widely spread throughout Europe, Northern Africa, Asia Minor, Middle East, India and China. It is considered to be the ancestor of the modern oboe.

As in most woodwind instruments, the embouchure and the bore are the major parts of the instrument. The double reed, called “tsampouni” is tied upon a conical metal tube, called “caneli”. They both shape the embouchure which is inserted in the bore, through a wooden part, called “kleftis”. The bore is conical, there are no mechanical keys and the number of toneholes is usually seven. The bore ends up to a bell with a flare, most of the times bigger than the one of the clarinet or the oboe.

In Greece, three different shapes of *zournas* are found, usually named by their length; in South-Eastern Greece, the short-sized *zournas*, in Continental Greece the medium-sized *zournas*, and in Northern Greece, the long-sized *zournas* (Fig.1). In Table 1, physical elements for three characteristic *zournas*, one for each kind, are shown.



Figure 1. Various Shapes of *zournas*

Size	Short		Medium		Long	
Total bore length (cm)	20.3		34.5		51.5	
Bore diameter (embouchure end) (cm)	0.6		2		1.3	
Bell diameter (cm)	4.5		8		6.75	
Tonehole distance (from embouchure end /diameter (cm)	2.5	0.5	6.2	0.6	7.75	0.8
	4.5	0.5	8.7	0.6	11.25	1
	6	0.5	11.2	0.6	14.75	1
	7.75	0.8	13.7	0.6	18.25	1
	9.5	0.9	16.4	0.6	21.75	1
	11.5	1	18.6	0.6	25.25	1.1
	13.5	0.9	21.4	0.6	28.75	1.2
Register hole distance/diameter (cm)	3.5	0.5	7.5	0.6	9.75	0.8
Embouchure dimensions (cm)						
a	0.6	1.5		a	1	
b	0.9	1.9		a+b	7.5	
c	1	1.9		d1	0.3	
d	0.4	0.6		d2	1	
W	0.6	1		w	1.1	
Zo	0.1	0.1		Zo	0.2	

Table 1. Measures for three different shaped zournas

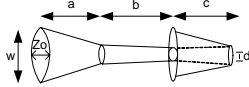

Figure 2. Shape of embouchure for short and medium zournas, corresponding to Table 1.

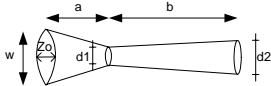

Figure 3. Shape of embouchure for long zournas, corresponding to Table 1.

3. CORDIS-ANIMA PHYSICAL MODEL

All Physical Modeling techniques normally involve the decomposition of an instrument in several components. These components which are mechanical and acoustical systems governed by physical laws are modelled using several mathematical formalisms and simulated with the use of numerical techniques and digital computers.

The major parts of the Zournas as in all woodwind instruments are the embouchure, the bore, and the bell. Even though we could use different formalisms and combinations for each part of the instrument we employed a single one: The CORDIS-ANIMA system.

In CA formalism a physical object is modelled as a modular assembly of elementary mechanical components [1]. A model is represented as a plane topological network whose nodes are the punctual matter elements <MAT> and links are the physical interaction elements <LIA> (figure 5). In this research we proposed two new <LIA> modules. Their block diagrams will be given in the next chapter.

3.1. Bore Model

The use of electrical circuit concept is a standard practice in acoustics. Since CA models are lumped systems it is straightforward to pass from the electrical network to the CA network [2]. In this analogy the basic building modules <MAT> and <LIA> correspond to one-ports.

It is obvious that no wind instrument has a perfectly uniform pipe. In particular, the Zournas bore has several singularities due to its hand made fabrication process. However, all measured Zournas exhibited a conical-like bore. We approximated its non-uniform bore shape with cylindrical sections as conical sections could not be synthesized using by the CA system. The accuracy is dependent on the number and on the size of the cylindrical sections.

Each cylindrical section may be formulated in terms of transmission matrices [3], [5]. These matrices relate directly volume flow q and pressure p at the input/output of each cylindrical section:

$$\begin{bmatrix} p_1 \\ q_1 \end{bmatrix} = \begin{bmatrix} a & b \\ c & d \end{bmatrix} \begin{bmatrix} p_2 \\ q_2 \end{bmatrix} \quad (1)$$

The coefficients are given by:

$$a = \cos\left(\frac{\omega l}{c}\right) \cong 1 \quad b = j \frac{rc}{S} \sin\left(\frac{\omega l}{c}\right) \cong \frac{j\omega r l}{S}$$

$$c = j \frac{S}{rc} \sin\left(\frac{\omega l}{c}\right) \cong \frac{j\omega S l}{rc} \quad d = \cos\left(\frac{\omega l}{c}\right) \cong 1$$

S and l are the surface and the length of each cylindrical section, c is the speed of sound in the air, ω is the radian frequency and r is the air density. The last approximation of equation (1) is valid when the length l of each cylindrical section is small enough (second order terms of l are omitted).

From the theory of electrical circuits we know that this transformation matrix can be implemented by a 1/2T four-pole. In figure 4 we depict this four-pole and its CA mobility analogue [2]. In this analogue pressure p corresponds to tension U and consequently to velocity v and volume flow q corresponds to current I and consequently to force f .

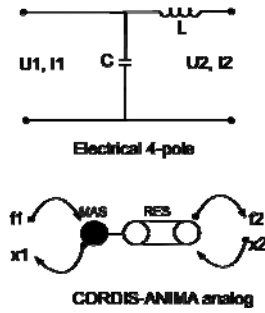

Figure 4 Electrical 4-pole and its CA analog

Equation (2) links the acoustical bore measures to CA parameters.

$$L = \frac{rl}{S}, \quad K = \frac{l}{L} \Rightarrow K = \frac{S}{rl} \quad (2)$$

$$C = \frac{Sl}{rc^2}, \quad M = C \Rightarrow M = \frac{Sl}{rc^2}$$

Since position and force are the two fundamental variables upon which CA modules operate, we are obliged to describe velocity v to position x according to the scheme given by the equation (3) (backward difference scheme). We must be consistent to the metric units used (below we measure the velocity in $m/samples$ and not in m/sec).

$$v(n) = x(n) - x(n-1) \Rightarrow x(n) = v(n) + x(n-1) \quad (3)$$

At the open end of the pipe the pressure is ideally approximated as zero. The electrical model and the CA model of the Zournas bore without losses are presented in figure 5. The losses may be directly modeled with the parallel combination of resistors and inductors in the electrical circuit. In this case a REF module takes the place of the RES module in the CA network.

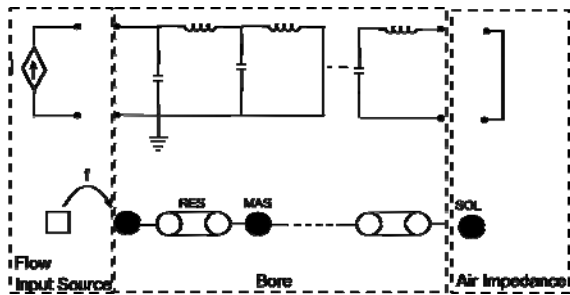

Figure 5. Electrical model and CORDIS-ANIMA model of Zournas bore

3.2. Reed Model

The mouthpiece of the Zournas contains a cane double reed quite similar to the one of the oboe. The reed channel is long and narrow. Due to this particular geometry the double reed instruments prohibit characteristic timbre qualities. Models and sufficient measures of double reed have recently appeared in the literature [4].

According to CA formalism, the reed model must be encapsulated to a <LIA> type module. This imports directly several constraints, primarily concerning the Input/Output structure of the block. The most important requirement is to preserve the action-reaction principle in the mechanical domain and the air flow conservation principle in the acoustical domain. We propose three <LIA> models, which are designed according to the measures and are compatible to the CA syntax. All of them are based on the elementary reed model used to describe single reed instruments. More complicated models are currently explored but are not ready for publication. These models are based on the double-reed mechanism as proposed by Almeida and all [4] and Vergez and all [5]. Other models concerning the reed modeling using the CA formalism can be found in [6]. A good reference for the excitation mechanism of single reed instruments can be found on [7].

3.2.1. Model without hysteresis

This model, which is the simplest one and it is widely used for single reed instruments, approximates the reed system as a memory-less nonlinearity. Using the Bernoulli law and the simple mass-less spring equation for the reed behaviour we get the following equation:

$$q = \frac{p_M - Dp}{k} \sqrt{\frac{2Dp}{r}} \quad p_M = kS_0 \quad Dp = p_m - p_r \quad (3)$$

In this equation, S_0 is the reed opening area at rest, p_r is the pressure inside the reed, p_m is the pressure inside the mouth, q is the volume flow entering the bore, r is the air density and k is the stiffness constant of the reed. p_M is the minimum pressure for which the reed is closed and is called static beating pressure.

The block diagram that represents this model is depicted in figure 6. It can be directly encapsulated in a CA <LIA> module, while using a supplementary input for the reed aperture at rest position.

A simpler way to model the reed behaviour without inertia is with the use of look-up tables. In the first step we compute the flow-pressure function according to equation (3) and the measures, and then we implement this function with the use of a look-up table as can be seen in figure 7 (we can use directly the data form the measured flow-pressure characteristic as well, but without the control of the reed's rest position).

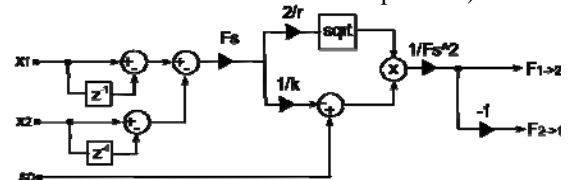

Figure 6. Block diagram of an elementary reed model, encapsulated in a CORDIS-ANIMA <LIA> module

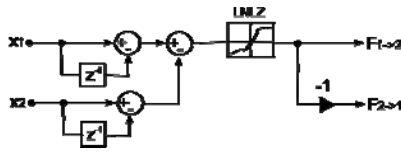

Figure 7. Block diagram of an elementary reed model using a look-up table

3.2.2. Model with hysteresis

In general, double reed characteristic curves present hysteresis according to the measures. For now we do not have measures that permit a hysteresis detection in the flow-pressure characteristic. Nevertheless we present a simple model that permits an easy hysteresis model.

As a system with hysteresis exhibits path-dependence it can be modelled with a finite state machine. The very simple finite state machine of the double reed can be represented using the following state diagram (figure 8). It has only two paths and two state transition conditions. Generally the FSM logic is shown in the same figure.

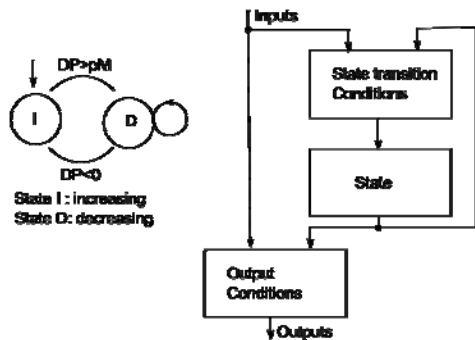

Figure 8. The state diagram of the double reed and the general FSM logic

The block diagram which models the reed with hysteresis and it is compatible with the CA is shown in the figure 9. The experimental data may be fitted to the model according to [4]. In this model the look-up tables can be replaced by the block diagram of figure 4. In figure 10 we present the characteristic of an oboe as measured and fitted to the elementary reed model of equation (3) by Almeida and all. The <LIA> module of figure 6 can describe this type of interaction directly.

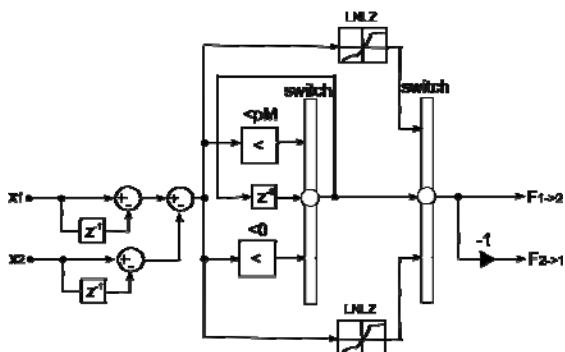

Figure 9. Block diagram of a double reed model with hysteresis

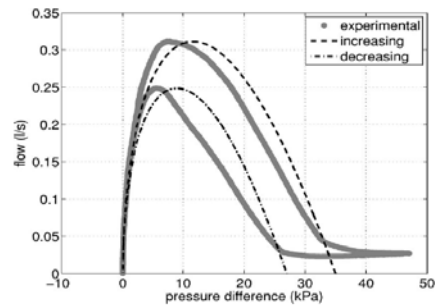

Figure 10. Comparison of the experimental nonlinear characteristics of an oboe with the elementary model of figure 4 measured by Almeida and all [4]

4. CONCLUSION

The current study is still under progress. We expect reed and flow parameters (k , p_M , q vs p) from measurements on real zournas in order to test the model. Use of different reed models will take place. Finally, analysis on the produced sound and comparison with sound features from real *zournas* will define the success of the proposed model

5. REFERENCES

- [1] C. Cadoz, A. Luciani, J.L. Florens, "CORDIS-ANIMA: A Modelling and Simulation System for Sound and Image Synthesis, The general Formalism." *Computer Music Journal* 17(4), 1993
- [2] A. Kontogeorgakopoulos, C. Cadoz, "CORDIS-ANIMA Physical Modeling and Simulation System Analysis", *Proceedings of SMC07*, Lefkada 2007
- [3] D. H. Keefe, *Woodwind Tone-hole Acoustics and the Spectrum Transformation Function*, PhD thesis, Case Western Reserve University, 1981
- [4] A. Almeida, C. Vergez, R. Causse, "Quasistatic nonlinear characteristics of double-reed instruments", *The Journal of the Acoustical Society of America*, 121 (1), 2007
- [5] C. Vergez, A. Almeida, R. Rodet, X. Rodet, "Toward a simple physical model of double reed musical instruments: Influence of the aerodynamical losses in the embouchure on the coupling between the reed and the bore of the resonator", *Acta Acustica* 89(6), 2003
- [6] J. L. Florens, J. Germond, "Reed instruments modular representation and their interactive real time simulation", *Proceeding of ICMC1999*, China, 1999
- [7] G. Scavone, *An Acoustic Analysis of Single-Reed Woodwind Instruments with an Emphasis on Design and Performance Issues and Digital Waveguide Modeling Techniques*, PhD thesis, CCRMA Stanford University, 1997