



HAL
open science

Dynamic Behavior of Concrete: Experimental aspects

François Toutlemonde, Gérard Gary

► **To cite this version:**

François Toutlemonde, Gérard Gary. Dynamic Behavior of Concrete: Experimental aspects. Jacky Mazars; Alain Millard. Dynamic behavior of concrete and seismic engineering, Wiley, pp.1-47, 2009, 10.1002/9780470611555.ch1 . hal-00431708

HAL Id: hal-00431708

<https://hal.science/hal-00431708v1>

Submitted on 5 May 2022

HAL is a multi-disciplinary open access archive for the deposit and dissemination of scientific research documents, whether they are published or not. The documents may come from teaching and research institutions in France or abroad, or from public or private research centers.

L'archive ouverte pluridisciplinaire **HAL**, est destinée au dépôt et à la diffusion de documents scientifiques de niveau recherche, publiés ou non, émanant des établissements d'enseignement et de recherche français ou étrangers, des laboratoires publics ou privés.



Distributed under a Creative Commons Attribution - NonCommercial 4.0 International License

Dynamic Behavior of Concrete:

Experimental Aspects

François TOUTLEMONDE and Gérard GARY

1.1. Introduction

1.1.1. *Meaning of the word “dynamic”*

As distinct from the term “static”, “dynamic” implies the influence of time. A test is said to be “quasi-static” when the effects of time are present, but can be neglected. For a structure test, and for any real test, the effects of time are typically expressed in two ways:

- by forces of inertia resulting from the not equal to zero acceleration to which the elements of structures are submitted;

- by the behavior of each elementary volume of the material depending on the evolution in time of the elementary mechanical values (stress and strain) and possibly of their time derivatives. This dependence is described by the generic name of “viscosity”.

This distinction is strictly linked to the notion of elementary volume underlying the definition of behavior. Actually, the fact that viscosity effects might be the manifestation of inertial microscopic phenomena cannot be excluded. This remark is important in the case of concrete, as considerations about material homogeneity

involve decimeter elementary volumes (but this is not the case with metals for which the elementary volume is sub-millimetric).

Thus, to be quite clear, we will consider the dynamic behavior aspect as limited to the description of the effects of time using elementary mechanical values and excluding inertia effects.

From general physical and thermodynamic considerations concerning behavior laws [MAN 67], we can deduce that the generalized mechanical variables $Q(t)$ (stress) and $q(t)$ (strain) can be related in the following way:

$$Q(t) = G \left[H_{-\infty}^t(q(\tau)); q(t), \dot{q}(t), \dots \right] \quad [1.1]$$

where H describes the loading history. This formulation highlights the fact that these values do not play a symmetric role. The instantaneous mechanical reaction depends on the geometric history, its current value, and the values of its higher time derivatives. Thus, it is not natural to consider stress velocity as a behavior variable.

If we limit our attention to formulations likely to be easily integrated into calculation codes, the relation expressed in equation [1.1] can be re-written in the following incremental form:

$$d\sigma = f(d\varepsilon, \dot{\varepsilon}, \ddot{\varepsilon}, \dots, \alpha_i \dots) \quad [1.2]$$

The values α_i are internal parameters that take process history into account. Their evolution has to be described as a complement to the relationship in equation [1.2]. Their dependence on the history of the process explicitly results in their loading and unloading paths being different. The values playing a part in equation [1.2] are tensors. We can see the complexity of this relation. In most cases, the simplifications carried out involve discarding strain time derivatives higher than 1, and expressing the strain speed using a scalar value. Such simplifying assumptions are justified for two types of reasons. Firstly, programming laws into codes will be simplified by doing this. Secondly, an insufficient variety of dynamic tests is available to identify more parameters. For this reason, from this point onwards, we will refer to “strain velocity” without going back over the definition.

As far as strain velocity is concerned, it is standard practice to study its effects on long time scales revealed through creep. Even though creep tests can clarify the analysis of dynamic tests, we will not be considering them. The experimental aspects of creep tests have no dynamic aspects, as typical strain velocities

implemented are around 10^{-10} s^{-1} , as compared to “static” test standard velocities that range from 10^{-6} to 10^{-5} s^{-1} , and the strain velocities reached during “hard” shocks on civil engineering structures, which are usually in the range of 0.1 and 10 s^{-1} .

These elementary considerations understood, it appears that a critical factor in the experimental characterization of concrete behavior is discarding the inertia terms. The problem is more delicate with concrete (a brittle material) than it is with metals. As a matter of fact, the first manifestation of inertial effects on a sample submitted to dynamic loading is the transient response observed when the time taken by elastic waves to pass through the sample (the transfer time) is significant relative to the test’s time duration. When studying this problem, the pertinent time-dependent parameter is not the strain velocity (which, in any case, is not well-defined in the transient phase), but the loading time relative to the transfer time. If sufficient strain levels are reached in very short periods of time, the sample could fail before a homogenous stress and strain state, *measurable as an average*, could be reached. In fact, low amplitude traction strains (ranging from 100 to 150×10^{-6}) lead to material failure. Test analysis is generally difficult. For common sized samples (centimeter scale), we cannot go beyond 1/s average strain velocities when conducting a quasi-static test analysis. This feature of brittle materials can be exploited advantageously, and is used in scabbing tests (see section 1.3.1).

This limitation is far less a problem with metals, where important local strains arise, but do not cause failure. Such a situation can only occur in concrete if particular conditions that guarantee mechanical field homogeneity exist to prevent cracking. This is the case when tests are conducted in strong confinement (under which circumstances, concrete behavior is described by plasticity-type models). As far as metals and most polymers are concerned, it is also important to take thermo-mechanical coupling into account, due to the adiabatic feature of dynamic tests. This effect can only be neglected when failure occurs under low strain for which the dissipated heat remains low: with concrete, it can also be neglected in confinement tests, since we can presuppose a low thermo-mechanical coupling.

1.1.2. Reminders about dynamic experimentation

1.1.2.1. Specificity of dynamic tests

As far as statics and dynamics are concerned, it is reasonable to consider sample analysis in a separate section, along with the overall measures it involves (generally carried out on the peripheral part of the material). This is the second aspect mentioned in the introduction.

The first difficulties encountered in dynamic experimentation fall under the first category mentioned in the introduction. They are linked to transient effects inside the machine and the associated sensors: the balancing time of the machine and its sensor array (elastic waves moving back and forth several times) are not negligible relative to the length of the test. Thus, carrying out quality measures often requires a *transient analysis of the response of the machine itself*. Hence, in a real situation, characteristic testing times have to be compared with the acquisition chain and the sensor pass-band. If the acquisition frequency is not far higher than the frequency of transient signals, the observed result can be completely modified by the measuring chain, and even average values can be wrong.

1.1.2.2. Hopkinson bar test

For average strain rates in excess of 50/s, because the transient effect inside the test machine cannot be neglected, a way round the problem involves explicitly taking wave propagation phenomena into account, using a bar system. Whilst the transient analysis of three-dimensional structures is too complex to be taken into account efficiently, using “one-dimensional” bars makes it possible, as we will now explain.

1.1.2.2.1. A description of the bar test

To carry out a dynamic compression tests with Hopkinson bars [HOP 14] (also called the SHPB (Split Hopkinson Pressure Bar) system, or Kolsky bars [KOL 49]: named after the first person to use the system in its current configuration), a small sample is placed between two identical long bars with a high elastic limit relative to the tested material (Figure 1.1). Strain gages are glued to both bars. Due to a projectile, a compression longitudinal elastic wave is induced into the input bar. Part of this gets reflected at the sample-bar interface, whilst another part is transmitted to the sample before inducing a wave in the output bar.

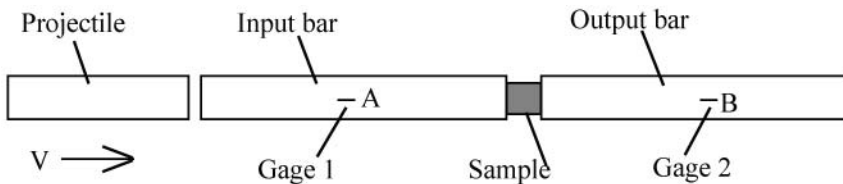

Figure 1.1. Hopkinson bar assembly

The waves at points A and B are determined by measuring and recording the structurally-associated longitudinal strains. The need to know A, the incident wave induced by the impact separator, and the reflected wave B, which depends on the

reaction of the sample, arises because we need to find the optimal position of the measuring point at the middle of the bar. On the other hand, considering the bar as one-dimensional does not allow us to place the strain gauge too near an end. A typical recording for a concrete sample compression test is shown in Figure 1.2.

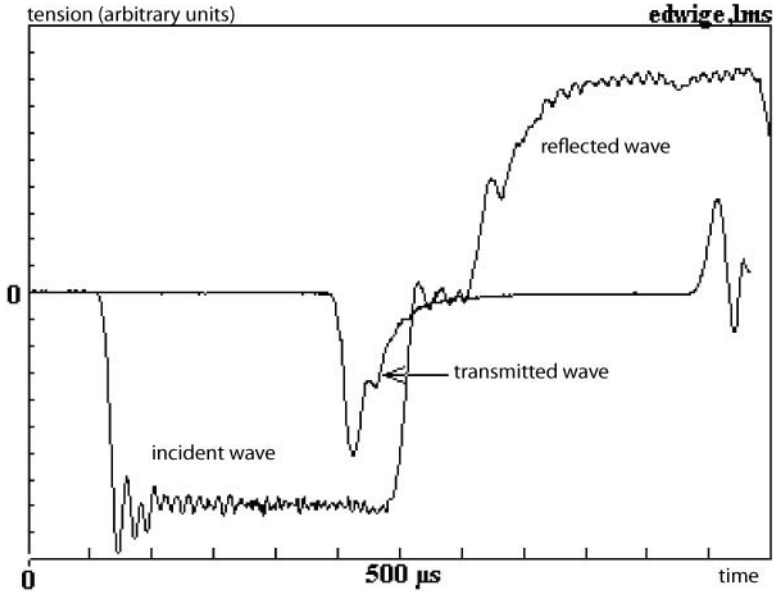

Figure 1.2. *Compression test on a concrete sample (40 mm diameter aluminum bars): basic waves*

Next, the waves have to be carried to the contacts between the sample and the bar. Then we can calculate the stresses and displacements (by integrating the velocities, which are directly accessible) on the corresponding faces.

The particulate velocities at the input and output faces can be written respectively as:

$$V_e(t) = -c \left[\varepsilon_i(t) - \varepsilon_r(t) \right]$$

$$V_s(t) = -c\varepsilon_t(t)$$
[1.3]

The forces on the input and output faces are respectively:

$$\begin{aligned} F_e(t) &= S_b E \left[\varepsilon_i(t) + \varepsilon_r(t) \right] \\ F_s(t) &= S_b E \varepsilon_t(t) \end{aligned} \tag{1.4}$$

Measures on the two opposite faces of the sample allow estimation of strain field homogeneity by comparing the forces on each face (section 1.3.2, Figure 1.12). We note that for this test, the assumption of homogeneity in mechanical fields is hazardous. As a consequence, the notion of average strain velocity is also hazardous. In section 1.3.2 we will see the best way to use the available measurements. Thus, we should stress that the Hopkinson Bar leads to overall values of *loads and displacements on both sides of the sample*. All mechanical quantities are obtained by making additional assumptions completely separate from the test facilities. These have been widely reported in the literature [NIC 80].

1.1.2.2.2. Limitations of the conventional system

Accurate analysis of wave transport

To carry out a precise virtual wave transport between the measured points and the sample (forward transport for the incident wave and backward transport for the others), the three-dimensional feature of the bars need to be considered, and the *dispersal correction* must be introduced using a signal treatment technique. This parameter corresponds to signal modification during transport. An accurate time calibration (to within a micro-second) is also necessary [ZHA 96]; it is especially important for measurement of small strains, and thus for brittle materials such as concrete.

Multi-axial characteristics of the test

The uniaxial characteristic of the test is also an approximation. Let us examine this aspect in the case of compression. Whenever the material presents a Poisson effect, the longitudinal strain comes with a lateral strain (as is the case in statics if the support conditions are well controlled), which is opposed by radial inertial effects. This causes an induced confinement. The confinement explains the obvious sensitivity of concrete to strain velocity that is universally observed in dynamic compression (see section 1.3.2).

Measurement duration

The proportionality between the mechanical values associated with a wave inside a bar, on which the Hopkinson bar technique is based [1.3]-[1.4], only applies to a

wave propagating in a single direction, which requires measurement of the incident wave (propagating one way) separately from the reflected wave (which propagates in the other direction). This limits the measuring duration to ΔT ($\Delta T = L / C$),

C being the propagation velocity and L the length of the input bar. ΔT is thus a function of the length of the bars. Consequently, for a behavior test, the total strain cannot exceed the product of the average strain velocity and ΔT . For instance, measuring duration will not exceed 400 μs ($C \approx 5,000$ m/s) for a 2 m long aluminum bar, and the total strain will be limited to 4% for a test with a 100 s^{-1} average strain velocity. Because of this limitation, even with concrete (for which high strains are unlikely to be reached), the conventional Hopkinson bar system will not allow tests at average strain velocities lower than 50 s^{-1} . On the other hand, for reasons explained in section 1.2.1, traditional machines used without specific precautions do not give reliable results at lower velocities. Besides, their superior limit is not clearly established and is determined to an extent by the material being tested (the test piece). The machine must be used in a particular way; it varies between 1 s^{-1} and about 10 s^{-1} . However, a recent experimental technique using bars [BUS 02] that covers this problem now exists.

1.1.2.2.3. Difficulties inherent to dynamic measurements

The dynamic test facilities have numerous limitations, especially for stresses other than simple compression or small strains. This limitation mostly affects low strength stressed materials (impedance adaptation and high strain problems) and brittle materials (low strain at failure).

The Hopkinson bar example illustrates the generic difficulties quite well. The very short loading times do not enable us to carry out multi-axial dynamic loadings easily, and it is not easy to synchronize loading with two (or three) orthogonal Hopkinson bars. If synchronization is tricky in dynamics, it is all the more so when piloting the test. Therefore, we cannot (for now) contemplate carrying out tests under controlled multi-axial loading (deviatoric, for example), as is required in a quasi-static mode. The need to control the loading and the difficulty in carrying out dynamic displacement measurements limits the potential tests to a very small number, which are described, along with their specific problems, in sections 1.2 and 1.3.

1.1.2.2.4. Compression tests with confinement

It is quite easy to superimpose quasi-static confinement on a dynamic compression test. A cell in which a gas pressure confinement can be maintained during the compression test is described in [GAR 99]. Some authors have proposed a bi-axial loading scheme, where the secondary static stress is applied using a jack [WEE 88]. For higher confinements (necessary if we want to study compaction of

concrete, for example), a metal cylinder can be used [GAR 99]. In this case, confinement pressure is not studied, but can be measured during the test by assuming the (most often elastic) response of the confinement ring is known (as in an oedometric test). Another way to carry out high confinements involves using the “plate on plate” test developed to study the high-speed spherical behavior of metals. It is a plane strain-loading test, the inverse analysis of which is based on behavior modeling. High confinement there is associated with very high strain speeds.

1.1.2.2.5. Traction tests

A conventional traction test can be carried out with a Hopkinson bar [REI 86]. If we consider only global measures, the main difficulty is due to keeping the sample in contact with the bars. To avoid having to resort to assemblies leading to impedance failures, it is reasonable to glue the sample to the bars. Some authors [TED 93] have had the idea of using the Brazilian test again in dynamics. In this case we have to check that the conditions of strain homogeneity are compatible with the assumptions. Finally, the spalling test [DIA 97] allows an accurate measurement of the average stress just before failure, but its interpretation is difficult as it is between the classical traction test and the fracture test (toughness measurement).

1.1.3. Identifying the behavior of concrete under fast dynamic loadings

When identifying the dynamic behavior of concrete, we are confronted with a series of typical problems for each high-speed behavior identification test. Some of these problems are increased by the nature of concrete, which is the reason why we prompt the reader to be very cautious when using experimentation signals or results.

Due to its structure in aggregates, where it is mixed with sand and hardened cement paste, concrete can be a highly heterogenous material, and the size of a representative sample is not always an easy thing to state. As far as statics is concerned, a 2 slenderness cylinder, over five times as big in diameter as the aggregates, is the lowest volume necessary to obtain stable properties representing the material in these tests, particularly as far as strength is concerned, otherwise “scale effects” will be observed. Such a constraint raises several types of problems:

- for standard concretes, in which the maximum size of aggregates ranges from 20 to 25 mm, the dimensions of test samples (diameter over 10 or 12 cm, mass over 5 kg) involve resorting to important energies, particularly for high speed tests, which involves sometimes tricky technological arrangements;
- to avoid this difficulty, tests are often carried out on micro-concrete, mortar or cement paste samples. Transposing these results to structure concrete requires a critical analysis, mainly because the volume fraction of cement paste (generally

considered as the viscous element of the composite) is not always constant. In the same way, the propagation of waves disrupted by the module differs between cement pastes, and aggregates can also be different depending on the composition of the studied material;

– even if we managed to identify the intrinsic properties of the material on big enough samples, for many structures, the “representative material point” size is important compared with the dimensions of the smallest pieces (building shells about 20 cm, bridge webs from 30 to 45 cm). Furthermore, significant stress variations on the scale of the structure can be discerned over short distances of the same order of magnitude as the dimensions of the test sample. What is then involved is the application of continuous medium theory, which is based on the assumption – generally not well verified – that the material point is infinitely small compared to the structure;

– a problem (which occurs in statics too) that becomes crucial as far as the dynamic interpretation of tests is concerned is that the sample is not submitted to an homogenous state of strain and stress owing to its size, and has to be considered as a structure submitted to transient loading.

Because concrete is a brittle material (like most geomaterials, concrete can only withstand very weak extension strains and its apparent “failure” takes place for a compression strength about 10 to 20 times as strong as its traction strength), most of the time, in practice, while interpreting the tests, we must consider:

– that we are dealing with an elastic homogenous material (which implies the size precautions referred to above): the assumption is necessary for relatively low velocities or low strain levels, in continuity with the quasi-static field. It is not good enough to interpret the totality of a test when the speed increases, since the maximum stress is reached when localized cracking has been reached significantly on only a part of the structure;

– that beyond the stage corresponding to localized cracking, the test sample can be modeled as a cracked structure where damage concentrates in the crack area, which corresponds to fracture models;

– that beyond a stage corresponding to a distributed deterioration (which corresponds to the bonding material crumbling away), the material can be described by combining damage and plasticity models.

Hence, at the material failure of the sample, the interpretation of the tests requires different analysis models, regardless of whether we are mainly in a deviatoric behavior with a possible extension direction allowing localized cracking, or in a mainly “spherical” behavior, and depending on the stress peak being identifiable or not.

It is important to note that because of the weak growths withstood by the material at high velocities, experimental precautions have to be taken – especially because of transient effects, in dynamic experiments where limit conditions are difficult to control. In experiments where an “energetic” approach is privileged, this aspect is also important: the inertia of the test sample cannot always be neglected with regard to that of the test machine, and the energy dissipation through damage on the support, or through contact with the impact separator can be important compared with the energy supposedly dissipated by the “normal” cracking expected in bending.

Finally, a delicate feature of concrete is its porosity: it has such a tortuous network that water exchange times with the environment are quite long (about 10 years for the representative volumes considered above). We can consider the hydration state of the sample as constant during dynamic tests, which is not the case for shrinkage or plastic flow tests. However, important relative pore moisture and mechanical state coupling, together with frequent cracking due to the stress levels reached when desiccated, begins at the sample’s surface and/or their environment as soon as they are fabricated. In at least one stress and velocity field ([DAR 95] [TOU 95a]), researchers have shown that the partly water-saturated feature of the porous network explains the modification of apparent mechanical properties: these are generally called “velocity effects” in the literature.

In following sections (1.2 to 1.4), we will detail the arrangements, test type by test type, used to analyze the results and infer the indications and modifications required to calculate and understand the behavior of fast dynamic loading concrete structures. The actual and measured behaviors are summarized in a rational way in section 1.5.

1.2. Tests in which the transient rate has little influence

In this chapter, we will deal with behavior identification tests that, for reasons developed in section 1.1 can have a “quasi-static” interpretation.

Two test families can be distinguished. The first is derived from typical concrete characterization tests and emphasizes growth or cracking failures. This is called deviatoric behavior, and is the failure kind that is also, indirectly, the cause of collapse observed in compression and even in biaxial compression. The second test type corresponds to “volumic” behavior, which can seldom be observed in ordinary structures, except in relatively confined areas where specific reinforcement by the surrounding material ensures tri-axial confinement at high velocity: concrete areas directly submitted to impact and those close to an explosive charge or perforating projectile are examples.

Combining both types of information in statics enables a definition of failure or plasticity criteria closed on the hydrostatic compression axle, as opposed to the “intrinsic curves” (Coulomb criterion), the validity of which is preferentially ensured when an extension direction is possible.

1.2.1. Tests involving deviatoric behavior

1.2.1.1. High-speed press machines and traction tests

Because of the difficulties connected with carrying out dynamic tests, most authors use privileged uniaxial tests. Owing to the basic feature, traction behavior identification stands out, and has given rise to a great number of tests. In order to ensure continuity in the geometry of test samples, by controlling the loading application speed and considering its limited artifacts, a direct traction test on a cylindrical specimen has become essential. This is detailed in [HOR 87], [REI 82] and [TOU 95a]. With particular precautions, this test can actually be carried out on conventional servo-controlled machines with load build-up speeds ranging from about 0.05 MPa/s (which is the standard loading rate for standard identification tests) to about 10,000 times this load, with identification at still higher speeds of the order of 50 GPa/s possible on the same specimen type thanks to the modified Hopkinson bar (SHB).

The necessary precautions particularly involve:

- choosing to glue the specimen in place with centering and a rigid (without spherical pairs) mounting onto the press to limit looseness which is a source of interfering moments;
- choosing aluminum hard supports to limit the transversal strain divergence at both ends of the specimen;
- controlling the hydration state of the specimen [TOU 95a];
- choosing a not too important slenderness ratio (1 to 1.5) to limit potential bending;
- gauge extensometer or extensometers fixed in the middle of the specimen to avoid the deformations due to the glue joint;
- using specimens with adequately sized diameters considering the maximum size of the aggregates, and if possible core cylinders for better homogeneity of the material and to avoid scaling effects [ROS 92a].

With a sufficient automatic control and oil flow unit, and potentially using a preload to carry out high velocity tests, we can consider that the load build-up speed

is rather constant during the test. The propagation speed of the waves within concrete – about 4,000 m/s, the standard size of specimens (10 cm) – and the traction failure stress (4 to 10 MPa) limit the quasi-static interpretation of this kind of test, results typically showing a divergence about 10% between the specimen's input stress and output stress.

The measurements typically carried out during this test are of the applied force as a function of time, and of the average longitudinal strain at the center of the specimen (extensometer gages or sensors for which we have to check that the inertia will stay weak and the fixing will be ensured during the test). Taking into account the small size and fixedness of the assembly, we can consider that there are no differences between the measured force and the force applied to the specimen, so we can assess traction uniaxial behavior by eliminating time. In such a test, the specimen behavior corresponds quite well to brittle elastic behavior up to localized cracking. Localization brings about loss of the homogeneity of the strains, and an almost instantaneous decrease of the load.

Going through these tests, which implies expressing the maximum measured stress according to the “load build-up” parameter in a logarithmic diagram, typically allows us to define a traction rate effect corresponding to the strength relative increase.

1.2.1.2. *High-speed press machines and compression tests*

The second most conventional test that can be performed at high speed is the compression test. It enables us to define a compression “rate effect” from the measurement of the maximum strain reached [BIS 91]. The size of the test sample necessary to free oneself from the size effect and to ensure the correct strain level reached lead to strict constraints on press dimensions, unit power and the jack flow rate. For this reason, a great number of the tests described in the literature were carried out on mortar, cement pastes or micro-concrete [HAR 90]. As is the case in traction, it has proved possible to look for a size compatible with the higher speed test performed with Hopkinson bars [DAR 95].

As it is difficult to stop the jack when its speed has been stabilized, few test reports have included extensometer measurements [BIS 91], measuring the load obviously remains the main data. For standard size specimens (10 cm), considering the wave propagation speed and the maximum stress reached, the load build-up rate beyond which the sample cannot be deemed to be in a stationary process is about 10 times as important as it is in traction tests, which correspond to the strength ratio. When expressed in terms of strain rate, the threshold is about 10 instead of 1 s^{-1} [MAL 98].

The incidence of superfluous interference moments is generally less important than it is in traction tests; however, the precautions to be taken to avoid restricting transversal strains are as important as in statics, especially for specimens with slenderness ratios below 2. To this end, we can mention lubricating the faces or using aluminum. The quality of the stress transmission surfaces is essential to avoid premature concentration of stresses.

We note that as in statics, and even for specimens that are simply laid, the relative displacement (including interface crush and deformations at the ends of the specimens) cannot result in a reliable indication of the strains of concrete in its standard part, the error typically ranging from 30 to 100% [BOU 99]. As in statics, failure obtained in compression tests begins with transversal extensions. The traction rate effect results in an “inertial confinement”. However, the maximum stress is only reached when the cracks parallel to loading direction meet, allowing either buckling in the “small columns” formed inside the test body, or shear localization. As a consequence, interpreting the strength evolution, where load build-up speed is the only parameter, becomes complex.

We could not find any references to tests deriving from standard quasi-static identification of multi-axial behavior with prevailing deviatoric behavior (bi-traction, pure shear, bi-compression), at least not in areas where transient test characteristic can be neglected. As a matter of fact, the most frequent cases of dynamic multi-axial behavior identification use unidirectional loading with a Hopkinson bar [GAR 98], [LOU 94] and [WEE 92], while confinement or loading in the other direction is often “static”. These tests will be described in section 1.3. Such a situation can indeed be explained by the difficulty in controlling and synchronizing dynamic loadings, even at the “low” speeds reached by conventional presses or jacks. Furthermore, taking the properties of concrete into consideration, the regulations rarely take multi-axial behavior into account. As a result this lowers the validation of high velocity dynamic models adapted to concrete, in situations other than simple traction, uniaxial compression or compaction.

1.2.1.3. *Tests with small plates or beams submitted to pressure loading*

Considering the difficulty in carrying out dynamic loading with mechanical application of the loads, some authors perform controlled loadings on mini-structures (small rectangular plates, beams or small plates), using a pressure loading generated by an explosion. The purpose is then to identify the bending behavior, the bend-moment law being material information directly transposable to the calculated structure, taking into account the similar nature of the tested material and the geometric and energy similarities – called Hopkinson’s – on the load. Detailed experimentation of this kind will be described in [BAI 87] and [BAI 88]. The limitation on the energies that can be used in a laboratory forces the use of

centimeter thick test elements, therefore generally of mortar (or possibly fiber-reinforced) rather than concrete.

The loading process links the level of the applied overpressure with its duration and load build-up speed. However, interpreting the trial remains simple in so far as the load build-up times can be considered as very short compared with the specific period of the structure. Thus, we have what is called a pulse loading: the overpressure time, which causes the structure to start vibrating, is very slightly ahead of the latter's peculiar period, which is then in a free-vibration system. As the probable area of maximum strain and even failure is known, the relevant section can be instrumented in a preferential way. Therefore, we can measure the traction by bending the final strain and the final bend. Note that shortly before failure, the strain of the compressed side is slightly inferior to that of the opposite side (the start of non-linearity which could be representative of micro-cracking). Since the structure is undergoing free vibrations, the deformations should be linked to the stresses generated from the by-pulse loading, which implies that a dynamic analysis can be used to calculate the moments to link to the bends within the scope of behavior law identification. Nevertheless as long as we stay at moderate loading levels and deal with the behavior just before a brittle material fails, an elastic analysis is satisfactory. The divergence from elastic behavior can be identified "at a quasi-static speed".

1.2.1.4. *Shock tube tests on plates*

The principle of a gas pressure by-pulse loading can also be applied by resorting to a uniform loading the value of which is controlled thanks to a tube used as a wave guide and called a *shock tube*. Using such a device is quite conventional for testing industrial equipment in the defense field. Using the device for structure elements was developed more recently [TOU 93]. Using explosives is limited and the loading profile as well as its spatial repartition is better controlled than open-air explosions. In so far as the conditions at limits can also be well controlled, we can directly access to the behavior of a bending plate, which represents "basic" data for the structure designer [KRA 93] or a simple basic situation to validate a behavior model [PON 95, SER 98a].

The innovation of this trial was that it generated loading by means of a well-controlled air shock wave (Figure 1.3). By using the closed tube, for the same plate with the same support conditions, it is possible to carry out quasi-static loadings by slowly inflating the whole tube. As an example, a 35 m long tube, 66.6 cm in diameter, was used to compile an important experimental database about concrete and reinforced concrete plate bending parameters [TOU 95a].

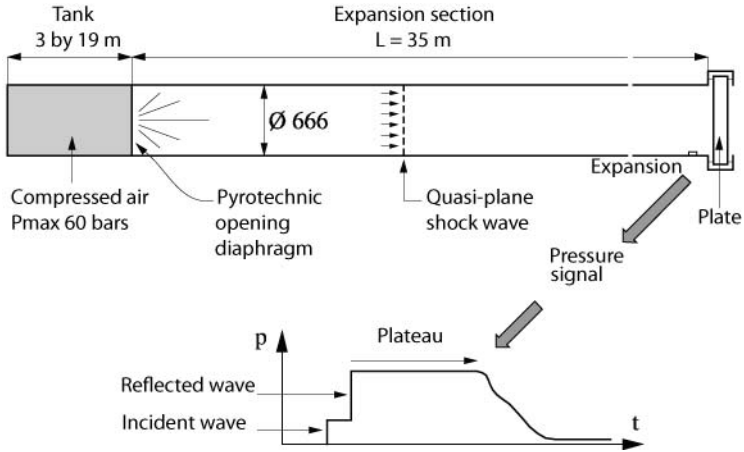

Figure 1.3. Skeleton diagram of the shock tube trial (from [TOU 95a])

Considering the inner diameters of the tube and the support area (82 cm), to preserve the cylindrical symmetry of the test, the test sample is a “thin plate” (thickness/span $< 1/10$) 900 mm in diameter and 8 cm high. It has dimensions compatible with the performances of the tube (allowing it to actually reach failure requires using a concrete with aggregates that are not too small, or realistically standard reinforcement (welded wire mesh), or fiber reinforcements). We can note the particular care taken to achieve limit conditions close to those for an ideal simple support, the circular slab being “pinched” between the humps of two massive guides, a thin rubber-steel sandwich (a 3 cm wide ring) allowing absorption of geometric defects and distribution of the clamping load. Its stiffness has been measured, and control of the displacement and acceleration on the supports during blasts enables analysis of the bending of the support slab under uniform loading on a driven reference line.

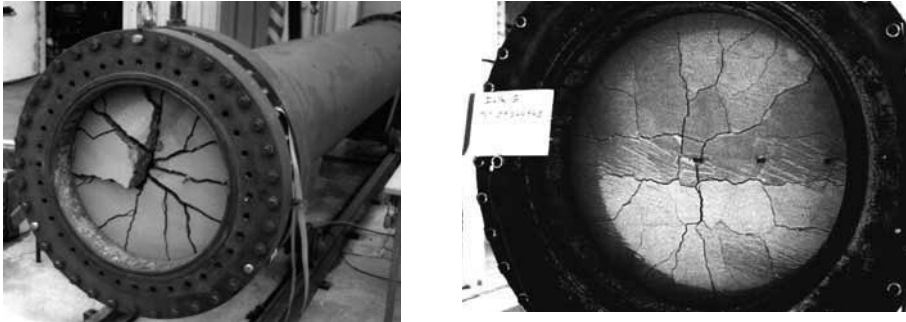

Figure 1.4. Shock tube failure trials for a plain or reinforced concrete slab (from [TOU 95a])

In addition to excellent loading control and a size adapted to a well controlled trial on “realistic” concrete, the advantages of this test are the realistic representativity (bending is obtained with maximum deformation speed typically ranging from 0.01 s^{-1} and 1 s^{-1} , which corresponds quite well to the “hard” shock range) and geometric simplicity (radial symmetry is preserved up to cracking) which make it possible to validate a calculation model as well as for comparing various materials. The relative ease of interpretation stems from the fast loading building up (about $10 \mu\text{s}$ for a maximum deformation reached in about 1 ms) and from the absence of pressure gradients on the loaded face. We can consider that the plate is loaded instantly (vibration setting with a first deformation peak which is particularly intense compared to static loading), but with a bearing constant loading, which allows a stationary vibration rate to be set up before unloading. A “conventional” modal analysis enables access to local stresses and strains, at least until cracking starts.

In [TOU 95a], the details about the instrumentation implemented to characterize strains in test samples in these types of trials are presented. We have seen that in a series of plain or reinforced concrete plates with strength in the range of 35 to 120 MPa (Figure 1.4), we are able to show the progressive deterioration of the modal response (frequency drop, increasing damping), the appearance of deflection, plastification of the reinforcement, crack progression (which is sometimes delayed with regard to the maximum strain rate) and the collapse mode type (shear force/bending competition) the respective appearances of which can be justified by limit analysis-inspired calculations [TOU 95a].

1.2.2. Tests with prevailing spherical behavior

When loading has a strong tri-axial component, concrete undergoes a global reaction resembling that of a coherent material, even when it has failed on a microscopic scale, which is the case for confinements over 10% [GAR 99]. The models used to describe this are generally plastic models (not necessarily standard and usually coupled to deviatoric and spherical behaviors). In these cases, even high strain gradients do not bring about failure or localization, and the concrete sample can be analyzed as if composed of a homogenous material.

1.2.2.1. Slab-plate tests

In the standard case [ZUK 82], loading is caused by the impact of two identical plates. The impact speed is known. On the unused slab, a rear face rate measurement (usually made using laser interferometers) is conducted. Another version of the trial involves applying the same type of loading (in plane strain), using an explosive. The shock induces a plane shock wave propagating at a velocity D . Discontinuities of material rate u , pressure P , volumic mass or mass volume V and inner energy E are associated with this wave. Assuming the material speed ($u_0 = 0$) and pressure ($P_0 = 0$) initial conditions are zero, we can infer from the Rankine-Hugoniot conservation equations that:

$$\begin{aligned} V &= V_0(D - u) / D \\ P &= Du / V_0 \\ E &= E_0 + P / 2(V_0 - V) \end{aligned} \quad [1.5]$$

As the time of the shock is known (by contact measurement for example), measuring the free rear face speed allows us to locate the moment when the wave arrives and to measure D . It also allows us to calculate u . Thus, one test establishes a relationship between P and V , and also between D and u : these are called “shock polar curves”. To deduce a strain-stress uniaxial relationship from them, we will have to make a hypothesis about the behavior model of the material.

For metals and high strength shocks, the elastic response is neglected, and we assume that the plastic behavior is purely deviatoric (without any volume variation). Strictly speaking, concrete behavior analysis should be different. Each test gives a point on a curve. The “Hugoniot curve” links pressure to material physical speed and the “shock polar curve” links shock speed with material speed (objective measurements). There is therefore no direct way of converting this to mechanical values that geomechanical engineers are familiar with.

The plate-plate test is a relatively pure trial. However, it has to be interpreted, is difficult to implement, and only can only inform us about concrete compaction behavior at very high strain rates (above 10^5 s^{-1}).

1.2.2.2. Hopkinson bar tests with strong confinement

This test was developed at the LMS in co-operation with LMT Cachan [GAR 99]. A cylindrical specimen is confined within a metal cylinder (Figure 1.5). It is loaded using a large diameter (80 mm) steel Hopkinson bar, which allows the use of test samples large enough in comparison with aggregate size to be adequately representative of the material.

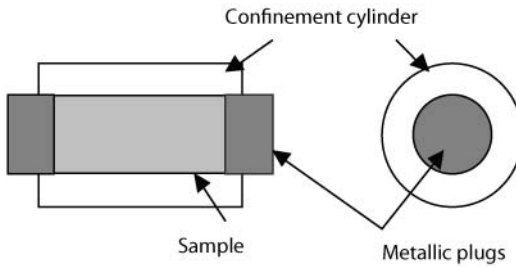

Figure 1.5. *Confined sample for Hopkinson bar test (from [GAR 99])*

The complete collection and analysis of the signals recorded on the bars (described in section 1.1.2.2) allows the measurement of the forces and displacements applied on both faces of the sample.

When the input and output forces are equal (which is the case shown in Figure 1.6) and we can assume an homogenous state of stress and strain, the stresses, strains and axial strain speeds can be deduced.

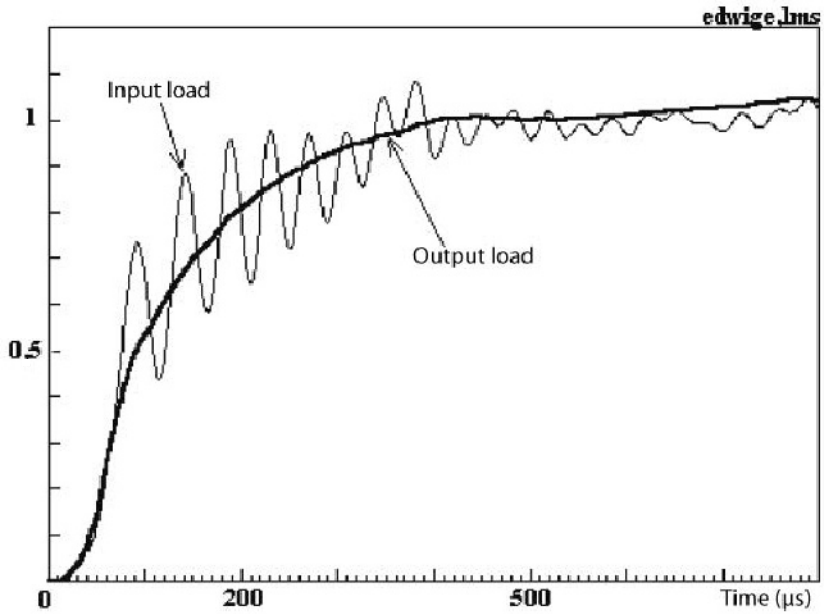

Figure 1.6. *Static and dynamic volume-pressure relationship*

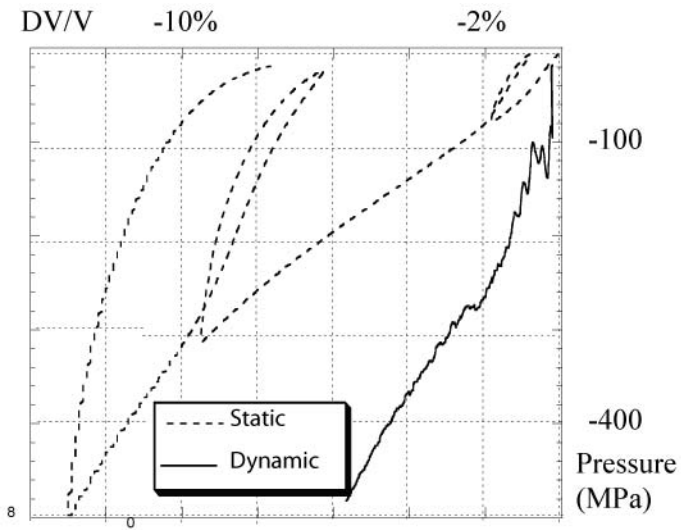

Figure 1.7. *Static and dynamic volume-pressure relationship*

The behavior law of the metallic ring is known. A thick enough ring to remain in the elastic field allows the application of strong confinements. Using a ring made of material that enters the plastic field (brass for example) will enable controlled confinement to be applied. Thus, measuring the transversal strain of the ring allows the confinement to be calculated, after which we can calculate the values that are usually dealt with in geomechanics. As an example, Figure 1.7 shows evolution of the volume-pressure relationship compared to the same relationship obtained using a static trial.

1.3. Tests with transient phase conditioned interpretations

1.3.1. Tests involving mainly traction behavior

1.3.1.1. Modified Hopkinson bar

As explained in section 1.2.1.1, traction behavior is essential for characterizing the failure of brittle geomaterials like concrete, which is why adapted tests have been designed to obtain this data for high speeds, and has been widely studied.

The design has been achieved, mainly thanks to modified Hopkinson bar configurations in which the specimen is glued between the input and output bars, where it is submitted to traction produced by a shock to a retaining shoulder at the end of the input bar. The main results with this technique were obtained on the device of the University of Technology in Delft [REI 86] and [ZIE 82] between 1980 and 1995. The tested specimens are typically core sampling specimens 74 mm in diameter (the same diameter as the bars), with a 1 to 1.5 slenderness. The duration and energy of the shock which generates the traction wave depends on the mass used, hydrostatic pressure and the number of dampers inserted between the masses whose fall is triggered and the lower input bar shoulder.

In practice, as we want the shock to be intense enough to cause specimen failure, and the loading build-up rate to be constant during the trial, the device allows loading rates ranging from 4 to 200 MN/s, about 100 to 1,000 above the rates reached with conventional press machines with similar specimen geometries.

The analysis of specimen loading uses the transient analysis described in section 1.1. The quality of glueing interfaces and the nature of the aluminum bars contributes to impedance compatibility between concrete and the loaded material, so an important part of the wave is transmitted to the specimen and the obstacles to transversal strains are limited. We have verified that the transmitted-wave signal gives a precise measurement of the average stress developed inside the sample – after conversion into stress and calibration in time.

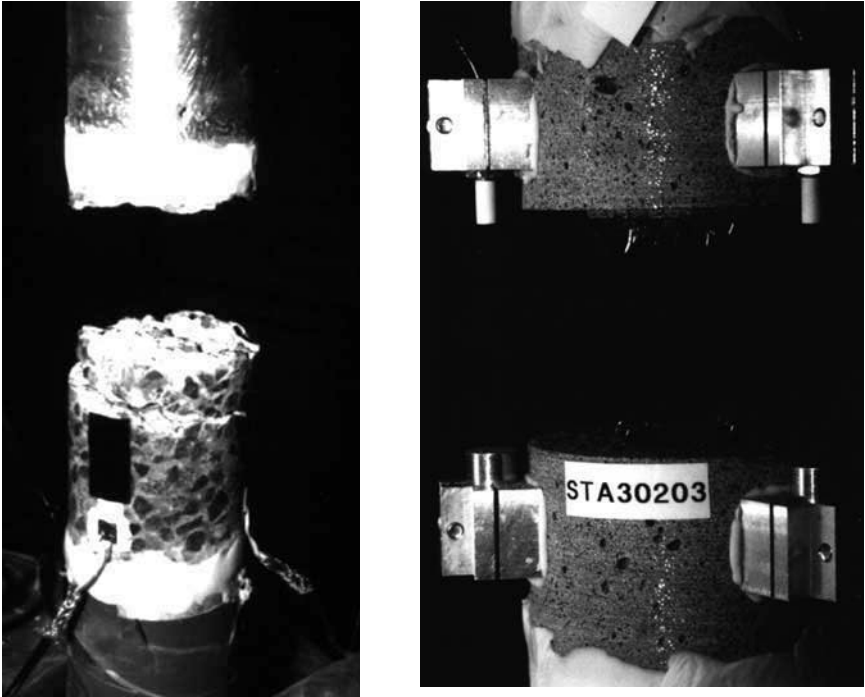

Figure 1.8. *Direct traction tests on Delft University's Hopkinson bar, plain concrete and very high performance concrete*

The simultaneous measurement of the strains on the specimen (Figure 1.8) is made possible either by extensometers gages glued to the sample [TOU 95a] or by pre-slotted fiber concrete (where the measurements concerns crack opening), by gages fixed directly on the sample [TOU 99b]. For the speeds considered, the time delay between stress and strain signals is about $220 \mu\text{s}$, whilst the space difference is about 1 meter. The “suitable” loading time (from 0 to maximum load) ranges from 100 to $500 \mu\text{s}$, and sampling is carried out at 250 kHz. The excellent stress-strain linearity obtained confirms the validity of the hypotheses. Nevertheless, considering the time to go through the specimen (about $25 \mu\text{s}$, i.e. a difference about 1 MPa), the rates reached limit the interpretation as far as sample homogeneity is concerned.

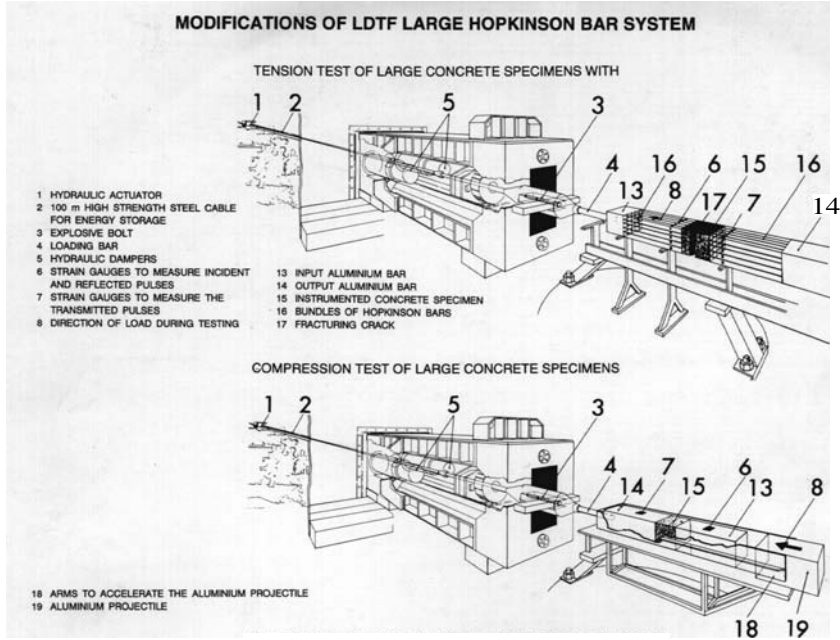

Figure 1.9. *Ispra Centre device for big sample testing*

To improve understanding of the mechanisms of traction failure and crack dynamic propagation, a specific device has been developed for effort transmission and measurement and is included in the large-scale dynamic test equipment (LDTF) at the European Research Centre Ispra [CAD 01]. To increase the capacity of the shock transmitted to the specimen at that installation (20 cm-edge cube), the shock is generated by the violent release of a tight cable. The device (a Hopkinson Bar Bundle (HBB)) consists of a prismatic Hopkinson bar beam, each bar being instrumented, which transmits the traction wave to the specimen. Potential helical reinforcements at both ends of the specimen are eliminated. It is possible to follow both the opening of a crack across the specimen and the loading transmission remaining in the not yet broken ligament, by applying a simplifying hypothesis of wave propagation and load transmission inside the breaking specimen.

Most of the significant results concerning high-speed traction concrete behavior detailed in section 1.5 were discovered using this installation (Figure 1.9) on quite large scales.

1.3.1.2. *Hopkinson bar Brazilian test*

The test is an expansion of the Brazilian test, whose traditional analysis is based on the assumption of brittle elastic behavior. We consider an elastic cylinder compressed perpendicularly to its generators: compression is applied along two diametric generators. A plane deformation elastic calculation shows that loading causes practically constant traction maximum stress along the cylinder axle, at right angles to the compression axle. We assume cylinder failure takes place when the strain reaches the ultimate value. Carrying out this test in quasi-statics is not obvious, as it requires strict respect for limit conditions and the ideal elastic model (stiff supports among others). Nonetheless, this trial is easy to carry out and gives a consistent order of magnitude for simple traction failure stress.

Extension to the dynamic situation is easy. Compression is applied using a Hopkinson bar. If we want to analyze the results in the standard way, we suppose that the situation is not too far from the quasi-static case. To do this, we have to assume that inertial effects can be neglected. They can be neglected before failure but, as is the case for simple compression, they cause an apparent increase in the maximum load after failure, so consequently it is important to detect failure by direct observation (using high-speed imaging), as it is for dynamic compression tests where localization of strains with block development does not necessarily lead to load drop immediately. We should also check that the mechanical fields are not too far away from the fields we would have in statics at the same applied force value. Thus, we have to verify that failure occurs at a time when input and output forces are quasi-equal. Such a situation will only happen when loading is slower than the homogenizing time (typically the time for the elastic waves to cover the diameter of the sample several times).

Achieving all these conditions simultaneously is difficult, but as we saw in section 1.1.2.2, the Hopkinson bar provides us with information about the loads and displacements applied to the sample all the time. Assuming this data is accurate, we can then carry out a numeric simulation of the test (assuming brittle elastic behavior), which gives a more precise assessment of failure strength [TED 93]. However, this hybrid approach (calculation-test association) is that of a structure trial, and is better suited to model validation than directly determining a behavior parameter.

1.3.1.3. *Scabbing test*

The scabbing test is a test with a fundamentally transient analysis. Actually it is based on analyzing wave propagation inside a bar made of the material itself. Concrete, a brittle material has a uniaxial compression strength that is clearly superior to its traction strength.

By using an assembly like the one in Figure 1.10, we induce a compression wave (propagating to the right in the figure), which is reflected at the free end as a traction wave [BRA 99], [DIA 97].

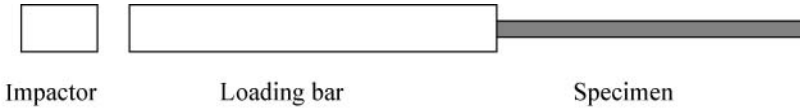

Figure 1.10. *Scabbing test diagram*

The compression pulse produced by the impactor is measured via a strain gauge glued to the bar. The elastic properties of the bar and the sample being known, we can infer the shape of the pulse induced inside the sample. We can also glue a gauge on the specimen to measure it directly. The compression wave thus produced has a lower amplitude stress than the compression concrete failure stress. The opposite amplitude reflected traction wave is sufficient to cause failure in the sample at a specific position. By applying the principle of elastic wave superposition, we can infer the stress value at the failure point. The analysis is easy because the pulse is short compared to the propagation time inside the sample. This is why we use short impactors and long specimens. Making specimens respecting homogeneity conditions is therefore delicate.

The accuracy of the test analysis can be improved by additional information such as the failure instant, which can be obtained by high-speed imaging. In some cases, we can observe successive failures in the sample, analysis of which gives redundant measurements of failure stress.

This trial also gives accurate and reliable measurements of limit conditions, and the loading parameters are well-mastered. Fine interpretation still remains difficult as it is one-dimensional (as far as wave propagation is concerned), whereas failure has to propagate in the transverse direction. Moreover, the characteristic phenomenon is quite local. High strain gradients do not allow easy measurement of the strain rate characteristic of the test. This speed is usually taken as the strain time derivative near the failure point; for a one-dimensional wave, this derivative is proportional to the deformation spatial derivative.

For concrete, a very marked increase of failure stress with strain rate has been observed [BRA 99]. Between 1 and 100 s^{-1} , failure stress can be multiplied by as much as a factor of 10. The physical interpretation of this result still has to be more closely examined.

1.3.2. Tests implementing compression behavior

1.3.2.1. Hopkinson bar trial

As explained in section 1.1.2.2, the Hopkinson bar allows an accurate measurement of the forces and displacements applied on a both faces of a sample, especially in compression. Particular precautions pointed out give access to the weak strain area in the case of concrete. Figure 1.11 shows an example of the forces measured on each face, as well as the rates applied to each face of the sample (Figure 1.12) and the associated displacements (Figure 1.13).

For this test, the specimen is initially 40 mm in both length and diameter. Its relative density is 2.25 kg/m^3 , with a largest aggregate diameter of 8 mm. It is loaded via an aluminum Hopkinson bar, 40 mm in diameter. The 1.3 m long impactor is projected with a speed of 14.5 m/s. When observing the speeds to be measured, we notice that the specimen absorbs little of the available energy, since the loading bar speed is roughly equal to the initial speed of the impactor at the end of the test, i.e. when the sample has failed. The induced displacements are very low, as the displacement associated with the force peaks is below 1 mm. The post-peak phase observed on the loads says a lot about the existence of inertial confinement.

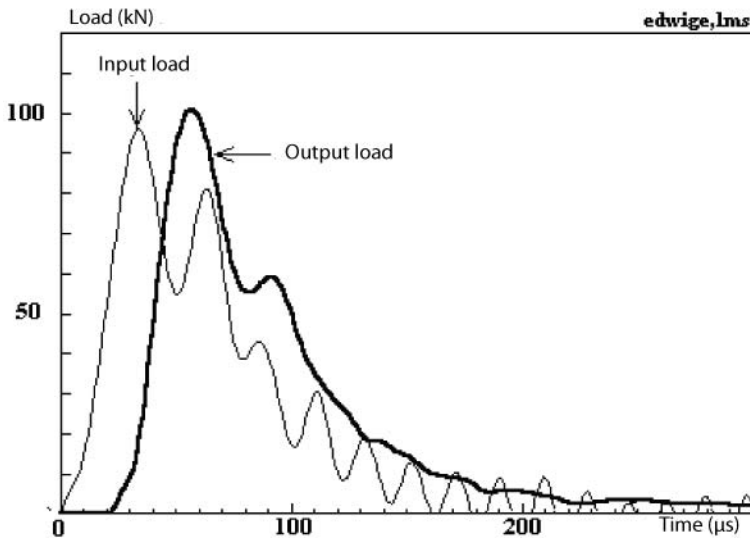

Figure 1.11. Hopkinson bar compression test input and output loads

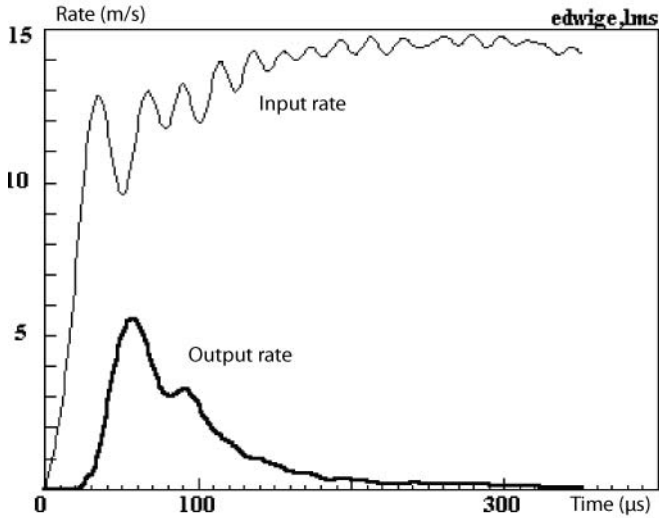

Figure 1.12. *Hopkinson bar compression test input and output rates*

A one-dimensional transient elastic calculation simulates the test quite well. The incident wave being known, we calculate the reflected and transmitted waves during the first 45 μs , after which the result of the calculation suddenly deviates from the measurements. From this, we can infer that failure takes place after 45 μs at the latest. This instant is more or less synchronous with the output load peak. For this calculation, the apparent elastic modulus is 7.8 GPa. This “modulus” is quite weak and can probably be explained by concentrated strains at the interfaces between the specimen and bar surfaces: these cannot be neglected in statics either when considering the specific strains on a specimen. If we only consider this phase of the trial, we notice a time shift between the maximum of the load, equal to about half the 45 μs .

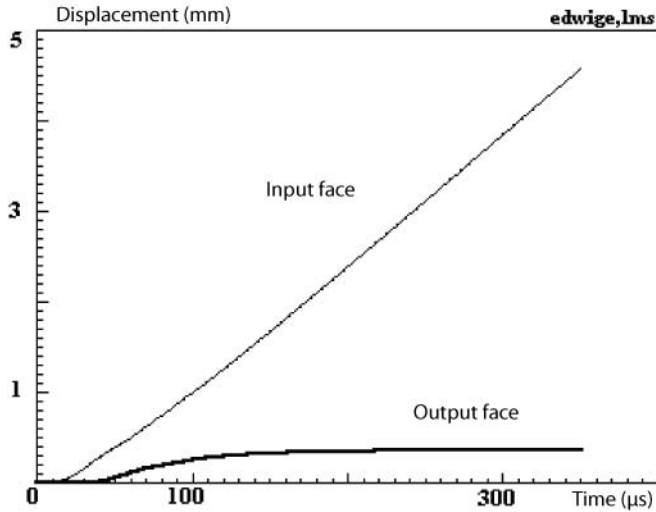

Figure 1.13. Hopkinson bar compression test. Displacement at input and output faces

These values taken into account, it is certainly not reasonable to suppose the mechanic fields are homogenous and deduce a stress–strain relationship from them. Nevertheless, if this simplified analysis is done to obtain an order of magnitude of the strain associated to the stress peak and corresponding strain rate, we obtain the results shown below (Figure 1.14). Depending on the way the stress is calculated (without homogeneity, there is no reason to consider the average effort more than the output load), the stress peak is reached for an overall “strain” (average relative displacement between the input and output faces) ranging from 0.75% to 1%. In fact, as indicated, failure probably occurred 20 μs before, i.e. maybe for a half as low “strain”, the average strain rate is about 200 m/s without being really accurate.

A transient analysis can be carried out within a one-dimensional frame ([GAR 96], [GAR 98], [ZHA 96]), by using a “simple” negative strain-hardening elasto-visco-plastic model. This approach gives results in accordance with the measurements. However, it is insufficient, because it considers the sample as the material and it does not take into account structure effects or inertial confinement. It makes more sense to use a three-dimensional model and to simulate the test using finite element dynamic calculation. This approach was developed in the GEO network [BAI 99].

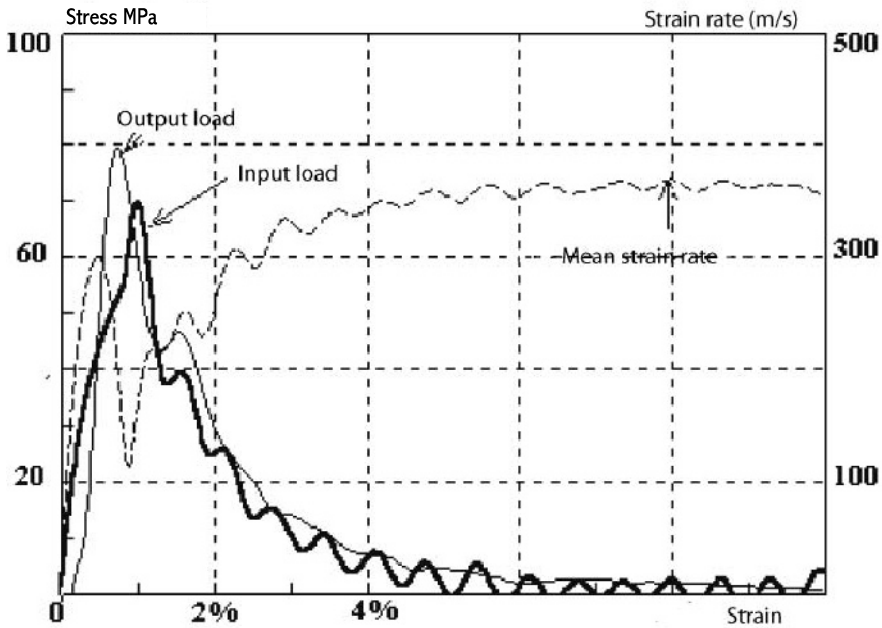

Figure 1.14. *Approximate average behavior*

At last, the same type of trial can be carried out in confinement, using confinement cells coupled to a compression Hopkinson bar system [GAR 98]. It is important to use pressure confinement with gas and a large enough chamber inside. Using an incompressible fluid actually leads to interference confinement, because it acts as a strain limiter. Typical results [GAR 98] show that the confinement effect is the same kind as the strain speed effect to which it is added. Therefore, we can infer that the main effect of strain rate in a concrete dynamic compression test is a structure effect linked to the inertial confinement. This result was confirmed by digital simulations, which are developed in [BAI 99].

1.3.2.2. *Direct impact tests (shock cannon)*

The Hopkinson bar test gives information on high-speed concrete compression behavior, however the practical limitation of transversal dimensions (less than 10 cm in general) works against good representativity of the concrete material. That is why “block bar” devices that carry out direct impacts on a concrete cylinder have been developed ([BIS 95], [DAR 95]). The impactor is guided and propelled either by direct falling or a compressed-air canon. The quality of the contact between the

impactor and the sample face is essential for a good repartition of loads. In practice, the surface of the impactor and that at the rear of the reaction system can lead to a limitation of the transverse strains at both ends of the specimen, upon which it is necessary to use a specimen with sufficient slenderness (2 or more). If an efficient anti-helical reinforcement system is used, we observe prismatic failure corresponding to the cutting of angular sectors [MUR 86].

The rates reached are important, ranging from 1 to 100 s⁻¹. The strains can only be measured by extensometer gages glued to the sample. An artifact is possible due to confinement, which is different at the heart and at the periphery of the specimen. Measuring the loads also requires particular precautions, considering the inertia of the impactor. It is generally inaccurate to consider the acceleration measurement on the impactor. Bischoff and Perry developed an ultra-flat pressure cell to minimize the reflections of waves therein, the cell being inserted between the specimen and the assumed motionless reaction body at the back of the specimen.

The results obtained with these devices (mainly the maximum average stress reached) are along the same lines as those obtained on Hopkinson bars. Guidance defects (centering loads) and surface evenness (contact hard spots) could be the cause of dislocations when the results are in a continuity with those obtained with presses. Besides which, the immobility of the reaction device has to be verified, otherwise a correction for inertia becomes necessary. Anyway, at the speeds reached, the direct transformation of the maximum effort recorded into “failure stress” can only be considered as conventional, as the analysis reveals inertial effects and the “inhomogenous” divergent feature of the axial and radial stresses inside the specimen.

1.4. Other tests

1.4.1. *Tests adaptable to an energetic approach*

In all that has been said so far, we have noted the difficulties linked to finely identifying the high-speed dynamic properties of concrete. Considering these experimental difficulties, and the necessity to identify calculation parameters simple enough for engineers, some means have been developed to enhance – in a comparative way – the energy absorption properties of some concretes (especially fiber reinforced concrete). Basically the approach involves adapting the resilience test, which is standard for metals, to concrete, and which corresponds to a dynamic bending loading, the load being applied via a pendulum ram impact testing machine (Charpy test).

Interpreting the test relies on the fact that the drop energy (potential energy of the pendulum, turned into kinetic energy) is partially transmitted to the specimen as strain energy, and can even be completely consumed in the event of the specimen failing without resilience of the ram. Depending on the type of impacted sample (prism slotted or not), the failure energy determined in this way is incorporated in the hypothesis of a brittle-elastic behavior, by determining either a bending traction strength, the “global” energy of the failure per unit area, or an energy restitution critical rate. Employing the result of the “pre-dimensioning” test involves determining (by calibrating in comparison to thickness of well-known materials) a material thickness as a function of the shock energy to be absorbed, in applications where the concrete wall has to withstand bending impacts. Whatever the case, if this type of test allows a comparative analysis, it can be subject to artifacts, due to the energy dissipation sources which are not taken into account (movement of supports, frame and sample, local dissipation at the impact spot, local deterioration of the concrete and heating). The respective masses of the specimen, pendulum and frame are such that the inertia of the test body can rarely be neglected in shock.

However, the use of a pendulum system is based on a good control of the initially transmitted energy, which is why a traction device adapted from a pendulum has been developed ([BAN 91], [BAN 96]) so as to carry out traction or pull-out tests on fiber-reinforced concrete. The strain rate reached with this type of device is about 0.1 s^{-1} . The load measurements carried out are difficult to interpret, as the presence of the sample acts as a divergence from a no-load measurement. A significant part of the energy seems to be dissipated by frame vibrations.

1.4.2. Validation tests on structures requiring an inverse analysis

1.4.2.1. Falling mass tests

Generating shocks using falling mass devices, for example with pendulum systems, is a relatively simple and economical solution to produce high-speed loadings on concrete test-bodies, which is also useful in typical loadings, where concrete distortions on plates essentially operate in bending. These are no longer behavior identification tests of a material, but tests of representative structure components. These devices have been widely used ([KRA 93], [KRA 96], [MIN 87]). One advantage – theoretically at least – is that it enables a “static” test with similar limit conditions and loading application geometry to be carried out.

Nevertheless, correctly interpreting this kind of test requires a careful inverse analysis, if we want to identify details of the dynamic behavior of the concrete material (possibility of parametric studies with varying properties of the constituent materials) or of the reinforcement [DAN 01]. Actually the generally sought

operation is a bending mechanism, though with some inherent complexities [KRA 93]. We need to consider:

- operation as a slab which cannot be reduced to a beam operation;
- plate operation (diaphragm effect);
- possible local mechanisms depending on the shock range and energy (local crush, punching or transverse load failure on the supports);
- sensitivity to the support conditions (problem linked to the dynamic unilateral support conditions);
- problems linked to the resilience of the impactor;
- sensitivity of the failure mode to singularities (corner effects).

As an example of the extra information that can emerge if the above points are considered, an important sensitivity of such tests' overall results to the “nose-shaped” impactor [BIN 01] has been shown, with a part of the impact energy being consumed when starting a penetration mechanism [WAT 02]. When a complete inverse analysis can be conducted, notably with well controlled loading and limit conditions, the competition between the different damage and collapse mechanisms can be highlighted according to the impact speed, which was especially the case for reinforced concrete walls submitted to the impact of a pendulum in [MIY 91a] and [MIY 91b].

As regards validating complex systems [SAT 95a] comprising a concrete structure (reinforced or pre-stressed) and/or supports interacting with the ground, tests where impact is achieved by means of a falling mass are often used [PER 01], the ability to control and modulate the incident energy (blocks ranging from a few tens to several hundreds of kilos, falling heights up to 30 m – limitations due to the sizes of cranes) must be taken into account. Re-calculating the test is often difficult because of the frequent presence of dissipative materials (ground, granular materials, energy dampers). Research into systematic empirical interpretations worthy of note (especially with a view to dimensioning rock fall devices to protect transport infrastructures) includes [LAB 96], [MIK 95], [MON 98] and [SAT 95b].

1.4.2.2. *Block fall tests*

If we want to collect exploitable information about the participation of the different materials and components in the overall strength, tests on structure elements require an inverse analysis, which is often complex in dynamics. However, in so far as the load and the test body are close to the “real” situation, some tests are used directly, to confirm and/or compare various technical solutions. In a manner complementary to block-falling tests, tests where the concrete element itself is

submitted to a shock are used. This is especially the case when validating radioactive waste containers ([LAE 94], [VEC 88]). In order to anticipate the result of this kind of test, simplified analysis methods have been developed ([MAR 87], [SER 98a]), and these allow parametric study when designing and developing prototypes. This experimental configuration allows good control of energy during the shock, and confirmation of the hypothesis when the impacted area is motionless and dimensionally stable. On the other hand, fitting structures with the required instruments for this is generally expensive and difficult (on-board accelerometers); consequently, identifying the analysis should be based on a *a posteriori* observable cracking state.

1.4.2.3. *Explosion resistance test*

For a number of protection structures, overall dynamic loading is more significant than a local impact. Adapted large-scale experimentation is carried out via pressure loading caused by an explosion. Control of such loading and its similarity rules is rather good, subject to limit conditions and simple structure geometry, which limits uncertainties linked to reflections. In this kind of experiment, instrumentation can be quite complex (numerous pressure sensors, gauges, displacement sensors and accelerometers). The most important factors are the data acquisition speed, and the qualities of activation and filtering. Many experiments have been carried out on typical structures, including structural walls and slabs ([GRO 90], [KR 96]), vaults and tunnels [KRA 89] and hot caves. Controlling the mechanical limit conditions is the main difficulty for obtaining a precise inverse analysis in such cases; therefore, this kind of test is often used for validating simplified regulations and abacuses for the dimensioning of protection structures.

Another category of tests carried out using blasting charges is aimed at characterizing the “compaction” behavior of a material, the latter being closest to the blasting charge in a highly confined stress state due to the pressure resulting from the explosion nearby on the one hand, and to the rest of the surrounding structure not yet hit by the loading wave. Such tests are transient, and the analysis requires recalculation (made easier by the semi-spherical symmetry of the problem). The data is generally adapted to a volume-pressure limit curve interpretation, characteristic of the areas submitted to strong tri-axial compressions. A recent description and interpretation of such tests can be found in the works of the GEO network [BAI 99].

1.5. Synthesis of the experimental data on concrete and associated materials

1.5.1. Data on cement paste mortar and concrete

1.5.1.1. Looking for a consistent interpretation

When analyzing experimental results, the multiplicity of experimental data, obtained under different stress conditions, and the difficulty in interpreting them with frequent necessary re-calculation and transient analysis, coupled with the variety of observation scales used makes a clear presentation of the characteristics of concrete's dynamic behavior rather difficult.

We propose an interpretation based on Rossi's initial ideas [ROS 91], highlighted by many experimental programmes, the validity range of which is being discussed. The underlying idea is essentially linked to the fact that cement materials that have had evaporable water removed do not show any evolution of strength when stressed at rates ranging from 10^{-6} to 10 s^{-1} [TOU 95a]. This fact has been verified on mortar and concrete, in both traction and compression ([DAR 95], [HAR 90], [ROS 92b], [TOU 95a]), within a domain where the quasi-static interpretation of the test results is valid and thus allows a "conventional" interpretation of the behavior of the material.

We can infer from this that the "sensitivity" of the concrete material to stress rate is (within the considered domain) linked to the presence of free water inside the porous material [TOU 99a]. This fact makes the control of its hydration state crucial when its properties are being identified at high speeds, which is rather difficult to implement. Part of the variability of the results observed in literature can be explained by partial drying of specimens ([COW 66], [KAP 80]), in addition to self-stresses linked to drying, which are superimposed to the initial mechanical state of test bodies, the influence of which is all the more important due to their small size.

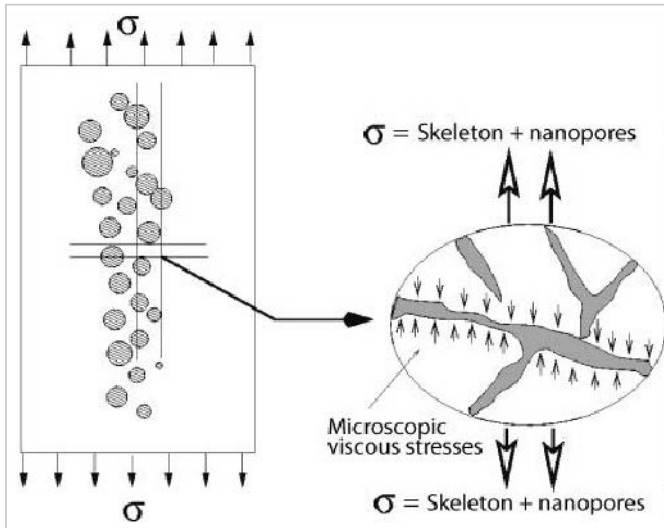

Figure 1.15. *Apparent strength of concrete in traction dynamic loading (from [TOU 95a])*

The free water present in the porous volume is stressed like a viscous fluid by the (fast) motion imposed on the sides of the skeleton, which in the ideal case of a film between two walls is known as the Stefan effect. The consequences of this can be observed in high-speed traction or compression tests as an increase (low relative value) of stiffness, and a more significant increase in the strength, called the rate effect. The macroscopic stress increase can then be interpreted by partition between the stresses borne by the skeleton and viscous stresses borne by the fluid (Figure 1.15). Things progress as if these viscous stresses cause pre-stress in the skeleton and delay either its traction failure or the failure in the extension direction induced by loading when the latter is not purely tri-axial. The partition and its effect on material failure are at the root of the elasto-plastic viscous strain-hardening model developed by Sercombe [SER 98b].

For higher-rate tests (over 1 to 10 s^{-1}), even when the hydration state is well controlled, the transient character of the test and the failure phase of the specimen take precedence over the rate effect linked to the nature of the material, qualitatively at least [WEE 98]. The relative increase in “strength”, compared to the static reference value, can exceed a value of 2, even for specimens in which free water has been eliminated [ROS 96]. In fact, we can notice that a dynamic failure mechanical analysis (which takes critical crack propagation inside a material with non-zero inertia into account) is consistent with the experimental observation, which is that the relative strength increase (dynamic increase factor (DIF)) evolves with the strain

rate in a logarithmic diagram, along a 1/3 slope straight line ([CHA 98], [KIP 80]), beyond a certain threshold (typically 1 to 30 s⁻¹, depending on geometry and loading) which corresponds to the limit beyond which the test has to be analyzed as a transient state ([REI 91], [WEE 89]). An analogous model taking local inertia into account [BAI 94] also justifies the “double state” obtained experimentally if the transient character of the failure is interpreted as a local property.

The latest results obtained on quite large-size concrete samples [CAD 01] are consistent with these two basic mechanisms causing the strength increases observed during high-speed dynamic tests, with the participation and viscosity of water, beyond a specific threshold, and the participation of inertia on both sides of the failure origin.

1.5.1.2. Effect of the structure of the cement paste

The crucial part played by free water in determining the sensitivity of concrete behavior to loading speed in a transient state has led to speculations about the relevance of conventional parameters used to describe the dependence. Actually, it appeared that the conventional definitions ([COL 88], [BIS 91], [MAL 98]) of compression or traction DIFs, as well as those of ultimate strain or Young’s modulus, have led to values varying according to the static properties of concrete, including compression strength ([COL 88], [JAW 87], [ROS 95]). This is apparently responsible for the wide discrepancies in the diagrams used to describe strength evolution (Figures 1.16 and 1.17), and interferes with them being taken easily and reliably into account in a regulation context.

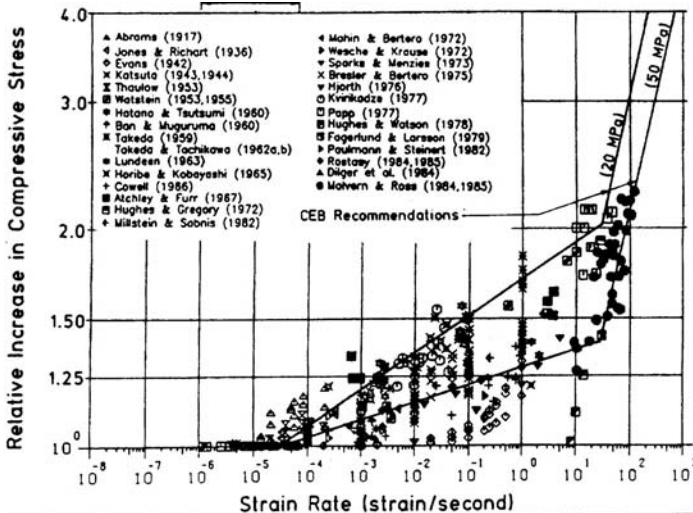

Figure 1.16. Concrete compression strength. “Rate effects” (from [BIS 91])

If, as a first approximation, we assert that in the rate domain (where inertial effects can be neglected), absolute traction strength increases observed in concretes of various strengths (35 to 120 MPa [TOU 95a] and 230 MPa for tests on high efficiency concretes [TOU 99b]) are not a function of the strength (Figure 1.18), with a careful identification of the specimens to avoid hydration gradients, we have proposed that this characteristic should be used [TOU 99a], rather than the relative increase [ROS 95]. A reasonable order of magnitude is obtained with a rounded down value of $+0.7 \text{ MPa}/\log_{10}$ (loading rate in MPa/s) to represent the increase in strength, for a common or high-efficiency concrete. In the same way, a $+0.9 \text{ GPa}/\log_{10}$ increase of the Young's modulus (loading rate in MPa/s) can be adopted as a first approximation. From these values, using classical hypotheses about concrete behavior in other stress states, we obtain a reasonable order of magnitude for the compression strength increase (about $+6 \text{ MPa}/\log_{10}$ with loading rate in MPa/s).

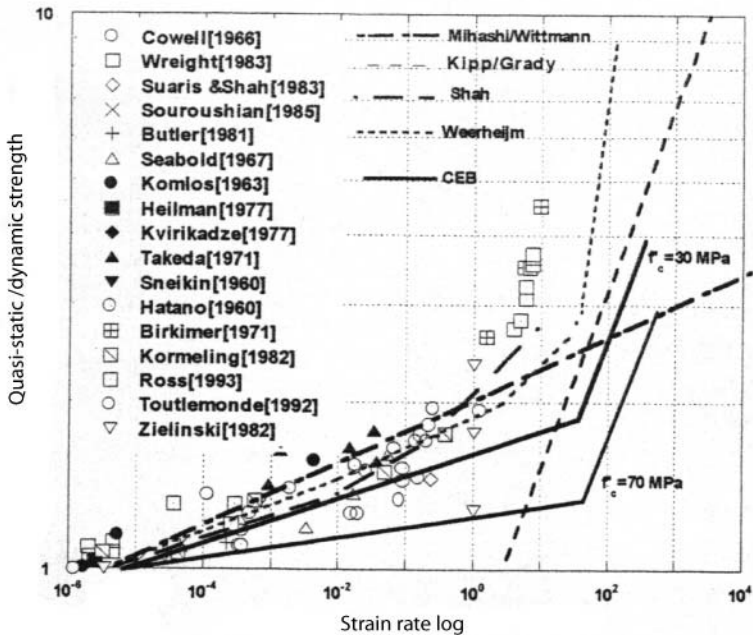

Figure 1.17. Concrete traction strength. “Rate effects” (from [BRA 99])

More accurate identification of the really influential parameters has been obtained from data for which the amount of hardened cement paste, the size of the biggest aggregates and the water/cement ratio (control of micrometric porosity) were used as the main variables of the experiment surface. The fact that the whole amount

of hydrated calcium silicate (CSH) and the relative compactness of the aggregated skeleton [LAR 00] (a characteristic value of the part of the cement paste and its defects with regard to the part of the defects due to the paste-aggregate interfaces and the compactness defects of the skeleton) could constitute two significant factors to improve the accuracy of the description of rate effects as a function of the composition of concrete has been brought about [TOU 95a]. Within the limit where the strength is not first controlled by various defects, the sensitivity of the strength of the material at loading speed is mostly controlled by the amount of free water present in the nanopores of the material, which are intrinsic to the porosity of hydrates and become saturated when the outside relative humidity exceeds 50%.

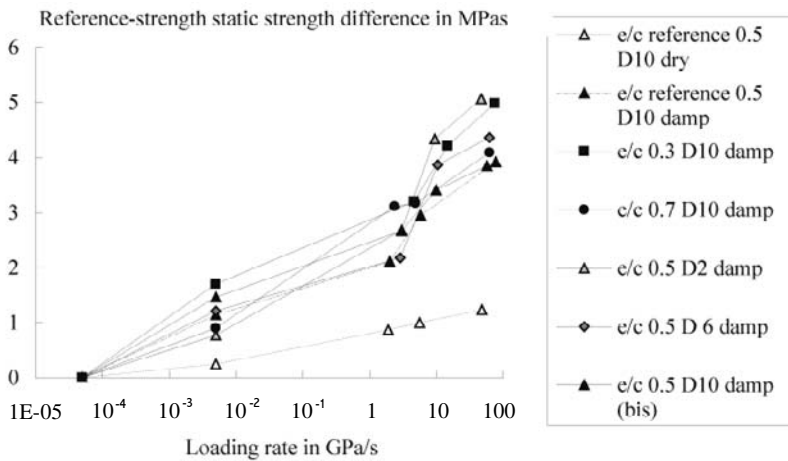

Figure 1.18. Traction strength variation according to loading rate (from [TOU 95a])

1.5.1.3. Description of a plasticity criterion in terms of evolution

The previous description from monotonous testing is based on the evolution of the maximum load applied to the specimen. For the purposes of dimensioning by extrapolation from static calculations, on verifying the section strength or the ultimate time, concrete dynamic strength (especially in compression for reinforced concrete pieces) is the main problem, and the ultimate time can be used to calibrate the oscillator that corresponds to the structure element under consideration, according to several codes or recommendations ([COL 88], [COL 86]). With such an approach, the DIF concept becomes interesting, despite the fact that the value obtained is linked, amongst other things, to the considered concrete and the stress rate.

For more comprehensive calculations, strength evolution is insufficient, as the strain speed value is not constant and cannot define the behavior characteristics alone. In addition, strain data during characterization experiments (modulus, limit strains) are not abundant and are sometimes contradictory because of difficulties with measurements and interpretations (like localization, the effects of which have been described when mobilizing inner inertial loads), as shown by [COL 88], [BIS 91] and [SER 98a].

A “unified” use of results published in the literature can lead to a description of the dynamic behavior of the material through the “evolution” of its static behavior. The advantage of this approach is that it covers *a priori* (using a conventional three-dimensional interpretation) all possible stress states, whilst also taking advantage of the (rather rare) validations of criteria in strongly tri-axial stress domains. However, from this perspective, using viscoplasticity or damage models with “standard” gradients has limitations, because experimental data coincide rather badly with the calibration of viscosity aimed at mastering numerical regularity problems ([GEO 98], [TOU 95b]).

This is why it has been necessary to explore more complex modeling by extension of a damageable elasto-plastic model, thanks to a strain-hardening variable with the same nature as a viscous strain [SER 98B]. This inner variable corresponds to an extension strain (Figure 1.19), in so far as the rate effects are principally linked to the deviatoric component of the stress state, the intervention of confinement delaying localization of failure in the potential growth direction, the same as in statics [KON 01]. The methodology for identifying the parameters of the model from a relatively low number of well controlled empirical data points (direct traction tests at various rates) have been detailed and validated by traction simulations, compression and shear tests on specimens, and bending tests on slabs [SER 98b]. These simulations have allowed it to be validated within the studied domain, for testing hypotheses about the kinematic nature of viscous strain hardening (Figure 1.20). The validation of such an approach should be continued using high-confinement tests ([GON 90], [GRA 89], [MAL 91]). As for the problem of falling containers, which was used as a basis for this development, the importance of the various sophistications of the model (damaging, taking viscous strain-hardening into account) was verified by a sensitivity study, which essentially showed the behavior of the studied structure was governed by both local compression of concrete at the impact point and propagation of induced tractions within part of the structure where confinement was weak [SER 98a].

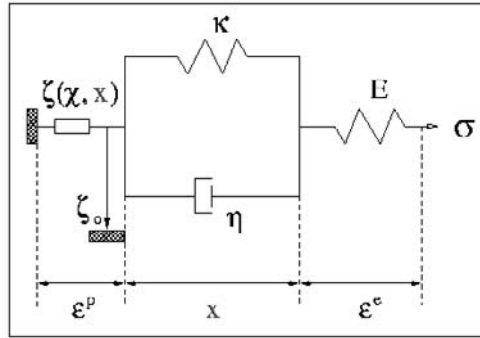

Figure 1.19. Visco-elasto-plastic model with viscous strain hardening [SER 98a]. In this 1D diagram, the total strain ϵ is the sum of the 3 scalar terms ϵ^p , x and ϵ^e

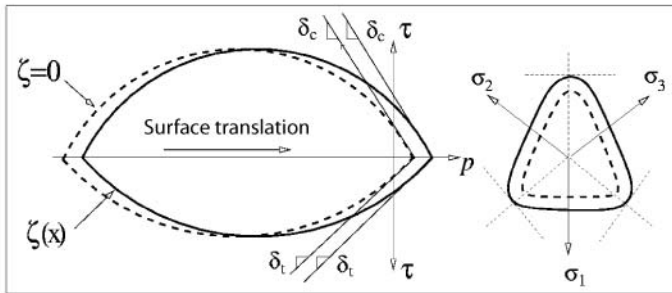

Figure 1.20. Visco-elasto-plastic model with viscous strain hardening [SER 98a]. The plasticity criterion is translated into viscous strain hardening

Note that such modeling is below the localization of strains integrated into the local description of the behavior. For the purpose of the study behind the development of the model [TOU 99b], this limit seemed acceptable because calculating the structure was not supposed to reveal any fracturing, and the calculated strain rates appeared to be limited to about 1 s^{-1} .

For justifications based on “ultimate limit state” calculations including possible localization of strains in part of the structure, the question of integrating inertial effects into the local behavior description can be raised [MAL 98]. We have to be aware of the theoretical difficulties caused by taking non-linearities into account,

and difficulties in ensuring validation on the scale of the structure, as it has already been enhanced during test interpretation.

1.5.2. Data available for reinforced concrete

1.5.2.1. Dynamic behavior of reinforcements

To design structures, the dynamic characteristics of the steel framework are as crucial as those of concrete; indeed, the ductile character of a failure due to accidental dynamic strain can be investigated, owing to failure due to R-bars. Technical data concerning high-speed behavior of reinforced concrete framework proved to be rare, and information about pre-stressed frameworks was non-existent. A recent synthesis is available in [MAL 97]. The results are exploited to determine a relative increase in traction strength (DIF) or elastic limit. Owing to the idealization of framework behavior that is general in calculations and to the fact that no elasticity modulus variation seems to be revealed at the strain rates considered, rate effects on the elastic limit and strength are sufficient to ensure that a consistent behavior description is obtained using standard calculation methods for reinforced concrete sections.

The expression proposed by Malvar for describing the relative increase in steel strength as a power of the strain rate (value imposed in the monotonic identification tests) is consistent with the usual descriptions given for concrete ([MAL 98] for example). For about 1/s, relative increases ranging from 10 to 50% of the elastic limit can be expected, depending on the nature of the steel considered. Taking into account the mainly one-dimensional feature of strain in frameworks, it must be possible to directly calibrate a strain-hardening elasto-plastic model for frameworks from this data – with the physical meaning of the variable driving the increase of strength still to be determined.

1.5.2.2. Identification of steel-concrete adherence in dynamics

The R-bar-concrete adherence enables us to consider the strains of the surrounding framework and concrete as identical, and is at the root of the operation and calculation of reinforced concrete structures. The permanence of this property in dynamics and the evolution of limit shear stress are basic questions; however, experimental identification of adherence properties is relatively complex, because measuring techniques used at the interface disrupt the phenomenon itself. In practice, most of the sliding strength of reinforcement is provided by setting locks on concrete, which disconnect when traction strength is reached in the transverse direction. Adherence can then be considered to be directly linked to concrete traction strength, as stipulated in most calculation regulations. Nevertheless, transverse

confinement, which delays disconnection of the rods and activates their gearing with each other, also has a significant influence [MAL 92].

In a reinforcement dynamic pull-out strain, we can expect some inertial confinement to be brought about because the concrete around the reinforcement is in traction, and traction strength increases activation. A description of the evolution of adherence limit shear with regard to speed, which uses a DIF with the same form as the equivalent coefficient for traction strength, has therefore been proposed [VOS 82]. It is based on pull-out tests carried out for an assembly using the Delft modified Hopkinson bar [REI 82]. We note that for smooth steel, the adherence increase is not significant, which confirms the proposed mechanisms.

1.5.2.3. *Repeated stresses*

The behavior of specimens submitted to repeated dynamic stresses is difficult to access experimentally, especially when it is important to achieve significant damage from the first impact. In practice, this information seems to be important if the dynamic situation is not only considered as a fortuitous action, but as likely to be subject to “replicas” (successive shocks between structure elements during earthquakes, for example) or even as a servicing action (which could be the case with rock fall protection works). As for behavior in traction repeated dynamic stresses, it appears from [REI 82] that the “rate effect” displayed is reduced in comparison to the DIF obtained for a single shock. However, the accumulation of traction cycles would cause an apparent reduction of strength that could be of the same order, even at low speeds. As regards numerous indeterminate repeated shocks, avoiding crack propagation once they have started seems out of the question. This leads us to rely on the cracking limit obtained in statics where we have to guarantee the structure must not be cracked; otherwise calculations have to take probable concrete cracking into account.

The main problem with repeated dynamic stresses concerns the operation of the R-bar framework, especially if the action causes a variation of R-bar stress sign. Without confinement, the effect of limit shear during a shock causes concrete damage around the reinforcement according to orientation, and the effect of alternating vibrations or additional shocks can keep on damaging the surrounding concrete fast and irremediably, which reduces adherence and damages the anchorage of the reinforcement. Therefore, it is advisable to cautiously take into account the “adherence increase” due to rate effects, and to associate them with constructive arrangements that will enable them to stay effective – transverse confinement, for instance.

Implementing such arrangements has particular relevance for earthquake resistance fields. Because of identification difficulties at a local level, it is often

necessary to resort to experiments on structure components (see [PAU 02] and [TOR 88]). In fact, at this level it is possible to underline the effectiveness of transverse reinforcement, thereby ensuring the confinement of concrete beyond cracking, allowing loads to travel after redistribution via the creation of “joints”. The amount of experimental work in this field and its complexity will not be dealt with here.

It should be noted that the difficulties arise not because of the dynamic character of stresses (some Hz frequencies with regard to the specific frequencies of the elements – in the 100 Hz order of magnitude) or the dynamic reaction of the material. The difficulties are linked to the intense and repeated feature of stresses (incursions into the plastic field, stiffness damage, crack spreading), and even to the interaction between the loading frequency and the specific frequency of the whole structure (whether sound or progressively damaged).

1.5.3. Data about fiber-reinforced concretes

1.5.3.1. Post-cracking mechanisms and “rate effects”

Thanks to metallic fibers, the favorable influence of diffused reinforcement in dissipating energy during a shock has been empirically proven [ROS 98], but is difficult to quantify. The sensitivity to peeling caused by shocks during transport of some prefabricated fiber reinforced concrete pieces, compared to corresponding concrete or reinforced concrete pieces is admitted by professionals. Using fiber reinforced concrete for particular applications where absorption of energy is important has been shown to be interesting with regard to conventional reinforced solutions [HAN 92]. Most of the time it was proved globally through experiments allowing interpretations in terms of energy. However, complete and documented experimental data on the dynamic behavior of such materials in traction for characterizing after-peak behavior and revealing the contribution of fibers [ROS 98] are quite rare.

The existing data [KÖR 88, TOU 99b] highlight major aspects of the rates of behaviors of these materials: the increase in the linearity limit corresponding to matrix traction strength, a phenomenon which can be directly compared to rate effect of all cement materials in direct traction; also, a stress increase in the after-peak phase (with regard to the load obtained in statics during this phase), the increase being all the less important as a widespread range of crack openings is considered. In other words, the relative increase of the absorbed energy and its peak value is lower than the relative strength increase of the matrix, and it is even weaker if we take crack openings into account.

Such observations are consistent with the rate effect being a function of the cement phase only. Before cracking occurs, fibers have no influence, and the linearity-limit increase (matrix cracking) is similar to that observed in a non-fiber reinforced concrete. After cracking however, the anchoring provided by fibers on both sides of the crack assists in the maintenance of strength. As for reinforcement anchoring, the strength of concrete mini-connecting rods confined by the presence of the other fibers shows a rate effect, as the anchorage is limited by the strength of the concrete around the fibers. Moreover, the wider the crack opening, the more micro-cracked the concrete where anchoring has to take place will be, which limits the effect of the viscous mechanisms underlying the strength increase.

A beneficial “synergy” could be observed by comparing the shock strength of reinforced and fiber reinforced concrete pieces to those of fibered or reinforced pieces. Considering the limited crack openings permitted by fibers for a given load, once cracking has started, some confinement seems possible around the reinforcements, which is not the case for reinforced concrete where adherence has been damaged because of alternating dynamic stresses.

1.5.3.2. Anisotropy and its consequences

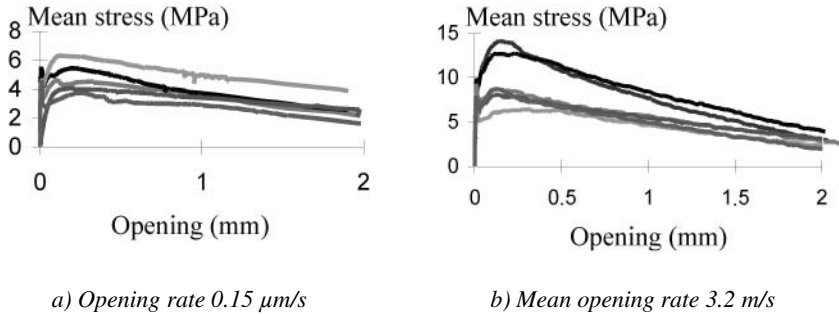
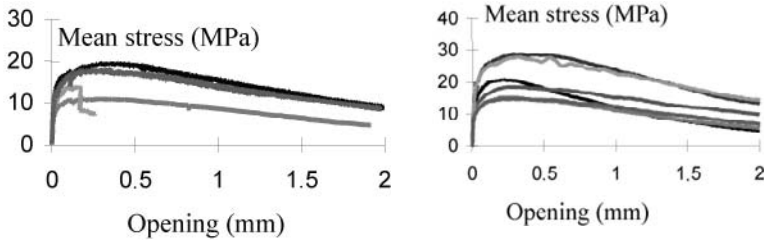

Figure 1.21a and b. Direct traction characterization tests on very high performance concrete, at low and high rates, on pre-slotted specimens. Direction A specimens. Low efficiency of the fibers (from [TOU 99b])



a) Opening rate 0.15 $\mu\text{m/s}$

b) Mean opening rate 2.8 m/s

Figure 1.22a and b. Direct traction characterization tests on very high performance concrete, at low and high rate, on pre-slotted specimens. Direction C specimens. High efficiency of the fibers (from [TOU 99b])

	Quasi-static reference value (0.05 MPa/s) in MPa	Variation with speed in MPa/u. log.
Traction strength	8	+ 0.8
eq. 1 mm threshold stress	7	+ 0.5
Young's modulus	52,000	env. + 450

Table 1.1. Calculation characteristics for very high performance concrete containers, derived from the traction characterization ("rounded off" values used for calculation) (from [TOU 99b])

Value	Direction	Quasi-static value (interpolation for 0.05 MPa/s) and standard deviation	Trend of evolution with rate
Young's modulus			
	A	50.9 GPa (2 GPa)	+ 0.32 GPa/u.log.
	C	53.9 GPa (2.5 GPa)	+ 0.38 GPa/u.log.
	A + B + C	52.2 GPa	+ 0.31 GPa/u.log.
Maximum stress (unslotted specimens)			
	A	5.96 MPa (2 MPa)	+ 0.82 MPa/u. log.
	C	11.17 MPa (3 MPa)	+ 0.77 MPa/u. log.
	A + B + C	8.52 MPa	+ 0.65 MPa/u. log.
Maximum stress (slotted specimens)			
	A	4.29 MPa (2 MPa)	+ 0.70 MPa/u. log.
	C	16.35 MPa (5 MPa)	+ 0.73 MPa/u. log.
	A + B + C	9.65 MPa	+ 0.40 MPa/u. log.
Equivalent threshold stress (1 mm opening)			
	A	3.75 MPa (1.6 MPa)	+ 0.53 MPa/u. log.
	C	13.99 MPa (3.8 MPa)	+ 0.62 MPa/u. log.
	A + B + C	8.06 MPa	+ 0.45 MPa/u. log.

Table 1.2. *Traction characterization of very high performance concrete and rate effects. Results (means): A, B and C are the three perpendicular directions of the sampling within an L piece deemed representative for the project (from [TOU 99b])*

Let us recall that observing the mechanisms referred to above and obtaining characteristic properties suited for the calculation of fiber reinforced concrete structures demands respect for the strict regulations concerning possible anisotropies in the behavior and constitution of the material, which may arise due to the manufacturing mode of the structure [ROS 98]. It was thus possible to enhance (Figures 1.21 and 1.22) rate effects (strength absolute increase), according to the

traction maximum stress or equivalent plastic stress absolute increase, which are comparable as they are linked to the cement matrix for the different directions considered in a fiber concrete piece.

Nevertheless, the absolute values of these strengths and stresses proved to be widely different according to the direction (Tables 1.1 and 1.2), due to preferential orientating of fibers during manufacturing [TOU 99b]. Therefore, the problem of a potential taking into account of the anisotropy as far as fiber-reinforced structure modeling is concerned remains in dynamics as well as in statics. The questions related to the dispersion of properties are also the same.

1.6. Conclusion

The accumulated knowledge available for understanding and describing the high-speed behavior of concrete material remains at a complex overall stage and leaves both the structural engineer and the mechanic dissatisfied. This can be explained by several factors: experimental difficulties in accessing the intrinsic behavior of materials in dynamics tests, difficulties linked to the heterogeneity range of the concrete “material”, its sensitivity to the water environment, its brittleness as a geomaterial which involves crack propagation effects within the specimens, and the wide range of materials actually corresponding to the generic term “concrete”. Besides this, we also have to note that part of the difficulties reflecting on mechanical modeling problems are also present in the usual quasi-static field, even if a standardized corpus valid for engineering common needs often avoids having to ask too many questions.

After recalling the different experimental techniques that allow us to explore concrete dynamic behavior, and after taking a few precautions, we described the main established facts, i.e. the noticeable increase in strength and slight apparent increase in the Young’s modulus, which can be explained by the viscosity of the interstitial water present inside the nanopores (the finest pores within the cement hydrates). This viscous inner phenomenon is inherent to porous solids, and can be observed separately in direct traction tests over a standard range from 10^{-6} to 1 s^{-1} . It also explains the rate effects induced in other stresses (compression, adherence, fiber concrete behavior) reasonably well. At higher rates, interpreting the tests involves a transient analysis of the loading and failure phases of the specimen, as inertial phenomena (in terms of measured loads) that oppose critical crack propagation become predominant.

Different empirical description levels of the mechanisms have been developed, together with the underlying theoretical support and its potential limits: the DIF, which can vary widely depending on the rate and strength of concrete, absolute

traction strength increase, which enables us to calibrate a visco-elasto-plastic model with viscous strain-hardening, and application of dynamic failure mechanics when high-rate failure propagation is at stake. The choice of the behavior description level seems to be consistent with a clear choice of other modeling hypotheses: speed range of the considered strains, unique or repeated characteristic of the dynamic stress, presence or absence of uniaxial behavior, presence or absence of reinforcements, possibility or impossibility of limiting the justification validity in a domain where concrete can still be considered as continuous, etc. Depending on the circumstances, we will naturally turn to a different description level with a more or less important integration of chance in the properties of the material.

After taking these considerations into account, as well as considerations dealing with dimensioning an important number of structures and increasingly considering fortuitous situations ([PER 01], [TRO 01]), we underlined a few shortcomings. First we have seen how difficult it is to access the material under high tri-axial stress. However, it is a crucial problem for direct impacts, areas close to an explosive charge or in cases of potential penetration. As for validating “viscous strain-hardening” hypotheses, and in order to better model the combined effects of inertial confinement [UNO 02], more complete information in the field would be quite helpful as well.

While understanding the mechanisms in the case of a single dynamic stress can be considered as correct and reliable for calculations, the problem of repeated impacts remains difficult, both for validating the potential progressive damage predictions models are likely to supply, and accurately taking into account the evolution of adherence for reinforced concrete structures. This field seems to represent very important stakes for engineers, in the frequent cases of fortuitous dynamic stresses.

Finally, the increasing range of materials coming under the definition of “concrete”, including fiber reinforced concretes, high and very high-performance concretes and ultra-efficient fiber-cement composites will demand more diversified validation of the indications and mechanisms highlighted in this synthesis.

1.7. Bibliography

[ALE 94] ALEXANDRE M., “Etablissement du cahier des charges d’un conteneur de haute intégrité pour l’entreposage de longue durée des déchets B en vrac”, *Rapport de la commission pour les questions scientifiques et techniques relatives à la gestion des déchets radioactifs auprès du conseil scientifique du CEA*, March 1994.

- [BAI 87] BAILLY P., BROSSARD J., DESROSIER C., RENARD J., “Approche expérimentale du comportement et des caractéristiques dynamiques des mortiers armés de fibres”, *Cinquièmes journées universitaires de Génie Civil*, Bordeaux, 1987.
- [BAI 88] BAILLY P., Effets des explosions sur les constructions. Chargement et réponse de la structure, Thesis, University of Orleans, June 1988.
- [BAI 94] BAILLY P., “Une modélisation d’un matériau fragile avec prise en compte d’effets dynamiques”, *C.R. de l’Académie des Sciences de Paris*, Series II, vol. 318, pp. 1–6, 1994.
- [BAI 99] BAILLY P., “Comportement des ouvrages en dynamique rapide”, *Recueil de communications du groupe de travail Géomatériaux Environnement Ouvrages (GEO)*, Aussois, France, 1–3 February 1999 (*Ouvrages et Actions accidentelles* project).
- [BAN 91] BANTHIA N., TROTTIER J.-F., “Deformed steel fiber – cementitious matrix bond under impact”, *Cement and Concrete Research*, Vol. 21, pp. 158–168, 1991.
- [BAN 96] BANTHIA N., MINDESS S., TROTTIER J.-F., “Impact resistance of steel fiber reinforced concrete”, *ACI Materials Journal*, Vol. 93, N° 5, pp. 472–479, 1996.
- [BIN 01] BINDIGANAVILE V., BANTHIA N., “Machine effect in the drop-weight impact testing of plain concrete beams”, *3rd International Conference on Concrete under Severe Conditions: Environment and Loading, CONSEC’01*, Vancouver, BC, Canada, Proceedings Banthia, Sakai and Gjörv (Ed.), E&FN SPON, Vol. I, pp. 589–596, 18–20 June 2001.
- [BIS 91] BISCHOFF P.H., PERRY S.H., “Compressive behavior of concrete at high strain rates”, *Materials and Structures*, 24, pp. 425–450, 1991.
- [BIS 95] BISCHOFF P.H., PERRY S.H., “Impact behavior of plain concrete loaded in uniaxial compression”, *J. of Eng. Mechanics*, Vol. 121, N° 6, pp. 685–693, 1995.
- [BOU 99] BOULAY C., LE MAOU F., RENWEZ S., “Quelques pièges à éviter lors de la détermination de la résistance et du module en compression sur cylindres de béton”, *Bulletin des Laboratoires des Ponts et Chaussées*, N° 220, pp. 63–74, March–April, 1999.
- [BRA 99] BRARA A., Etude expérimentale de la traction dynamique du béton par écaillage, PhD Thesis, University of Metz, 1999.
- [BUS 02] BUSSAC M.N., COLLET P., GARY G., OTHMAN R., “An optimization method for separating and rebuilding one-dimensional dispersive waves from multi-point measurements. Application to elastic or viscoelastic bars”, *J. Mech. Phys. Solids*, Vol. 50, N° 2, pp. 321–350, 2002.
- [CAD 01] CADONI E., ALBERTINI C., LABIBES K., SOLOMOS G., “Behavior of plain concrete subjected to tensile loading at high strain-rate”, in *Fracture Mechanics of Concrete Structures*, de Borst *et al.* (Ed.), Swets & Zeitlinger, Lisse, The Netherlands, pp. 341–347, 2001.
- [CHA 98] CHANDRA D., KRAUTHAMMER T., “Rate-sensitive micro mechanical model for concrete”, in *ACI SP-175 Concrete and Blast effects*, ACI International, W. Bounds (Ed.), paper SP 175-14, pp. 281–305, 1998.

- [COL 86] COLLECTIF, Tm5-1300, *Structures to resist the effects of accidental explosions*, Department of the Army, the Navy and the Air Force, technical manual, NAVFAC P-397, AFM 88-22, 1986.
- [COL 88] COLLECTIF, CEB, “Concrete Structures under impact and impulsive loading”, *Bulletin d’information*, N° 187, Lausanne, Switzerland, 1988.
- [COW 66] COWELL W. L., “Dynamic properties of plain Portland cement concrete”, *Techn. report R447*, DASA 130181, US Naval Civ. Eng. Lab., Port Hueneme, California, 1966.
- [DAN 01] DANCYGIER A.N., YANKELEVSKY D.Z., “The role of concrete in resisting projectile penetration into concrete barriers”, *3rd Int. Conf. on Concrete under Severe Conditions: Environment and Loading, CONSEC’01*, Vancouver, BC, Canada, Proc. by Banthia, Sakai and GjØrv (Ed.), E & FN SPON, Vol. I, pp. 612–619, 18–20 June, 2001.
- [DAR 95] DARVE F., HICHER P.Y., REYNOUARD J.M., *Les géomatériaux* (3 volumes), Hermès Science Publications, Paris, 1995 (particularly Vol. 1 Ch. 1, 5, 3; Vol. 2 Chs. 1 and 4, Vol. 3 Paragraphs 2.2.2, by Bailly, Gary, Klepaczko, Hamelin, Rossi, Toutlemonde).
- [DIA 97] DIAMURAYA M., KOBAYASHI H., NONAKA T., “Impact tensile strength and fracture of concrete”, *Journal de Physique IV France 7, Colloque C3* (Supplement of *Journal of Physics III*), pp. 253–258, 1997.
- [GAR 96] GARY G., ZHAO H., “Measurement of the dynamic behavior of concrete under impact loading”, *Proceedings of 2nd ISIE’96*, Beijing, China, *Chinese Journal of Mechanics Press*, Jin, Shi and Ding Editions, pp. 208–213, 1996.
- [GAR 98] GARY G., BAILLY P., “Behavior of a quasi-brittle material at high strain rate. Experiment and modeling”, *European Journal of Mechanics, A/Solids*, 17, N° 3, pp. 403–420, 1998.
- [GAR 99] GARY G., BAILLY P., GATUINGT F., “Testing concrete at high strains and high rates of strain”, *Proc. 3rd Int. Symp. on Impact Eng*, Singapore (December 1998), published in *Impact Response of Materials & Structures*, OUP, pp. 241–246, V.P.W. Shim, S. Tanimura, C.T. Lim (Ed.), National University of Singapore, Singapore, 1999.
- [GEO 98] GEORGIN J.-F., Contribution à la modélisation du béton sous sollicitation de dynamique rapide. La prise en compte de l’effet de vitesse par la viscoplasticité, Thesis, INSA de Lyon, 203 pages, 1998.
- [GON 90] GONG J.C., MALVERN L.E., “Passively confined tests of axial dynamic compressive strength of concrete”, *Experimental Mechanics*, pp. 55–59, 1990.
- [GRA 89] GRAN J.K., FLORENCE A.L., COLTON J.D., “Dynamic tri-axial tests of high-strength concrete”, *J. of Engineering Mechanics*, Vol. 115, N° 5, pp. 891–903, 1989.
- [GRO 90] GROS J.-F., Etude du comportement dynamique de dalles de béton sollicitées par des charges explosives, ENPC, 1990.
- [HAN 92] HANUS F., FAURE J.-C., PEIFFER G., “Béton léger hautes performances – utilisations dans les structures devant résister aux explosions”, in *Les bétons à hautes performances. Caractérisation, durabilité, applications*, Y. Malier (Ed.), Presses de l’ENPC, pp. 651–665, 1992.

- [HAR 90] HARSH S., SHEN Z., DARWIN D., “Strain-rate sensitive behavior of cement paste and mortar in compression”, *ACI Mat. Journal*, Vol. 87 N° 5, pp. 508–516, 1990.
- [HOP 14] HOPKINSON B., “A method of measuring the pressure in the deformation of high explosives by the impact of bullets”, *Phil. Trans. Roy. Soc.*, A213, pp. 437–452, 1914.
- [HOR 87] HORDIJK D.A., REINHARDT H.W., CORNELISSEN H.A.W., “Fracture mechanics parameters of concrete from uniaxial tests as influenced by specimen length”, *Proc. of Int. Conf. on the Fracture of Concrete and Rocks*, Houston, Texas, USA, Shah and Swartz (Ed.), pp. 138–149, 1987.
- [JAW 87] JAWED I. *et al.*, “High strain rate behavior of hydrated cement pastes”, *Cement and Concrete Research*, Vol. 17, pp. 433–440, 1987.
- [KAP 80] KAPLAN S.A., “Factors affecting the relationship between rate of loading and measured compressive strength of concrete”, *Magazine of Concrete Research*, Vol. 32 N° 111, pp. 79–88, 1980.
- [KIP 80] KIPP M.E., GRADY D.E., CHEN E.P., “Strain rate dependent fracture initiation”, *International Journal of Fracture*, Vol. 16 N° 5, pp. 471–478, 1980.
- [KOL 49] KOLSKY H., “An investigation of the mechanical properties of materials at very high rates of loading”, *Proc. Phys. Soc.*, B62, pp. 676–700, 1949.
- [KON 01] KONO S., WATANABE F., KAJITANI A., “Stress-strain relation of confined concrete under dynamic loading”, in *Fracture Mechanics of Concrete Structures*, de Borst *et al.* (Ed.), Swets & Zeitlinger, Lisse, The Netherlands, pp. 585–592, 2001.
- [KÖR 88] KÖRMELING H.A., “Experimental results of plain and steel fiber reinforced concrete under uniaxial impact tensile loading”, Delft University of Technology, The Netherlands, Report 5-84-8, July 1988.
- [KRA 89] KRAUTHAMMER T., FLATHAU W.J., SMITH J.L., BETZ J.F., “Lessons from explosive tests on RC buried arches”, *Journal of Structural Engineering*, Vol. 115 N° 4, pp. 809–825, 1989.
- [KRA 93] KRAUTHAMMER T. (Ed.), *Structural concrete slabs under impulsive loads*, Proceedings of the Workshop held in Trondheim, Norway, Forsvarets Bygningstjeneste Forsøkskontoret, Fortifikatorisk Notat Nr 211/93, 14–16 June 1993.
- [KRA 96] KRAUTHAMMER T., JENSSEN A., LANGSETH M. (Ed.), *Precision testing in support of computer code validation and verification*, Workshop report, Norwegian Defence Construction Service, Fortifikatorisk Notat Nr 234/96, 1996.
- [LAB 96] LABIOUSE V., DESCOEUDRES F., MONTANI S., “Experimental study of rock sheds impacted by rock blocks”, *Structural Engineering International*, IABSE (3), pp. 171–176, 1996.
- [LAR 00] LARRARD F. de, “Structures granulaires et formulation des bétons”, *Etudes et recherches des Laboratoires des Ponts et Chaussées*, OA34, 2000.
- [LOU 94] LOUW J.-M., KOCH B.C., KOEN F.J., “Direct shear strength of concrete under impact”, in *Structures under Shock and Impact III*, Madrid, Spain, 1–3 June, Bulson (Ed.), pp. 147–154, 1994.

- [MAL 91] MALVERN L.E., JENKINDS D.A., TANG T., MAC LURE S., “Dynamic testing of laterally confined concrete”, in *Micromechanics of Failure of Quasi-brittle Materials*, Elsevier Applied Science, pp. 343–352, 1991.
- [MAL 92] MALVAR L.J., “Bond of reinforcement under controlled confinement”, *ACI Materials Journal*, Vol. 89 N° 6, pp. 593–601, November-December 1992.
- [MAL 97] MALVAR L.J., “Review of static and dynamic properties of steel reinforcing bars”, *ACI Materials Journal*, Vol. 95 N° 5, pp. 609–616, 1997.
- [MAL 98] MALVAR L.J., ROSS C.A., “Review of strain rate effects for concrete in tension”, *ACI Materials Journal*, Vol. 95 N° 6, pp. 735–739, November-December 1998.
- [MAN 67] MANDEL J., “Application de la thermodynamique aux milieux viscoélastiques à élasticité instantanée nulle ou restreinte”, *C.R.A.S*, 264, A, pp. 133–134, 1967.
- [MAR 87] MARTI J., GOICOLEA J., KUMAR R., ALDERSON M., “Impact analysis of transport flasks”, *Int. Conf. on Nuclear Containment*, Cambridge, UK, 6–8 April 1987.
- [MIK 95] MIKAMI H., TAMURA T., SATO M., KISHI N., “Shock absorbing performance of a three-layered cushion system using RC core slab reinforced with AFRP rods”, Proceedings of the *Concrete under Severe conditions CONSEC '95* Conference, Sapporo, Japan, Sakai, Bantia, Gjörv (Ed.), E & FN Spon, pp. 1633–1643, 2–4 August 1995.
- [MIN 87] MINDESS S., BANTHIA N., YAN C. “The fracture toughness of concrete under impact loading”, *Cement and Concrete Research*, 17, pp. 231–241, 1987.
- [MIY 91a] MIYAMOTO A. KING M. W., FUJII M. “Non-linear dynamic analysis of reinforced concrete slabs under impulsive loads”, *ACI Structural Journal*, Vol. 88 N° 4, pp. 411–419, 1991.
- [MIY 91b] MIYAMOTO A. KING M. W., FUJII M., “Analysis of failure modes for reinforced concrete slabs under impulsive loads”, *ACI Structural Journal*, Vol. 88 N° 5, pp. 538–545, 1991.
- [MON 98] MONTANI STOFFEL S., Sollicitation dynamique de la couverture des galeries de protection lors de chutes de blocs, Thesis N° 1899, Ecole Polytechnique Fédérale de Lausanne, Switzerland, 1988.
- [MUR 86] MURIA VILA D., Contribution à l'étude du comportement au choc des bétons, Thesis, INSA de Lyon, 1986.
- [NIC 80] NICHOLAS T., “Material behavior at high strain rates”, *Mechanical Properties at High Rates of Strain*, pp. 277–328, Institute of Physics, London, 1980.
- [PAU 02] PAULTRE P., MITCHELL D., “Seismic response of high-strength concrete structures”, *Proc of 6th Int. Symp. on High Strength/High Performance Concrete*, Leipzig, Germany, König *et al.* (eds.), Leipzig University, pp. 457-471, June 2002.
- [PER 01] PERROTIN P., MOMMESSIN M., MOUGIN J.-P., TONELLO J., “Etude expérimentale du comportement d'une dalle pare-blocs”, XIX^{es} rencontres universitaires de Génie Civil, *COSS'2001*, Lille, pp. 69–75, 3–4 May 2001.
- [PON 95] PONTIROLI C., Comportement au souffle des structures en béton armé, PhD Thesis, Ecole Normale Supérieure de Cachan, 1995.

- [REI 82] REINHARDT H.W., “Concrete under impact loading. Tensile strength and bond”, *Heron*, Vol. 27, N° 3. Delft, The Netherlands, 1982.
- [REI 86] REINHARDT H.W., KÖRMELING H.A., ZIELINSKI A.J. “The Split Hopkinson Bar, a versatile tool for impact testing of concrete”, *Materials and Structures*, 19, pp. 55–63, 1986.
- [REI 91] REINHARDT H.W., WEERHEIJM J., “Tensile fracture of concrete at high loading rates taking account of inertia and crack velocity effects”, *International Journal of Fracture*, Vol. 51, pp. 31–42, 1991.
- [ROS 91] ROSSI P., “Influence of cracking in the presence of free water on the mechanical behavior of concrete”, *Mag. of Conc. Res.*, Vol. 43, N° 154, p. 53–57, 1991.
- [ROS 92a] ROSSI P., WU X., LE MAOU F., BELLOC A., “Effet d’échelle sur le comportement du béton en traction”, *Bull.Liais. Labo. P. et Ch.*, 182, pp. 11–20, 1992.
- [ROS 92b] ROSSI P., VAN MIER J. G. M., BOULAY C., LE MAOU F., “The dynamic behavior of concrete: influence of free water”, *Materials and Structures*, Vol. 25, pp. 509–514, 1992.
- [ROS 95] ROSS C.A., TEDESCO J.W., KUENNEN S.T., “Effects of strain rate on concrete strength”, *ACI Materials Journal*, Vol. 92, N° 1, pp. 37–47, 1995.
- [ROS 96] ROSS C.A., JEROME D.M., TEDESCO J.W., HUGHES M.L., “Moisture and strain rate effects on concrete strength”, *ACI Mat. J.*, Vol. 93 N° 3, pp. 293–300, 1996.
- [ROS 98] ROSSI P., *Les bétons de fibres métalliques*, Presses de l’ENPC, Paris, 1998.
- [SAT 95a] SATO M., NISHI H., SUGATA N., KISHI N., “Full-scale impact test of PC rock-shed with shock absorbing system”, Proceedings of the *Concrete under Severe conditions CONSEC ’95* Conference, Sapporo, Japan, Sakai, Banthia and Gjörv (Ed.), E and FN Spon, pp. 1623–1632, 2–4 August 1995.
- [SAT 95b] SATO M., NISHI H., NAKANO O., KISHI N., MATSUOKA K.G., “Full-scale test on impact resistance of PC girder”, Proceedings of the *Concrete under Severe Conditions CONSEC ’95* Conference, Sapporo (Japan), Sakai, Banthia and Gjörv (Eds.), E & FN Spon, pp. 1644–1652, 2–4 August 1995.
- [SER 98a] SERCOMBE J., “Modélisation du comportement du béton en dynamique rapide. Application au calcul des conteneurs à haute intégrité”, *Etudes et recherches des LPC*, OA 30, 1998.
- [SER 98b] SERCOMBE J., ULM F.-J., TOUTLEMONDE F., “Viscous hardening plasticity for concrete under high rate dynamic loading”, *Journal of Engineering Mechanics*, ASCE, Vol. 124 N° 9, pp. 1050–1057, September 1998.
- [TED 93] TEDESCO J.W., ROSS C.A., KUENNEN S.T., “Experimental and numerical analysis of high strain rate splitting tensile tests”, *ACI Materials Journal*, Vol. 90 N° 2, pp. 162–169, 1993.
- [TOR 88] TORO R. del, *Comportement des nœuds d’ossature en béton armé sous sollicitations alternées*, Thesis, Ecole Nationale des Ponts et Chaussées, Paris, 1988.

- [TOU 93] TOUTLEMONDE F., BOULAY C., GOURRAUD C., “Shock-tube tests of concrete slabs”, *Materials and Structures*, Vol. 26, pp. 38–42, 1993.
- [TOU 95a] TOUTLEMONDE F., Résistance au choc des structures en béton. Du comportement du matériau au calcul des ouvrages, Research report of the LCPC, July 1995.
- [TOU 95b] TOUTLEMONDE F., PIERMATTEI E., ULM F. J., ROSSI P., “Modélisation du béton en dynamique rapide. Résultats d’une première expérience à l’aide d’un modèle d’endommagement avec gradient”, *Bulletin de liaison des Laboratoires des Ponts et Chaussées*, 198, p. 39–52, July–August, 1995.
- [TOU 99a] TOUTLEMONDE F., ROSSI P., Discussion of the 95-M73 article published in the November-December 1998 volume of *ACI Materials Journal*, p. 735 “Review of strain rate effects for concrete in tension”, L.J. Malvar and C.A. Ross, published discussion in *ACI Materials Journal*, Vol. 96 N° 5, p. 614–615, September-October, 1999.
- [TOU 99b] TOUTLEMONDE F., SERCOMBE J., TORRENTI J.-M., ADELIN R., “Développement d’un conteneur pour l’entreposage de déchets nucléaires : résistance au choc”, *Revue Française de Génie Civil*, vol. 3, n° 7–8, p. 729–756, December 1999.
- [TRO 01] TROUILLET P., “Truck impacts on French toll-motorways bridge’s piers”, IABSE conference *Safety, Risk, Reliability – Trends in Engineering*, Malta, 2001.
- [UNO 02] UNOSSON M., Constitutive equations for concrete materials subjected to high rate of loading, Linköping studies in science and technology, Thesis N° 936, Linköping
- [VEC 88] VECCHIO F.J., SATO J.A., “Drop, fire and thermal testing of a concrete nuclear fuel container”, *ACI Structural Journal*, pp. 374–383, July–August 1988.
- [VOS 82] VOS E., REINHARDT H.W., “Influence of loading rate on bond behavior of reinforcing steel and prestressing strands”, *Materials and Structures*, Vol. 15 N° 85, pp. 3–10, 1982.
- [WAT 02] WATSON A.J., “Loading from explosions and impact”, in *Dynamic Loading and Design of Structures*, A.J. Kappos (Ed.), Spon Press, 2002.
- [WEE 88] WEERHEIJM J., REINHARDT H.W., “Biaxial loading for dynamic concrete response”. *J. de Physique*, Coll. C3 (Suppl with No.9, Vol.49), pp. 733–738, 1988.
- [WEE 89] WEERHEIJM J., REINHARDT H.W., “Structural response in impact tests on concrete”, *4th Int. Symp. on the Interaction of Non-Nuclear Munitions with Structures*, Panama City Beach, Florida, USA, pp. 17–21, 1989.
- [WEE 92] WEERHEIJM J., Concrete under impact tensile loading and lateral compression, PhD Thesis, Delft University of Technology, November, 1992.
- [WEE 98] WEERHEIJM J., “Prediction of dynamic tensile strength”, in *ACI SP-175 Concrete and Blast Effects*, W. Bounds (Ed.), paper SP 175-14, pp. 215–239, 1998.

- [ZHA 96] ZHAO H., GARY G., “On the use of SHPB technique to determine the dynamic behavior of the materials in the range of small strains”. *Int. J. Solid. & Structure*, vol. 33, pp. 3363–3375, 1996.
- [ZIE 82] ZIELINSKI A.J., REINHARDT H.W., “Stress-strain behaviour of concrete and mortar at high rates of tensile loading”, *Cem. Conc. Res.*, vol. 12, pp. 309–319, 1982.
- [ZUK 82] ZUKAS J.A., *Impact Dynamics*, John Wiley & Sons, 1982.