



HAL
open science

Design and Hardware Implementation of a Reconfigurable Mostly Digital IR-UWB Radio

Aubin Lecointre, Daniela Dragomirescu, Robert Plana

► **To cite this version:**

Aubin Lecointre, Daniela Dragomirescu, Robert Plana. Design and Hardware Implementation of a Reconfigurable Mostly Digital IR-UWB Radio. Romanian Journal of Information Science and Technology, 2008, 11 (4), pp. 295-318. hal-00420320

HAL Id: hal-00420320

<https://hal.science/hal-00420320v1>

Submitted on 28 Sep 2009

HAL is a multi-disciplinary open access archive for the deposit and dissemination of scientific research documents, whether they are published or not. The documents may come from teaching and research institutions in France or abroad, or from public or private research centers.

L'archive ouverte pluridisciplinaire **HAL**, est destinée au dépôt et à la diffusion de documents scientifiques de niveau recherche, publiés ou non, émanant des établissements d'enseignement et de recherche français ou étrangers, des laboratoires publics ou privés.

Design and Hardware Implementation of a Reconfigurable Mostly Digital IR-UWB Radio

Aubin Lecointre*, Daniela Dragomirescu*, Robert Plana*

* University of Toulouse

LAAS-CNRS

7, avenue du Colonel Roche

31077 Cedex 4, FRANCE

{alecoint, daniela, plana}@laas.fr

Abstract

This paper addresses the problem of radio interface in Wireless Sensor Network (WSN). We study the specific constraints of WSN and we expose how, by using a reconfigurable mostly digital IR-UWB radio, we can solve this problem. WSN context implies constraints such as low power, low cost, small size and simplicity on the radio layer. We present the reconfigurability as a solution to the large diversity of WSN applications. Dynamic reconfigurability is implemented over an IR-UWB radio interface. A two level development is exposed, based on system architecture modelling and hardware implementation. This design flow permits to obtain a reconfigurable IR-UWB transceiver on an ASIC/FPGA implementation. The proposed solution allows data rate, spectrum, and radio range reconfigurability.

Keywords: IR-UWB, mostly digital radio, reconfigurability, FPGA, ASIC, WSN, system architecture modelling, hardware and system co-design.

1. INTRODUCTION

Wireless Sensor Network (WSN) have a lot of applications, such as structure health monitoring networks, home automation, military applications, entertainment networks, In-Flight Entertainment (IFE) networks, inter-vehicles and vehicles-infrastructure networks, etc. These applications are illustrated on figure 1,2 and 3.



Fig. 1. Structure health monitoring network.

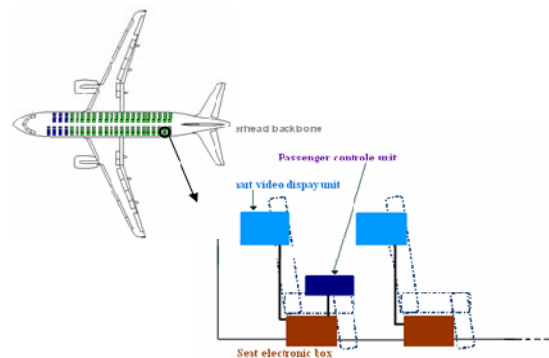

Fig. 2. In Flight Entertainment network application.

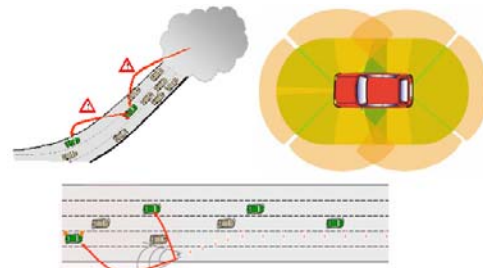

Fig. 3. Inter-vehicles and vehicles-infrastructure network.

Our goal is to propose a reconfigurable transceiver architecture to deal with all the applications of WSN and their distinct requirements. We propose to introduce a unique radio interface which will be able to respond to any kind of WSN radio interface constraints. We will use IR-UWB (Impulse Radio Ultra WideBand) [1] since it could be designed as a mostly digital radio [2], implying a good reconfigurability capacity. In addition IR-UWB is a viable solution for general WSN constraints, which are: low cost, low power, small dimensions and simplicity. While IR-UWB deals with these four constraints, reconfigurability responds to applications constraints (data rate, radio range, spectrum consideration, etc.).

We will also point out our design method to achieve reconfigurable IR-UWB transceiver prototype on ASIC (Application Specific Integrated Circuit) and FPGA (Field Programmable Gate

Array). We use a system architecture and hardware implementation co-design approach.

The paper is laid out as follow. In Section 2, we will review briefly IR-UWB mostly digital radio concept. Section 3 exposes the reconfigurability principle. Our co-design approach is exposed in Section 4, especially system architecture modelling. The transceiver hardware implementation in ASIC or FPGA will be explored in Section 5. Before concluding, in Section 6 we will compare our implementation according to WSN constraints.

2. IR-UWB PRINCIPLE, A MOSTLY DIGITAL RADIO

UWB is defined as a radio technique which uses more than 500 MHz of 10 dB bandwidth [1]. Thanks to this very large bandwidth, UWB can use very short impulse (<10 ns) for transmitting information.

A – IR-UWB concept

These techniques based on pulse are regrouped in the IR-UWB denomination. Sending information over pulse implies the use of pulse modulation. Modulations most commonly used are PPM (Pulse Position Modulation), and OOK (On Off Keying) [1].

While figure 4 illustrates different waveforms of pulses and their spectra, the figure 5 exposes different pulse modulations.

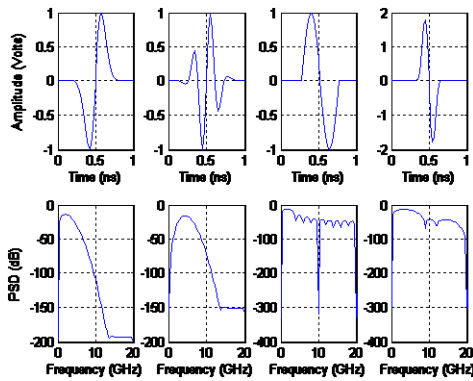

Fig 4. UWB pulse waveform.

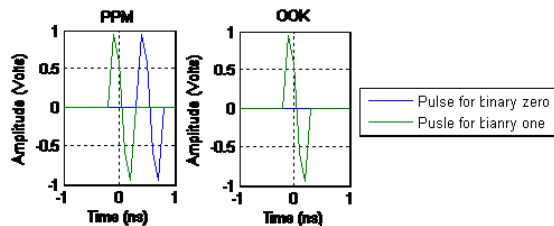

Fig 5. IR-UWB modulation.

The OOK consists in sending a pulse for representing a binary one, while a binary zero is

representing by an absence of impulsion. PPM uses a delay to distinguish the pulse representing the binary one from the binary zero pulse. That is between two distinct pulses we will have a delay [2].

Figure 6 illustrates the emission of the following flow of binary data in PPM and OOK modulation: “1010”.

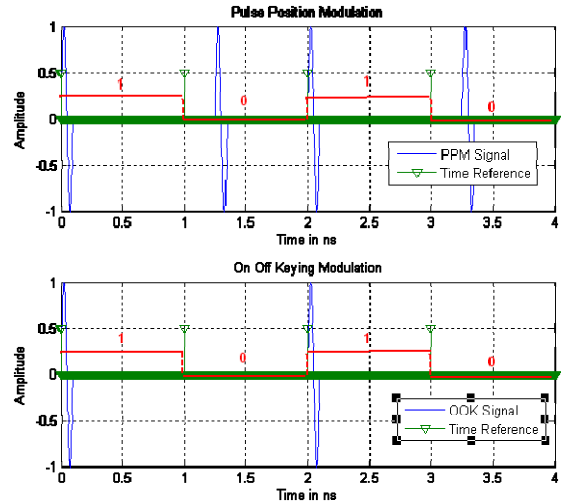

Fig. 6. PPM and OOK modulation for transmitting “1010”

In addition, for enabling multi user capability (an important point in WSN), most of the time, TH (Time Hopping) is used [3]. TH is a dynamic TDMA (Time Division Multiplex Access). The channel is divided into successive frames and each frame is composed with N_c time slots. A TH-code, a pseudo random sequence, is assigned to each distinct user. These codes are orthogonal and they define which time slot will be used in each frame by the associated user. Figure 7 illustrates a case of TH for two users.

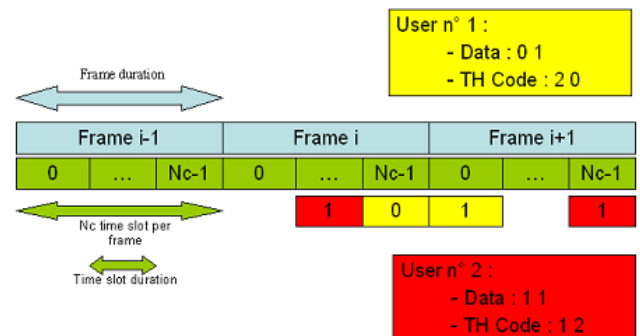
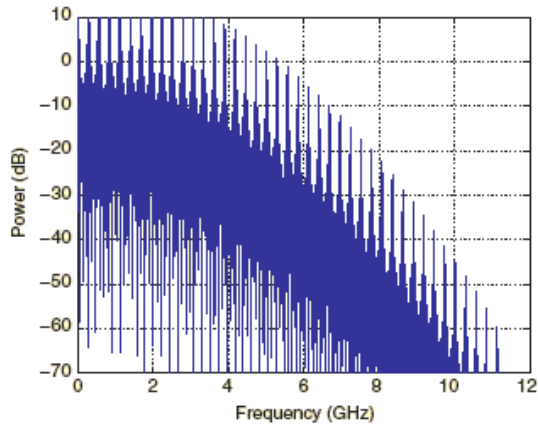
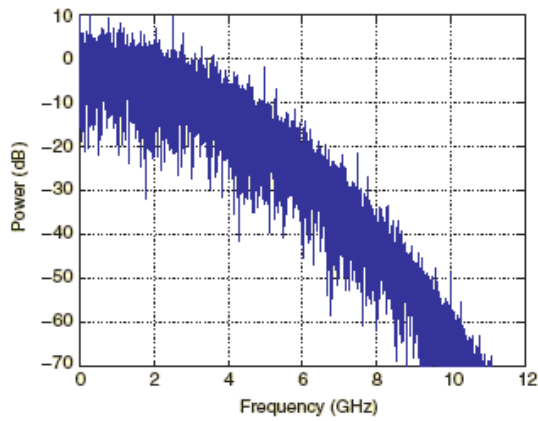

Fig. 7. Illustration of Time Hopping principle for a link with two users.

If we study the spectrum of the IR-UWB signal, using TH permits to randomize the spectrum and TH confers to the spectrum, noise-like properties, as described in figure 8 [3].



(a)



(b)

Fig. 8. 8-a. IR-UWB spectrum without Time Hopping. 8-b. IR-UWB spectrum with Time Hopping.

Figure 8 illustrates that with TH (8-b) the spectral lines disappears. TH code randomizes the spectrum of the signal [3].

This property allows the co-existence with others radio technique such as continuous wave (CW): QPSK, QAM, etc. From a CW point of view, IR-UWB signals are seen as additive noise. Therefore TH allows to decrease the probability of interception and detection of IR-UWB signal.

IR-UWB is a discontinuous emission technique. This noise-like signal will be present in the channel only during a very short time period. This is illustrated in the frequency domain in figure 9a, figure 9b, and in the temporal domain in figure 10.

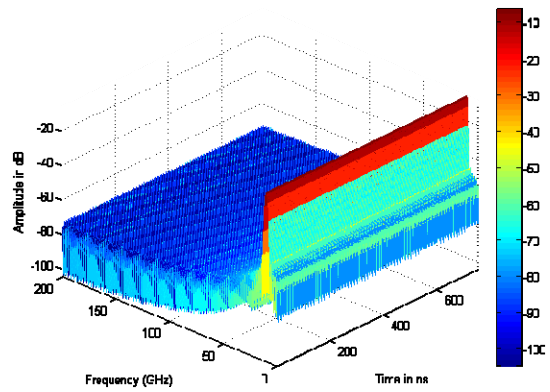
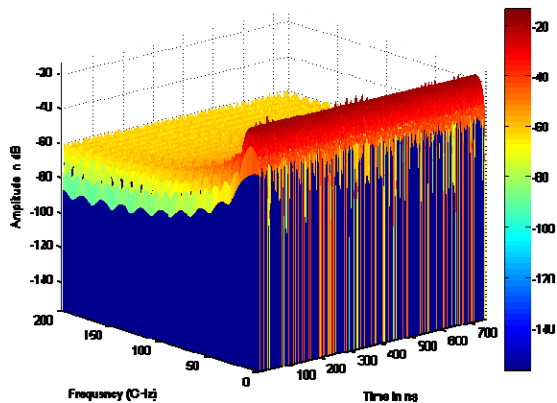

Fig. 9. 9-a. IR-UWB spectrogram. 9-b. Spectrogram of a continuous wave emission.

In Figure 9 we can see that the IR-UWB spectrum (fig. 9a) is larger than a sinusoidal signal spectrum (fig. 9b). In addition the discontinuous property of the IR-UWB signal is also visible in the frequency domain (fig. 9a).

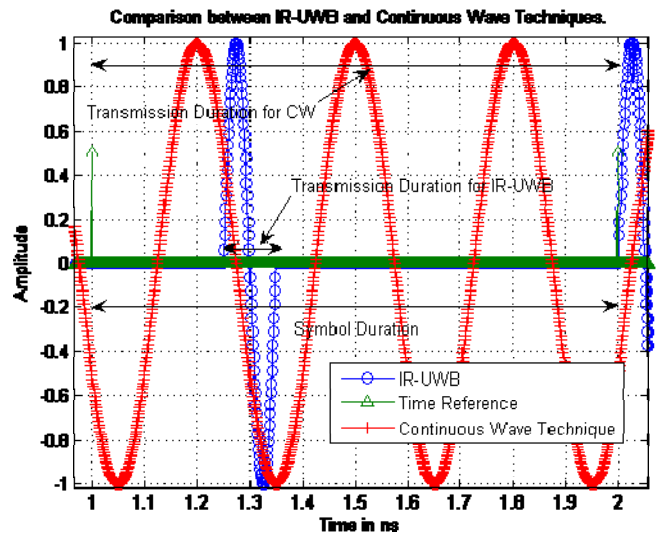

Fig. 10. Comparison in the time domain of classical narrow band technique and IR-UWB technique.

The figure 10 compares classical narrow band technique with IR-UWB at symbol scale. On the figure, we can see the discontinuous aspect of IR-UWB communications. Discontinuous emission allows energy saving as well as interference/coexistence and collision problem.

Figure 10 also illustrates that the duty cycle using pulses is an advantage in a power constraint context. Duty cycle is the ratio between the symbol transmission time and the total transmission time. In IR-UWB, duty cycle is defined as the ratio between the pulse time duration and the interval of time between the pulses. For classical narrow band, the duty cycle will be 1, and for IR-UWB it will be very lower than 1. This low duty cycle is a power consumption advantage for IR-UWB, since during the time of no emission, the emitter will consume much less or it can enter the standby mode. Besides, the UWB international regulation and the

low radio range reinforces the good energy behavior of IR-UWB.

Discontinuous emission allows also to reduce the receiver complexity thanks to its good ISI (Inter Symbol Interference) behavior. Indeed, for achieving large data rates, we use a large bandwidth. Generally, the main problems in radio mobile communications are ISI and fading. Because of multipath, two successive symbols could be received at the same time by the receiver. In narrow band technique with destructive interference due to phase difference, the receive signal would not be correctly received whatever the Eb/No level is.

With IR-UWB, if two successive pulses are separated from each other with a delay larger than the delay spread of the channel, no ISI between pulses and no ISI between bits will appear.

The ISI problem is a main source of complexity in a receiver, thus if we are able to suppress ISI with IR-UWB, we could design simpler receiver. Simplicity implies lower power consumption in comparison with complex receiver.

B – IR-UWB implementation

Because of its time domain approach IR-UWB emitter can be designed without RF stage, including mixer, VCO (Voltage Controlled Oscillator), etc ... (cf. figure 11) [2] [4].

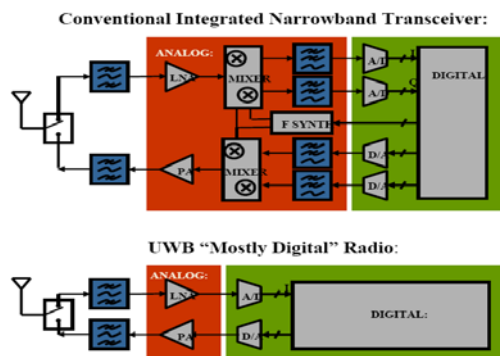

Fig. 11. Illustration of the mostly digital radio concept.

IR-UWB emitter modulates a very short pulse and applies a delay for TH. With the pulse waveform in RAM (Random Access Memory), we could easily set up an IR-UWB emitter. For example, for OOK modulation we will use this pulse waveform when we need to send a binary one. The figure 12 illustrates a mostly digital emitter principle.

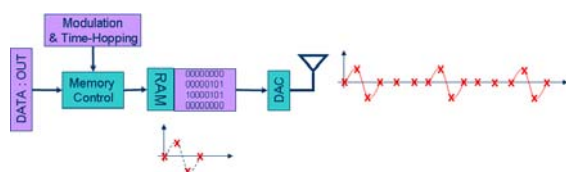

Fig. 12. IR-UWB mostly digital emitter principle.

The concern with this technique is dimensioning. Indeed, the DAC (Digital to Analog Converter) is the key point of the emitter architecture. The characteristics of this latter will define the capabilities of the emitter. Its clock rate and its bit resolution will determine the achievable performance of our emitter. The pulse bandwidth depends on these two parameters. The bandwidth is linked to the clock rate, i.e. the sampling frequency, with the Shannon theorem [5][6]. Sub-sampling theory can slightly impact the performances of the UWB system. In digital systems, the Shannon sampling rate is two time higher than the maximum frequency. In classical narrow band technique, this frequency is not difficult to obtain, but for IR-UWB and its very large bandwidth, is quite more difficult to obtain such sampling frequency, since the IR-UWB band is of several gigahertz.

Because of the mostly digital architecture, the power consumption will be lower than in classical techniques because of the absence of VCO, mixer, and others RF components. In addition, the power needs will decrease according to the Moore's law. For others performance criteria such as size, cost, data rate we can expect that they will follow the Moore's law.

We have studied the behavior of IR-UWB solution regarding the constraints of our WSN context: size, simplicity, power and cost.

Since emitter and receiver are mostly digital, they can be easily implemented on ASIC or FPGA. The transceiver is then composed of an ADC/DAC and a FPGA or an ASIC. By using a mostly digital architecture it is possible to implement reconfigurable radio.

3. IR-UWB RECONFIGURABLE RADIO

Inspired from the software defined radio concept [7], reconfigurability is the ability of a transceiver to adapt itself to the applications needs. For example the transceiver could change the data rate, the radio range or the spectrum occupation.

A – Reconfigurability visions and concept

There are two reconfigurability visions, described in figure 13, the first one exploits FPGA configuration capabilities to change the architecture of the receiver. The second one does not use FPGA capabilities and bases its concept on reconfigurable parameters. The first one has a reconfigurable architecture, while the second one has reconfigurable parameters. The second solution could be also used with an ASIC because only the parameters are reconfigurables [8].

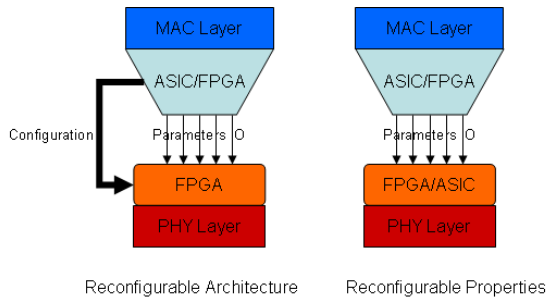

Fig. 13. Two solutions of reconfigurability concept.

The reconfigurable architecture uses the configuration FPGA capability to change the transceiver architecture each time that a reconfigurability process is needed. A pilot component (FPGA or ASIC) is in charge of configuring the FPGA. Two types of configuration could be used (cf. figure 14) [9]:

- the pilot could dispose, on memory, of different version of the FPGA architecture and it will set them up when needed
- the pilot could dispose of a large set of functional blocks and the configuration will consist in reassembling these blocks in order to obtain a new different transceiver

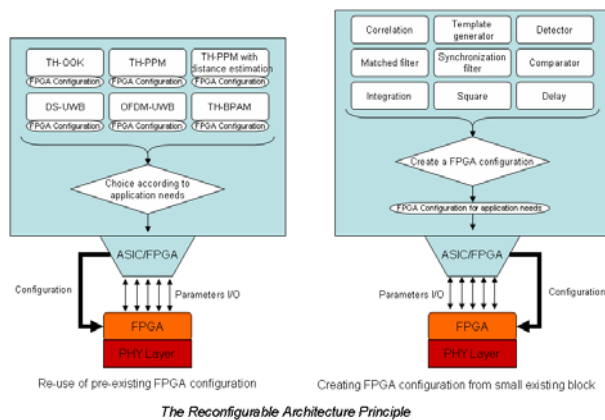

Fig. 14. Two solutions for dynamic architecture reconfigurability.

We implement the reconfigurable parameters circuits. In order to obtain reconfigurable data rate, radio range and spectrum occupation, we have to parameterize the IR-UWB transceiver. The parameters reconfiguration process does not change the architecture but change the key values of the transceiver, such as TH parameters (frame duration, time slot duration, and the number of time slot per frame), IR-UWB parameters (pulse duration, pulse amplitude, and pulse waveform).

If we compare these two solutions we can see that they have both advantages and drawbacks. Concerning WSN constraints, the parameters reconfigurable vision can be better, since only one ASIC is used for the PHY layer, while the architecture reconfigurable vision proposes to use a FPGA and an ASIC. The problem with FPGAs, is

whatever the circuit implementation is, we will always have the performance limitation of the FPGA. Nevertheless with the architecture reconfigurable solution we can obtain a larger achievable performance range.

B - IR-UWB reconfiguration capabilities

In this paper we will only consider this technique: parameters reconfiguration over mostly digital IR-UWB radio. Our proposition of reconfigurable IR-UWB transceiver proposes to implement:

- data rate reconfigurability
- spectrum occupation reconfigurability
- radio range reconfigurability
- TH-code reconfigurability

The viability of an IR-UWB link could be determined thanks to the link budget tool. A link budget for an IR-UWB link is resumed in the following table I.

Table I. Illustration of reconfigurable parameters in an IR-UWB budget link

Parameters	Values	Units
Distance : d	10	m
Time slot duration : Tc	5	ns
Pulse duration : Tp	0,3	ns
Pulse waveform	Sinus pulse	
Data rate : D	0,2	Gbits/s
10dB bandwidth : BP	3,33	GHz
Center frequency : Fo	2,1	GHz
Power before antenna : Pt	0	dBm
Tx antenna gain : Gt	0	dB
EIRP	0	dBm
Rx antenna gain : Gr	0	dB
Pathloss : PL	81,86	dB
Noise : N=k.T.BP	-198,60	dBm
Required Eb/No for PPM@BER=10^-3	12	dB
Achieved Eb/No	38,96	dB
Margin : M	26,96	dB

As illustrated in Table I, the link budget determines the available margin for achieving a required E_b/N_0 . This margin depends of:

- the distance between the emitter and the receiver
- IR-UWB parameters:
 - o Time slot duration
 - o Pulse duration
 - o Pulse waveform
- the bandwidth, the center frequency
- antennas gain
- the noise
- the path loss of the channel.

Thanks to reconfigurability we could change some of these parameters. The achieved E_b/N_0 could be expressed as follow:

$$Eb / No = Pt + Gt + Gr - No - D - PL$$

with :

$$No = f(BP(Tp, pulsewaveform))$$

$$D = f(Tc, Tp)$$

$$PL = f(Fo(Tp, pulsewaveform), d)$$

This equation illustrates the fact that the change of some parameters, such as pulse duration, pulse waveform, time slot duration, could change the capabilities of the link: the data rate, the spectrum occupation and the radio range. These previous parameters are called reconfigurable parameters in [9].

a – Data rate reconfigurability:

With IR-UWB, we could express the data rate as follow:

$$D_{total} = \frac{N_c}{T_f} = \frac{N_c}{N_c \times T_c} = \frac{1}{T_c} [bits / s]$$

with T_c , T_f , and N_c are respectively, the time slot duration, the frame duration and the number of time slot per frame. Changing one of these key values implies a data rate modification. Thus, to have a reconfigurable transceiver, we must be able to change these parameters.

The data rate reconfigurability is interesting for supporting different applications needs and it also permits to increase the radio range when the data rate is smaller and inversely.

b – Spectrum occupation reconfigurability

For IR-UWB, the spectrum occupation reconfigurability depends on the pulse waveform and pulse duration. Indeed these two parameters will impact the two key values of the spectrum occupation: the bandwidth and the center frequency. The figure 15 exposes a panel of distinct non-modulated pulse and their spectrum occupation with different configurations of waveform/pulse duration. We use three distinct waveforms: Gaussian first derivative, Gaussian pulse and sinus pulse. Three different pulses duration are used: $T_p = 1ns$; $0,6ns$; $0,3ns$.

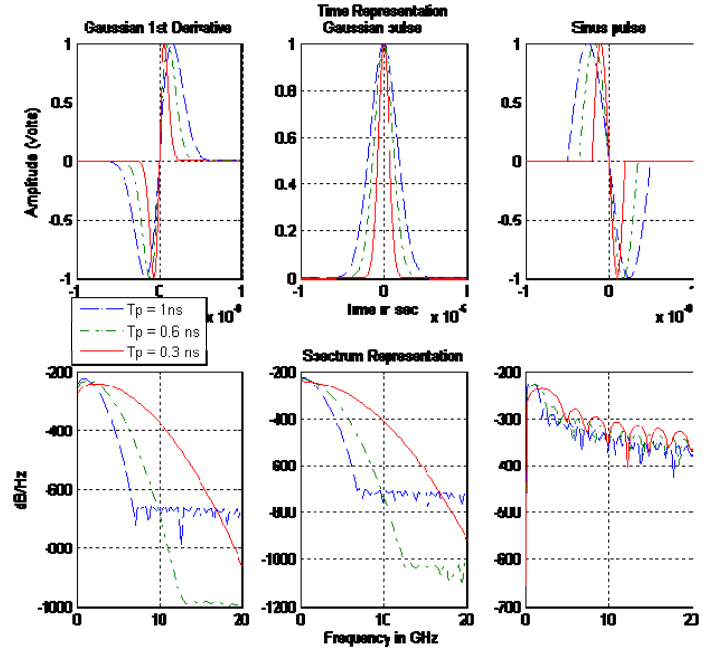

Fig. 15. UWB pulse waveforms and their spectrum at distinct values of pulse duration for three pulse waveforms. Illustration of implied parameters in spectrum occupation reconfigurability.

Table II, summarizes figure 15 results of bandwidth and center frequency in function of T_p the pulse duration.

Table II – Spectrum occupation dependence with pulse waveform and pulse duration.

Pulse	Gaussian 1st			Monopulse			Sinus pulse		
T_p (ns)	1	0,6	0,3	1	0,6	0,3	1	0,6	0,3
BP 10dB (GHz)	1,8	2,7	4,8	1,5	2,1	3,6	1,2	2,1	3,3
Fo (GHz)	0,9	1,5	2,4	0,7	1	1,8	0,9	1,2	2,1

Thus we can see that the spectrum occupation of the IR-UWB signal could be changed if we are able to change the pulse waveform and the pulse duration. This reconfigurability confers to the transceiver the following advantages:

- a good behaviour regarding coexistence and interference problem
- the ability to self adaptation to distinct local regulation
- a radio range variation capability.

c – Radio range reconfigurability

The radio range depends on a lot of parameters such as pulse duration, spectrum occupation, the data rate, the time slot duration [8]. Thus if we can change one of this parameters we could change the radio range without changing the emitted power.

$$Radio_range = f(Pt, Gt, Gr, PL(T_p, pulse_waveform, d), D(Tc), N_o)$$

This radio range capability allows to support different operating area for a wireless sensor network.

d – TH-code reconfigurability

Concerning TH-code reconfigurability, this functionality proposes to change the receiving or the emitting TH-code of the transceiver, as illustrated on the figure 16.

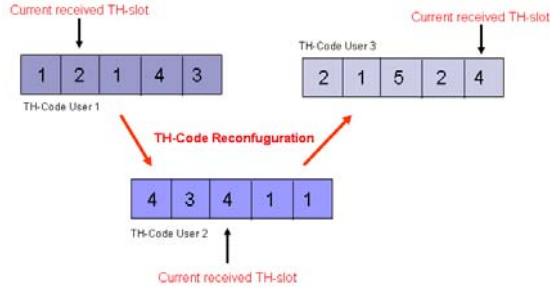

Fig. 16. Illustration of Time Hopping code reconfigurability.

This example illustrates one advantage of the TH-code reconfigurability: self repaired network. Indeed, TH-code reconfigurability could be used to transfer a functionality of one failed node to a viable node.

Before exposing how we set up the reconfigurability concept at the hardware implementation level, figure 17 illustrates our high level reconfigurability vision [9]. Once the reconfiguration signal is sent from the MAC (Medium Access Control) layer to the PHYSICAL layer, the transceiver is able to change its properties while the system is in used.

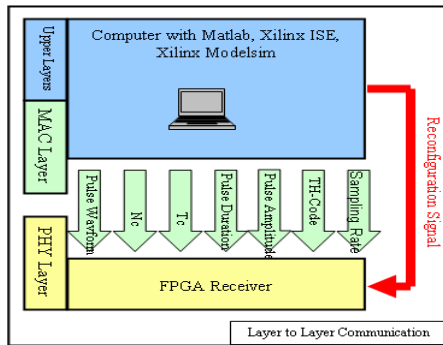

Fig. 17. High level reconfigurability illustration for dynamic properties reconfigurable solution.

4. CO-DESIGN APPROACH FOR RECONFIGURABLE TRANSCEIVER

In order to obtain a reconfigurable receiver, we have developed at two levels (system and hardware) as described in figure 18 [8].

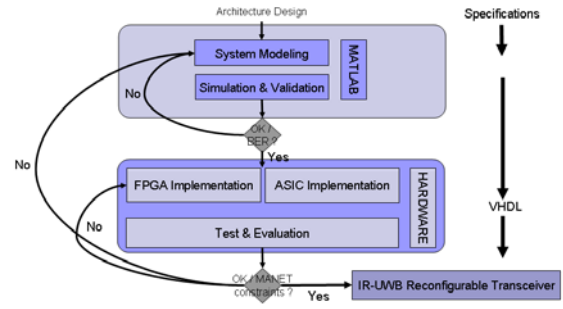

Fig 18. The two level development approach.

The first level consists in designing and modelling the receiver architecture on Matlab. This system level modelling allows us to validate the viability of the proposed architectures in the WSN context. Furthermore, our Matlab platform is also used for performance characterization: BER versus SNR or WSN constraints. If the performances are good enough, we can start the hardware level implementation on FPGA/ASIC. The second level allows to achieve our goal: design an IR-UWB reconfigurable transceiver on ASIC or FPGA. We can see in Figure 18 two feed back links which embody the possibility of re-adjust the architecture if the performances don't satisfy our WSN constraints (low power, small size, low cost and simplicity).

A - High Level Modeling of UWB Transceivers

We have developed with Matlab a full-parametric IR-UWB communication link model which includes emitter, receiver and channel modelling. We have validated our receiver architecture for TH-PPM, and TH-OOK with this model. As described in Figure 19, for TH-PPM we used a double correlation coherent receiver [1] with template synchronization to correctly perform the correlation. This synchronization is carried out by a matched filter [10] and it implies an increase of the complexity of the architecture.

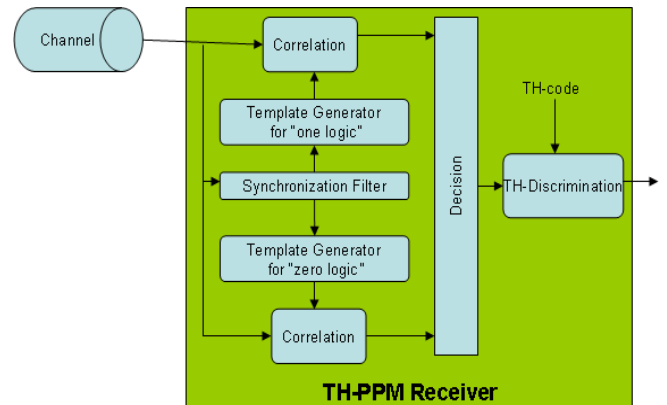

Fig. 19. TH-PPM coherent receiver.

The simplest solution is the TH-OOK receiver [11]. It consists in a non coherent receiver based on energy detection (Figure 20).

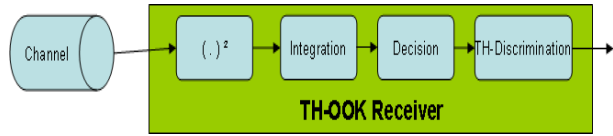

Fig. 20. TH-OOK non coherent receiver architecture.

The emitter architecture is illustrated in figure 12. We have compared these architectures according to the BER versus E_b/N_0 criteria, and the WSN constraints. We have characterized their performances in the IEEE 802.15.4a channel (figure 21) [12]. For the WSN constraints we have obtained the classification by analyzing our three architectures.

Figure 21 shows UWB pulse modulations techniques performances. We can see that IR-UWB systems offer distinct performance. Moreover figure 21 proves that PPM is better than OOK.

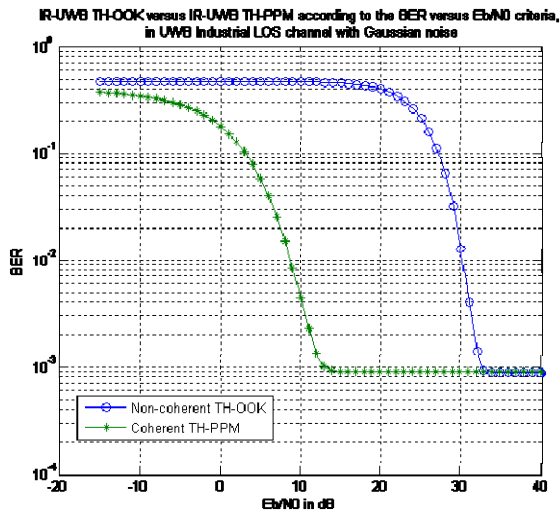

Figure 21. IR-UWB modulation techniques according to evaluation BER versus E_b/N_0 criteria, on IEEE 802.15.4a UWB channel.

By using high level modelling with Matlab, we have demonstrated the viability of IR-UWB transceiver configurable architectures; we have compared them, and validate their operation. Now we are able to implement them at hardware level, on a FPGA/ASIC.

5. A VHDL IMPLEMENTATION OF AN IR-UWB RECONFIGURABLE TRANSCIEVER

Here we propose to use the parameter reconfigurability vision, thus we have to set up a parameter reconfigurable transceiver on FPGA or ASIC. We have implemented reconfigurable

parameters as entries at the interface between the MAC (Medium Access Control) and the PHYsical layer (cf. figure 17).

Our digital circuits are developed in VHDL (VHSIC Hardware Description Language). Thus reconfigurable parameters (for a receiver for example) are defined as follow in order to be embodied as entries [9]:

```
entity reconfigurable_receiver is
Port (
-- inputs
CLK : in std_logic;
RESET : in std_logic;
Renable : in std_logic;
signal_recu : in std_logic_vector(31 downto 0);
load_code : in std_logic;
lg_code : in integer range 0 to 255;
unload_code : in std_logic;
code_j_data : in integer range 0 to 255;
-- reconfigurable parameters
nb_Tc_par_frame_TH : in integer range 0 to 255;
Tc : in integer range 0 to 255;
-- reconfiguration signal
sig_reconf : in std_logic;
-- outputs
out_recepteur_frame : out std_logic;
out_recepteur_chip : out std_logic;
rythme_out_recepteur_chip : out std_logic;
rythme_out_recepteur_frame : out std_logic
);
end reconfigurable_receiver;
```

Figure 22 shows the implementations of these reconfigurable parameters by means of a RTL schematic view of one IR-UWB transceiver.

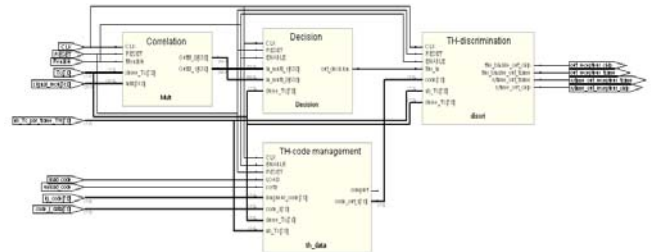

Fig. 22. RTL schematic view of an IR-UWB data rate and TH-code reconfigurable receiver.

Nevertheless this technique has some limitations due to the limited size of the VHDL entity entries. Entry size will define the value's variation range of the different parameters (Time slot duration, number of time slot per frame, pulse amplitude, pulse waveform, etc.). This limit determines the achievable data rate, spectrum occupation, radio range, and the others reconfigurable receiver properties. In other words, we have a dimensioning concern. Achievable performances are linked to the entry size.

For example if we consider the reconfigurable parameters defined as follow:

```
Tc, Tp : in std_logic_vector ( N downto 0 );
```

We can see that the size of these reconfigurable parameters is constrained by N. As a result we can

express the achievable range of reconfigurable parameters. For data rate we have:

$$T_c \in [k \times T_p; 2^N - 1]$$

$$D_{total} (bits / s) = \frac{1}{T_c} \Rightarrow D_{total} \approx \left[\frac{1}{2^N - 1}; \frac{1}{k \times T_p} \right]$$

For spectrum occupation, we have:

$$T_p \in [4; 2^N - 1]$$

$$BP = \frac{1}{T_p} = \left[\frac{1}{2^N - 1}; \frac{1}{4} \right]$$

$$F_0 = function(T_p(N), pulsewaveform)$$

It the same analysis for the radio range reconfigurability:

$$Radio_range = F(PL(T_p, pulse_waveform, d))$$

$$Radio_range = F(PL([1; 2^N - 1], pulse_waveform, d))$$

For the physical implementation, we use two solutions: ASIC implementation using 0.35 μ m AMS 3.60 design kit and Spartan III Xilinx FPGA.

6. ASIC/FPGA IMPLEMENTATION AND COMPARATIVE ANALYSIS

During our study, we design four distinct implementations:

- a static TH-PPM IR-UWB emitter
- a static TH-PPM IR-UWB receiver
- a reconfigurable TH-PPM IR-UWB emitter
- a reconfigurable TH-PPM IR-UWB receiver

With these four implementations we can determine, the impact and the cost of radio reconfigurability. We have implemented on 12 bits.

These four implementations are evaluated according WSN context criteria: size and energy consumption. We have also added reconfigurable performances criteria: data rate and the achievable bandwidth.

Table III and IV compare this criteria for each kind of target: FPGA Xilinx Spartan III and 0.35 μ m AMS 3.60 ASIC.

Table III. Impact of reconfigurability on FPGA Spartan 3 implementation

Version	Synplify FPGA Spartan 3 - Place & Route	
	Maximum Frequency	Size (gates)
Static TH-PPM Emitter	174,216 MHz	2171 + 816
Reconfigurable TH-PPM Emitter	134,862 MHz	1821 + 1488
Static TH-PPM Receiver	150,784 MHz	1846 + 912
Reconfigurable TH-PPM Receiver	112,790 MHz	20689 + 2592

In the case of FPGA implementation, from table III we can say that emitters are simpler than receivers.

Indeed, emitters, static or reconfigurable, achieve a higher frequency. We could also say that reconfigurable circuits are slower than static circuits for an FPGA implementation.

Table IV. Impact of reconfigurability on ASIC implementation

Version	ASIC Design Kit AMS 3.60 at 0.35 μ m		
	Maximum Frequency	Size	Power Consumption
Static TH-PPM Emitter	269.5 MHz	47666	3.2mW @ 100MHz
	529.1 MHz	77500	6.5mW @ 200MHz
Reconfigurable TH-PPM Emitter	222.7 MHz	44900	3.5mW @ 100MHz
	346 MHz	49623	7.2mW @ 200MHz
	526 MHz	72577	13.8mW @ 333MHz
Static TH-PPM Receiver	173.6 MHz	49858	3.5mW @ 100MHz
	216.4 MHz	50367	7.1mW @ 200MHz
	357.1 MHz	64483	11.8 mW @ 285MHz
Reconfigurable TH-PPM Receiver	113.2 MHz	45000	22.4mW @ 100MHz
			26.7mW @ 111MHz

From table IV, we can say that with ASIC implementation, emitters are also simpler and faster than receivers.

ASIC implementation is useful for power concern information, which is a very important criterion in WSN context. We have obtained a design of a static TH-PPM emitter operating at 3.2 mW at 100 MHz. Reconfigurability at emitter side implies a slight increase to 3.5 mW at 100MHz. Receivers could also operate at 3.5 mW in static.

In table V we can find performances of the ASIC implementation. The shown performances are achieved when circuits operate at their maximum frequency.

Table V. ASIC implementations performances

Version	VHDL Parameters			Transceiver Performances at the maximum frequency		
	n	Tc	N	Data rate	Bandwidth used	CAN/CNA required
Static TH-PPM Emitter	4	20	X	25 Mbits/s	125 MHz	500 MSPS
	2	10	X	50 Mbits/s	250 MHz	500 MSPS
	2	6	X	83.3 Mbits/s	250 MHz	500 MSPS
Reconfigurable TH-PPM Emitter	2	6	8	[1.3 ; 55.5] Mbits/s	[111 ; 166.5] MHz	333 MSPS
	2	6	4	[22.2 ; 55.5] Mbits/s	[111 ; 166.5] MHz	333 MSPS
Static TH-PPM Receiver	4	20	X	14.25 Mbits/s	71.25 MHz	285 MSPS
	2	10	X	28.5 Mbits/s	142.5 MHz	285 MSPS
	2	6	X	47.5 Mbits/s	142.5 MHz	285 MSPS
Reconfigurable TH-PPM Receiver	2	6	6	[0.43 ; 16.5] Mbits/s	[37.1 ; 55.5] MHz	111 MSPS
	2	6	4	[7.4 ; 16.5] Mbits/s	[37.1 ; 55.5] MHz	111 MSPS

n : nsampling, sampling rate
Tc : Time slot duration
N : size of reconfigurable parameters

Previous table V summarizes the maximum achievable data rate and bandwidth for static circuits, the range of achievable data rate and bandwidth in the case of reconfigurable circuits. This information depends on VHDL and IR-UWB parameters, such as Tc, the time slot duration, n_{sampling}, the sample rate, and N the size of reconfigurable parameters. If we study the static receiver, we can obtain an IR-UWB link at 47.5 Mbits/s with 142.5 MHz of bandwidth. ADC/DAC must have a sampling rate of 285 MSPS.

These tables shows us an idea of the impact of the reconfigurability on receiver and emitter performances. Analyzing table III, IV and V, we can say that reconfigurability implies a decrease of maximum achievable frequency (and data rate, since it is linked to frequency). We can also observe a slight increase of the power consumption due to reconfigurability implementation. For example, the emitter reconfigurability implies an increase of

about 200 μ W.

On the FPGA we also have a dynamic power due to circuit commutation and a static power necessary to maintain the FPGA configuration. The dynamic power will depend on the number of gates like in the ASIC implementation. The results on the size and the dynamic power on ASIC implementation prove that reconfigurability has a cost. Indeed, the complexity is higher (and the maximum frequency is lower), the data rate is lower, but we can target more application with the same circuit.

Table V give the reconfigurability data rate and bandwidth performances of the transceiver, regarding the range of achievable. The size of the reconfigurable parameter will impact the achievable reconfigurable values. Of course, reconfigurability has a cost, but it allows achieving a radio with a very large range of data rate, bandwidth and radio capability. This reconfigurable radio has the advantage to operate in a lot of different configuration.

Our study has exposed how we could set up dynamic reconfigurability. We have estimated the cost of this essential capacity in the WSN context. The FPGA solution is used for circuit prototyping, but the final circuit will be on ASIC because of its advantages in WSN context: low size and low power. We can expect that low cost circuits could be done because of a high production volume thanks to very demanding targeted applications and the use of a parameter reconfigurable approach.

7. CONCLUSION

This paper proposed a study of mostly-digital IR-UWB reconfigurable transceiver in the context of Wireless Sensor Network. We presented the advantage of IR-UWB radio for WSN constraints such as low power, low cost, small dimensions, and simplicity. We illustrated the fact that an IR-UWB radio can be designed as a mostly digital radio and why this property is very interesting for enabling reconfigurability in WSN context. In fact, in WSN, there are a lot of distinct applications with different needs. Here a reconfigurable radio over IR-UWB was proposed.

This paper studied the capabilities of the reconfigurable parameters for IR-UWB. We have illustrated that spectrum occupation, radio range, data rate, and TH-code reconfigurability can be achieved easily thanks to this time domain approach.

We proposed for the design of a reconfigurable radio over IR-UWB, a two level development flow based on system architecture level and hardware implementation level. With this co-design approach we have obtained a reconfigurable mostly digital IR-UWB radio on ASIC and FPGA. These hardware implementations have illustrated that IR-UWB emitters are simpler and have better

performances (frequency, data rate, consumption) than receiver. Thanks to ASIC and FPGA implementation we have estimated the cost of reconfigurability and the results confirmed our expectations:

- frequency cost: with reconfigurability attainable frequency are lower than in static configuration
- data rate : correlated with frequency, with reconfigurability we obtained lower data rates
- power consumption : reconfigurability slightly increases the power consumption.

On the other hand, reconfigurability will allow to support a wide range of applications and we can satisfy very different requirements with the same reconfigurable transceiver.

In addition with mass production the cost of configurable radio should become very interesting for WSN.

8. REFERENCES

- [1] I. Oppermann, et al., "UWB Theory and Applications", Wiley 2004.
- [2] Ian O'Donnell, et al., "An Integrated, Low-Power, Ultra-Wideband Transceiver Architecture for Low-Rate Indoor Wireless Systems", Berkeley Wireless Research Center, Univ. of California, Berkeley, IEEE CAS Workshop on Wireless Communications and Networking, Pasadena, 2002.
- [3] L. Yang and G. B. Giannakis, "Ultra-Wideband Communications – An Idea Whose Time Has Come", IEEE Signal Processing Magazine, November 2004.
- [4] D. Morche, C. Dehos, T. Hameau, D. Larchartre, M. Pellissier, D. Helal, L. Smaini, « Vue d'ensemble des architecture RF pour l'UWB », LETI, UWB Summer School, Valence, France, oct. 2006 à l'ESISAR.
- [5] Mike Shuo-Wei CHEN, et al., "A subsampling UWB Impulse Radio Architecture Utilizing analytic signalling", IEICE TRANS. ELECTRON. June 2006.
- [6] Shuo-Wei CHEN, "Power Efficient System and A/D Converter Design for Ultra-Wideband Radio", PhD thesis, University of California at Berkeley, May 2006.
- [7] J. Mitola III, "Software radio architecture", Wiley 2000.
- [8] A. Lecointre, D. Dragomirescu and R. Plana, "Software Defined Radio Layer for IR-UWB Systems in Wireless Sensor Network Context", Proceedings of IEEE NEWCAS 2007, August 2007, Montreal, Canada.
- [9] A. Lecointre, D. Dragomirescu and R. Plana, "Study of Mostly Digital Radio for MANET", Proceedings of IEEE CAS Conference, October 2007, Sinaia, Roumanie, pp.237-240.
- [10] M.Z. Win, R.A. Scholtz, "Impulse radio: how it works", IEEE Communications Letters, vol. 2, no. 2, February 1998.
- [11] LM Aubert, Ph.D. thesis: "Mise en place d'une couche physique pour les futurs systèmes de radiocommunications hauts débits UWB », INSA Rennes, France, 2005.
- [12] A. Molisch, K. Balakrishnan, C. Chong, S. Emani, A. Fort, J. Karedal, H. Schantz, U. Schuster, K. Siwiak, « IEEE 802.15.4a channel model – final report », IEEE 802.15.4a sub-group modelling.