



**HAL**  
open science

## Auditory assessment of structural uncertainties

Vincent Koehl, Etienne Parizet

► **To cite this version:**

Vincent Koehl, Etienne Parizet. Auditory assessment of structural uncertainties. Novem 2005, Apr 2005, Saint-Raphaël, France. Paper n°49. hal-00414814

**HAL Id: hal-00414814**

**<https://hal.science/hal-00414814v1>**

Submitted on 26 Jun 2013

**HAL** is a multi-disciplinary open access archive for the deposit and dissemination of scientific research documents, whether they are published or not. The documents may come from teaching and research institutions in France or abroad, or from public or private research centers.

L'archive ouverte pluridisciplinaire **HAL**, est destinée au dépôt et à la diffusion de documents scientifiques de niveau recherche, publiés ou non, émanant des établissements d'enseignement et de recherche français ou étrangers, des laboratoires publics ou privés.

# Auditory assessment of structural uncertainties

V. Koehl and E. Parizet

Laboratoire Vibrations Acoustique de l'INSA de Lyon,  
25 bis, avenue Jean Capelle, 69621 VILLEURBANNE Cedex, FRANCE

## Abstract

*This paper illustrates with an elementary physical model how structural uncertainties can be perceived. The sound emitted by an object subject to classical structural dispersions encountered in industry is synthesized for subjective assessment. Two types of perceptive tests have been used for this purpose, giving quantitative and qualitative evaluations of the sounds. These answers have enabled to determine which dispersions are the most influent in the perceptive assessment of the sound.*

## 1 Introduction

Structural dispersions have been these past years a major case of study. Most studies [1-3] have focused on the outcomes of dispersions on the vibratory and acoustical performances of structures. But a very few of them have considered the perceptual consequences on the noise emitted by an object submitted to structural dispersions.

The aim of this paper has been to study a basic structure affected by typical dispersions and to evaluate the propagation of those uncertainties on the sound assessment.

## 2 Physical model for sound synthesis

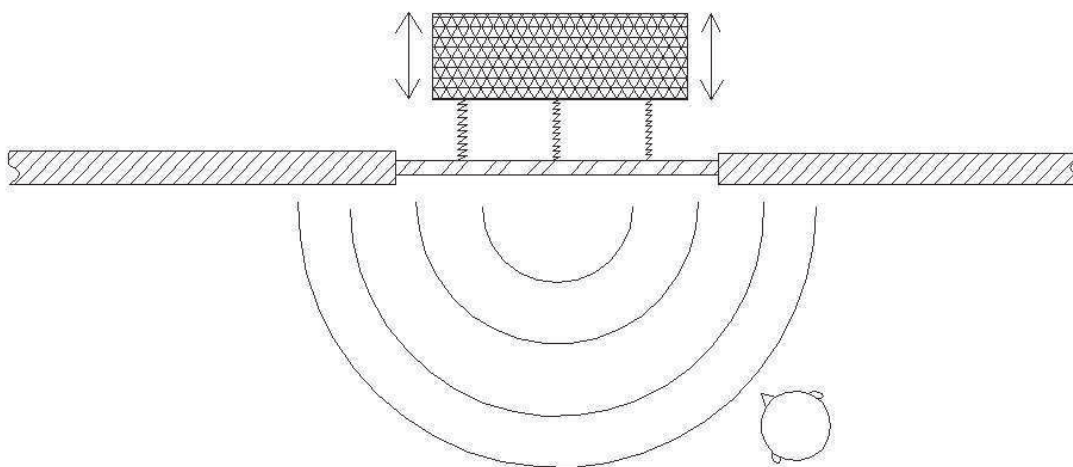

Figure 1: Diagram of the industrial object submitted to structural uncertainties.

The object studied in this paper was an elementary model on which classical industrial dispersions could be easily reproduced. An engine has been attached through three mounts to a plate that radiated and emitted sound. A listener supposed to be in the vicinity of this object had to assess the synthesized sound.

## 2.1 Flexural vibration of the plate

Considering only the flexural vibration of a simply supported rectangular thin plate, the complete solution to the wave equation was known [4].

At the vibrational orders  $p$  and  $q$ , the natural frequency of the plate was:

$$\omega_{pq} = \sqrt{\frac{D}{\rho h}} \cdot \left( \left( \frac{p\pi}{L_x} \right)^2 + \left( \frac{q\pi}{L_y} \right)^2 \right) \quad (1)$$

$D$  was the rigidity of flexure of the plate:

$$D = \frac{E \cdot h^3}{12 \cdot (1 - \nu^2)} \quad (2)$$

$\rho$ ,  $E$  and  $\nu$  were respectively the density, the Young's modulus and the Poisson's ratio of the material.  $h$ ,  $L_x$  and  $L_y$  were the thickness, length and width of the plate.

Due to a shock at point of coordinates  $X$  and  $Y$  on the plate, the velocity distribution on the surface of the plate can be formulated as:

$$u_A(x, y) = \sum_{p=1}^{\infty} \sum_{q=1}^{\infty} j\omega \frac{\sin\left(\frac{p\pi}{L_x} \cdot X\right) \sin\left(\frac{q\pi}{L_y} \cdot Y\right) \sin\left(\frac{p\pi}{L_x} \cdot x\right) \sin\left(\frac{q\pi}{L_y} \cdot y\right)}{\omega^2 + j\eta\omega\omega_{pq} + \omega_{pq}^2} \cdot \frac{1}{\rho \cdot h \cdot L_x \cdot L_y/4} \quad (3)$$

$\eta$  is the modal damping.

This can also be seen as the plate transfer function for transverse velocity/input force from one exciting point of coordinates  $X$  and  $Y$  to a receiving point of coordinates  $x$  and  $y$ .

## 2.2 Mobility method

The considered structure was made by two substructures connected by springs. The first sub-structure was the source and its mobility matrix  $[M_1]$  and decoupled velocity  $\{\widetilde{V}_1\}$  were known.

$$\{V_1\} = [M_1] \cdot \{F_1\} + \{\widetilde{V}_1\} \quad (4)$$

$$\{V_2\} = [M_2] \cdot \{F_2\} \quad (5)$$

$$\{F_1\} = -\{F_2\} \quad (6)$$

$$\{V_1\} = \{V_2\} + \{F_1\} \cdot [M_r] \quad (7)$$

$[M_2]$  Mobility matrix of the receiving structure (thin plate).

$[M_r]$  Stiffness matrix of the connecting points (springs).

For the engine mounts, assumed to be pure springs, it was not possible to deal with mobility, but rather with speed jumps. A spring did not have any mobility matrix, as the force at one of its ends was always entirely transmitted to the other end. Nevertheless, it imposed a condition on velocities.

The solution to this system gave the efforts on the plate at each connecting points. When injecting these efforts to equation 3, it was possible to reconstitute the full transverse velocity field on the plate.

## 2.3 Radiated pressure

Knowing the transverse velocity field on the plate, the radiated pressure at a point of spherical coordinates  $r$ ,  $\theta$  and  $\phi$  could be finally obtained with Rayleigh's Integral [5]:

$$p = \frac{j\omega\rho_0}{2\pi} \cdot \int_S u_A \cdot \frac{e^{-jkd}}{d} dS \quad (8)$$

$d$  being the distance separating the elementary surface considered from listening point.

$$d = \sqrt{(X_0 - x)^2 + (Y_0 - y)^2 + Z_0^2} \quad \text{where} \quad \begin{cases} X_0 = r \cdot \sin \theta \cos \phi + \frac{L_x}{2} \\ Y_0 = r \cdot \sin \theta \sin \phi + \frac{L_y}{2} \\ Z_0 = r \cdot \cos \theta \end{cases} \quad (9)$$

The spherical coordinates take their origin at the center of the plate, the origin used to calculate the vibratory speed of the plate was located at its corner.

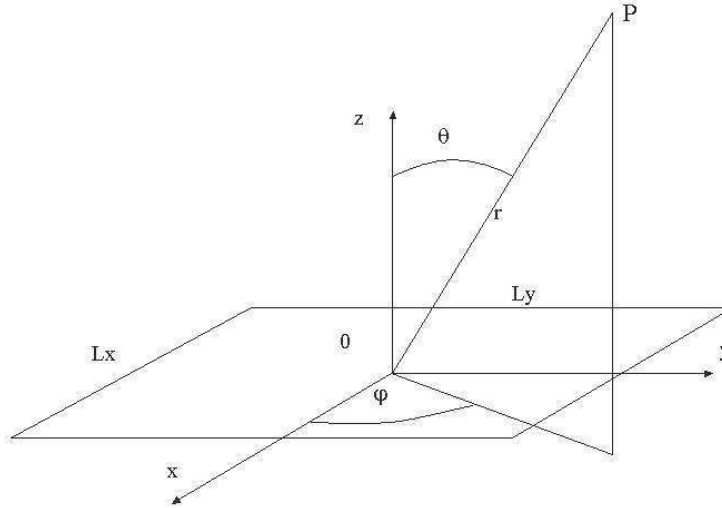

Figure 2: Spherical coordinates of the listening point P.

## 2.4 Dispersions

### 2.4.1 Uncertainties affecting the structure

The structural uncertainties applied to this model concern the thickness, the damping of the plate and the stiffnesses of the springs. The nominal thickness of the plate is  $1mm$ . According to the standard NF A 46-402 described in [6], the tolerance interval for the thickness of this plate is  $0.065mm$ , which means that the thickness can vary between  $0.9675mm$  and  $1.0325mm$ .

The plate is a sandwich metal sheet with elastomer core. The damping of the plate is sensitive to temperature variations [7] and can vary between 2% and 4%.

When sampling randomly the transfer function radiated pressure/input force with the uncertainties affecting it lying within their tolerance range, large magnitude fluctuations appeared above 500Hz. The engine spectrum has to give much energy between 500 and 2000Hz in order to reproduce hyper sensibility of the radiated pressure.

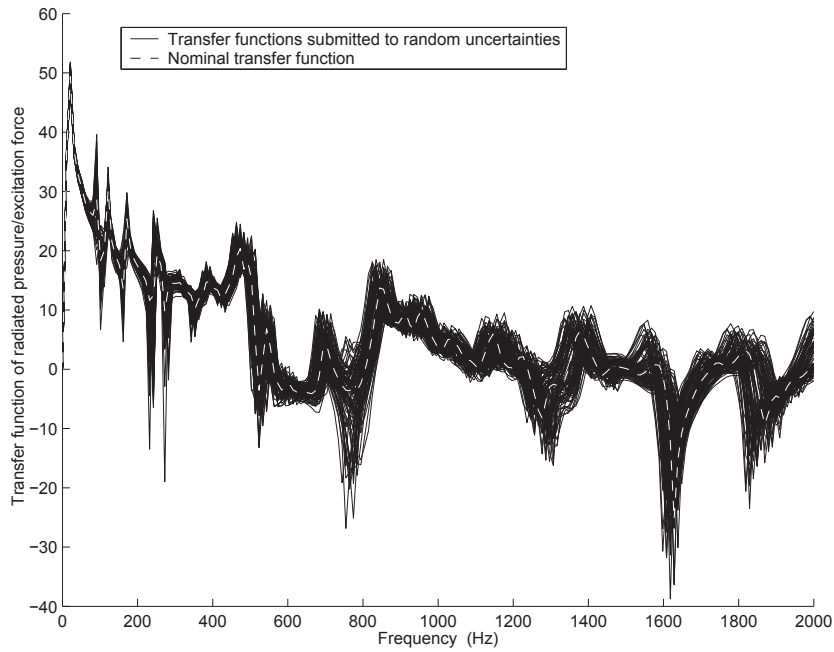

Figure 3: Monte Carlo sampling of the transfer functions.

#### 2.4.2 Uncertainties caused by the source

The engine spectrum was an 50Hz-harmonic excitation. To focus on the sensible frequency range, its amplitude increased slightly with the frequency.

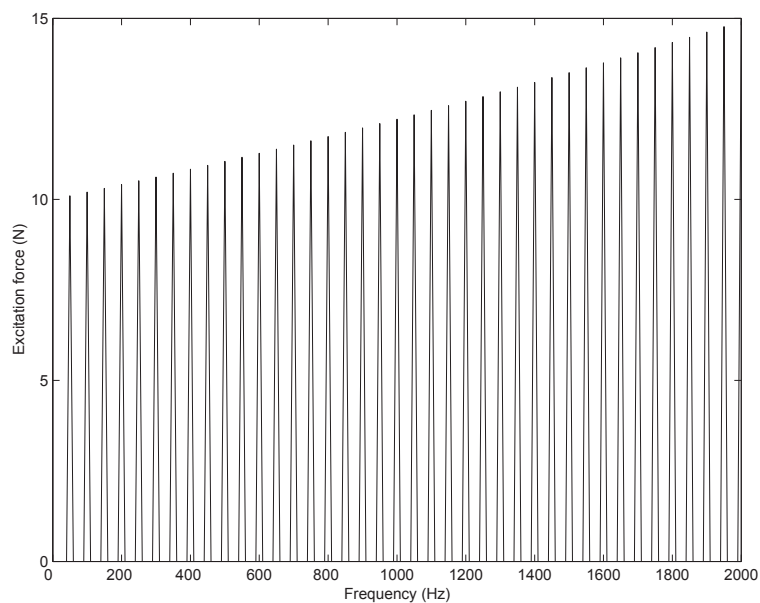

Figure 4: Engine excitation spectrum.

Some uncertainties have also been introduced by this source spectrum [8]. Its global amplitude might fluctuate in a range of 3dB. An axial misalignment has also been simulated by increasing the amplitude of the even harmonics of 1.5dB.

### 2.4.3 Summary

For each identified uncertainty, 3 states have been observed: the lower limit, the middle (nominal value) and the upper limit of the uncertainty range. For the axial misalignment, only two states have been observed.

Therefore, for all factors except *A*, level 2 was the nominal state, levels 1 and 3 were respectively the lower and upper limit of the tolerance range. Concerning the factor *A*, level 1 corresponded to the aligned state and level 2 corresponded to the misaligned one.

Factor designation	Corresponding mechanical dispersion	Level and signification		
		1	2	3
A	Axial misalignment	0	+1.5dB	
B	Level of the spectrum	-1.5dB	0	+1.5dB
C	First engine mount	80N/mm	100N/mm	120N/mm
D	Second engine mount	80N/mm	100N/mm	120N/mm
E	Third engine mount	80N/mm	100N/mm	120N/mm
F	Thickness	0.9675mm	1mm	1.0325mm
G	Damping	2%	3%	4%

Table 1: Description of the factors and levels.

## 2.5 Sound synthesis

Multiplying the transfer function by the force spectrum of the engine, the pressure spectrum at the listening point was obtained. Transposing this spectrum in the time domain by IFFT, a short sound sequence appears. Equal short sequences have then been putted end to end in order to obtain a longer one.

This sequences have then been submitted to the listener’s assessment.

## 3 assessment of the radiated sound

After synthesis, the sound of the radiating plate radiating was submitted to the listeners panel for perceptive judgement. Two type of perceptive tests have been set up for this purpose. The first one was quantitative, the dissimilarity between sounds had to be rated on a continuous scale. The second test was rather of qualitative nature. The sounds had to be grouped into clusters the listeners were free to determine.

### 3.1 Listeners

The same 20 listeners have participated to both tests. They were students aged from 22 to 25.

### 3.2 Mixed test

#### 3.2.1 Procedure

In order to limit the number of sounds necessary to the listening tests, the sounds for this test were sampled using a fractional experimental design.

Each level of each factor was equally confronted to all others factors' effects. This technique allowed to extract each factor effect with only a few measurements.

According to Taguchi's Designs [9], a modified  $L_{18}$  table allowed to determine the contributions of all the chosen uncertainties. Using this design, only 18 measurements were necessary to obtain the factors contribution to response.

Each sound has been recorded by looking at the corresponding line of the experiment matrix and by placing the factors at the right level. This table also allowed to test a possible interaction between the factors  $A$  and  $B$  of the design.

Measurement number	1	2	3	4	5	6	7	(1.2)
	Controlled factors							Int.
	A	B	C	D	E	F	G	AB
1	1	1	1	1	1	1	1	1
2	1	1	2	2	2	2	2	1
3	1	1	3	3	3	3	3	1
4	1	2	1	1	2	2	3	2
5	1	2	2	2	3	3	1	2
6	1	2	3	3	1	1	2	2
7	1	3	1	2	1	3	2	3
8	1	3	2	3	2	1	3	3
9	1	3	3	1	3	2	1	3
10	2	1	1	3	3	2	2	4
11	2	1	2	1	1	3	3	4
12	2	1	3	2	2	1	1	4
13	2	2	1	2	3	1	3	5
14	2	2	2	3	1	2	1	5
15	2	2	3	1	2	3	2	5
16	2	3	1	3	2	3	1	6
17	2	3	2	1	3	1	2	6
18	2	3	3	2	1	2	3	6
19	1	1	1	2	3	1	2	1
20	1	2	3	1	2	3	1	2
21	1	3	2	3	1	2	3	3
22	2	1	3	2	1	3	2	4
23	2	2	1	3	2	1	3	5
24	2	3	2	1	3	2	1	6
Ref	1	2	2	2	2	2	2	2

Table 2: Adjusted  $L_{18}$  experiment matrix + complementary measurements + reference sound

The table above summarized the 25 sounds used during this experiment. It contained 18 sounds configured according to the  $L_{18}$  design. Six configurations not included in this design have been added to check the factors' effects additivity. The last configuration of the table in the nominal state.

The response the listeners had to give during this test was the degree of dissimilarity between the 24 sounds and a reference one. The measurement of the response on a continuous scale was a necessary condition to the use of the experimental designs.

As shown on figure 5, the listener could reach all sounds on the same test window. Using a mixed test procedure [10], he had to compare 24 sounds to a reference one and to rate them on a common scale.

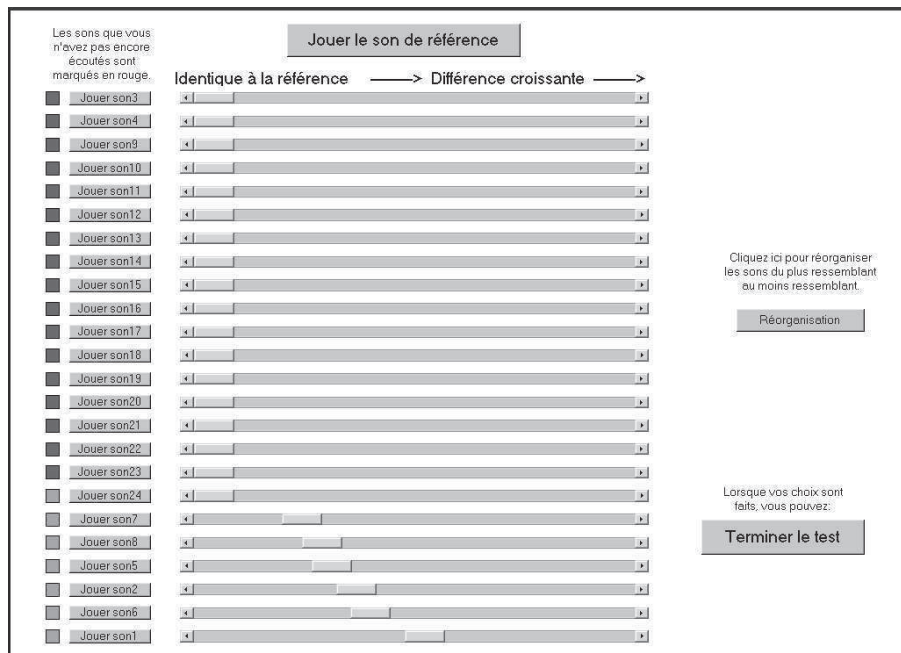

Figure 5: Test window of the first experiment.

### 3.2.2 Data analysis

As shown on figure 6, a low variability between listeners was observed, enabling to extract the factors effects by processing the mean dissimilarity scores.

An analysis of variance gave the following contributions for each factor:

A	B	C	D	E	F	G	AB	Residual
9.66%	39.98%	14.84%	5.16%	0.53%	21.57%	5.46%	0.20%	2.60%

Table 3: Factors Contribution to the total variance.

The tested interaction and the residual part were granted a very weak contribution.

The examination of the responses allowed to extract the effects of each factor at each level. Since the model was an additive one, each configuration score could be recomputed and compared to the experiment.

The computed and measured dissimilarity scores were very close to one another, showing that no interaction took significant part in the response and confirming the results of the analysis of variance shown in table 3. Nevertheless a two-way analysis of variance [11] was carried out and confirmed that no two-way interaction had a statistically significant effect. Since the fractional experimental design gave an additive model of dissimilarity, it was very important that the factors were independent or that their interaction did not influence significantly the listeners' responses.



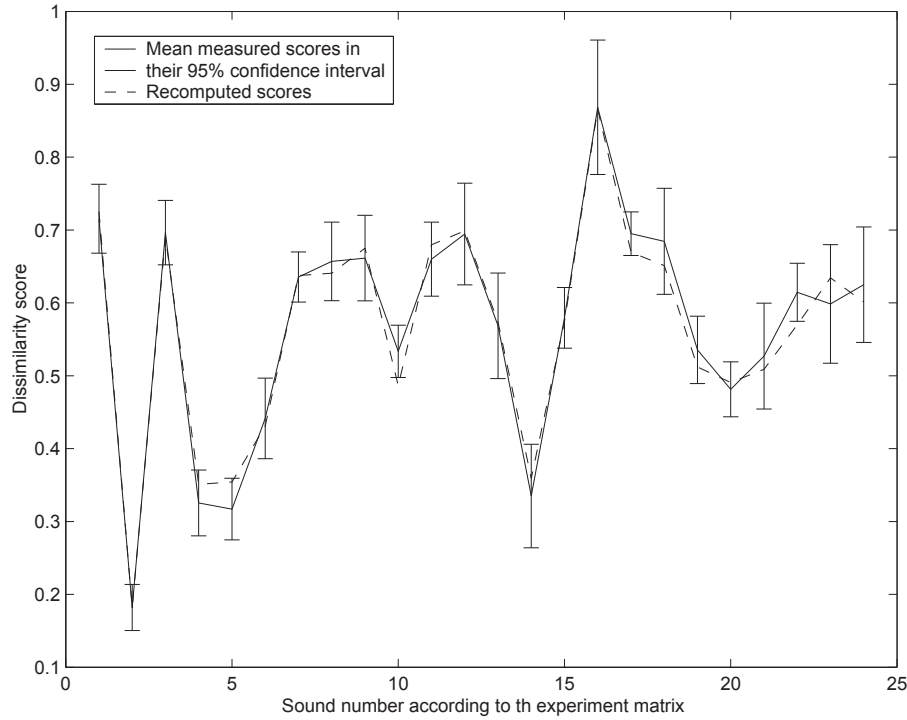

Figure 6: Comparison between measured and computed dissimilarity scores.

When correlating the scores collected during this experience with the classical psychoacoustic descriptors, it appeared that the listeners' choices were mostly conditioned by the loudness. The correlation coefficient between the sound loudness and the dissimilarity score was  $0.85^{**}$  ( $F = 60$ ).

A linear regression with two factors (loudness and roughness) made this coefficient correlation grew to  $0.90^{**}$  ( $F = 29$ ).

These psychoacoustics descriptors have been computed using 01dB dBSONIC Software. The Loudness has been computed using ISO 532 B standard, and the loudness has been computed using an Aures-based model [12].

The influence of factors  $A$  and  $B$  was obvious because of their contribution to the global radiation level.

When looking at the transfer function radiated pressure/input force, the uncertainty on the thickness ( $E$ ) caused frequencies modulation and amplitude fluctuation.

The dispersion on the modal damping led to a slight amplitude fluctuation, but its influence was obviously not as important.

Depending of the position of the connecting points, the uncertainties on the springs' stiffnesses had variable consequences. This dispersion did affect the amplitude of the resonance frequencies, the more modes were affected the more this dispersion had a significant contribution. For example, the dispersion on the spring connected to the center of the plate has affected less modes than the the one on a spring close to a corner, its effect on the perception was thus weaker.

### 3.3 Classification test

#### 3.3.1 Procedure

During this test the listeners were asked to organize the sounds they considered as similar into categories. The mixed test did reasonably not allow to assess more than twenty-five sounds at once. The categorization test could include much more sounds than the dissimilarity test. Again, the 24 sounds from the first experiment (see table 2) were to assess. The 14 sounds contained in table 4 completed the stimulus range. These extra sounds enabled to test some extra configurations, not tested during the first experiment, for instance, two identical sounds (25,26), some extreme configurations of the design (27-30) and some configurations concerning only the factors affecting the level (31-38).

Measurement number	1	2	3	4	5	6	7	(1,2)
	Controlled factors							Int.
	A	B	C	D	E	F	G	AB
25	1	2	2	2	2	2	2	2
26	1	2	2	2	2	2	2	2
27	1	3	3	3	3	3	3	3
28	2	1	1	1	1	1	1	4
29	2	2	2	2	2	2	2	5
30	2	3	3	3	3	3	3	6
31	1	1	1	1	1	2	1	1
32	1	1	1	1	1	2	3	1
33	1	1	3	3	3	2	1	1
34	1	1	3	3	3	2	3	1
35	1	3	1	1	1	2	1	3
36	1	3	1	1	1	2	3	3
37	1	3	3	3	3	2	1	3
38	1	3	3	3	3	2	3	3

Table 4: Complementary measurements for the classification test.

On the screen, as shown on figure 7, the listeners had to group sounds into clusters of sounds according to the similarity of the items they contained. The number of categories was not imposed and could therefore lie between one and an thirty-eight.

Either within a category or between categories, no distance was considered during this experiment. Each individual response has been processed as a membership matrix:

$$a(i, j) = \begin{cases} 1 & \{i, j\} \text{ are in the same classe} \\ 0 & \text{otherwise} \end{cases}$$

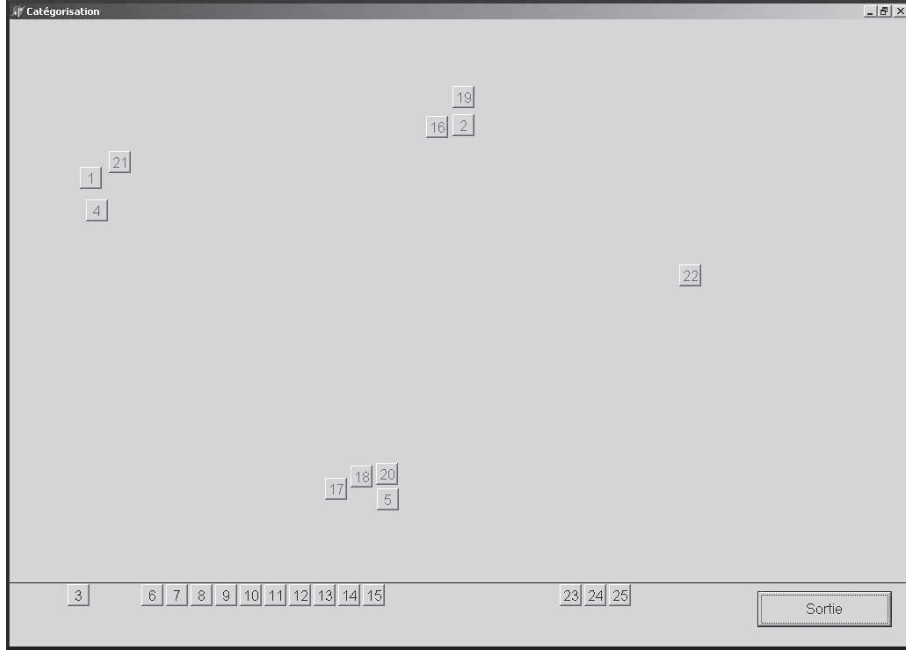

Figure 7: Test window of the second experiment.

### 3.3.2 Data analysis

Each listener gave thus a specific partition of the stimulus range. Two major informations could be extracted from the individual responses, the raw distance matrix and the optimal partition.

The global membership matrix  $[M]$  has been built by adding the individual membership matrices.

Sound	1	2	3	4	...	36	37	38
1	20	3	4	3	...	2	0	0
2	3	20	7	9	...	7	2	3
3	4	7	20	7	...	4	0	2
3	3	9	7	20	...	8	1	3
⋮	⋮	⋮	⋮	⋮	⋮	⋮	⋮	⋮
36	2	7	4	8	...	20	0	8
37	0	2	0	1	...	0	20	3
38	0	3	2	3	...	8	3	20

Table 5: Global membership matrix.

The raw distance matrix  $[D]$  could then be obtained:

$$[D] = [1] - \frac{[M]}{N} \quad \text{where } N \text{ is the number of listeners}$$

This distance matrix has then been used to find the agglomeration tree for this test. The method used for hierarchical clustering has been the average linkage, the mean distance between two items of each cluster was considered. Cutting the tree at a given agglomeration level gave the corresponding ideal partition. The Rand Index [13, 14], giving the ratio on concordance between two different partitions of the same ensemble, was at its maximum for seven classes.

Cutting the agglomeration tree in order to have seven classes, the following partition appeared:

**Optimal Partition:**

1 <sup>st</sup> class	1	12	28	6	19	8	23	13	17
2 <sup>nd</sup> class	2	4	34	32	3	11	22		
3 <sup>rd</sup> class	5	15	7	20					
4 <sup>th</sup> class	9	35	14	16	24	37			
5 <sup>th</sup> class	10	25	26	36	29				
6 <sup>th</sup> class	18	21	27	30	38				
7 <sup>th</sup> class	31	33							

Table 6: 38 tested sounds distributed in 7 classes.

Therefore, this partition was the one that fitted at best the 20 individual partitions. Only one structural factor was directly related to the presence in classes. All the sounds present in the first class had their thickness at level 1. A Repeated Measurements ANOVA on ranks showed that there is a statistical link between thickness and classes.

Considering the dissimilarities as euclidean distance, a classical multidimensional scaling [15] has been carried out on the raw distance matrix. It provided the latent dimensions of the perceptive space. As the distance matrix has been built using partitions (and thus discrete data), it was not possible to fully reconstitute the perceptive space, even with  $P - 1$  dimensions,  $P$  being the number of stimuli. However 5 dimensions were sufficient to satisfactorily reconstitute the perceptive space. The first dimension appeared to be directly linked to the thickness of the plate, it concerned the loudness in a specific range conditioned by this parameter:

$$Dim_1 = \frac{\overline{Loudness_{2 \rightarrow 4Bark}}}{\overline{Loudness_{1 \rightarrow 24Bark}}}$$

Depending on the value of its first dimension, a sound might be placed either in class 1 or in the 6 other ones, as shown on table 6. The  $t$ -test confirmed that the difference in the mean values of  $Dim_1$  between the two groups was greater than would be expected by chance ( $t = -13.187$ ,  $P = < 0.001$ ). The second and third dimension were the loudness and the roughness. These criteria were then influent in both tests. The fourth and fifth dimensions were not clearly definable.

### 3.3.3 Similarities and differences between the two experiments

The principal similarity is that the assessment of the sound was mainly fixed by its loudness and roughness. This confirmed roughly the contribution of each factor shown by the first experiment. However, the thickness appeared to be much more influent during the second experiment than during the first one. Two possible explanations could be found:

- The responses given during these tests were strongly related to the stimulus range. The sounds added to the second experiment have modified the contribution of the indicators used by the listeners in their judgment.
- A possible bias in one of the experiments. For example, it could be possible that, in the first experiment, listeners evaluated the annoyance of sounds, though they were asked to evaluate their similarity with the reference sound. That could explain the importance of the loudness in the results of the first test.

## 4 Conclusions and perspectives

Although these two experiments did not provide exactly the same conclusions, they gave a clear overview of the uncertainties that have a significant outcome on perception.

These experiments have also permitted to understand how these dispersions could affect the perception of the sound. The psychoacoustic indicators illustrating this phenomenon have been defined.

The following step to this study would be to build various object based on this model, each affected by the uncertainties modifying perception and to observe if they can be mistaken because of the dispersions.

## References

- [1] R.J. Bernhard, M.S. Kompella, 'Measurement of statistical variation of structural-acoustical characteristics of automotive vehicles', SAE Paper 931272. (1993)
- [2] W.F. Resh, 'Some results concerning the effect of stochastic parameters on engine mount system behavior', SAE Paper 911054. (1991)
- [3] M. Ouisse, J.L. Guyader, *Journal of Sound and Vibration*, 'Vibration sensitive behavior of a connecting angle: case of coupled beams and plates', **267**, n°4, 809-850, (2003).
- [4] J.L. Guyader, *Vibrations des milieux continus*. (Hermes science, 2002)
- [5] L. Shuyu, *Journal of Sound and Vibration*, 'Study on the radiation acoustic field of rectangular radiators in flexural vibration', **254**, n°3, 469-479, (2002).
- [6] Agence française de normalisation, *Produits siderurgiques: Dimensions et tolerances*. (AFNOR, 1995)
- [7] Centre technique des industries mécaniques, *Matériaux pour l'isolation acoustique des machines et des véhicules*. (CETIM, 1995)
- [8] C. Boulenger, C. Pachaud, *Surveillance des machines par analyse des vibrations: du dépistage au diagnostic*. (AFNOR, 1995)
- [9] J. Alexis, *Pratique industrielle des plans d'expérience*. (AFNOR, 1995)
- [10] E. Parizet, N. Hamzaoui, G. Sabatié, 'Comparison of listening test methods : a case study'. CFA-DAGA Proceedings, Strasbourg (2004).
- [11] M.R. Spiegel, *Theory and problems of statistics*. (McGrow-Hill, 1993)
- [12] W. Aures, *Acustica*, 'Ein Berechnungsverfahren der Rauigkeit', **58**, n°5, 268-81, (1985).
- [13] W.M. Rand, *Journal of the American Statistical Association*, 'Objective criteria for the evaluation of clustering methods', **66**, 846-850, (1971).
- [14] L. Hubert, P. Arabie, *Journal of Classification*, 'Comparing partitions', **2**, 193-218, (1985).
- [15] T.F. Cox, M.A.A. Cox, *Multidimensional Scaling*. (Chapman & Hall, 2001)