



HAL
open science

Force and stiffness of passive magnetic bearings using permanent magnets. Part2: Radial Magnetization.

Romain Ravaud, Guy Lemarquand, Valérie Lemarquand

► To cite this version:

Romain Ravaud, Guy Lemarquand, Valérie Lemarquand. Force and stiffness of passive magnetic bearings using permanent magnets. Part2: Radial Magnetization.. IEEE Transactions on Magnetics, 2009, 45 (9), pp.3334. 10.1109/TMAG.2009.2025315 . hal-00413094

HAL Id: hal-00413094

<https://hal.science/hal-00413094>

Submitted on 3 Sep 2009

HAL is a multi-disciplinary open access archive for the deposit and dissemination of scientific research documents, whether they are published or not. The documents may come from teaching and research institutions in France or abroad, or from public or private research centers.

L'archive ouverte pluridisciplinaire **HAL**, est destinée au dépôt et à la diffusion de documents scientifiques de niveau recherche, publiés ou non, émanant des établissements d'enseignement et de recherche français ou étrangers, des laboratoires publics ou privés.

Force and Stiffness of Passive Magnetic Bearings Using Permanent Magnets.

Part 2 : Radial Magnetization

R. Ravaud, G. Lemarquand *Senior IEEE* and V. Lemarquand

Abstract

This paper deals with the calculation of the force and the stiffness between two ring permanent magnets whose polarization is radial. Such a configuration corresponds to a passive magnetic bearing. The magnetic force exerted between ring permanent magnets is determined by using the coulombian model. The expressions obtained are semi-analytical and we show that it is not possible to find an exact analytical expression of the force between two ring permanent magnets. Then, thanks to these semi-analytical calculations, the ring dimensions are optimized in order to have a great force or a great stiffness. Moreover, we show that the relative position of the rings for which the force is the strongest depends on the air gap dimension. This result is new because the curvature effect is taken into account in this paper. We can say that such semi-analytical expressions are more precise than the numerical evaluation of the magnetic forces obtained with the finite element method. Moreover, semi-analytical expressions have a low computational cost whereas the finite element method has a high one. Thereby, as shown in this paper, such calculations allow an easy optimization of quadripolar lenses or devices using permanent magnets.

Index Terms

Magnetic forces, analytical calculation, ring permanent magnet, magnetic bearing

I. INTRODUCTION

The first studies concerning passive magnetic bearings with permanent magnets have been done by Yonnet [1][2]. Such passive magnetic bearings used only permanent magnets radially or axially magnetized.

Manuscript Received September 26,2008, first revision october 15, second revision january 20,2009.

The authors are with the Laboratoire d'Acoustique de l'Universite du Maine UMR CNRS 6613, Avenue Olivier Messiaen, 72085 Le Mans Cedex 9, France, corresponding author guy.lemarquand@ieee.org

Permanent magnets are commonly used in many electrical devices and engineering applications. Most engineering applications need several ring permanent magnets and the determination of the magnetic force between them is thus required. It is to be noted that several way of obtaining the magnetic forces between rings are possible. Authors generally use either numerical means or 2D analytical calculations for determining magnetic fields or magnetic forces created between ring permanent magnets [3]-[5]. One of the major problem of a numerical approach lies in the fact that it has a high computational cost. Moreover, numerical algorithms are not so precise as analytical calculations. Alternative solutions are thus required. As it is difficult to obtain fully analytical expressions of the magnetic field created by ring permanent magnets [6]-[11], the determination of the forces between them is still more difficult. Consequently, authors use semi-analytical expressions which are very important steps in order to evaluate either the magnetic field created by ring permanent magnets or the magnetic forces exerted between them. The determination of the magnetic field created by ring permanent magnets have been studied a lot with such approaches [12]-[20].

Another way of calculating the forces between ring permanent magnets can be done by using the 2D analytical expressions of the magnetic field created by infinite parallelepipedic magnets. Assuming that the magnetic field created by ring permanent magnets can be approximated by the magnetic field created by infinite parallelepipedic magnets either to the faces of the magnets (2D analytical approach) [21]-[24], the magnetic forces can be calculated more easily with the 2D analytical approach.

However, these formula are not valid when the ring radius is small [25]-[28]. In any case, the magnetic field created by ring permanent magnets can be determined in terms of elliptic integrals [29] for ring permanent magnets axially magnetized. Such an approach is appropriate because the algorithms used to calculate elliptic integrals are both very robust and fast. Consequently, the expressions obtained have a very low computational cost (less than 0.2 s to determine the magnetic components of the field created by ring permanent magnets whose polarization is axial).

First, this paper presents useful semi-analytical expressions of the force and the stiffness exerted between two ring permanent magnets whose polarization is radial. Then, this paper explains why we cannot reduce some numerical integrations of the semi-analytical expressions of the force between two ring permanent magnets. Eventually, this paper deals with the optimization of the ring dimensions in order to have either a great force or a great stiffness between the rings. We show that the relative position between the rings is of great importance in the design of devices using ring permanent magnets. All the expressions determined

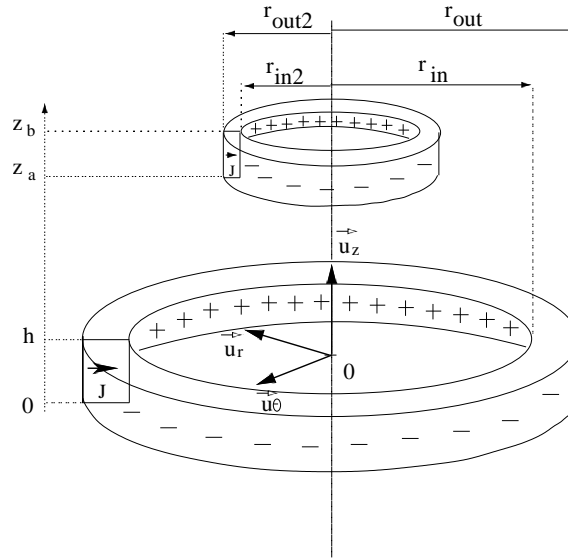

Fig. 1. Representation of the two ring permanent magnets which are radially centered. The inner radius of the outer ring is denoted r_{in} , the outer one is r_{out} , its height is h . The inner radius of the inner ring is denoted r_{in2} , the outer one is r_{out2} , its height is $z_b - z_a$.

in this paper are available online [30].

II. CALCULATION OF THE AXIAL FORCE BETWEEN TWO RING PERMANENT MAGNETS WHOSE POLARIZATION IS RADIAL

This section presents a semi-analytical calculation of the force exerted between two ring permanent magnets whose polarization is radial and which are radially centered. Such configuration corresponds to an axial passive magnetic bearing using ring magnets radially magnetized for mutual attraction. We can say that the devices realized with ring permanent magnets radially magnetized were the first to be built. Moreover, they are usually made of several sections which are stacked together.

A. Notation and geometry

The geometry considered is shown in Fig 1. A two dimensional representation of the passive magnetic bearing is shown in Fig 2.

The outer radius of the outer ring is r_{out} and the inner one is r_{in} . The outer ring height is h . The outer radius of the inner ring is r_{out2} and the inner one is r_{in2} . The inner ring height is $z_b - z_a$. It is to be noted

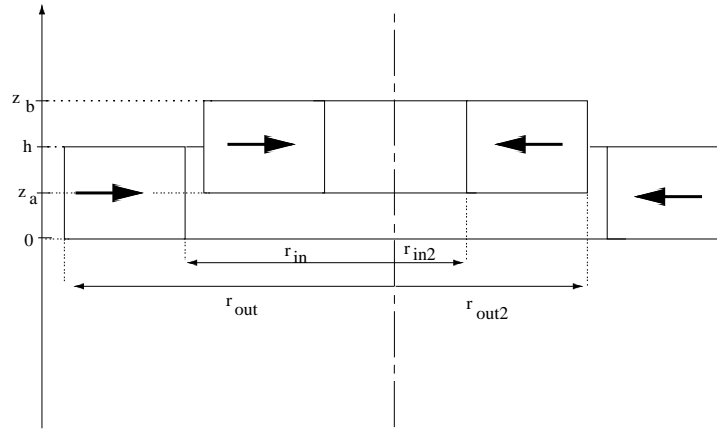

Fig. 2. Radial magnetic bearing using magnets radially magnetized for mutual attraction. The inner radius of the outer ring is denoted r_{in} , the outer one is r_{out} , its height is h . The inner radius of the inner ring is denoted r_{in2} , the outer one is r_{out2} , its height is $z_b - z_a$.

that the coulombian model of a permanent magnet is used. Consequently, each ring permanent magnet is represented by both two curved planes which correspond to the inner and outer faces of the rings which are charged with a surface magnetic pole density σ^* and a magnetic pole volume density σ_v^* . For each case, the inner face is charged with the surface magnetic pole density $+\sigma^*$ and the outer one is charged with the surface magnetic pole density $-\sigma^*$. It is noted that all the illustrative calculations are done with $\sigma^* = \vec{J} \cdot \vec{n} = 1T$ where \vec{J} is the magnetic polarization vector and \vec{n} is the unit normal vector which is directed towards 0. Moreover, it is noted that the magnetic pole volume density exists for ring permanent magnets whose polarization is radial in order to have a charge equilibrium of the ring magnet.

B. Semi-analytical expression of the magnetic force

The two ring permanent magnets which form an axial passive bearing are supposed to be radially centered. Consequently, there is only the axial component of the magnetic force which is exerted between the two rings. We can call it the axial force F_z . This axial force can be determined by integrating the magnetic field created by the outer ring on the contributions of the inner one. We must take into account both the magnetic pole surface density and the magnetic pole volume density of each ring. Consequently, as there are two magnetic pole surface densities and one magnetic pole volume density for each ring permanent magnet, we have nine terms for determining the axial force between the two ring permanent magnets. By denoting H_z the axial component of the magnetic field produced by the outer ring permanent

magnet,

Thus, this axial force F_z can be written as follows:

$$F_z = \int \int_{(S_{in})} H_z \sigma_2^* d\tilde{S} - \int \int_{(S_{out})} H_z \sigma_2^* d\tilde{S} + \int \int \int_{(V)} H_z \frac{\sigma_2^*}{r_2} d\tilde{V} \quad (1)$$

where σ_2^* is the magnetic pole surface density owing to the inner ring permanent magnet, (S_{in}) is the inner face of the inner ring permanent magnet and (S_{out}) is the outer face of the inner ring permanent magnet and (V) is the volume of the inner ring permanent magnet. Therefore, the axial force F_z can be expressed as follows:

$$\begin{aligned} F_z = & - \int_{\theta_1=0}^{2\pi} \int_{z_1=0}^h \int_{\theta_2=0}^{2\pi} \int_{z_2=z_a}^{z_b} a(r_{in}, r_{out2}) dz_1 d\theta_1 dz_2 d\theta_2 \\ & + \int_{\theta_1=0}^{2\pi} \int_{z_1=0}^h \int_{\theta_2=0}^{2\pi} \int_{z_2=z_a}^{z_b} a(r_{out}, r_{out2}) dz_1 d\theta_1 dz_2 d\theta_2 \\ & + \int_{\theta_1=0}^{2\pi} \int_{z_1=0}^h \int_{\theta_2=0}^{2\pi} \int_{z_2=z_a}^{z_b} a(r_{in}, r_{in2}) dz_1 d\theta_1 dz_2 d\theta_2 \\ & - \int_{\theta_1=0}^{2\pi} \int_{z_1=0}^h \int_{\theta_2=0}^{2\pi} \int_{z_2=z_a}^{z_b} a(r_{out}, r_{in2}) dz_1 d\theta_1 dz_2 d\theta_2 \\ & - \int_{r_1=r_{in}}^{r_{out}} \int_{\theta_1=0}^{2\pi} \int_{z_1=0}^h \int_{\theta_2=0}^{2\pi} \int_{z_2=z_a}^{z_b} b(r_{out2}, r_1) dr_1 dz_1 d\theta_1 dz_2 d\theta_2 \\ & + \int_{r_1=r_{in}}^{r_{out}} \int_{\theta_1=0}^{2\pi} \int_{z_1=0}^h \int_{\theta_2=0}^{2\pi} \int_{z_2=z_a}^{z_b} b(r_{in2}, r_1) dr_1 dz_1 d\theta_1 dz_2 d\theta_2 \\ & + \int_{r_2=r_{in2}}^{r_{out2}} \int_{\theta_1=0}^{2\pi} \int_{z_1=0}^h \int_{\theta_2=0}^{2\pi} \int_{z_2=z_a}^{z_b} b(r_{in}, r_2) dz_1 d\theta_1 dr_2 dz_2 d\theta_2 \\ & - \int_{r_2=r_{in2}}^{r_{out2}} \int_{\theta_1=0}^{2\pi} \int_{z_1=0}^h \int_{\theta_2=0}^{2\pi} \int_{z_2=z_a}^{z_b} b(r_{out}, r_2) dz_1 d\theta_1 dr_2 dz_2 d\theta_2 \\ & + \int_{r_1=r_{in}}^{r_{out}} \int_{r_2=r_{in2}}^{r_{out2}} \int_{\theta_1=0}^{2\pi} \int_{z_1=0}^h \int_{\theta_2=0}^{2\pi} \int_{z_2=z_a}^{z_b} c(r_1, r_2) dr_1 dz_1 d\theta_1 dr_2 dz_2 d\theta_2 \end{aligned} \quad (2)$$

with

$$a(\alpha, \beta) = \frac{\sigma_1^* \sigma_2^*}{4\pi\mu_0} \frac{(z_2 - z_1)\alpha\beta}{(\alpha^2 + \beta^2 - 2\alpha\beta + (z_2 - z_1)^2)^{\frac{3}{2}}} \quad (3)$$

where σ_1^* is the magnetic pole surface density owing to the inner ring permanent magnet. and

$$b(\alpha, \beta) = \frac{a(\alpha, \beta)}{\beta} \quad (4)$$

$$c(\alpha, \beta) = \frac{a(\alpha, \beta)}{\alpha\beta} \quad (5)$$

The next step is to evaluate (2). If we determined directly F_z for given values with all the integrals presented in (2), the computational would be too high because several numerical integrals should be determined at a time. Consequently, we must reduce the number of integrals by integrating analytically $a(\alpha, \beta)$, $b(\alpha, \beta)$ and $c(\alpha, \beta)$ according to the integral variables. Unfortunately, it is not possible to find a fully analytical expression of the magnetic force between two ring permanent magnets but we can use a useful semi-analytical expression which is expressed as follows:

$$\begin{aligned}
 F_z = & \frac{\sigma_1^* \sigma_2^*}{2\mu_0} \int_{\theta_1=0}^{2\pi} S d\theta_1 \\
 & + \frac{\sigma_1^* \sigma_2^*}{2\mu_0} \int_{\theta_1=0}^{2\pi} M d\theta_1 \\
 & + \frac{\sigma_1^* \sigma_2^*}{2\mu_0} \int_{\theta_1=0}^{2\pi} \int_{r_2=r_{in2}}^{r_{out2}} V d\theta_1 dr_2
 \end{aligned} \tag{6}$$

where S corresponds to the magnetic interaction between the magnetic pole surface densities of each ring permanent magnet. Then, M corresponds to the magnetic interaction between the magnetic pole surface densities of one ring permanent magnet and the magnetic pole volume density of the other one. At least, V corresponds to the magnetic interaction between the magnetic pole volume densities of each ring permanent magnet.

The first contribution S is given by (7).

$$\begin{aligned}
 S = & -f(z_a, z_b, h, \theta_1, r_{in}, r_{out2}) \\
 & + f(z_a, z_b, h, \theta_1, r_{out}, r_{out2}) \\
 & + f(z_a, z_b, h, \theta_1, r_{in}, r_{in2}) \\
 & - f(z_a, z_b, h, \theta_1, r_{out}, r_{in2})
 \end{aligned} \tag{7}$$

with

$$\begin{aligned}
 f(\alpha_1, \alpha_2, \alpha_3, \theta_1, \alpha_5, \alpha_6) = & \alpha_5 \alpha_6 \log \left[\alpha_3 - \alpha_1 + \sqrt{\alpha_5^2 + \alpha_6^2 + (\alpha_3 - \alpha_1)^2 - 2\alpha_5 \alpha_6 \cos(\theta_1)} \right] \\
 & + \alpha_5 \alpha_6 \log \left[\alpha_1 + \sqrt{\alpha_5^2 + \alpha_6^2 + \alpha_1^2 - 2\alpha_5 \alpha_6 \cos(\theta_1)} \right] \\
 & - \alpha_5 \alpha_6 \log \left[\alpha_3 - \alpha_2 + \sqrt{\alpha_5^2 + \alpha_6^2 + (\alpha_3 - \alpha_2)^2 - 2\alpha_5 \alpha_6 \cos(\theta_1)} \right]
 \end{aligned}$$

$$-\alpha_5\alpha_6 \log \left[\alpha_2 + \sqrt{\alpha_5^2 + \alpha_6^2 + \alpha_2^2 - 2\alpha_5\alpha_6 \cos(\theta_1)} \right] \quad (8)$$

The second contribution M is given by (9).

$$\begin{aligned} M = & -t(r_{in}, r_{out}, r_{out2}, h, z_a, z_b, \theta_1) \\ & +t(r_{in}, r_{out}, r_{in2}, h, z_a, z_b, \theta_1) \\ & +t(r_{in}, r_{out}, r_{in}, h, z_a, z_b, \theta_1) \\ & -t(r_{in}, r_{out}, r_{out}, h, z_a, z_b, \theta_1) \end{aligned} \quad (9)$$

with

$$\begin{aligned} t(\beta_1, \beta_2, \beta_3, \beta_4, \beta_5, \beta_6, \theta_1) = & t^{(2)}(\beta_1, \beta_2, \beta_4 - \beta_5, \beta_3^2 + (\beta_4 - \beta_5)^2, 2\beta_3 \cos(\theta_1)) \\ & +t^{(2)}(\beta_1, \beta_2, \beta_5, \beta_3^2 + \beta_5^2, 2\beta_3 \cos(\theta_1)) \\ & -t^{(2)}(\beta_1, \beta_2, \beta_4 - \beta_6, \beta_3^2 + (\beta_4 - \beta_6)^2, 2\beta_3 \cos(\theta_1)) \\ & -t^{(2)}(\beta_1, \beta_2, \beta_6, \beta_3^2 + \beta_6^2, 2\beta_3 \cos(\theta_1)) \end{aligned} \quad (10)$$

and

$$t^{(2)}(\beta_1, \beta_2, q, d, f) = t^{(3)}(\beta_2, q, d, f) - t^{(3)}(\beta_1, q, d, f) \quad (11)$$

and

$$\begin{aligned} t^{(3)}(s, q, d, f) = & -s + \frac{\sqrt{4d - f^2 - 4q^2}}{2} \arctan \left[\frac{-f + 2s}{\sqrt{4d - f^2 - 4q^2}} \right] - \frac{f}{4} \log [d - q^2 - fs + s^2] \\ & +s \log [q + \sqrt{d - fs + s^2}] + q \log [-f + 2(s + \sqrt{d - fs + s^2})] \\ & - \frac{(4d - f^2 - 4q^2 + f\eta) \log [u_1]}{4\eta} \\ & - \frac{(-4d + f^2 + 4q^2 + f\eta) \log [u_2]}{4\eta} \end{aligned} \quad (12)$$

$$u_1 = -\frac{2(f^2 + 4fq^2 - f^2(\eta + 2s) + 4d(-f + \eta + 2s))}{q^2(-4d + f^2 + 4q^2 - f\eta)(-f + \eta + 2s)} - \frac{8q(-2qs + \eta\sqrt{d - fs + s^2})}{q^2(-4d + f^2 + 4q^2 - f\eta)(-f + \eta + 2s)} \quad (13)$$

$$u_2 = -\frac{2(f^2 + 4fq^2 - f^2(\eta - 2s) - 4d(f + \eta - 2s))}{q^2(-4d + f^2 + 4q^2 + f\eta)(f + \eta - 2s)} - \frac{-8q(2qs + \eta\sqrt{d - fs + s^2})}{q^2(-4d + f^2 + 4q^2 + f\eta)(f + \eta - 2s)} \quad (14)$$

with

$$\eta = \sqrt{-4d + f^2 + 4q^2} \quad (15)$$

The third contribution V is given by (16).

$$V = th^{(1)}(r_{out}, r_2, z_a, z_b, h, \theta_1) - th^{(1)}(r_{in}, r_2, z_a, z_b, h, \theta_1) \quad (16)$$

with

$$\begin{aligned} th^{(1)} &= t^{(3)}(r_1, h - z_a, r_2^2 + (h - z_a)^2, 2r_2 \cos(\theta_1)) \\ &\quad + t^{(3)}(r_1, z_a, r_2^2 + z_a^2, 2r_2 \cos(\theta_1)) \\ &\quad - t^{(3)}(r_1, h - z_b, r_2^2 + (h - z_b)^2, 2r_2 \cos(\theta_1)) \\ &\quad - t^{(3)}(r_1, z_b, r_2^2 + z_b^2, 2r_2 \cos(\theta_1)) \end{aligned} \quad (17)$$

C. Expression of the axial stiffness between two rings whose polarization is radial

The stiffness K exerted between two ring permanent magnets can be determined by calculating the derivative of the axial force with respect to z_a . We set $z_b = z_a + b$ where b is the height of the inner ring permanent magnet. Thus, the axial stiffness K can be calculated with (18).

$$K = -\frac{\partial}{\partial z_a} F_z \quad (18)$$

where F_z is given by (2). We obtain :

$$K = K_S + K_M + K_V \quad (19)$$

where K_S corresponds to the stiffness determined with only the magnetic pole surface densities of each ring permanent magnet. Then, K_M corresponds to the stiffness determined with the magnetic interaction between the magnetic pole surface densities of one ring permanent magnet and the magnetic pole volume density of the other one. At least, K_V corresponds to the stiffness determined with the magnetic interaction between the magnetic pole volume densities of each ring permanent magnet. Thus, the first contribution K_S is expressed as follows:

$$\begin{aligned}
K_S = & \eta_{31} \left(\frac{1}{\sqrt{\alpha_{31}}} \mathbf{K}^* \left[-\frac{4r_3r_1}{\alpha_{31}} \right] - \frac{1}{\sqrt{\beta_{31}}} \mathbf{K}^* \left[-\frac{4r_3r_1}{\beta_{31}} \right] + \frac{1}{\sqrt{\delta_{31}}} \mathbf{K}^* \left[-\frac{4r_3r_1}{\delta_{31}} \right] - \frac{1}{\sqrt{\gamma_{31}}} \mathbf{K}^* \left[-\frac{4r_3r_1}{\gamma_{31}} \right] \right) \\
& + \eta_{41} \left(\frac{1}{\sqrt{\alpha_{41}}} \mathbf{K}^* \left[-\frac{4r_4r_1}{\alpha_{41}} \right] - \frac{1}{\sqrt{\beta_{41}}} \mathbf{K}^* \left[-\frac{4r_4r_1}{\beta_{41}} \right] + \frac{1}{\sqrt{\delta_{41}}} \mathbf{K}^* \left[-\frac{4r_4r_1}{\delta_{41}} \right] - \frac{1}{\sqrt{\gamma_{41}}} \mathbf{K}^* \left[-\frac{4r_4r_1}{\gamma_{41}} \right] \right) \\
& + \eta_{32} \left(\frac{1}{\sqrt{\alpha_{32}}} \mathbf{K}^* \left[-\frac{4r_3r_2}{\alpha_{32}} \right] - \frac{1}{\sqrt{\beta_{32}}} \mathbf{K}^* \left[-\frac{4r_3r_2}{\beta_{32}} \right] + \frac{1}{\sqrt{\delta_{32}}} \mathbf{K}^* \left[-\frac{4r_3r_2}{\delta_{32}} \right] - \frac{1}{\sqrt{\gamma_{32}}} \mathbf{K}^* \left[-\frac{4r_3r_2}{\gamma_{32}} \right] \right) \\
& + \eta_{42} \left(\frac{1}{\sqrt{\alpha_{42}}} \mathbf{K}^* \left[-\frac{4r_4r_2}{\alpha_{42}} \right] - \frac{1}{\sqrt{\beta_{42}}} \mathbf{K}^* \left[-\frac{4r_4r_2}{\beta_{42}} \right] + \frac{1}{\sqrt{\delta_{42}}} \mathbf{K}^* \left[-\frac{4r_4r_2}{\delta_{42}} \right] - \frac{1}{\sqrt{\gamma_{42}}} \mathbf{K}^* \left[-\frac{4r_4r_2}{\gamma_{42}} \right] \right)
\end{aligned} \tag{20}$$

with

$$\eta_{ij} = \frac{2r_i r_j \sigma^*}{\mu_0} \tag{21}$$

$$\alpha_{ij} = (r_i - r_j)^2 + z_a^2 \tag{22}$$

$$\beta_{ij} = (r_i - r_j)^2 + (z_a + h)^2 \tag{23}$$

$$\gamma_{ij} = (r_i - r_j)^2 + (z_a - h)^2 \tag{24}$$

$$\delta_{ij} = (r_i - r_j)^2 + (b - h)^2 + z_a(2b - 2h + z_a) \tag{25}$$

$$\mathbf{K}^* [m] = \int_0^{\frac{\pi}{2}} \frac{1}{\sqrt{1 - m \sin^2(\theta)}} d\theta \tag{26}$$

The second contribution K_M is expressed as follows:

$$K_M = \frac{\sigma_1^* \sigma_2^*}{2\mu_0} \int_{\theta=0}^{2\pi} u d\theta \tag{27}$$

with

$$\begin{aligned}
u &= f(r_{in}, r_{out}, r_{in2}, h, z_a, b, \theta) \\
&\quad - f(r_{in}, r_{out}, r_{out2}, h, z_a, b, \theta) \\
&\quad + f(r_{in2}, r_{out2}, r_{in}, h, z_a, b, \theta) \\
&\quad - f(r_{in2}, r_{out2}, r_{out}, h, z_a, b, \theta)
\end{aligned} \tag{28}$$

and

$$\begin{aligned}
f(\alpha, \beta, \gamma, h, z_a, b, \theta) &= -\gamma \log \left[\alpha - \gamma \cos(\theta) + \sqrt{\alpha^2 + \gamma^2 + z_a^2 - 2\alpha\gamma \cos(\theta)} \right] \\
&\quad + \gamma \log \left[\alpha - \gamma \cos(\theta) + \sqrt{\alpha^2 + \gamma^2 + (z_a + b)^2 - 2\alpha\gamma \cos(\theta)} \right] \\
&\quad + \gamma \log \left[\alpha - \gamma \cos(\theta) + \sqrt{\alpha^2 + \gamma^2 + (z_a - h)^2 - 2\alpha\gamma \cos(\theta)} \right] \\
&\quad - \gamma \log \left[\alpha - \gamma \cos(\theta) + \sqrt{\alpha^2 + \gamma^2 + (b - h)^2 + 2z_a(b - h) + z_a^2 - 2\alpha\gamma \cos(\theta)} \right] \\
&\quad + \gamma \log \left[\beta - \gamma \cos(\theta) + \sqrt{\beta^2 + \gamma^2 + z_a^2 - 2\alpha\gamma \cos(\theta)} \right] \\
&\quad - \gamma \log \left[\beta - \gamma \cos(\theta) + \sqrt{\beta^2 + \gamma^2 + (z_a + b)^2 - 2\alpha\gamma \cos(\theta)} \right] \\
&\quad + \gamma \log \left[\beta - \gamma \cos(\theta) + \sqrt{\beta^2 + \gamma^2 + (z_a - h)^2 - 2\alpha\gamma \cos(\theta)} \right] \\
&\quad - \gamma \log \left[\beta - \gamma \cos(\theta) + \sqrt{\beta^2 + \gamma^2 + (b - h)^2 + 2z_a(b - h) + z_a^2 - 2\alpha\gamma \cos(\theta)} \right]
\end{aligned} \tag{29}$$

The third contribution K_V is expressed as follows:

$$K_V = \frac{\sigma_1^* \sigma_2^*}{2\mu_0} \int_{\theta=0}^{2\pi} \int_{r_1=r_{in}}^{r_{out}} \delta d\theta \tag{30}$$

with

$$\begin{aligned}
\delta &= -\log \left[r_{in2} - r_1 \cos(\theta) + \sqrt{r_1^2 + r_{in2}^2 + z_a^2 - 2r_1 r_{in2} \cos(\theta)} \right] \\
&\quad + \log \left[r_{in2} - r_1 \cos(\theta) + \sqrt{r_1^2 + r_{in2}^2 + (z_a + b)^2 - 2r_1 r_{in2} \cos(\theta)} \right] \\
&\quad - \log \left[r_{in2} - r_1 \cos(\theta) + \sqrt{r_1^2 + r_{in2}^2 + (b - h)^2 + 2bz_a - 2hz_a + z_a^2 - 2r_1 r_{in2} \cos(\theta)} \right] \\
&\quad + \log \left[r_{in2} - r_1 \cos(\theta) + \sqrt{r_1^2 + r_{in2}^2 + (z_a - h)^2 - 2r_1 r_{in2} \cos(\theta)} \right] \\
&\quad + \log \left[r_{out2} - r_1 \cos(\theta) + \sqrt{r_1^2 + r_{out2}^2 + z_a^2 - 2r_1 r_{out2} \cos(\theta)} \right]
\end{aligned}$$

$$\begin{aligned}
& -\log \left[r_{out2} - r_1 \cos(\theta) + \sqrt{r_1^2 + r_{out2}^2 + (z_a + b)^2 - 2r_1 r_{out2} \cos(\theta)} \right] \\
& -\log \left[r_{out2} - r_1 \cos(\theta) + \sqrt{r_1^2 + r_{out2}^2 + (z_a - h)^2 - 2r_1 r_{out2} \cos(\theta)} \right] \\
& +\log \left[r_{out2} - r_1 \cos(\theta) + \sqrt{r_1^2 + r_{out2}^2 + (b - h)^2 + 2bz_a - 2hz_a + z_a^2 - 2r_1 r_{out2} \cos(\theta)} \right]
\end{aligned} \tag{31}$$

We can say that the expression of the axial stiffness can be determined analytically if we only take into account the magnetic pole surface densities of each ring.

III. DISCUSSION ABOUT THE POSSIBILITY OF REDUCING THE NUMBER OF NUMERICAL INTEGRATIONS FOR THE AXIAL FORCE EXPRESSION

The aim of this section is to explain why we cannot reduce the number of numerical integrations of the semi-analytical expression of the force exerted between two ring permanent magnets radially magnetized. They correspond physically to three kinds of interactions between two ring permanent magnets whose polarization is radial.

A. Interaction between the contributions of the surface densities

The first kind of physical interaction is due to the surface contributions of each ring permanent magnet. This physical interaction corresponds to the case when the surface densities of the outer ring are integrated with the surface densities of the inner one. In Eq. (2), these surface contributions correspond to the integrand denoted $a(\alpha, \beta)$ where α and β can be r_{in} , r_{out} , r_{in2} and r_{out2} . Let us consider the integrand $a(\alpha, \beta)$. As we can see in Eq. (2), the integration variables depend on θ_1 , θ_2 , z_1 and z_2 . The integration according θ_2 does not change the form of the integrand $a(\alpha, \beta)$ because $a(\alpha, \beta)$ does not depend on θ_2 . Consequently, we can say that the form of the force F_s between the surface density contributions of each ring permanent magnet is given as follows :

$$F_s = \int_{\theta_1} \int_{z_1} \int_{z_2} \frac{a_1(z_2 - z_1)}{(a_2 - a_3 \cos(\theta_1) + (z_2 - z_1)^2)^{\frac{3}{2}}} d\theta_1 dz_1 dz_2 \tag{32}$$

where a_1 , a_2 and a_3 are constant. For example, we can have $a_1 = 2\pi(h - z_a)$, $a_2 = 2\pi(r_{in}^2 + r_{out}^2 + (h - z_a)^2)$ and $a_3 = 2\pi(-2r_{in}r_{out2})$ for our illustration here. In short, these parameters are given by (2) and correspond to the case when four integrals must be determined.

After having integrated according z_1 and z_2 , we obtain a semi-analytical expression with only one numerical integration whose variable depends on θ_1 :

$$F_s = \int_{\theta_1} \log \left(a_4 + \sqrt{a_5 + a_6 \cos(\theta_1)} \right) d\theta_1 \quad (33)$$

These parameters are given by (8) and they are not a function of the angle θ . It is to be noted that (33) cannot be integrated analytically.

B. Interaction between the contributions of the surface and volume densities

The second kind of physical interaction is due to both the surface and the volume contributions of each ring permanent magnet. This physical interaction corresponds to the case when the surface densities of each ring permanent magnet are integrated with the volume densities of the other ones. In Eq. (2), these surface contributions correspond to the integrand denoted $b(\alpha, \beta)$ where α and β can be r_{in} , r_{out} , r_{in2} , r_{out2} , r_1 and r_2 . Let us consider the integrand $b(\alpha, \beta)$. As we can see in Eq. (2), the integration variables depend on θ_1 , θ_2 , z_1 , z_2 , r_1 and r_2 . The integration according θ_2 does not change the form of the integrand $b(\alpha, \beta)$ because $b(\alpha, \beta)$ does not depend on θ_2 . Consequently, we can say that the form of the force F_{vs} between the surface density contributions and the volume density contributions of each ring permanent magnet is given as follows :

$$F_{vs} = \int_{\theta_1} \int_{r_i} \int_{z_1} \int_{z_2} \frac{b_1(z_2 - z_1)}{(b_2 - b_3 \cos(\theta_1) + (z_2 - z_1)^2)^{\frac{3}{2}}} d\theta_1 dz_1 dz_2 dr_i \quad (34)$$

where b_1 , b_2 and b_3 are constant. These parameters are given by (2) and correspond to the case when five integrals must be determined.

After having integrated according z_1 , z_2 and r_1 , we obtain a semi-analytical expression with only one numerical integration whose variable depends on θ_1 : this semi-analytical expression is in fact given by (33) where s depends on θ_1 . We see that (34) owns a term which has the same form as the one presented in Eq.(33). Consequently, it cannot be integrated analytically as well.

C. Interaction between the contributions of the volume densities

The third kind of physical interaction is due to the volume contributions of each ring permanent magnet. This physical interaction corresponds to the case when the volume densities of each ring permanent magnet are integrated together. In Eq. (2), this volume contribution correspond to the integrand denoted $c(\alpha, \beta)$

where α and β can be r_1 or r_2 . Let us consider the integrand $c(\alpha, \beta)$. As we can see in Eq. (2), the integration variables depend on $\theta_1, \theta_2, z_1, z_2, r_1$ and r_2 . The integration according θ_2 does not change the form of the integrand $c(\alpha, \beta)$ because $c(\alpha, \beta)$ does not depend on θ_2 . Consequently, we can say that the form of the force F_v between the volume density contributions is given as follows :

$$F_v = \int_{\theta_1} \int_{r_1} \int_{r_2} \int_{z_1} \int_{z_2} \frac{(z_2 - z_1)}{(c_1 - c_2 \cos(\theta_1) + (z_2 - z_1)^2)^{\frac{3}{2}}} d\theta_1 dz_1 dz_2 dr_1 dr_2 \quad (35)$$

where c_1 and c_2 are constant. These parameters are given by (2) and correspond to the case when six integrals must be determined.

After having integrated according z_1, z_2 and r_1 , we obtain the same integrand as the one obtained previously in the case of the study of the force exerted between the surface and volume charge contributions. Consequently, we deduct that we cannot integrate analytically F_v according to θ_1 . Moreover, the analytical integration according to r_2 does not seem possible. As a conclusion, we can say that the obtaining of a fully analytical expression of the force between two ring permanent magnets whose polarization is radial does not seem possible but a semi-analytical expression can be used to determine this axial force.

IV. OPTIMIZATION OF THE INNER RING PERMANENT MAGNET DIMENSIONS

This section discusses the optimal dimensions of the rings in order to have either a great force or a great stiffness.

A. Influence of the air gap dimension on the force and the stiffness

First, we study the influence of the air gap dimension on the force and the stiffness between the two ring permanent magnets. For this purpose, we represent the axial force versus the axial displacement of the inner ring for different air gaps in Fig. 3. It is noted that, in our configuration, the air gap corresponds to the difference between r_{in} and r_{out2} . Furthermore, the width and the height of each ring permanent magnet are constant. We take $r_{in} = 0.025\text{m}$, $r_{out} = 0.028\text{m}$, $r_{out2} - r_{int2} = 0.003\text{m}$, $J = 1\text{T}$, $h = 0.003\text{m}$, $zb - z_a = 0.003\text{m}$.

Fig. 3 shows three important points.

First, we see that the smaller the air gap between the ring permanent magnets is, the greater the axial force is. Consequently, it is necessary to have the smaller air gap between ring permanent magnets if a great force is searched. This result is well-known. It was shown with the two dimensional approach.

Second, we see that the exact position of the maximal force exerted between two ring permanent magnets

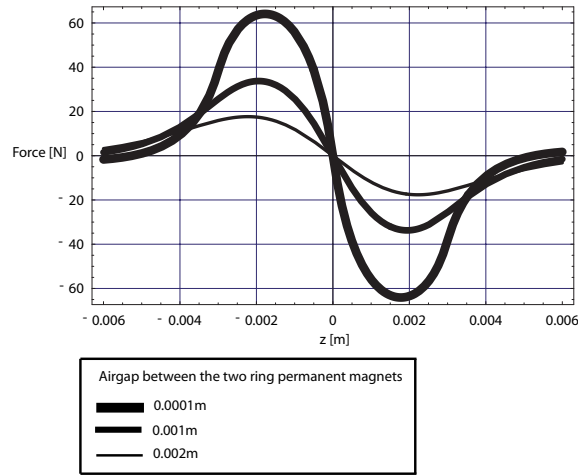

Fig. 3. Representation of the axial component of the magnetic force exerted between two ring permanent magnets versus the axial displacement of the inner ring permanent magnet for different air gaps; $r_{in} = 0.025\text{m}$, $r_{out} = 0.028\text{m}$, $r_{out2} - r_{int2} = 0.003\text{m}$, $J = 1\text{T}$, $h = 0.003\text{m}$, $z_b - z_a = 0.003\text{m}$.

depends slightly on the air gap dimension. This result is new because our study uses a three-dimensional approach of the magnetic force whereas the previous ones used a two-dimensional approach. The magnet curvature must be taken into account in order to obtain precisely the position of the maximal force exerted between two ring magnets. The exact position of the maximal force is represented in Fig 4. Such result is very useful because it clearly shows that if a great axial force is searched, the relative height between the two rings inner ring depends on the air gap dimension.

Eventually, Fig 3 shows that the stiffness depends greatly on the air gap dimension. Fig 3 shows that the smaller the air gap dimension is, the greater the stiffness is because the gradient of the curve is the more important for small air gaps. This result is consistent with the representation of the axial stiffness versus the axial displacement of the inner ring permanent magnet (Fig 5). Indeed, we see that the smaller the air gap dimension is, the greater the axial stiffness is. Moreover, we see that when the axial force is maximal in Fig 3, the axial stiffness equals zero in Fig 5, which is still consistent.

B. Determination of the optimal height of the inner ring permanent magnet

Another parameter which can be optimized is the height of the inner ring permanent magnet. To do so, the axial component of the magnetic force is plotted versus the axial displacement of the inner ring

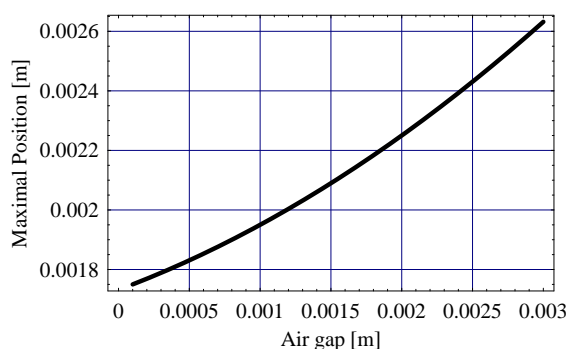

Fig. 4. Representation of the position of the maximal value of the axial force versus the air gap dimension; $r_{in} = 0.025\text{m}$, $r_{out} = 0.028\text{m}$, $r_{out2} - r_{int2} = 0.003\text{m}$, $J = 1\text{T}$, $h = 0.003\text{m}$, $z_b - z_a = 0.003\text{m}$.

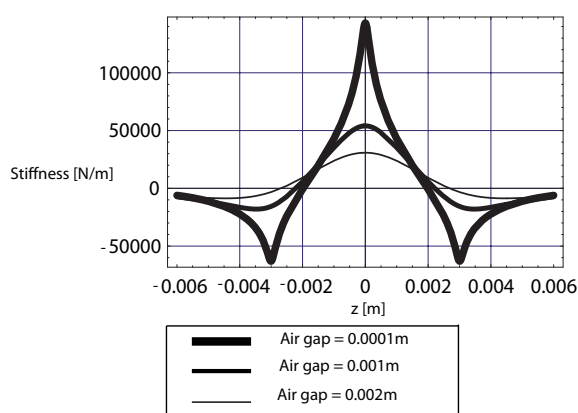

Fig. 5. Representation of the axial stiffness of the magnetic force exerted between two ring permanent magnets versus the axial displacement of the inner ring permanent magnet for different air gaps; $r_{in} = 0.025\text{m}$, $r_{out} = 0.028\text{m}$, $r_{out2} - r_{int2} = 0.003\text{m}$, $J = 1\text{T}$, $h = 0.003\text{m}$, $z_b - z_a = 0.003\text{m}$.

permanent magnet for several inner ring heights in Fig. 6. The values taken for the parameters are still the same as the previous ones. Fig. 6 shows that the axial component of the magnetic force is the greatest if its height equals the outer ring height. Indeed, if the ring inner height is smaller than the ring outer one, the smaller the inner ring width is, the smaller the axial component of the magnetic force is. If the ring inner height is greater than the ring outer one, the greater the inner ring width is, the smaller the axial component of the magnetic force is. Consequently, if a great force is searched, the two ring permanent magnets must have the same height.

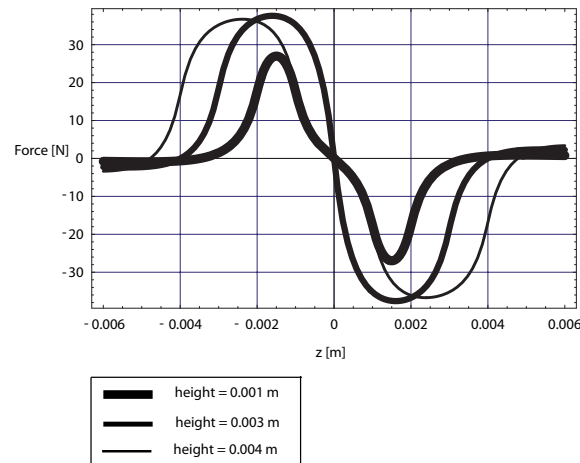

Fig. 6. Representation of the axial component of the magnetic force exerted between two ring permanent magnets versus the axial displacement of the inner ring permanent magnet for different heights; $r_{in} = 0.025\text{m}$, $r_{out} = 0.028\text{m}$, $r_{out2} = 0.0249\text{m}$, $J = 1\text{T}$, $h = 0.003\text{m}$, $z_a = 0\text{m}$.

Furthermore, we see that the gradient of the curves is the more important when the inner ring height is the same as the outer one. This result is consistent with Fig 7 where the axial stiffness is represented versus the axial displacement of the inner ring permanent magnet.

C. Determination of the optimal width of the inner ring permanent magnet

The third parameter which can be optimized in our configuration is the width of the inner ring permanent magnet. To do so, the axial component of the magnetic force is plotted versus the axial displacement of the inner ring permanent magnet for several inner ring widths in Fig. 8. The values taken for the parameters are the same as the previous ones. Fig. 8 shows that the greater the inner ring width is, the greater the axial component of the magnetic force is. However, it is noted that a compromise in the ring dimensions must be found because the cost of the magnet must be taken into account. A good compromise can be found as follows : if the inner ring width equals two times its height, the axial component of the magnetic force is 72N when $z = 0.0015\text{m}$. If the inner ring width equals three times its height, the axial component of the magnetic force is 73N . Consequently, we deduct that it is not necessary to have an inner ring width which is greater than two times its height.

The optimal stiffness depends also on the inner ring width. To see that, we have represented in Fig 9 the axial stiffness versus the inner ring width when $z_a = 0$. Fig 9 shows that the larger the inner ring width

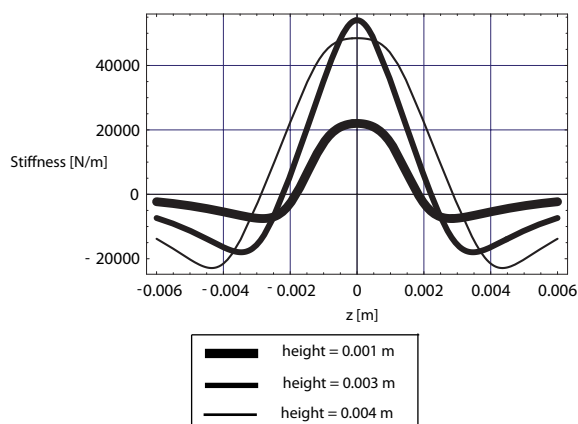

Fig. 7. Representation of the axial component of the magnetic force exerted between two ring permanent magnets versus the axial displacement of the inner ring permanent magnet for different heights; $r_{in} = 0.025\text{m}$, $r_{out} = 0.028\text{m}$, $r_{out2} = 0.0249\text{m}$, $J = 1\text{T}$, $h = 0.003\text{m}$, $z_a = 0\text{m}$.

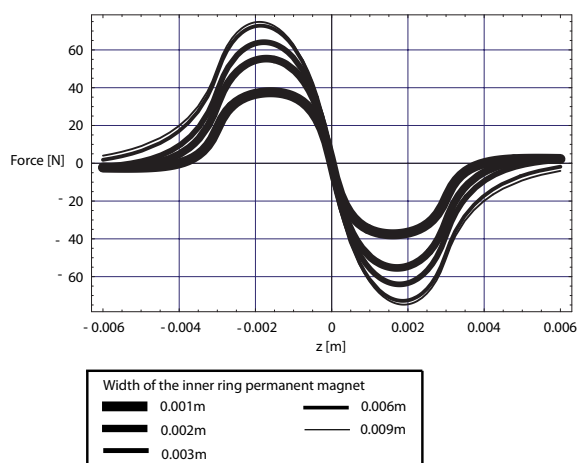

Fig. 8. Representation of the axial component of the magnetic force exerted between two ring permanent magnets versus the axial displacement of the inner ring permanent magnet for different widths; $r_{in} = 0.025\text{m}$, $r_{out} = 0.028\text{m}$, $r_{out2} = 0.0249\text{m}$, $J = 1\text{T}$, $h = 0.003\text{m}$, $z_b - z_a = 0.003\text{m}$.

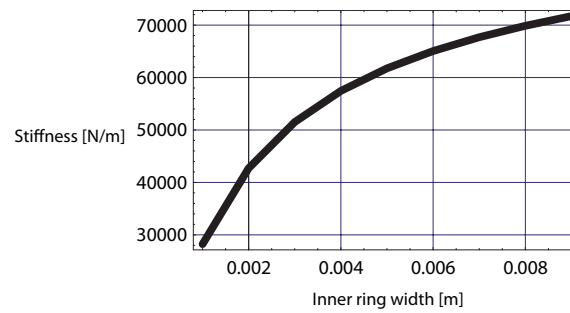

Fig. 9. Representation of the axial stiffness exerted between two ring permanent magnets versus inner ring width $r_{in} = 0.025\text{m}$, $r_{out} = 0.028\text{m}$, $r_{out2} = 0.0249\text{m}$, $J = 1\text{T}$, $h = 0.003\text{m}$, $z_b - z_a = 0.003\text{m}$.

is, the greater the axial stiffness is.

V. OBTAINING THE BEST CONFIGURATION

The previous section shows that the ring dimensions must be optimized in order to create a very good passive magnetic bearing. The air gap must be the smallest, the ring heights must be the same and we have shown that the inner ring width must equal two times its height. All these parameters have been determined with a outer ring whose cross-section is a square. However, we can also optimize the outer ring in order to improve the passive bearing. By taking into account the optimal dimensions found in the previous section, we can compare three configurations. The first one, shown in Fig 10-A, consists of two rings whose cross-section is a square. The second one, shown in Fig 10-B, consists of two rings whose cross-section is a rectangle whose width equals two times its height . The third one, shown in Fig 10-C, consists of two rings whose cross-section is a rectangle whose height equals two times its width. For each structure presented in Fig 10, the axial force and the axial stiffness are determined versus the axial displacement of the inner ring permanent magnet. The axial force is shown in Fig 11 and the axial stiffness is shown in Fig 12.

Figs 11 and 12 show that the best configuration is the configuration B presented in Fig 10. However, the relative height between the two ring permanent magnets depends on the air gap dimension (Fig 4). Consequently, this last parameter must be taken into account in the design of passive bearings using ring permanent magnets.

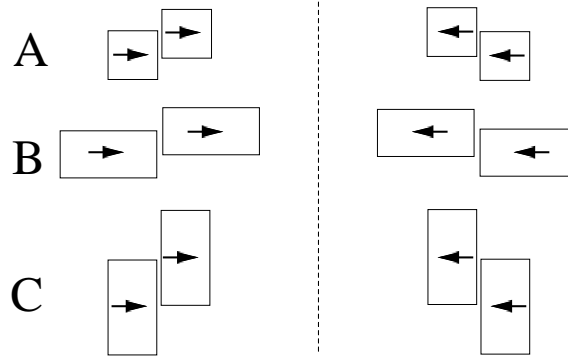

Fig. 10. Representation of three passive magnetic bearings. A = $r_{in} = 0.025\text{m}$, $r_{out} = 0.028\text{m}$, $r_{out2} = 0.0249\text{m}$, $r_{in2} = 0.0219\text{m}$, $h = 0.003\text{m}$, $z_b - z_a = 0.003\text{m}$. B = $r_{in} = 0.025\text{m}$, $r_{out} = 0.031\text{m}$, $r_{out2} = 0.0249\text{m}$, $r_{in2} = 0.0189\text{m}$, $h = 0.003\text{m}$, $z_b - z_a = 0.003\text{m}$. C = $r_{in} = 0.025\text{m}$, $r_{out} = 0.028\text{m}$, $r_{out2} = 0.0249\text{m}$, $r_{in2} = 0.0219\text{m}$, $h = 0.006\text{m}$, $z_b - z_a = 0.006\text{m}$.

VI. CONCLUSION

This paper has presented new three-dimensional semi-analytical expressions allowing us to determine both the axial force and the axial stiffness between two ring permanent magnets whose polarization is radial. This paper also discusses the reason why we cannot find a fully analytical expression of the axial component of the magnetic force. Eventually, we have discussed the optimal dimensions of the ring permanent magnets which allow us to have either a great axial force or a great axial stiffness. We have shown that a good compromise can be found when the cross-section of a ring is a rectangle. However, the relative position of the two rings is not constant but depends on the air gap dimension. Such results can be very useful for people involved in the design of magnetic bearings.

REFERENCES

- [1] J. P. Yonnet, "Passive magnetic bearings with permanent magnets," *IEEE Trans. Magn.*, vol. 14, no. 5, pp. 803–805, 1978.
- [2] J. P. Yonnet, "Permanent magnet bearings and couplings," *IEEE Trans. Magn.*, vol. 17, no. 1, pp. 1169–1173, 1981.
- [3] B. Azzerboni, E. Cardelli, and A. Tellini, "Computation of the magnetic field in massive conductor systems," *IEEE Trans. on Magn.*, vol. 25, no. 6, pp. 4462–4473, 1989.
- [4] E. P. Furlani, S. Reznik, and A. Kroll, "A three-dimensional field solution for radially polarized cylinders," *IEEE Trans. Magn.*, vol. 31, no. 1, pp. 844–851, 1995.
- [5] G. Akoun and J. P. Yonnet, "3d analytical calculation of the forces exerted between two cuboidal magnets," *IEEE Trans. Magn.*, vol. 20, no. 5, pp. 1962–1964, 1984.
- [6] K. Kim, E. Levi, Z. Zabar, and L. Birenbaum, "Mutual inductance of noncoaxial circular coils with constant current density," *IEEE Trans. Magn.*, vol. 33, no. 32, pp. 4303–4309, 1997.

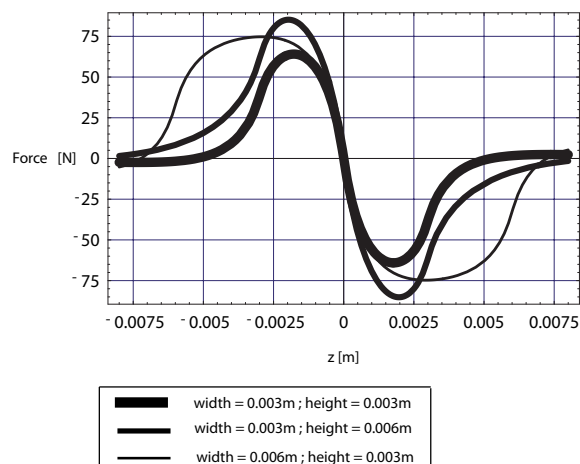

Fig. 11. Representation of the axial force exerted between two ring permanent magnets versus inner ring width $r_{in} = 0.025\text{m}$, $r_{out} = 0.028\text{m}$, $r_{out2} = 0.0249\text{m}$, $J = 1\text{T}$, $h = 0.003\text{m}$, $z_b - z_a = 0.003\text{m}$.

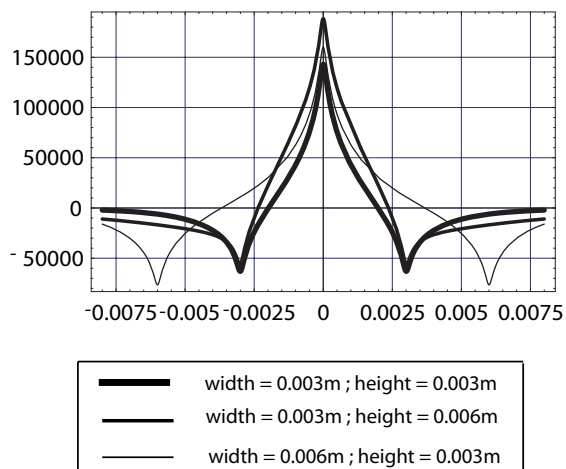

Fig. 12. Representation of the axial stiffness exerted between two ring permanent magnets versus inner ring width $r_{in} = 0.025\text{m}$, $r_{out} = 0.028\text{m}$, $r_{out2} = 0.0249\text{m}$, $J = 1\text{T}$, $h = 0.003\text{m}$, $z_b - z_a = 0.003\text{m}$.

- [7] J. P. Selvaggi, S. Salon, O. M. Kwon, and M. V. K. Chari, "Calculating the external magnetic field from permanent magnets in permanent-magnet motors - an alternative method," *IEEE Trans. Magn.*, vol. 40, no. 5, pp. 3278–3285, 2004.
- [8] J. Conway, "Inductance calculations for noncoaxial coils using bessel functions," *IEEE Trans. Magn.*, vol. 43, no. 3, pp. 1023–1034, 2007.
- [9] J. Conway, "Noncoaxial inductance calculations without the vector potential for axisymmetric coils and planar coils," *IEEE Trans. Magn.*, vol. 44, no. 10, pp. 453–462, 2008.
- [10] J. P. Selvaggi, S. Salon, O. M. Kwon, and M. V. K. Chari, "Computation of the three-dimensional magnetic field from solid permanent-magnet bipolar cylinders by employing toroidal harmonics," *IEEE Trans. Magn.*, vol. 43, no. 10, pp. 3833–3839, 2007.
- [11] K. Kim, E. Levi, Z. Zabar, and L. Birenbaum, "Restoring force between two noncoaxial circular coils," *IEEE Trans. Magn.*, vol. 32, no. 32, pp. 478–484, 1996.
- [12] S. Babic, C. Akyel, S. Salon, and S. Kincic, "New expressions for calculating the magnetic field created by radial current in massive disks," *IEEE Trans. Magn.*, vol. 38, no. 2, pp. 497–500, 2002.
- [13] S. Babic and M. M. Gavrilovic, "New expression for calculating magnetic fields due to current-carrying solid conductors," *IEEE Trans. Magn.*, vol. 33, no. 5, pp. 4134–4136, 1997.
- [14] P. Samanta and H. Hirani, "Magnetic bearing configurations: Theoretical and experimental studies," *IEEE Trans. Magn.*, vol. 44, no. 2, pp. 292–300, 2008.
- [15] B. Azzerboni and G. Saraceno, "Three-dimensional calculation of the magnetic field created by current-carrying massive disks," *IEEE Trans. Magn.*, vol. 34, no. 5, pp. 2601–2604, 1998.
- [16] B. Azzerboni and E. Cardelli, "Magnetic field evaluation for disk conductors," *IEEE Trans. Magn.*, vol. 29, no. 6, pp. 2419–2421, 1993.
- [17] B. Azzerboni, E. Cardelli, M. Raugi, A. Tellini, and G. Tina, "Analytic expressions for magnetic field from finite curved conductors," *IEEE Trans. Magn.*, vol. 27, no. 2, pp. 750–757, 1991.
- [18] C. Blache and G. Lemarquand, "New structures for linear displacement sensor with high magnetic field gradient," *IEEE Trans. Magn.*, vol. 28, no. 5, pp. 2196–2198, 1992.
- [19] G. Lemarquand and V. Lemarquand, "Annular magnet position sensor," *IEEE Trans. Magn.*, vol. 26, no. 5, pp. 2041–2043, 1990.
- [20] H. L. Rakotoarison, J. P. Yonnet, and B. Delinchant, "Using coulombian approach for modeling scalar potential and magnetic field of a permanent magnet with radial polarization," *IEEE Trans. Magn.*, vol. 43, no. 4, pp. 1261–1264, 2007.
- [21] V. Lemarquand, J. F. Charpentier, and G. Lemarquand, "Nonsinusoidal torque of permanent-magnet couplings," *IEEE Trans. Magn.*, vol. 35, no. 5, pp. 4200–4205, 1999.
- [22] J. F. Charpentier and G. Lemarquand, "Calculation of ironless permanent magnet coupling using semi-numerical magnetic pole theory method," *COMPEL*, vol. 20, no. 1, pp. 72–89, 2001.
- [23] P. Elies and G. Lemarquand, "Analytical optimization of the torque of a permanent-magnet coaxial synchronous coupling," *IEEE Trans. Magn.*, vol. 34, no. 4, pp. 2267–2273, 1998.
- [24] Z. Zhu, Z. Xia, and D. Howe, "Comparison of halbach magnetized brushless machines based on discrete magnet segments or a single ring magnet," *IEEE Trans. Magn.*, vol. 38, no. 9, pp. 2997–2999, 2002.
- [25] R. Ravaud, G. Lemarquand, V. Lemarquand, and C. Depollier, "Analytical calculation of the magnetic field created by permanent-magnet rings," *IEEE Trans. Magn.*, vol. 44, no. 8, pp. 1982–1989, 2008.
- [26] R. Ravaud, G. Lemarquand, V. Lemarquand, and C. Depollier, "The three exact components of the magnetic field created by a radially magnetized tile permanent magnet.," *Progress in Electromagnetics Research, PIER* 88, pp. 307–319, 2008.

- [27] R. Ravaud, G. Lemarquand, V. Lemarquand, and C. Depollier, "Discussion about the analytical calculation of the magnetic field created by permanent magnets.," *Progress in Electromagnetics Research B*, vol. 11, pp. 281–297, 2009.
- [28] R. Ravaud, G. Lemarquand, V. Lemarquand, and C. Depollier, "Magnetic field produced by a tile permanent magnet whose polarization is both uniform and tangential," *Progress in Electromagnetics Research B*, vol. 13, pp. 1–20, 2009.
- [29] E. Durand, *Magnetostatique*. Masson Editeur, Paris, France, 1968.
- [30] <http://www.univ-lemans.fr/~glemar>.