



HAL
open science

Application of turbulent pulsating flows to the bacterial removal during a cleaning in place procedure. Part 2 Effects on cleaning efficiency

Walid Blel, Patrick Legentilhomme, Thierry Bénézech, Jack Legrand, Caroline Le Gentil-Lelièvre

► To cite this version:

Walid Blel, Patrick Legentilhomme, Thierry Bénézech, Jack Legrand, Caroline Le Gentil-Lelièvre. Application of turbulent pulsating flows to the bacterial removal during a cleaning in place procedure. Part 2 Effects on cleaning efficiency. *Journal of Food Engineering*, 2009, 90 (4), pp.433-440. 10.1016/j.jfoodeng.2008.07.019 . hal-00400256

HAL Id: hal-00400256

<https://hal.science/hal-00400256>

Submitted on 25 Jun 2018

HAL is a multi-disciplinary open access archive for the deposit and dissemination of scientific research documents, whether they are published or not. The documents may come from teaching and research institutions in France or abroad, or from public or private research centers.

L'archive ouverte pluridisciplinaire **HAL**, est destinée au dépôt et à la diffusion de documents scientifiques de niveau recherche, publiés ou non, émanant des établissements d'enseignement et de recherche français ou étrangers, des laboratoires publics ou privés.

Application of turbulent pulsating flows to the bacterial removal during a cleaning in place procedure. Part 2: Effects on cleaning efficiency

W. Blel^a, P. Legentilhomme^a, T. Bénézech^b, J. Legrand^a, C. Le Gentil-Lelièvre^{b,*}

^a Université de Nantes, CNRS, GEPEA, UMR 6144, CRTT, 37 boulevard de l'Université, BP 406, F-44602 Saint-Nazaire Cedex, France

^b INRA, UR638, 369 rue Jules Guesde, BP 20039, F-59651 Villeneuve d'Ascq Cedex, France

Pulsating turbulent flows effects on cleaning in place procedure of straight pipes were investigated for various pulsations parameters (frequency and amplitude) and mean velocities of the flow. Pulsations generation was made with a new system which allows high amplitude of pulsations. Experiments showed the contribution of the different pulsation parameters, in the removal of adhered bacterial spores, in addition to the effect of the mean velocity of the flow. A high level of the cleaning rate is observed despite the reduction of the magnitude of the mean velocity. This result can be explained by the effect of the two pulsations parameters (amplitude and frequency) which ensure a high wall shear rate. The study of the cleaning kinetics has shown the increase of the removal constant rate of spores using pulsed flow in comparison with the use of a steady turbulent flow.

1. Introduction

To ensure food safety of products, efficient cleaning procedures are needed. However, the costs of these procedures are important (productivity losses, energy cost, cleaning chemicals and their environmental impact (Sandu and Singh, 1991)). It is therefore pertinent to optimise the cleaning cycles in order to obtain both environmental and economic improvements. On the other hand, it was shown that the key parameter in cleaning enhancement is the wall shear stress components imposed by the flow at the equipment surface (Blel et al., 2007; Grasshoff, 1992; Lelièvre et al., 2002a). The contribution of the fluctuating component of the shear rate in addition to the mean value on bacterial removal is put forward in the literature (Blel et al., 2007; Lelièvre et al., 2002a).

High values of wall shear stress can be achieved using larger flow velocities and are used in some commercial cleaning in place (CIP) systems to reduce cleaning time (Celnik et al., 2006). However, wall shear stress components can be increased using transient flow. Indeed, Pérez-Herranz et al. (1999) showed that pulsating flows allow to enhance mass transfer due to the increase of the local velocity gradient at the wall.

Different works have been carried out on the use of pulsating flow during cleaning. The term pulsating covers a wide range of applications which differ according to the pulsations frequency.

Ultrasonic cleaning, especially with high frequency and low amplitude waves, is a recent cleaning technique. It was tested by Mott et al. (1997) for biofilm removal and by Grasshoff (1997) for the cleaning of cheese moulds, but its application to dairy equipment is limited by the penetration depth of ultrasound waves, especially for heat exchangers (Grasshoff, 1997). Niemczewski (2007) showed that water cavitation phenomenon, induced by the ultrasonic cleaning, allows a high cleaning rate of organic deposition. The application of compressible waves, in cleaning process, was also studied by Brizzolara et al. (1999) using acoustic pulsating waves for controlling and preventing biological fouling at equipment surfaces. Experimental works of Hankinson and Carver (1986) on the removal of dried milk deposits using a pulsation system inducing a water hammer phenomenon showed no effect on the deposit removal. They deduced that the generated shear forces were lower than the adhesion ones of the deposit.

Dynamics and applications of pulsed flow in cylindrical pipes were studied by Edwards and Wilkinson (1971). The pulsed flow was generated by imposing a harmonic pressure gradient to a steady flow, thus increasing local shear rate and pressure at the interface deposit/liquid (Gillham et al., 2000). Ziskind et al. (2000) studied the effect of mean and fluctuating shear stress components on the particles removal from the wall. They have shown the interest of oscillating flows in particles removal when the mean shear stress is not high enough. Flow oscillations can induce the weakening and the breaking of the bonds between particles and the adhesion support. Studies of protein deposits cleanability

* Corresponding author. Tel.: +33 3 20 43 54 29; fax: +33 3 20 43 54 26.
E-mail address: Caroline.LeGentil@lille.inra.fr (C. Le Gentil-Lelièvre).

Nomenclature

D	pipe diameter (m)	X_{factor}	dimensionless form of the tested factor level
k	effective removal rate constant (min^{-1})	X_0	mean of extreme factor levels (factor unit)
k'	effective deposition rate constant (min^{-1})	X_1	factor level (factor unit)
$N(t)$	instantaneous number of adhered spores (CFU/cm^2)	X_2	half-interval of the experimental domain of the factor (factor unit)
N_R	residual number of adhered spores (CFU/cm^2)	v, v_{max}	average and maximum velocities (m/s)
N_0	initial number of adhered spores (CFU/cm^2)	v_p	amplitude of the pulsations (m/s)
Re_{max}	maximum Reynolds number: Dv_{max}/ν (dimensionless)	ν	kinematic viscosity (m^2/s)
Re	average Reynolds number: Dv/ν (dimensionless)		
Re_p	pulsating Reynolds number: Dv_p/ν (dimensionless)		

under pulsating flow were carried out by Farries and Patel (1993). These authors showed that the low frequencies (0.1–2 Hz) and the large amplitude pulsations increase the removal rate of the protein deposits. Gillham et al. (2000) works were conducted on the detachment of protein deposits by laminar pulsating flow at low frequencies (≤ 2 Hz) and high amplitude of pulsations. They showed an enhancement of cleaning rates under this flow conditions. In addition, these authors found that the cleaning rate peaks coincide with the thermal conductivity decrease of the deposited layer. This result proves that pulsations can induce the breaking of the deposition matrix.

However, pulsating flows are often difficult to use due to the complexity of the pulsation generation systems and also by the high number of variables governing this type of flow (Gillham et al., 2000). It can also be related to the drawback of possible equipment damaging that could induce some pulsation generators due to eventual water hammer. Pulsating flows can be produced by reciprocating pumps or by steady flow pumps together with pulsing generator like bellows or piston apparatus (Gillham et al., 2000). The advantage of these pulsation systems in cleaning processes, in comparison with the application of compressible waves (as acoustic pulsation or ultrasonic system), consists in the facility to fit them in a CIP system.

Given that the application of harmonic pulsations in turbulent flow plays a relevant role in mass and heat transfers enhancement (Pérez-Herranz et al., 1999), the present study investigates the effect of this flow arrangement on the detachment of adhered *Bacillus cereus* spores from a series of stainless steel pipes under pulsating flow conditions produced by the system described in

the first part of this paper (Experimental analysis of wall shear stress in a cylindrical pipe). Different pulsation conditions were compared to the steady flow at high Reynolds number and influences of both amplitude and frequency of pulsations, in addition to the mean fluid velocity, on the amount of spore removal are discussed. Finally, removal kinetics of spores are carried out, under steady and pulsating flow conditions, in order to determine the influence of pulsations in the control of cleaning duration.

2. Materials and methods

2.1. Pulsations generator system

The generation of pulsations was carried out with a new system which allows producing high amplitudes of pulsations for a turbulent flow rate at high Reynolds numbers and ensuring a perfect stability of the whole installation. Details on the pulsations generator system are given in the first part of this paper (Blel et al., submitted for publication).

The pulsations generator consists of two-way flow (Fig. 1). The first way, containing a solenoid valve (ASCO/JOUOMATIC authorized for food applications) allows the generation of a jet fluid flow at high velocity. The second way induces a steady flow component which allows a net flow different from zero at the exit of the pulsation unit when the solenoid valve is closed. In comparison with the interrupter flow method described in the literature (Lemlich, 1961) which can induce water hammer phenomenon, the second way, used in this system, allows the attenuation of the interruption flow effects generated by the solenoid valve on the equipment. A

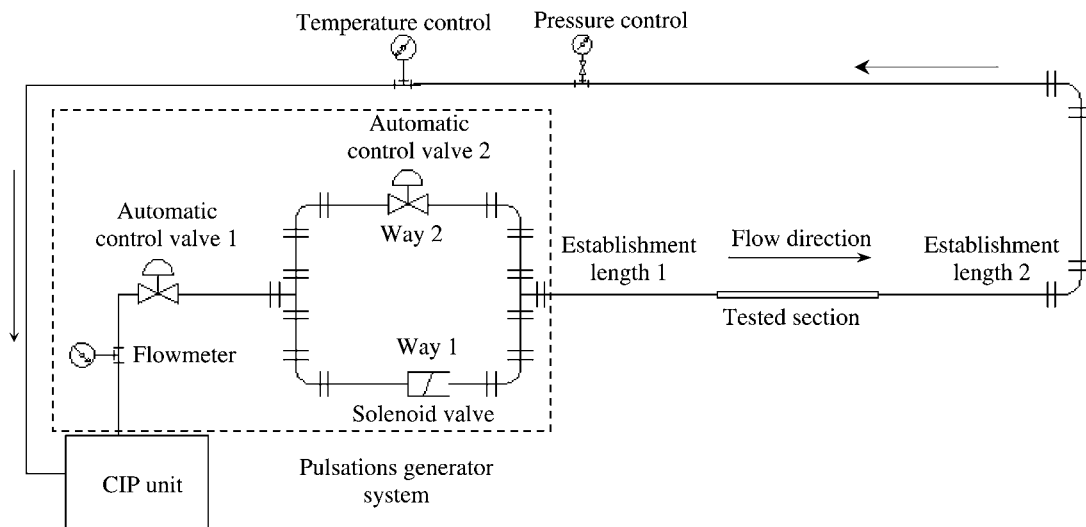

Fig. 1. Schematic diagram of the pulsation generation system and the tested section.

Table 1

Pulsations parameters determined for each condition at 20 °C

No.	Pulsation condition	Mean velocity (m/s)	Amplitude of the pulsations (m/s)	Frequency of the pulsations (Hz)	Re_{max}	Re_p	Re
(a)	500–500 ms (1600–2600 L/h) ^a	1.54	0.48	1	48210	11525	36690
(b)	100–300 ms (1600–2600 L/h)	1.47	0.40	2.5	44430	9530	35000
(c)	100–500 ms (1600–2600 L/h)	1.27	0.61	1.66	44790	14540	30250
(d)	50–300 ms (1600–2600 L/h)	1.27	0.40	2.86	39730	9500	30250
(e)	100–300 (1200–2600 L/h)	1.21	0.73	2.5	46170	17390	28770
(f)	50–300 ms (1200–2600 L/h)	1.03	0.60	2.86	38970	14450	24520
(g)	100–500 ms (1200–2600 L/h)	1.02	0.81	1.66	43550	19270	24280
(h)	100–300 ms (600–2200 L/h)	0.78	0.73	2.5	35850	17320	18530
(i)	100–300 ms (300–1500 L/h)	0.59	0.69	2.5	30510	16500	14020
(j)	Steady (2200 L/h)	1.47	0	0	0	0	35000

^a Opening time – closing time (minimum flow rate – maximum flow rate)

detailed study of the hydrodynamics of the flow induced by this pulsation generator in a straight pipe is given in the first part of this paper (Blel et al., submitted for publication).

Table 1 gathers pulsations parameters corresponding to each condition, with Reynolds numbers Re_{max} , Re_p and Re , respectively, calculated for the maximum velocity, the amplitude pulsation and the average velocity. Each pulsating condition is defined by: opening time – closing time (minimum flow rate – maximum flow rate).

2.2. Set-up

A schematic drawing of the installation is shown in Fig. 1. Measurements of the amount of residual contamination after CIP procedures under the different flow conditions were carried out in four straight pipes (2.30×10^{-2} m in inner diameter and 25×10^{-2} m in length) made of stainless steel (316 Bright Annealed Finish; average absolute roughness $0.3 \pm 0.05 \mu\text{m}$).

The tested pipes were placed downstream the pulsations generator (tested section in Fig. 1) after a flow establishment length of 70×10^{-2} m (30 times the inner diameter of the pipe). Before each experiment, pipes were cleaned by sodium hydroxide (2% w/w) at 80 °C during 30 min and under a flow rate of 4500 L/h.

2.3. Determination of the residual contamination after a CIP

2.3.1. Soiling procedure

The tested pipes were soiled by spores of *B. cereus* CUETM 98/4 (Collection Unité Ecotoxicologie, Villeneuve d'Ascq, France). This strain was isolated from a dairy production line. *B. cereus* spores are a public health hazard widespread in nature and frequently isolated from dairy products and from surfaces of equipment. Pipes soiling were done under static flow conditions, by a suspension of spores in water at 10^5 CFU/mL during 1 h at room temperature. Static conditions were chosen in order to obtain homogeneous level of contamination on the pipes surface in order to focus on the effects of hydrodynamics during bacterial removal. Pipes were vertically filled with the soiling suspension and turned upside down every 15 min.

2.3.2. CIP procedure

After the soiling step, pipes were drained and placed downstream of the pulsations generator which is connected to a CIP pilot plant. Pipes were then rinsed, with softened water at room temperature using steady flow condition, for 3 min at 300 L/h ($Re = 5000$ for 2.30×10^{-2} m inner pipe diameter). Cleaning under pulsating or steady conditions was then performed with sodium hydroxide (0.5% w/w) at 60 °C for 10 min under flow characteristics presented in Table 1. The density of the detergent solution was 985 kg/m^3 and its dynamic viscosity was $0.583 \times 10^{-3} \text{ Pa s}$ at 60 °C. Pipes were finally rinsed for 5 min with softened water at steady flow

rate equal to 600 L/h ($Re = 10000$ for 2.30×10^{-2} m inner pipe diameter). For each flow condition, trial was performed in triplicate.

2.3.3. Kinetics study procedure

The soiling step was the same as described above for five series of four pipes. They were then rinsed with softened water at room temperature and under steady flow condition, for 3 min at 300 L/h ($Re = 5000$ for 2.30×10^{-2} m inner pipe diameter). Each series of pipes was cleaned during a limited time (0, 5, 10, 15 and 30 min) (Lelièvre et al., 2002b). These times correspond to the period during which the contaminated pipes are exposed to the action of sodium hydroxide (0.5% w/w) at 60 °C. At 0 min, four soiled control pipes were removed from the installation (initial point of the kinetics) to be replaced by four unsoiled pipes. Flow pulsations are applied during sodium hydroxide circulation. At each time range (5, 10, 15 and 30 min), four pipes were removed from the installation and replaced by an equivalent length of pipe. The removed pipes were soaked in softened water in order to eliminate sodium hydroxide. This procedure allows the determination of the residual contamination after 0, 5, 10, 15 and 30 min of cleaning. The obtained results are used to determine the cleaning kinetics. Experiments were carried out with two flow conditions: a steady flow at 2200 L/h and the pulsating condition (h) (Table 1). Each trial was performed in triplicate.

2.3.4. Spore detection

The adhering bacteria remaining after the CIP procedure were counted using the tetrazolium chloride (TTC) agar overly technique (Hüsmark et al., 1999). After the cleaning step, pipes were dissociated and half-filled vertically with TTC agar and incubated horizontally for 4 h at room temperature. Then, the moulded agar was gently detached from the steel surfaces, extracted from the pipes and further incubated for 20 h at 30 °C. *Bacillus* colonies, appearing in red, were distinguishable at the mould surface and distributed according to the position of the adhered spores at the inner wall of pipes. Thus, for each series of pipes, the number of colonies forming units per square centimeter (CFU/cm^2) was determined. In order to limit experimental variability between the compared conditions (steady and pulsating flows), the presented results correspond to experiments made the same day in the same experimental conditions and using the same soiling solution.

2.3.5. Statistical analysis

Comparisons between the tested conditions were performed using statistical analysis with S-plus software (Seattle, USA). The Friedman multiple comparisons test (Bénézech et al., 2002) was then used to confirm the difference between the condition flow effects on the spores removal. Flow conditions are considered significantly different for *P*-value lower than 5%.

In order to determine the most effective parameter between amplitude and frequency of pulsations on *B. cereus* removal, design of experiments (DOE) method, with factorial experiment at two factors was carried out. The interaction between the two pulsations parameters (see Part 1) justifies the use of this experimental methodology. In this approach, analysis is purely experimental and the studied system is considered as a black box. If experimental design is carried out properly, a mathematical model can be defined which describes the behaviour of the investigated parameter. Prediction equations of this model can be used for plotting response surfaces. These response surfaces can then be used in the process of optimisation (Goupy, 1999). The system responses are evaluated according to the setting of the input parameters (factors). Four pulsating flow conditions were analysed (conditions (b), (d), (e) and (f)) and three repetitions were done for each condition. The first factor corresponds to the frequency of pulsations; two levels were used (2.5 Hz and 2.86 Hz). Levels codification allows to affect “-1” for the low value and “1” for the high one. The second factor corresponds to the amplitude of pulsations. The low and high levels of amplitude correspond, respectively, to 0.40 m/s (codified by “-1”) and 0.73 m/s (codified by “1”).

As explained in the first part of this paper (Blel et al., submitted for publication), the amplitude of pulsations depends on both the difference between the flow rates of automatic valves 1 and 2, and the opening time of the solenoid valve. Consequently, it is difficult to obtain the same amplitude for two different pulsating conditions. Condition (f), which describes the analysed factors at high levels, presents amplitude of pulsations different from 0.73 m/s (the highest level of amplitude in these experiments). The passage to central reduced coordinates according to Eq. (1) (Goupy, 1999) allows to obtain the level codification of the amplitude of pulsations to be “0.21” for this condition

$$X_{\text{factor}} = (X_1 - X_0)/X_2, \quad (1)$$

where X_{factor} is the dimensionless form of the tested factor level, X_0 is the mean of extreme factor levels, X_1 is the factor level and X_2 is the half-interval of the experimental domain of the factor.

3. Experimental results and analysis

3.1. Pulsating flows effects on the removal of *B. cereus*: comparison with the steady flow condition

3.1.1. Pulsating conditions at high mean velocity and low pulsations parameters

Pulsating conditions (a) and (c) are compared to the steady flow (j) in order to explain the effect of the harmonic velocity variation on the spores removal, given that the mean velocity for these conditions is close to that corresponding to the steady flow (≈ 1.47 m/s). However, they present a low frequency and amplitude of pulsations in comparison with the whole range analysed in this study (Table 1).

Fig. 2 illustrates the residual contamination (CFU/cm²) after the CIP procedure for the steady flow and the pulsating conditions (a) and (c). Three repetitions are carried out for each flow condition. Analysis of variance between flow conditions was carried out in order to observe the residual contamination differences. The Friedman multiple comparison test *P*-value was found to be of 0.0186. This emphasized a significant difference between the steady flow and the two pulsating conditions. The residual soiling level is less important in pulsed flow and the improvement of the cleaning efficiency of the tested tubes, in comparison with the steady flow, was found to be 47% and 76.5%, respectively, for conditions (a) and (c). This result can be explained by the effect of flow pulsations on the mean and the fluctuating components of the wall shear stress, con-

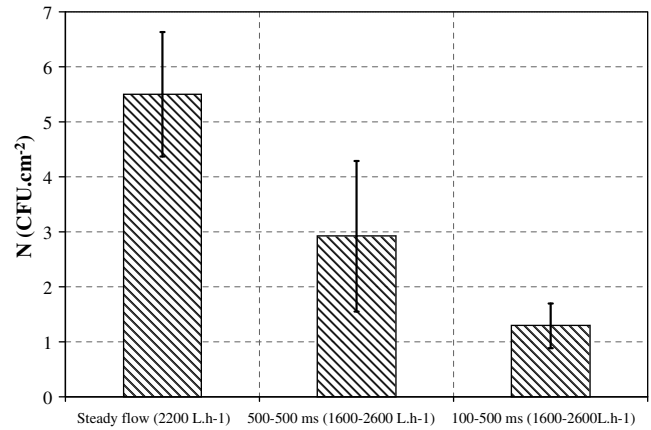

Fig. 2. Residual contamination after the CIP procedure for the steady flow (2200 L/h) (condition (j)) and pulsating conditions (a) (500–500 ms (1600–2600 L/h)) and (c) (100–500 ms (1600–2600 L/h)).

sidered in many studies as the major parameters which affect cleaning rate and microbial removal from the wall equipment (Blel et al., 2007; Grasshoff, 1992; Lelièvre et al., 2002a). Hydrodynamic analysis made in the first part of this paper (Blel et al., submitted for publication) emphasized the increase of the two wall shear stress components under pulsating condition (a) in comparison with the steady flow and support the observed cleaning results.

The reduction of the opening time of the solenoid valve induces the increase of the amplitude and the frequency of the pulsations for condition (c) in comparison with condition (a). In addition, for a fixed time of cleaning under pulsating flow, condition (c) presents more pulsating cycles than condition (a). In this context, experimental measurements of Ziskind et al. (1995) showed that particle removal from a surface exposed to turbulent flow is not instantaneous and takes place over a period of mechanical forces application which corresponds to the turbulent energy transfer from the flow to the particle. Thus, detachment from the surface occurs when the particle accumulates enough energy, considered to be more important than the adhesion forces (Ziskind et al., 1995). This effect can explain the increase of the removal level of spores with condition (c) which corresponds to 56% in the improvement of the cleaning rate compared to condition (a). The enhancement of the cleaning rate with the increase of the amplitude and the frequency of pulsations allows to confirm the obtained results of Gillham et al. (2000) on the cleaning of whey protein soils, despite the difference in the Reynolds number and the range of pulsation parameters. The contribution of both parameters on the enhancement of other industrial applications is also proven by Finnigan and Howell (1989) on the ultrafiltration in a tubular membrane.

3.1.2. Pulsating conditions at moderate mean velocity and high pulsations parameters

In order to reduce the cleaning cost by the decrease of the pumping energy and the consumption of cleaning solution, pulsating conditions with high pulsations parameters and less important mean velocity than that of the standard procedure are analysed together and compared to the steady flow. Fig. 3 showed the residual contamination after the CIP procedure using the pulsating conditions (e, g and h) and the steady flow. Statistical analysis showed a significant reduction in the residual level of adhering spores after cleaning with pulsating flow compared to the steady flow condition (*P*-value = 0.0263).

Comparison between condition (g) and the two conditions (e) and (h) showed that, despite the reduction of the amplitude of pul-

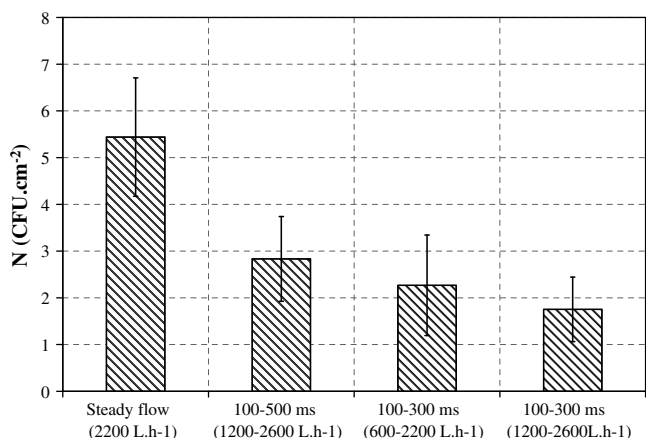

Fig. 3. Residual contamination after the CIP procedure for the steady flow (2200 L/h) and, respectively, the pulsating conditions (g) (100–500 ms (1200–2600 L/h)), (h) (100–300 ms (600–2200 L/h)) and (e) (100–300 ms (1200–2600 L/h)).

sation (from 0.81 m/s to 0.73 m/s, respectively, for conditions (g) and both (e) and (h)), an increase of the frequency (from 1.66 Hz to 2.5 Hz) induces an increase of the spore removal (38% and 20%, respectively, for pulsating conditions (e) and (h)).

The cleaning enhancement observed for condition (e) can be explained by the effect of the mean wall shear stress, which is higher than for condition (g). This observation is confirmed by the mean wall shear stress measured in the first part of this paper, which presents high values for the three analysed positions with condition (e) for a room temperature equal to 20 °C (Blel et al., submitted for publication). The increase of the mean wall shear stress together with the frequency parameter is also observed by Pérez-Herranz et al. (1999) in an annular pulsating electro dialysis cell due to the pulsations effect on the near-wall region.

However, the cleaning improvement observed for the condition (h) cannot only be explained by the effect of the mean wall shear stress, because lower values are obtained with condition (h) than (e) (Blel et al., submitted for publication). Nevertheless, the pulsations amplitude of this condition (0.73 m/s) is very close to the mean velocity (0.78 m/s). Thus, the flow can be considered more disturbed due to the nearer phenomenon of recirculation at the center core. This result induces fluctuating wall shear stress increase, which contributes significantly to spores removal. Indeed, spectral analyses made in the first part (Blel et al., submitted for publication) have shown that the fluctuating energy of the shear rate is more important with the condition (h). This observation allows to explain the difference in the cleaning level emphasized with the condition (g).

On the other hand, conditions (e) and (h) are characterized by the same pulsation amplitude and frequency and a significant difference in the mean velocity value (1.21 m/s against 0.78 m/s, respectively, for the conditions (e) and (h)). Thus, the increase of the cleaning level of condition (e) (23% in comparison with condition (h)) confirms the role of the flow rate on the spores removal despite the imposed pressure variation. This result is also proven by electrochemical measurements (Blel et al., submitted for publication) which showed more important wall shear stress at the three circumferential positions with condition (e) than condition (h) and corresponds to the theoretical principle of the increase of the shear stress value with the flow rate.

3.1.3. Pulsating condition with recirculation

Pulsating flow with recirculation at the center core of the pipe is considered as a good mean to enhance heat and mass transfer (Paek et al., 1999; Pérez-Herranz et al., 1999). This flow regime, ob-

tained when the amplitude of the pulsations is higher than the average velocity, corresponds to condition (i) (see Table 1). Residual contamination after the CIP procedure under this pulsating condition was compared to that obtained for the steady flow (Fig. 4). Statistical analysis applied for the two conditions and for different trials repetitions showed a significant reduction of the residual contamination under this pulsating condition (P -value = 0.0047). The improvement rate of the cleanability level in comparison to the steady flow was found to be 32%, and showed the effect of this particular flow on the spores removal from the wall equipment despite the low average velocity (0.59 m/s) compared with the steady condition (1.47 m/s). Indeed, hydrodynamic analysis showed that the obtained low mean wall shear stresses in this flow regime in comparison with the steady flow (Blel et al., submitted for publication) cannot explain the observed cleanability level. However, the recirculation occurring at the center core of the pipe induces high fluctuating shear rate at the wall for the three circumferential positions and power spectral density (PSD) of the shear rate fluctuations is more energetic at low frequencies than for the steady flow condition (Blel et al., submitted for publication). In this context, the theoretical work of Ziskind et al. (2000) has shown the effect of the fluctuation shear rate on the wall-particles links weaken, which allows to render them easier to remove and can explain the observed cleaning result with the flow condition (i).

Thus, the obtained results showed the beneficial effects of this pulsating condition, which presents an economic interest by the reduction of the pumping energy and the quantity of cleaning solution, and allow to obtain a good hygienic state of the equipment.

3.1.4. Experimental correlation of the two pulsations parameters

The determination of the most important parameter between amplitude and frequency of pulsations was made using design of experiment method. Table 2 describes trials repartitions and the obtained response for each condition, presented as the residual contamination after the CIP procedure (CFU/cm²). The obtained results showed that the studied response varied between 0.86 and 3.19 CFU/cm², which emphasizes the influence of at least one factor on the residual contamination.

Statistical analyses were made by multiple linear regression, which allows to determine explanatory variable coefficients (amplitude and frequency of pulsations) and their interaction. Variance analysis showed that the linear predictive model is a good description of the residual amount of adhering spores as a function of explanatory variables (P -value = 0.004).

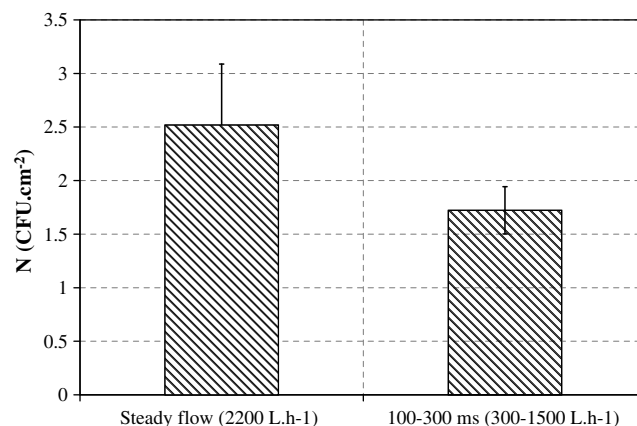

Fig. 4. Residual contamination after the CIP procedure for the steady flow (2200 L/h) and the pulsating condition (i) (100–300 ms (300–1500 L/h)).

Table 2
Presentation of the different trials analysed by the experimental design

Experiment number	Run order	Amplitude level	Frequency level	Residual contamination (CFU/cm ²)
N1	1	-1	-1	2.87
N2	9	1	-1	1.38
N3	3	-1	1	1.40
N4	2	0.21	1	1.46
N5	6	-1	-1	3.19
N6	4	1	-1	1.39
N7	12	-1	1	2.09
N8	8	0.21	1	2.39
N9	11	-1	-1	2.59
N10	5	1	-1	0.86
N11	10	-1	1	1.19
N12	7	0.21	1	1.90

Results are presented in Table 3. Coefficients variables allow discerning the effect of each factor on the removal of adhered spores, thus allowing the calculation of the residual contamination (RC) according to the following equation:

$$RC = \text{constant} + \sum_{\text{variables}} \text{coefficient} \times X_{\text{factor}} \quad (2)$$

With $X_{\text{factor}} \in [-1, 1]$.

For the amplitude and the frequency ranges fixed in this part, the single effect of the tested factors present no influence on the residual contamination response (P -values $> 5\%$). However, interaction between the two factors was found to be the significant variable (P -value = 0.0066). Fig. 5, which shows the combined influence of the two factors, is deduced from the statistical model obtained after experimental design analysis. The mean of the experimental results for each tested condition is plotted in this fig-

Table 3
Model coefficients and statistical parameters of the linear model

Residual contamination	Coefficient	Standard deviation	P -value	Confidence interval
Constant	1.949	0.125	2.92E-07	0.29
AMP	-0.271	0.155	0.1192	0.36
Fr	-0.097	0.125	0.4607	0.29
AMP \times Fr	0.565	0.155	0.0066	0.36
Confidence level			0.95	

AMP: amplitude and Fr: frequency.

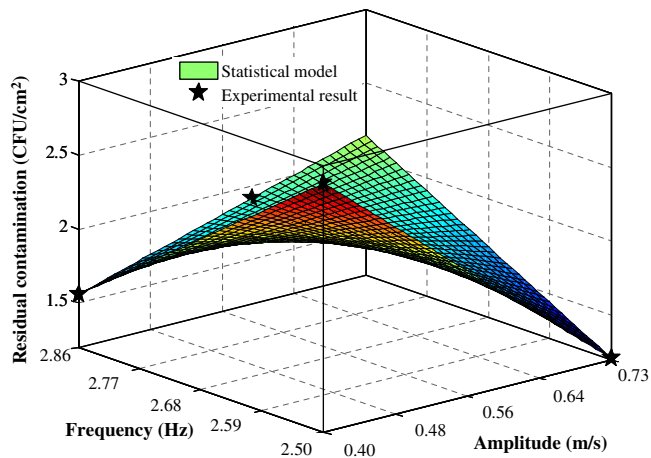

Fig. 5. Predictive residual contamination (CFU/cm²) and experimental results obtained as a function of the two explanatory variables.

ure and showed the accuracy of the predictive model. This figure puts forward an optimal of the cleaning level obtained by the combination of the high amplitude (1) and the low frequency (-1) of pulsations. For this configuration, the model predicts the lowest residual contamination (≈ 1.21 CFU/cm²). This result supports conclusions made in Section 3.1.2 on the high cleanability level with conditions (e) and (h) which present the amplitude and the frequency of pulsations equal to, respectively, 0.73 m/s and 2.5 Hz. Indeed, as explained in Part 1 (Blel et al., submitted for publication), for pulsation frequency higher than 2.5 Hz under turbulent flow, the fluid inertia dominates over most part of the flow-field and the harmonic variations are excluded. Thus, for flow conditions used in this study, the frequency of 2.5 Hz can be considered as optimal in the bacterial removal. On the other hand, the beneficial effect of large amplitude of pulsations is already demonstrated in many transfer processes (Keil and Baird, 1971; Paek et al., 1999; Wang and Zhang, 2005). However, it seems difficult, with this pulsations generator system, to go beyond the maximum value of amplitude fixed in this part (0.73 m/s), due to the stability problems of the installation.

3.1.5. Summary

This section deals with the flow effect on the residual contamination after CIP procedure on stainless steel surfaces. Pulsating flows for various pulsations parameters and mean velocities are compared to the steady flow. Analysis is also made using wall shear stress characterization investigated in the first part of this paper (Blel et al., submitted for publication). Fig. 6a and b summarize all these parameters. Mean wall shear stresses and fluctuating energies of the velocity gradient given in Fig. 6a correspond, for each condition, to the integration of the three circumferential data analysed in Part 1.

As explained in experimental procedure of cleaning analysis, pulsating conditions are divided in many series given that the

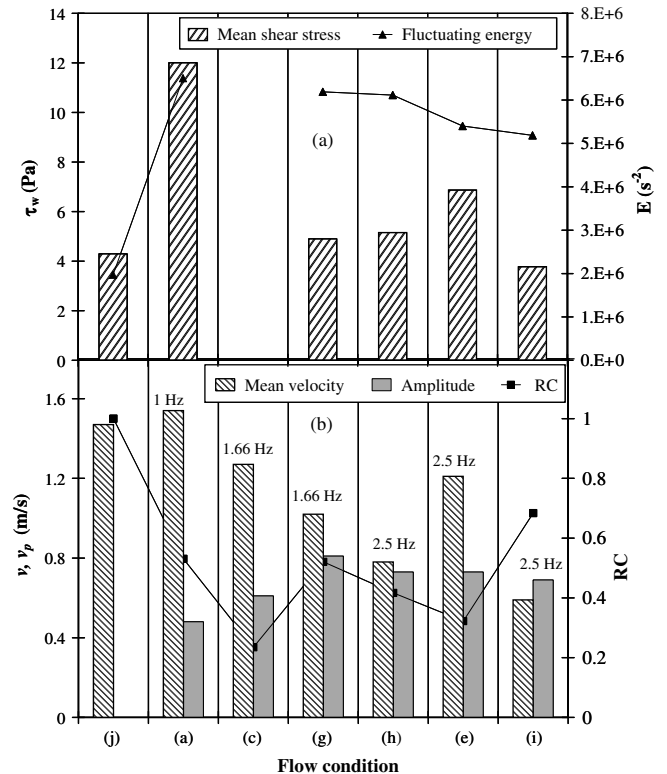

Fig. 6. Summary diagram of the pulsations effect on wall shear stress components (a) and residual contamination (RC) (b) after the CIP procedure.

impossibility to compare the different conditions at the same day. Each series of experiments, containing the steady flow, was made the same day in the same experimental condition and using the same soiling solution. Thus, comparison between the residual contamination of the all pulsating conditions is not possible due to the variability of experimental conditions from one day to another. However, given that the steady flow is analysed at each series, it is possible to report the residual contamination of pulsating conditions to that of the steady flow. Thus, the variability of the experimental condition can be excluded by the use of the dimensionless residual contamination (RC). Fig. 6b showed that, excepted for condition (a) which presents low pulsation parameters, the increase of the mean velocity under pulsating flow induces residual contamination reduction. This result emphasizes the necessity of the turbulent flow implementation together with pulsations in CIP procedure, especially when the contamination is induced by micro-organisms like *B. cereus* spores characterized by their ability to adhere firmly to stainless steel and its high resistance to cleaning procedures. This result is also verified by mean wall shear stresses more important with high mean velocity of the flow (Fig. 6a). Pulsation parameters analysis showed that for a moderate mean flow velocity, the low residual contamination is obtained with conditions (h) and (e), which combine both amplitude and frequency of pulsation of 0.73 m/s and 2.5 Hz. However, the reduction of one of these two pulsation parameters induces the increase of the residual contamination. Indeed, condition (g) is characterized by the most important amplitude of pulsation (0.81 m/s) and low frequency than condition (h) (respectively, 1.66 Hz and 2.5 Hz). These facts induce more important residual contamination despite the slight difference in the mean velocity (respectively, 1.02 m/s and 0.78 m/s). The combined effect of these two values of pulsation parameters confirms the obtained result using design of experiment method. On the other hand, it was showed that despite the high value of mean shear stress and fluctuating energy with the pulsating condition (a), the dimensionless residual contamination (RC) is more important than for the other conditions (g, h and e). This result put forward the role of the high number of pulsation cycles with sufficient amplitude value during a fixed cleaning period in the removal of adhered spores and confirms the observation of Ziskind et al. (2000) on the role of successive excitation at high frequency in the weakening and the breaking of the bonds between particles and the adhesion support. In addition, the mean velocity reduction with condition (i) slightly affects the amount of residual contamination compared with condition (a) (0.59 m/s against 1.54 m/s and 0.86 against 0.53, respectively, for the mean velocity and the RC of conditions (i) and (a)). This result emphasizes the beneficial role of pulsating flow with recirculation in the cleaning procedure. Thus, a compromise between cleaning duration and mean velocity of the flow should be found in order to ensure at once good hygienic state of equipment with minimum energetic cost.

3.1.6. Comparative study of the spores removal kinetic under pulsating and steady flows

Lelièvre et al. (2002b) have proposed a model for the removal kinetics of *B. cereus* spores under steady flow conditions in stainless steel pipes during a CIP procedure. In the present study, experimental conditions studied by Lelièvre et al. (2002b) were chosen to compare the effect of pulsating flow on the removal kinetics of *B. cereus* spores. The process of cleaning with sodium hydroxide can be described as follows:

- sodium hydroxide transport to the spore-surface interface,
- reaction of the sodium hydroxide with the binding material at the interface spore-surface,
- spores removal due to the action of wall shear forces.

Lelièvre et al. (2002b) have proposed a simple mathematical model describing the kinetic removal of bacterial spores. The model is based on the combination between the detachment and the deposition of spores suspended in the cleaning solution, on the pipe wall (Eq. (3)).

$$\frac{dN(t)}{dt} = k'[N_0 - N(t)] - k[N(t) - N_R] \quad (3)$$

Where k and k' are, respectively, the effective removal and deposition rate constants, $N(t)$ is the instantaneous number of spores remaining adhered at the surface after a CIP procedure, N_R is the number of residual adhering spores after an infinite time of cleaning and N_0 is the initial number of adhered spores. According to Lelièvre et al. (2002b), N_R is considered equal to zero.

The experimental analysis showed that the amount of deposited spores during the cleaning process is negligible (<1 CFU for 50 cm²). Thus, the deposition phenomenon can be ignored and k' is considered equal to zero. The kinetic model of cleanability can thus be written as follow:

$$N(t) = N_0 \exp(-kt) \quad (4)$$

The aim of this part is to compare kinetics between a steady condition (2200 L/h) and a periodically varying flow for which the peak values correspond to a flow rate of 2200 L/h. In addition, pulsation parameters correspond to the optimal obtained in the experimental design of the previous section (low frequency (2.5 Hz) and high amplitude of pulsations (0.73 m/s)). Three repetitions were carried out for each configuration of flow and comparisons were made for results obtained in the same experimental conditions.

The model parameters were identified and non-linear regression was performed using S-plus software in order to verify the validity of the experimental procedures. Statistical analysis showed that the first-order model gives acceptable agreement with the experimental data. Fig. 7 gives an example of the experimental and the theoretical evolution of the residual adhering spores after the CIP procedure, obtained from the first trial of the two flow conditions. Thus, the removal efficiency of bacterial spores as a function of flow conditions is characterised by the effective removal rate constant. Table 4 summarizes the effective removal rate constants (k) obtained for three trials and under the two tested flow conditions. For the same steady flow rate (2200 L/h), a close mean effective removal rate constant to that of Lelièvre et al. (2002b) was observed (respectively, 0.075 min⁻¹ and 0.073 min⁻¹ for the literature and the present work).

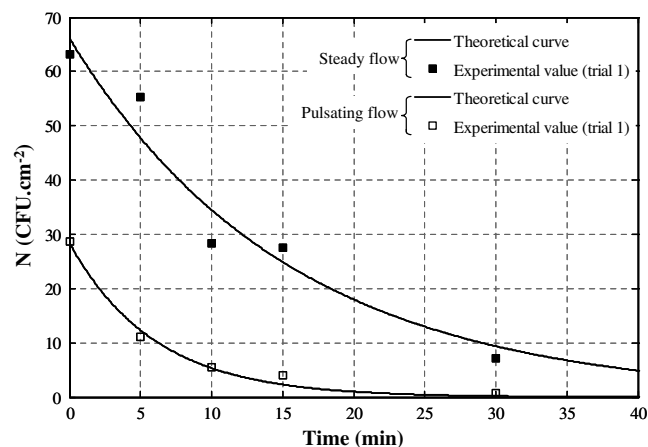

Fig. 7. Experimental and theoretical evolution of the residual adhering spores after the CIP procedure under the steady flow and the pulsating condition (h).

Table 4

Effective removal rate constants obtained for three trials with the steady flow and the pulsating condition (h)

	k (min^{-1})		
	Trial 1	Trial 2	Trial 3
Steady flow (2200 L/h)	0.065	0.082	0.071
Pulsating flow (condition (h))	0.125	0.131	0.167

Variance analysis applied on the effective removal rate constants emphasizes a significant difference between the two conditions (P -value = 0.007). The pulsating condition (h) showed a more important spores removal kinetic, illustrated by a high mean effective removal rate constant which corresponds to twice that obtained for the steady condition (respectively, 0.143 min^{-1} against 0.073 min^{-1}). Thus, in addition to the beneficial effect of the pulsating flow, demonstrated above, on the amount of removal spores adhering a stainless steel wall, this flow condition allows an important spores removal kinetic, which can induce the reduction of the cleaning duration.

4. Conclusion

Pulsating turbulent flow effects on the removal of *B. cereus* spores during a CIP procedure were analysed using a new pulsations generation system at high amplitude of pulsations. Experiments carried out for various amplitudes and frequencies showed a net improvement in the removal rate of bacterial spores from stainless steel surface, in comparison with the steady turbulent flow at high Reynolds number. Comparison with a steady flow also emphasized the contribution of each pulsation parameter in the removal of adhered *B. cereus* spores. The obtained results reveal that cleanability enhancements are obtained with low mean velocity of the flow, in comparison with the steady condition, which put forward the economical interest of this flow. Statistical analysis exhibits the significant effects of the interaction between the two pulsations parameters (0.73 m/s and 2.5 Hz, respectively, for the amplitude and the frequency of pulsation) in the cleaning rate and thus on the increase of the mean and the fluctuating shear stress components. In addition, the high amplitude of pulsations is considered as an important factor on spores removal and confirms the previous published results on the beneficial incidence of this parameter on wall transfer phenomena. The study of the cleaning kinetics has shown the increase of the effective removal rate constant of spores using pulsed flow, which allows controlling the cleaning duration and also the amount of cleaning solution.

In future works, the cleanability study, under pulsating flows, will be carried out with loops containing pieces of equipment used in food processing lines, like valves and diametrical changes, in order to investigate the effect of this flow on cleaning in place of real industrial equipment.

Acknowledgements

This work was supported by the French Ministry of Agriculture in the frame of a program involving different partners (CETIM, Laval Mayenne Technopole, LACTALIS R&D, BOCCARD – Division Alimentaire, GOAVEC INGENIERIE, PIERRE GUERIN and SERVICE INDUSTRIEL TUYAUTERIE). Authors are very grateful to Laurent

Bouvier, Pascal Debreyne, Jean Jacquemont, Jean-François Migdal, Jacky Six and Guillaume Roelens for their technical supports.

References

- Bénézech, T., Lelièvre, C., Membré, J.M., Viet, A.F., Faille, C., 2002. A new method for in-place cleanability of food processing equipment. *Journal of Food Engineering* 54, 7–15.
- Blel, W., Bénézech, T., Legentilhomme, P., Legrand, J., Le Gentil-Lelièvre, C., 2007. Effect of flow arrangement on the removal of *Bacillus* spores from stainless steel equipment surfaces during a cleaning in place procedure. *Chemical Engineering Science* 62, 3798–3808.
- Blel, W., Le Gentil-Lelièvre, C., Bénézech, T., Legrand, J., Legentilhomme, P., submitted for publication. Application of turbulent pulsating flows to the bacterial removal during a cleaning in place procedure. Part 1: Experimental analysis of wall shear stress in a cylindrical pipe. *Journal of Food Engineering*.
- Brizzolara, R.A., Walch, W., Nordham, D.J., Hoover, S.M., Mazzola, M.S., Burnett, M.S., 1999. Pulsed acoustics for biofouling control in heat exchangers and piping systems. In: *Proceedings of the Engineering Foundation Conference on Mitigation of Heat Exchanger Fouling and its Economic and Environmental Implications*. Banff, Canada.
- Celnik, M.S., Patel, M.J., Pore, M., Scott, D.M., Wilson, D.I., 2006. Modelling laminar pulsed flow for the enhancement of cleaning. *Chemical Engineering Science* 61, 2079–2084.
- Edwards, M.F., Wilkinson, M.A., 1971. Review of potential applications of pulsating flow in pipes. *Transactions of the Institution of Chemical Engineers* 49, 85–94.
- Farries, R., Patel, H., 1993. The effect of flow reversal and pulsing on surface cleaning. Part II. Project Report. University of Cambridge.
- Finnigan, S.M., Howell, J.A., 1989. The effect of pulsatile flow on ultrafiltration flux in a baffled tubular membrane systems. *Chemical Engineering Research and Design* 67, 278–282.
- Gillham, C.R., Fryer, P.J., Hasting, A.P.M., Wilson, D.I., 2000. Enhanced cleaning of whey protein soils using pulsed flows. *Journal of Food Engineering* 46, 199–209.
- Goupy, J., 1999. *Plans d'expériences pour surfaces de réponse*. Ed. Dunod, Paris, France.
- Grasshoff, A., 1992. Hygienic design: the basis for computer controlled automation. *Transaction of the Institute of Chemical Engineers, Part C. Food and Bioproducts Processing* 70, 69–77.
- Grasshoff, A., 1997. Cleaning of heat treatment equipment. In: Visser, H. (Ed.), *Fouling and cleaning of heat treatment equipment*. IDF Monograph #328, IDF, Brussels, pp. 32–44.
- Hankinson, D.J., Carver, S.E., 1986. Fluid dynamic relationships involved in circulation cleaning. *Journal of Dairy Science* 51, 1761–1767.
- Hüsmark, U., Bénézech, T., Faille, C., Rönner, U., 1999. *Bacillus* spores and moulding with TTC AGAR: a useful method for the assessment of food processing equipment cleanability. *Biofouling* 14, 15–24.
- Keil, R.H., Baird, M.H.I., 1971. Enhancement of heat transfer by flow pulsation. *Industrial and Engineering Chemistry Process Design and Development* 10, 473–478.
- Lelièvre, C., Legentilhomme, P., Gaucher, C., Legrand, J., Faille, C., Bénézech, T., 2002a. Cleaning in place: effect of local wall shear stress variation on bacterial removal from stainless steel equipment. *Chemical Engineering Science* 57, 1287–1297.
- Lelièvre, C., Antonini, G., Faille, C., Bénézech, T., 2002b. Cleaning-in-place, modelling of cleaning kinetics of pipes soiled by *Bacillus* spores assuming a process combining removal and deposition. *Transaction of the Institute of Chemical Engineers, Part C. Food and Bioproducts Processing* 80, 305–311.
- Lemlich, R., 1961. Vibration and pulsation boost heat transfer. *Chemical Engineering* 68, 171–176.
- Mott, I.E.C., Stickler, D.J., Coakley, W.T., Bott, T.R., 1997. Ultrasound in the control of biofilms in pipes. In: *Fouling mitigation of industrial heat-exchange equipment*. Begell House, NY, pp. 601–612.
- Niemczewski, B., 2007. Observations of water cavitation intensity under practical ultrasonic cleaning conditions. *Ultrasonics Sonochemistry* 14, 13–18.
- Paek, J.W., Kang, B.H., Hyun, J.M., 1999. Transient cool-down of a porous medium in pulsating flow. *International Journal of Heat and Mass Transfer* 42, 3523–3527.
- Pérez-Herranz, V., Guiñón, J.L., García-Antón, J., 1999. Analysis of mass and momentum transfer in an annular electro-dialysis cell in pulsed flow. *Chemical Engineering Science* 54, 1667–1675.
- Sandu, C., Singh, R.K., 1991. Energy increase in operation and cleaning due to heat exchanger cleaning in food pasteurisation. *Food Technology* 45, 84–91.
- Wang, X., Zhang, N., 2005. Numerical analysis of heat transfer in pulsating turbulent flow in a pipe. *International Journal of Heat and Mass Transfer* 48, 3957–3970.
- Ziskind, G., Fichman, M., Gutfinger, C., 1995. Resuspension of particulates from surfaces to turbulent flows—review and analysis. *Journal of Aerosol Science* 26, 613–644.
- Ziskind, G., Fichman, M., Gutfinger, C., 2000. Particle behavior on surfaces subjected to external excitations. *Journal of Aerosol Science* 31, 703–719.