



HAL
open science

Force control at low cost in pneumatic field

Xavier Brun, Mohamed Smaoui, Jean-Marie Rétif, Xuefang Lin-Shi, Eric Bideaux

► **To cite this version:**

Xavier Brun, Mohamed Smaoui, Jean-Marie Rétif, Xuefang Lin-Shi, Eric Bideaux. Force control at low cost in pneumatic field. Bath Workshop on Power Transmission & Motion Control, Sep 2006, Bath, United Kingdom. hal-00399330

HAL Id: hal-00399330

<https://hal.science/hal-00399330v1>

Submitted on 30 Apr 2019

HAL is a multi-disciplinary open access archive for the deposit and dissemination of scientific research documents, whether they are published or not. The documents may come from teaching and research institutions in France or abroad, or from public or private research centers.

L'archive ouverte pluridisciplinaire **HAL**, est destinée au dépôt et à la diffusion de documents scientifiques de niveau recherche, publiés ou non, émanant des établissements d'enseignement et de recherche français ou étrangers, des laboratoires publics ou privés.

Force control at low cost in pneumatic field

Xavier BRUN^{*}, Mohamed SMAOUI[†], Jean-Marie RETIF^{**}, Xue-Fang LIN SHI^{**}, Eric BIDEAUX^{*}.

^{*}Laboratoire d'Automatique Industrielle, INSA Lyon, Bâtiment Saint Exupéry, 25 Avenue Jean Capelle, 69621 Villeurbanne Cedex, France, <http://www-lai.insa-lyon.fr>

Email contact: xavier.brun@insa-lyon.fr

^{**}Centre Génie Electrique de Lyon, INSA Lyon, Bâtiment Léonard de Vinci, 21 Avenue Jean Capelle, 69621 Villeurbanne Cedex, France, <http://cegely.cnrs.fr/>

ABSTRACT

At the present time in the pneumatic field, when a system requires a wide range of force control, servodistributors are currently used. On/off distributors are used when the system is simpler and only a small range of force values are required [1]. The work presented here consists of using on/off distributors in a system which requires a wide range of force values. This has been carried out in order to reduce the cost of complex systems [2-4], because present day distributors are five to ten times cheaper than servodistributors.

This paper presents a new control method applied to the electro-pneumatic field. This strategy originates from the hybrid control theory recently developed for the control of asynchronous or synchronous electrical motors, [5, 6]. This control strategy is an improvement of the proposed one in [4].

Based on both cylinder and distributor models, the hybrid control presented here chooses the best state for each on/off distributor to reach the desired force value. Hybrid control is based on a state space model for both the energy modulator and the continuous sub-process. For this model, a control vector, depending on the number of possible configurations for the energy modulator, is defined. Two formal approaches have been developed for choosing a control vector to track the reference state of interest in the state space. Experimental results are presented and discussed.

KEYWORDS: hybrid control, on/off distributor, electro-pneumatic, experimental results, force control.

1. INTRODUCTION

At the present time in the pneumatic field, when a system requires a wide range of force control, servodistributors are currently used [7-11]. On/off distributors are used when the system is simpler and only a small range of force values are required [1]. The work presented here consists of using on/off distributors in a system that requires a wide range of force values. This has been carried out in order to reduce the cost of complex systems [2, 3], because present day distributors are five to ten times cheaper than servodistributors.

Using on/off distributors for reaching a desired force produces to a system with energy modulators (on/off distributors) and a continuous sub-process (cylinder). Such systems define a type of Hybrid Dynamic Process (HDP). Hybrid control [5,6, 12], which is an efficient approach for controlling this kind of system. It is based on a state space model for both the energy modulator and the continuous sub-process. For this model, a control vector, depending on the number of possible configurations for the energy modulator, is defined. A formal approach has been developed for choosing a control vector to track the reference state of interest in the state space. This control has been developed for the control of AC machines driven by inverters. Very good dynamic performance has been obtained (Retif 2004). In this paper, the hybrid control is applied for the force control of the pneumatic cylinder where the chosen state variables of interest are the pressure in each chamber noted p_P and p_N . In fact, the control of both pressures leads to the control of the pneumatic force. Usually in the electrical field, from where the hybrid control algorithm is issued, the time commutation of the transistors can be neglected, [5,6, 12] with regards to the sample time (respectively equal to few microseconds and few hundred microseconds). The main difficulty in our context is that the on/off distributors used are quite slow. In the electropneumatic field [13], the bandwidth of cheap on/off components is very small (between 5 and 20 Hertz) and cannot be neglected when the control frequency is of the same order. Some propositions were proposed in literature to increasing the dynamic performance of pneumatic servo-systems with digital valves. In this paper the aim is not to use PWM concept [14], for limited energy consumption, and not to increase the number of valves as in [15] for limited cost. This problem is not present when the power modulator is a servodistributor and therefore other control algorithms are used [8, 16-20], because hybrid control is not appropriate with this type of component.

The study begins with the modelling of the continuous sub-process, then of the distributors, these are divided into two parts: static and dynamic models. The hybrid control algorithm is then developed. Finally, the first experimental results are presented and discussed and perspectives are announced for improving the performance of the system.

2. ELECTRO-PNEUMATIC SYSTEM MODELLING

In order to determine the best distributor state for reaching the desired output value, the hybrid control requires both cylinder and distributor control models. This model must use physical parameters which can be given by industrial manufacturers or which can be obtained easily from simple experimental tests. In fact the following approach must be easy to generalise to any other electropneumatic on/off distributor.

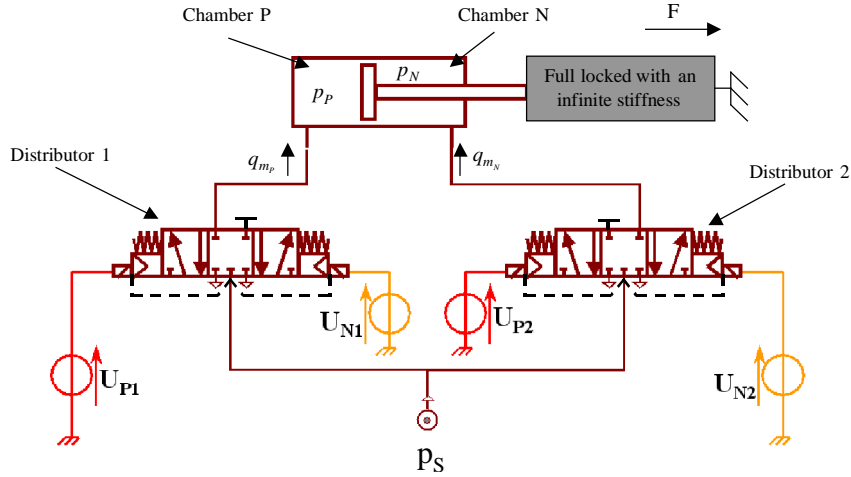

Figure.1: Schema of the electro-pneumatic system

The pneumatic system consists of a pneumatic cylinder and two electropneumatic on/off distributors. The notation 'P', respectively 'N' in Fig. 1 is attached to elements whose positive actuation induces an increase in the exerted force, or respectively, a decrease.

Table 1 shows the nine different combinations of control vectors (C1 to C9) which can be applied to the distributors. The '0' value corresponds to a null voltage and the '1' value corresponds to 5 volts. All the states where $U_{P_x} = U_{N_x} = 1$, are prohibited to avoid short-circuits in the electrical distributors. :

	C1	C2	C3	C4	C5	C6	C7	C8	C9
U_{P1}	0	1	0	0	0	1	0	0	1
U_{N1}	0	0	1	0	0	0	1	1	0
U_{P2}	0	0	0	1	0	1	0	1	0
U_{N2}	0	0	0	0	1	0	1	0	1

Table 1: Applicable controls

2.1 Actuator

The system is composed of a single rod double acting linear pneumatic cylinder (32/20). The rod of the actuator is attached to a stop end. Considering that the stiffness is infinite, there are no variations in the volume of the cylinder chambers. In our case the piston position is set to obtain the same volume in both chambers of the actuator, noted V and equal about to 0.1 litre. The aim is to control the force exerted against the stop end. Considering that the dry friction forces can be neglected, the general principal of mechanics gives the expression of the force as a function of both pressures:

$$F = S_P p_P - S_N p_N - (S_P - S_N) p_E \quad (1)$$

So the force F can be controlled due to the control of the pressure in each chamber p_P and p_N .

With the following classical assumptions [21-22], the model used for the control law synthesis can be described by the system (2).

- air is a perfect gas and its kinetic energy is negligible in the chamber,

- pressure and the temperature are homogeneous in each chamber,
- the evolution in each cylinder chamber is supposed to be polytropic of index n ,
- the temperature variation in each chamber is considered negligible with respect to the supply temperature,
- the mass flow rate leakage are neglected,
- supply and exhaust pressures are assumed to be constant.

$$\begin{cases} \frac{dp_P(t)}{dt} = \frac{nrT}{V} q_{m_P}(x_P(U_{P1}, U_{N1}, t), p_P(t)) \\ \frac{dp_N(t)}{dt} = \frac{nrT}{V} q_{m_N}(x_N(U_{P2}, U_{N2}, t), p_N(t)) \end{cases} \quad (2)$$

The main difficulty concerns the distributor mass flow rate modelling, q_m , described in the next part.

2.2 On/off distributor

The distributor used in this work is a 5 way / 3 position, centre position closed (from the Asco Joucomatic company) (Fig. 2a). Both components are supposed to be identical. There are two relays to move the spool to the left or to the right. These different positions allow the pressure to increase, decrease or stabilise in the chamber. According to classical hypothesis the establishment of flow is instantaneous, which means that the transient flows can be neglected, the modelling study of the distributor can be split into two parts : a static part giving the mass flow rate as a function of the distributor spool position x and of the output port pressure p ($q_m(x, p)$) and a dynamic part characterising the spool dynamic ($x(U_P, U_N, t)$). Figure 2b shows the system representation of the distributor model.

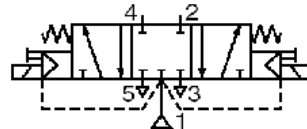

a/ Normalised representation of the distributor used

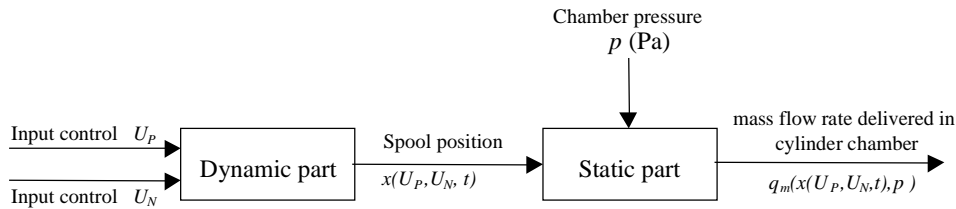

b/ Block diagram of the distributor model

Figure 2: Distributor

2.2.1 Dynamic part

The main drawback of on/off distributors compared to servodistributors is their high opening and closing time. In addition, for the components tested, the time is different for opening and closing, the closing time being about double the opening time. This difference is due to the force used to carry out the operation. The opening is carried out with the electro-magnetic force and the source pressure, while the closing is done by the mechanical force of the return spring. So, the component is asymmetrical.

This property has been compensated experimentally by applying a voltage, for a small time, on the opposite relay of the distributor in order to accelerate the spool to change position (go back to the centre or to the opposite side). The time of applying the voltage was specified for each distributor and tuned experimentally.

When connecting the distributor to a pneumatic chamber, it has been seen that the low dynamic is mainly due to the delay of 15 ms originating from high dry friction forces. Moving the spool then takes a few milliseconds. So, for a first control model, the displacement of the spool is supposed to be instantaneous and the dynamic part of the distributor model is just modelled as a delay (Fig. 3). The sampling period noted T_{st} , is then chosen as 20 milliseconds to guarantee that at each sampling time, the spool is either in an extreme position or in the central position. So the normalised position x of the spool, has only 3 different values : $\{-1, 0, 1\}$.

The consequence of the delay is that the variation of the pressure in a chamber for a control at time kT_{st} depends on the previous position of the distributor spool produced by the previous control at time $(k-1)T_{st}$. It means that

the effective application of the control is delayed (Fig. 3). This problem has to be taken into account in the control algorithm.

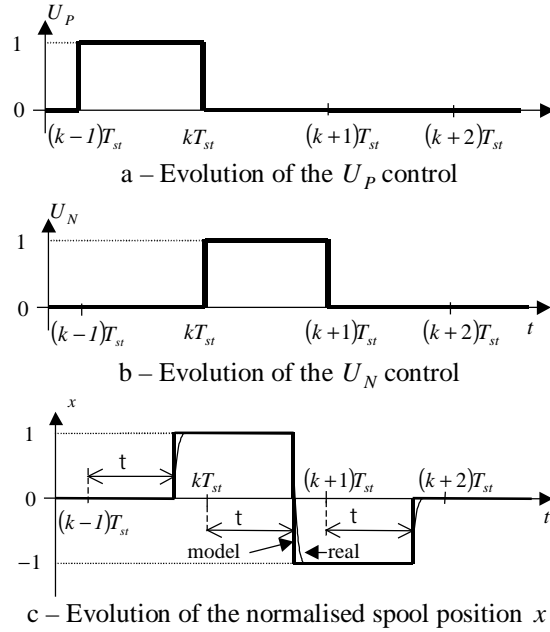

Figure 3: Example of the evolution of the normalised spool position of the distributor

According to the modelling hypothesis, the following dynamic model is then proposed with t being the time delay of the spool to change position when the control is applied :

$$x(U_p(kT_{st}), U_N(kT_{st}), t) = \begin{cases} U_p((k-1)T_{st}) - U_N((k-1)T_{st}) & \text{if } kT_{st} \leq t < kT_{st} + t \\ U_p(kT_{st}) - U_N(kT_{st}) & \text{if } kT_{st} + t \leq t < (k+1)T_{st} \end{cases} \quad (3)$$

With three possible states (Table 1) :

$$\begin{cases} U_p = 0 \\ U_N = 0 \end{cases} \quad \text{or} \quad \begin{cases} U_p = 1 \\ U_N = 0 \end{cases} \quad \text{or} \quad \begin{cases} U_p = 0 \\ U_N = 1 \end{cases}$$

2.2.2 Static part

The static part of the on/off distributor model should consist of the expression of the mass flow rate through each useful restriction as a function of the chamber pressure p and of the normalised spool position x . As for the determination of the dynamic model, it has been considered that the movement of the spool is instantaneous, it is just necessary to know the mass flow rate characteristics of the on/off distributor for the full opening of the useful restrictions. According to Fig. 1 and 2, these restrictions are :

- restrictions 1 to 4 ($x_p = 1$) and 4 to 5 ($x_p = -1$) for distributor 1,
- restrictions 1 to 2 ($x_N = -1$) and 2 to 3 ($x_N = 1$) for distributor 2.

According to the ISO 6358 [23] standard, a test bench was realised (see Fig. 4a) to measure the mass flow rate characteristics to determine the flow parameters b and C used by the standard approximation (4). This model gives the mass flow rate evolution as a function of the upstream pressure and temperature and of the downstream pressure defined along the flow in the restriction.

Figure 4b shows an example of the experimental characteristics obtained compared to those obtained from the identified b and C parameters according to the ISO 6358 standard [23].

$$\begin{aligned}
 &\text{if } \frac{P_{DOWN}}{P_{UP}} \leq b \quad (\text{sonic flow}), \quad q_m(p_{UP}, p_{DOWN}) = Cr_0 p_{UP} \sqrt{\frac{T_0}{T_{UP}}} \\
 &\text{if } b < \frac{P_{DOWN}}{P_{UP}} \leq 1 \quad (\text{subsonic flow}), \quad q_m(p_{UP}, p_{DOWN}) = Cr_0 p_{UP} \sqrt{\frac{T_0}{T_{UP}}} \sqrt{1 - \left(\frac{P_{DOWN} - b}{1 - b} \right)^2}
 \end{aligned} \tag{4}$$

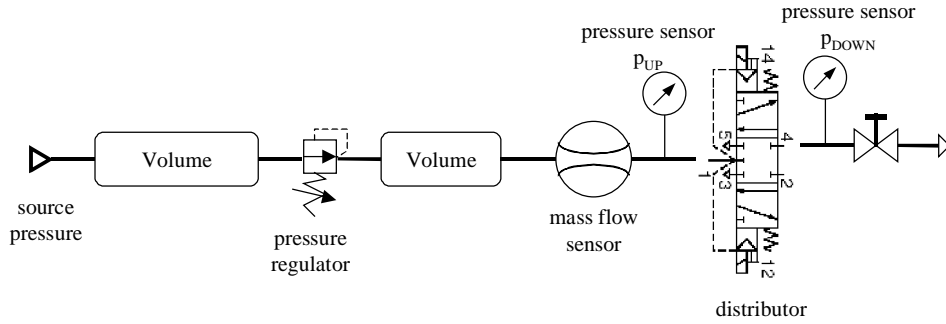

a/ Test bench for on/off distributor characterisation

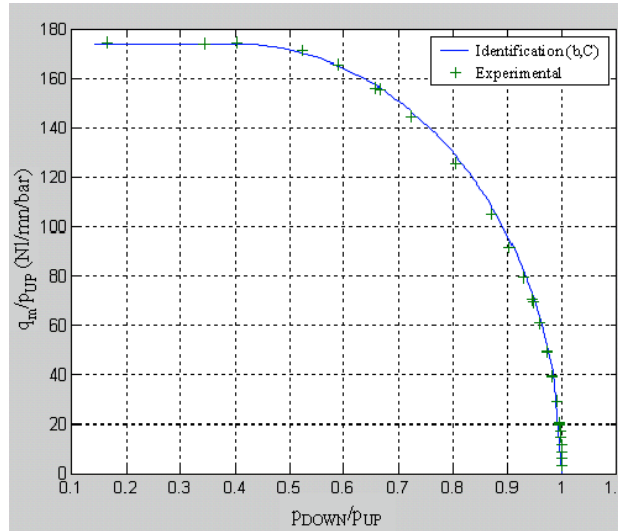

b/ Experimental and identified mass flow rate distributor characteristics

Figure 4: Distributor characterisation

As the four characteristics are very similar, the same couple of parameters (b,C) according to the ISO 6358 standard [23] has been determined for modelling every restriction :

- Critical pressure ratio $b = 0.4$,
- Sonic conductance $C = 174 \text{ NI/mn/bar}$

So the mass flow rates entering the 2 chambers can be expressed as a function of the spool position and of the chamber pressure by :

$$q_{m_p}(x_p, p_p) = \begin{cases} q_m(p_S, p_p) & \text{for } x_p = 1 \\ 0 & \text{for } x_p = 0 \\ -q_m(p_p, p_E) & \text{for } x_p = -1 \end{cases} \tag{5}$$

$$q_{m_N}(x_N, p_N) = \begin{cases} -q_m(p_N, p_E) & \text{for } x_N = 1 \\ 0 & \text{for } x_N = 0 \\ q_m(p_S, p_N) & \text{for } x_N = -1 \end{cases} \tag{6}$$

The q_m function in (5) and (6) is given by (4) in which the flow parameters b and C have the previous determined values and the upstream temperature is considered equal to the source temperature whatever the flow direction (according to hypotheses taken for the cylinder model section 2.1). The equations (3) to (6) enable knowledge of each variable appearing in the system to be obtained (2) which together define the global control model of the system presented in Fig. 1.

3. HYBRID CONTROL

3.1 Hybrid Control Principle

Hybrid control uses a hybrid model where the continuous state variables of the continuous sub-process depend on the energy modulator's configuration:

$$\dot{\underline{X}}(t) = f(\underline{X}(t), \underline{U}(t))$$

$\underline{X} \in \mathfrak{R}^n$ and $\underline{U}(t)$ is a m -dimensional vector that is finite

$$\underline{U} \in \{U_1, U_2, \dots, U_N\}, N \geq 2$$

For a short sampling period T_{st} , the model can be written as (Euler method):

$$\underline{X}(k+1) = \underline{X}(k) + f(\underline{X}(k), \underline{U}(k)) \cdot T_{st}$$

Assuming that full state is available for measurement, at time kT , the state $\underline{X}(k)$ is known. Via the dynamic model of the system (1), the state at time $(k+1)T_{st}$, noted $\underline{X}_j(k+1)$, $j \in N$, for each possible value of the control set can be calculated. N directions are defined as $\underline{d}_j = \underline{X}_j(k+1) - \underline{X}(k)$.

For a given reference state $\underline{X}^{\#}$, Hybrid Control consists of calculating the N possible directions of the continuous state vector evolution \underline{d} , choosing a control configuration in order to track this reference state in the state space. For the bi-dimensional example in Fig. 5, the desired value (target point) can be placed in the plane X_1 and X_2 . To track this reference, at each sample time, hybrid control proceeds as follows:

- it acquires the state of the system at time kT_{st} ($X_1(kT_{st})$ and $X_2(kT_{st})$) see Fig. 5)
- knowing the state of the system in the state space at time kT_{st} , this algorithm solves the system model equations, and calculates the different directions $\underline{d}_j, 1 \leq j \leq N$ of the continuous state vector evolution corresponding to the application of j^{th} configuration of the energy modulator (\underline{d}_1 to \underline{d}_5 in Fig. 5)
- knowing the target point, this algorithm selects the optimal configuration. For this many techniques are possible. For example, the configuration chosen can be the one that minimises the Euclidean distance between the different reachable points and the target point.
- this algorithm chooses the shortest Euclidean distance (\underline{d}_4 in Fig. 5) and the corresponding control (U_4) is applied to the energy modulators for all the sampling period.

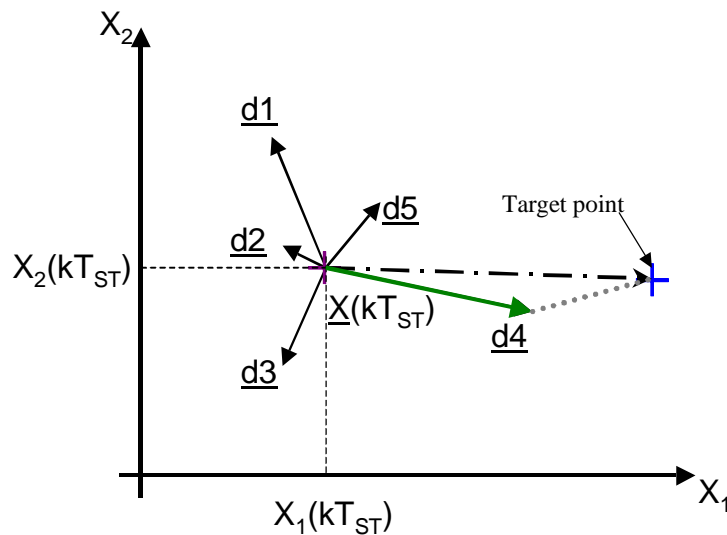

Figure 5: Principle of hybrid control

3.2 Application to the pneumatic system

3.2.1 Principle of the algorithm

For the system represented by Fig. 1, pressures in both chambers P and N constitute the state space $\underline{X}(t) = [p_p, p_n]^t$. The state space is of dimension 2, so it can be represented by a (p_n, p_p) plane. Two distributors enable three different states (pressure admission, closed and pressure exhaust) to be established leading to nine different control vectors C1 to C9 (see table 1).

The objective is, knowing the pressure at the sampling instant kT_{st} , to estimate the evolution of the pressures at the next sampling instant, $(k+1)T_{st}$, in both chambers P and N for the nine controls (C1 to C9) and then to choose the best control for reaching the desired force.

At each sample time, the pressure in each chamber is measured. The hybrid control algorithm calculates the nine directions $\underline{d1}$ to $\underline{d9}$ reachable at the next sample time in the state space by integrating the pressure differential system (2) using equations (3) to (6). See the block diagram in Fig. 6.

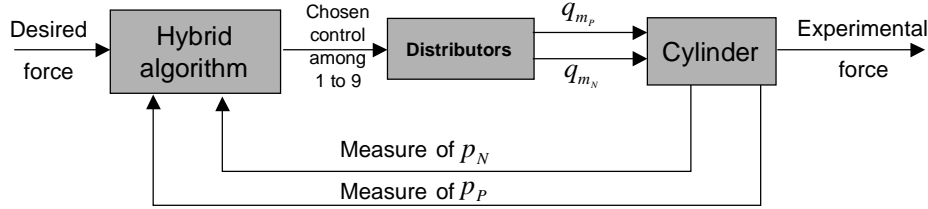

Figure 6: System structure

The target is fixed according to equation (1). For a given desired pneumatic force F , the target is defined by a one-dimensional equation:

$$p_p = \left(\frac{S_N}{S_P} \right) p_n + \left(\frac{F}{S_P} + \frac{S_P - S_N}{S_P} p_E \right) \quad (7)$$

So the target is a point of the straight line defined by equation (7) in the (p_n, p_p) plane. The algorithm calculates the nine possible directions ($\underline{d1}$ to $\underline{d9}$ in Fig. 7). Then it chooses the control configuration that corresponds to the lowest Euclidean distance in the physical domain ($d6$ for the desired force F1 and $d4$ for the desired force F2 in Fig. 7 because $d6$ leads out of the physical domain in this case).

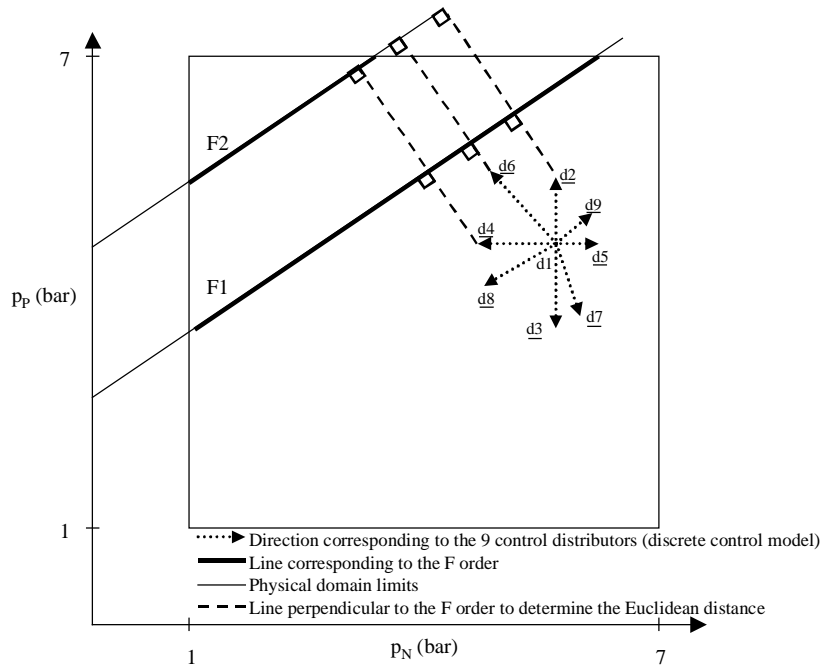

Figure 7 : Example of control choice

3.2.2 Principle of the modified hybrid algorithm

In this paper, a modified algorithm is proposed in order to achieve fast response without overshoot. Indeed, the hybrid control algorithm calculates the nine directions $d1$ to $d9$ reachable at the next sample time in the state space. The difference between the modified algorithm and the algorithm presented in the previous section is as follows:

- § All the commands which cross the line are not taken in consideration by the algorithm : if a direction crosses the line, it is forbidden ($d6$ in Fig. 8).
- § In the last step approaching the line the algorithm makes some adjustments to the time of the application of the command in order to reduce the steady state error. This adjustment is proportional to the distance between the line and the command (see Fig. 8).

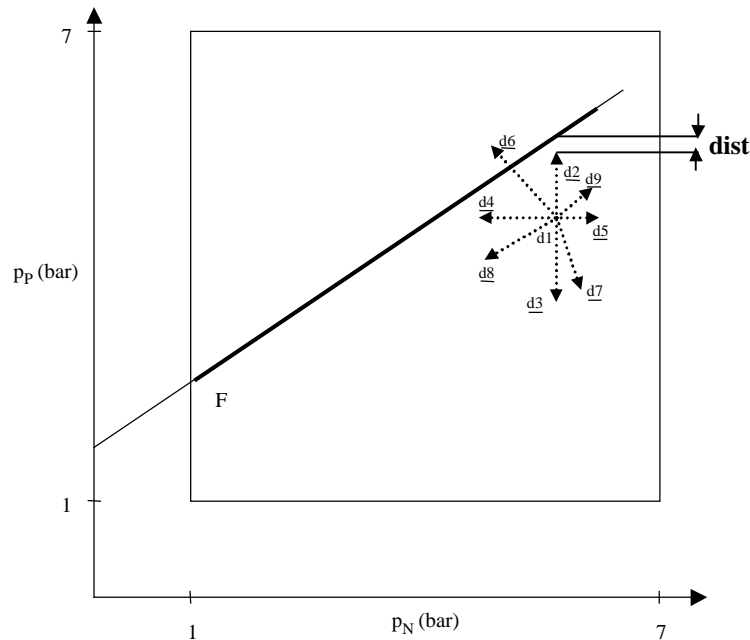

Figure 8 : Example of control choice

4. EXPERIMENTAL RESULTS

The proposed controller was implemented using a dSpace DS1104 controller board with a dedicated digital signal processor. Programs implemented in DS1104 were Matlab/Simulink ones with C code. Value 1 given by table 1 means that the relay of the distributor is supplied at 5V. Value 0 means 0V. The exhaust pressure value (1 bar) and the supply pressure (7 bar) limit the pressure. The desired force is 0N during 2.5 seconds and 260N during 2.5 seconds. At the beginning of the process, the pressure in the chamber P and N are equal to 1 bar.

This part will compare the two different algorithms. In the first plots (Fig. 9), the hybrid algorithm [4] is used. In the second plots (Fig. 10) the modified algorithm is used.

When the desired force becomes equal to 260 N, the control algorithms permit to increase the pressure in chamber P. An important overshoot of desired force can be seen in Fig. 9. A new control vector is selected by the hybrid control algorithm to decrease the force value and converges to the desired force. It is visible that the desired forces are quickly obtained but the steady state error is important (see time between 7 and 9 seconds in figure 9). Figure 10 clearly shows a reduction of the overshoot. This is due to the exclusion of a direction if it crosses the line. The adjustment of the time of the application of the command in the last step permit to reduce the steady state error.

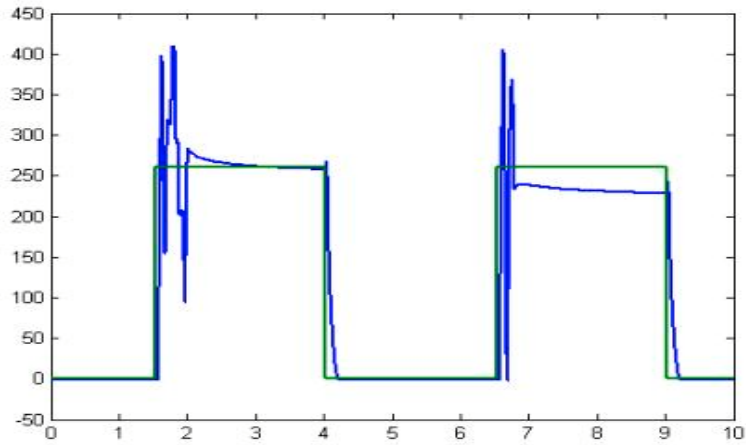

Figure 9 : Time evolution of the force (hybrid algorithm)

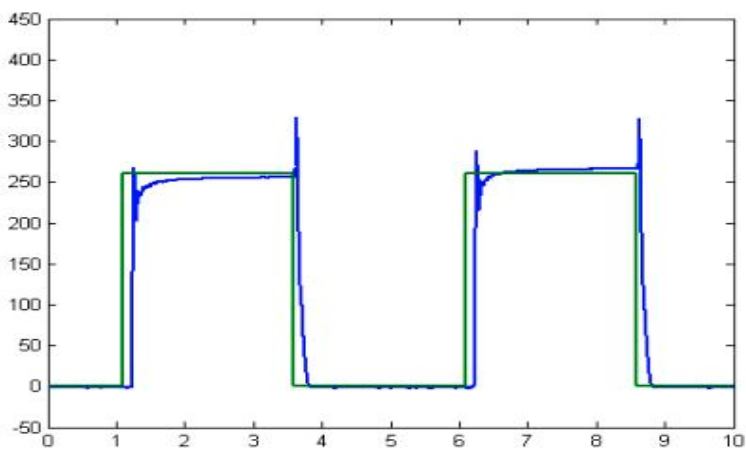

Figure 9 : Time evolution of the force (modified hybrid algorithm)

5. CONCLUSIONS

The contribution of this paper concerns the implementation of hybrid force controllers at low cost in pneumatic field. Firstly, the model synthesis and parameterisation of an on/off electropneumatic valve is presented. Secondly, the application of the hybrid method developed for electrical engine control [5, 6], of a system composed of a pneumatic cylinder and two on/off distributors designed for force control is studied. Two control algorithms are presented. Experimental results show that the principle of controlling the force by quantified components is realisable.

The main benefits of the modified hybrid algorithm are the reduction of the overshoot and the steady state error.

On/off control is a promising alternative for force control because of the low cost (compared to servodistributors) and the good performance obtained. Moreover there are no control parameters to tune. It is possible to improve the system in three different ways :

improvement of the control algorithm.

- add a closed loop by placing a force sensor at the end of the piston (to measure the force obtained) and to use a classical supplementary control loop as PID.
- to replace the distributors by ones which have a smaller sonic conductance C .

Future work will focus on improving the algorithm and applying a higher voltage to the distributor relay to reduce the spool delay.

Notation

b	critical pressure ratio
C	sonic conductance (Nl/mn/bar)
F	force (N)
S	piston cylinder area (m ²)
T	temperature (K)
T _{st}	sampling period (s)
U	boolean distributor input (null)
V	pneumatic cylinder chamber volume (m ³)
k	sampling period index
n	polytropic constant
p	pressure (Pa)
q _m	mass flow rate (kg/s)
r	perfect gas constant (J/kg/K)
t	time (s)
x	normalised position of the distributor spool (null)
τ	spool time delay to move after the control has been applied (s)
ρ	specific mass (kg/m ³)

Subscript and Superscript

UP	upstream
DOWN	downstream
P	relative to an increase of force
N	relative to a decrease of force
E	exhaust
S	supply
0	reference
1	distributor connected to chamber P
2	distributor connected to chamber N

References

- [1] Ham, R.V, Verrelst, B., Daerden, F., Vanderborght, B., Lefeber, D. 2005. *Fast and accurate pressure control using on/off valves*, International Journal of Fluid Power, Vol 6, N°1.
- [2] Van Varseveld, R.B., Bone, G.M. 1997. *Accurate position control of a pneumatic actuator using on/off solenoid valves*, Transactions on Mechatronics, IEEE/ASME, Volume 2, Issue 3, p 195-204.
- [3] Legrand X., Retif J.-M., Smaoui M., Brun X., Thomasset D., Lin-Shi X. 2005. *Hybrid control with on/off electropneumatic standard valve for tracking positioning*, Bath Worksh. on Power Transmission & Motion Control, England.
- [4] Sellier, A., Brun, X., Sesmat, S., Retif, J.M., Lin-Shi, X., Thomasset, D., Smaoui, M., *Hybrid Force control with on/off electro-pneumatic standard distributors*, Journal of Fluid Power, Vol 7, N°1, March 2006, p 51-59.
- [5] Retif, J.M., Lin-Shi, X.F., Llor, A., Arnalte, S. 2004. *New control for a synchronous machine, the hybrid control*, EPE-11th International Power Electronics and Motion Control Conference.
- [6] Retif, J.M., Lin-Shi, X.F., Llor, A. 2004. *A new hybrid direct-torque control for a winding rotor synchronous machine*, PESC'2004: 35th IEEE Power Electronics Specialists Conference.
- [7] Ben-Dov, D., Salcudean, S.E. 1995. *A force controlled pneumatic actuator*, IEEE Transactions on Robotics and Automation, Vol 11, Issue 6, p 906-911.
- [8] Edge, K.A, Figeredo, K.R.A. 1987. *An adaptively controlled electrohydraulic servo-mechanism: Part 1: Adaptive controller design - Part 2: Implementation*. In: Proc. Instn. Mech. Engrs. Part B, Vol 201, N°3, p 175-180 and p. 181-189.
- [9] Richer, E., Hurmuzulu, Y. 2000. *A high performance pneumatic force actuator system : Part I – Nonlinear Mathematical Design, Part II – Nonlinear Controller Design*, Journal of Dynamic Systems Measurement and Control, Volume 122, Issue 3, p 416-425 and p 426-434.
- [10] Yamada, H., Kudomi, S., Muto, T. 2003. *Development of a pneumatic force display (application to a master slave system)*, International Journal of Fluid Power, Vol 4, n°1.
- [11] Yin, Y.B., Araki, K. 1998. *Modelling and analysis of an asymmetric valve controlled single-acting cylinder of a pneumatic force control system*, SICE'98. Proceedings of the 37th SICE Annual Conference, Chiba, Japan, p 1099-1104.
- [12] Morel, F., Retif, J.M., Lin-Shi, X.F., Llor, A. 2004. *Fixed switching frequency hybrid control for a permanent synchronous machine*, IEEE International Conference on Industrial Technology (ICIT'04), Tunisia.

- [13] Burrows, C.R. 1972. *Fluid Power Servomechanisms*. London : Van Nostrand Reinhold Company, 237 p.
- [14] Parnichkun, M., Ngaecharoenkul, C. 2001, *Kinematics control of a pneumatic system by hybrid fuzzy PID*, Mechatronics, Vol 11, Issue 8, p1001-1023
- [15] Belforte, G., Mauro, S., Mattiazzo, G. 2004. *A method for increasing the dynamic performance of pneumatic servosystems with digital valves*, Mechatronics, Vol 14 Issue 10, p 1105-1120
- [16] Noritsugu, T., Wada, T., Yanosaka, M. 1988. *Adaptive control of electropneumatic servo system*. In: 2nd Int. Symp. On Fluid -Control, Measurement, Mechanics and flow visualisation. Sheffield, England, p. 285-289.
- [17] Brun, X., Thomasset, D., Bideaux, E. 2002. *Influence of the process design on the control strategy: application in electropneumatic field*, Control Engineering Practice, Volume 10, Issue 7, p 727-735.
- [18] Bouri, M., Thomasset, D., Scavarda, S. 1996. *Integral sliding mode controller of a rotational servodrive*. Third Japan Hydraulics and Pneumatics Society, Tokyo, p 145-150.
- [19] Liu, P., Dransfield, P. 1993. *Intelligent control of air servodrives using neural networks*. Proc. of Second Japan Hydraulics and Pneumatics Society, Tokyo, p. 381-399.
- [20] Brun, X., Thomasset, D., Scavarda, S. 2003. *Hybrid control for switching between position and force tracking*, The Fourth International Symposium on Fluid Power Transmission and Control, Wuhan, China.
- [21] Shearer, J.L. 1956. *Study of pneumatic processes in the continuous control of motion with compressed air*. Parts I and II. Trans. Am. Soc. Mech. Eng., Vol. 78, p.233-249.
- [22] Andersen, B.W. 1967. *The analysis and design of pneumatic systems*. New-York : John Wiley and Sons, 302p.
- [23] International Standard ISO Norm 6358 1989. *Pneumatic Fluid Power- Components Using Compressible Fluids, Determination of Flow-rate Characteristics*.