



**HAL**  
open science

## **Radio direction finding applied to DVB-T network for vehicular mobile reception**

Franck Nivole, Christian Brousseau, Stéphane Avrillon, Dominique Lemur, Louis Bertel

### ► **To cite this version:**

Franck Nivole, Christian Brousseau, Stéphane Avrillon, Dominique Lemur, Louis Bertel. Radio direction finding applied to DVB-T network for vehicular mobile reception. 3rd European Conference on Antennas and Propagation, Mar 2009, Berlin, Germany. pp.1-6. <hal-00398677>

**HAL Id: hal-00398677**

**<https://hal.science/hal-00398677v1>**

Submitted on 25 Jun 2009

**HAL** is a multi-disciplinary open access archive for the deposit and dissemination of scientific research documents, whether they are published or not. The documents may come from teaching and research institutions in France or abroad, or from public or private research centers.

L'archive ouverte pluridisciplinaire **HAL**, est destinée au dépôt et à la diffusion de documents scientifiques de niveau recherche, publiés ou non, émanant des établissements d'enseignement et de recherche français ou étrangers, des laboratoires publics ou privés.



HAL Authorization

# Radio direction finding applied to DVB-T network for vehicular mobile reception

F. Nivole, C. Brousseau, S. Avrillon, D. Lemur, L. Bertel

*Institut d'Electronique et de Télécommunications de Rennes, Université de Rennes 1, France*

Christian.brousseau@univ-rennes1.fr

**Abstract**— To improve the quality of the mobile reception of DVB-T (Digital Video Broadcasting - Terrestrial) signal, the knowledge of the propagation channel characteristics is necessary. In this aim, this paper presents sounding methods and results for the estimation of Direction of Arrival (DoA) of DVB-T signals in mobile receiving configuration. The mobile passive sounder is presented, including post-processing and radio direction finding tools. Then, results in different kinds of environment (rural area, motorway, low density and high density town centres) are given and discussed.

## I. INTRODUCTION

The aim of the CAVITE project [1] is to improve the reception of DVB-T signal in mobile conditions (car, train ...) characterized by important propagation effects (Doppler, delay spread ...). The first step of this project is to evaluate the spatial and time propagation channel characteristics, to ensure that diversity exists and that it could be exploited to increase the quality of received images on vehicular board.

DVB-T system uses COFDM transmission. This modulation is suitable to high numerical data rate transmission but is very sensitive to Doppler frequency shift, noise and fading effects. One way to improve the DVB-T reception for mobile application is to use heterogeneous antenna array [1]. The choice of these antennas is critical and it is necessary to have a good knowledge of propagation channel effect. In particular, the estimation of the Direction of Arrival (DoA) allows to define the features of the antennas and their location on the vehicle, and the characteristics of diversity receiver.

## II. MULTI-ANTENNA MOBILE SOUNDER AND SIGNAL PROCESSING

The challenge for channel sounding is to get information from broadcasted DVB-T received signals with an omnidirectional angular span, under fading condition, horizontal polarization and antennas mounted on a car roof.

A 4-inputs antenna coherent receiver, including a radio frequency (RF) front-end and baseband signal processing, has been developed in IETR laboratory.

### A. RF front-end

As shown on Fig. 1, the RF front-end includes:

- Omnidirectional antennas,
- RF filters centred at 650 MHz,
- Low Noise Amplifiers (LNA),
- Frequency mixers with 36.125 MHz Intermediate Frequency (IF),
- IF amplifiers,

- IF SAW filters with 8 MHz bandwidth,
  - 100 Ms/s high speed data acquisition.
- Omnidirectional antennas are constituted with pairs of printed halo antennas and are set as a circular array mounted on car roof [2].

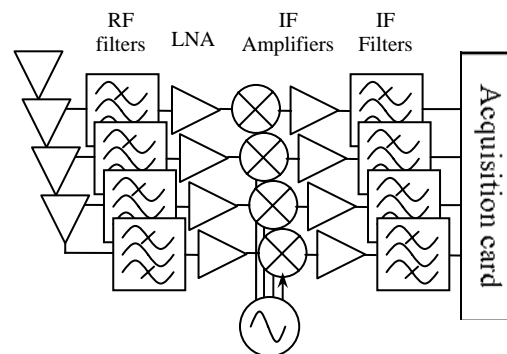

Fig. 1 Receiving RF front-end architecture used for the DVB-T channel sounder.

### B. Baseband signal processing

Estimations of directions of arrival are computed using impulse responses from the four coherent receiving channels. These channel impulse responses are obtained from the structure of DVB-T frame (see Fig. 2) using baseband signal processing [3] that includes:

- OFDM coarse-synchronization, phase offset correction and fine synchronization,
- Static and scattered pilot recovery for channel frequency estimation and signal equalization,
- Estimation of channel impulse response from frequency channel interpolated information.

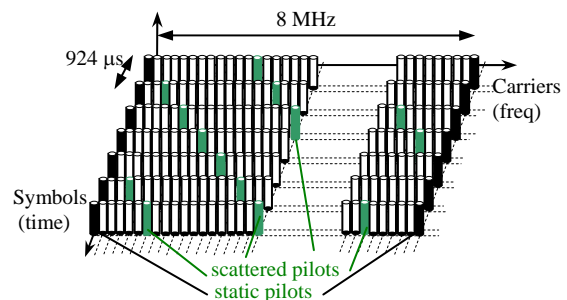

Fig. 2 DVB-T frame structure with static and scattered pilots positions as a function of frequency and symbol time.

A photo of the receiving and acquisition system is given in Fig. 3.

### III. FIELD TESTS



Fig. 3 Receiving and acquisition system

#### C. DoA estimation methods

Two different methods Capon [3] and MUSIC [5] are used to estimate directions of arrival from measured impulse responses.

##### 1) Capon method

The Capon method algorithm uses the covariance matrix of channel impulse response samples  $X$ :

$$R_{XX} = \frac{1}{N} \sum_{n=1}^N X(n)X(n)^T \quad (1)$$

Where  $n$  is the sample number,  $N$ , the number of samples, and  $(\cdot)^T$ , the transposition.

Then, the Capon spectrum is given by:

$$P_{\text{capon}}(Az, El) = \frac{1}{a(Az, El)^T \cdot R_{XX} \cdot a(Az, El)} \quad (2)$$

Where  $Az$  is the azimuth angle,  $El$ , the elevation angle, and  $a$ , the steering vector of the antenna array.

##### 2) MUSIC high resolution algorithm

This algorithm uses an Eigen-decomposition of the covariance matrix  $R_{XX}$  given in equation (1). The aim is to separate the samples in two orthogonal subspaces. The first is the noise subspace and the second is the signal one.

After the Eigen-decomposition, the number of sources  $NSE$  is evaluated by most important Eigen values. Then, a pseudo spectrum  $PSSP$  is determined using the normalized steering vector  $b(Az, El)$  of antenna array.

It is given by:

$$PSSP(Az) = \frac{1}{\sum_{k=NSE+1}^{NC} |v_k^T \cdot b(Az, El)|} \quad (3)$$

Where  $NC$  is the number of sensors,  $k$ , the sensor number,  $v_k^T$ , the Eigen-vector, and  $b = a/(NC)^{1/2}$ , the normalized steering vector.

The maximum as a function of azimuth and elevation angles gives the DoA of DVB-T propagation paths.

#### D. Measurement setup

For the measurements, a car has been equipped with the 4 inputs diversity receiver and the antennas have been mounted on the vehicle in a roof box. Figure 4 shows the embedded mobile system inside the car. Figure 5 gives the reference azimuth and elevation regarding the vehicle orientation. A GPS receiver records the vehicle routes during measurements.

Field tests have been performed in four different environments, three in Brittany (France): motorway, rural area, low density town centre, and one in Paris (France): high density town centre.



Fig. 4: Photo of the embedded system inside the car.

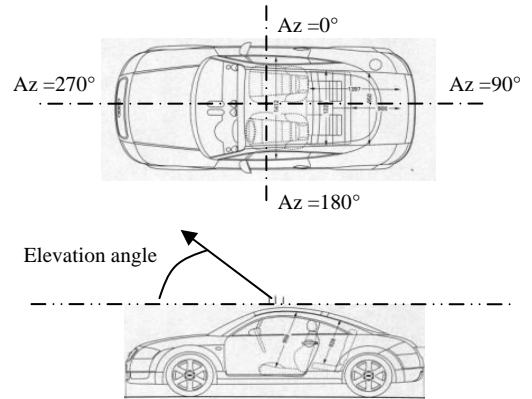

Fig. 5: Car representation in azimuth and elevation plan.

##### 1) Brittany measurement setup

In Brittany, the receiver is set up to receive signals from the Rennes/St Pern transmitter. Figure 6 shows the routes, the transmitter location, and the direction of vehicle along these routes. In these three cases, direction of vehicle in relation to transmitter has very little variation along each route. Speed limit is set to 110 km/h in motorway area, 90 km/h in rural area, and 50 km/h in low density town center.

##### 2) Paris measurement setup

In Paris, the receiver is set up to receive signals from the Eiffel tower transmitter. Figure 7 shows the routes, the transmitter location, and the direction of vehicle along these routes. Speed limit is 50 km/h in Paris.

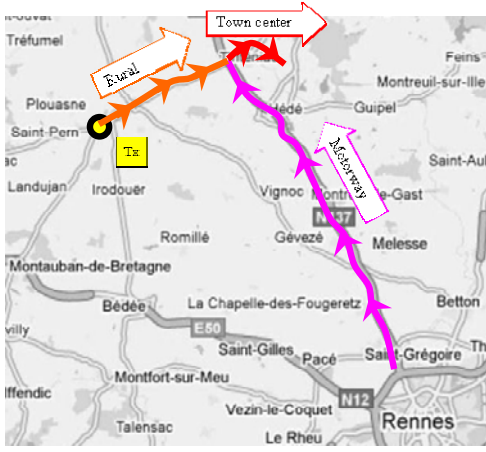

Fig. 6: Route of mobile measurements recorded by the GPS receiver in Brittany (north of Rennes)

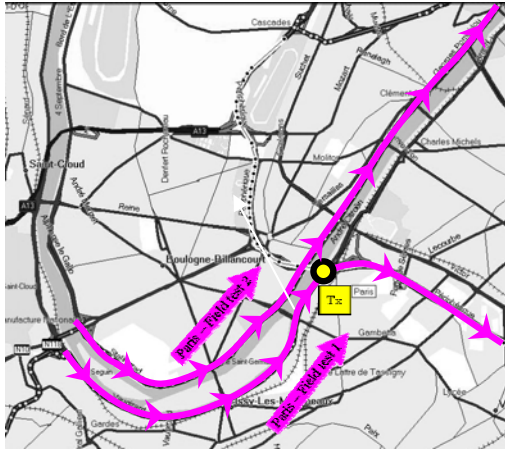

Fig. 7: Route of mobile measurements recorded by the GPS receiver in Paris.

### E. Channel impulse responses

Two types of channel impulse responses have been obtained during measurements. For measurements in Brittany, only one path has been observed in channel impulse response, as shown in fig. 8. In Paris, multi-paths have been observed, as shown in fig. 9 and, most of the time, two paths are relevant. So, in these cases, estimations of angles of arrival are given for the two paths in the following section.

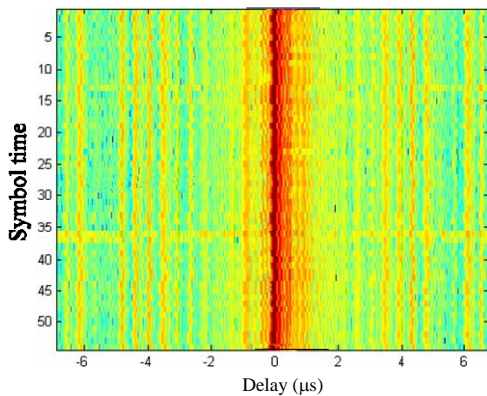

Fig. 8: One path channel impulse response in low density town centre as a function of delay and symbol time.

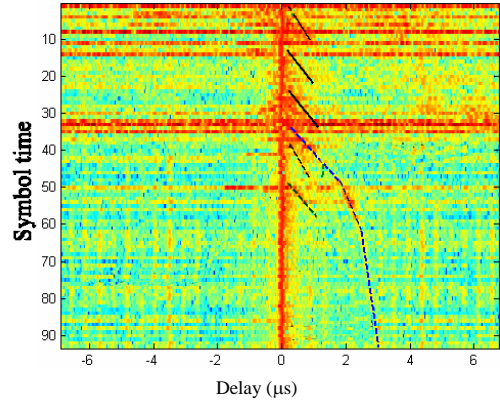

Fig. 9: Multipaths channel impulse response measured in Paris as a function of delay and symbol time. Main path is obtained at 0ms and multiple second paths appear at different symbol time (black lines).

## IV. RESULTS OF DOA ESTIMATION AND COMMENTS

Figures 10 to 12 give azimuth and elevation DoA estimations using the two methods (Capon and MUSIC) for the three different environments in Brittany: motorway, rural area, and low density town centre. Figures 13 to 16 give azimuth and elevation DoA estimations using the two methods (Capon and MUSIC) for the two paths detected during the two field tests in Paris. All these results are represented using a polar graph that gives statistical counting of DoA estimations, in twenty 18°-angular sectors in both azimuth and elevation planes, made during a large number of DVB-T symbols (from 200 to 450 depending on the measurements). Results with elevation lower than 18° for all symbols have not been represented in the figures.

### A. Brittany measurement results

For the three measurements realized in Brittany, results are quite similar. Figures 10, 11, and 12, show that angles of arrival are limited to a reduced angular sector, typically less than 60° in azimuth plane and less than 40° in elevation plane. Azimuth angle is around 230° during motorway measurements and 90° during rural and low density town centre measurements. These angles correspond with the direction of Rennes/St Pern transmitter so that the vehicle is in Line of Sight (LoS) configuration for the three measurements.

In the three measurements realized in Brittany, Capon and MUSIC methods give very similar results. This is probably due to LoS configuration that provides high signal to noise ratio and permits to easily separate noise and signal orthogonal subspaces in MUSIC algorithm.

### B. Paris measurement results

In Paris, DoA estimations results are very different from Brittany results. Azimuth angular spread is wider, from 60° to 150° and elevation angular spread can be higher than 60°.

For field test 1, the first path (Fig.13) is spread between 60° and 120° in azimuth plane and between 0° to 60° in elevation plane. Capon and MUSIC give similar results in this case. The second path (Fig. 14) has a wider angular spread in azimuth, with two most important directions around 220° and around 300°.

For field test 2, the first path (Fig.15) has two most important angular directions in azimuth plane spread around  $60^\circ$  and  $120^\circ$  using Capon method and spread around  $45^\circ$  and  $130^\circ$  using MUSIC algorithm. In elevation plane, a wide spread is also observed from  $0^\circ$  to  $60^\circ$ . The second path (Fig. 16) has a wide angular spread in azimuth from  $230^\circ$  to  $360^\circ$  using Capon method but a smaller spread in elevation plane with angles less than  $20^\circ$ .

In the measurements realized in Paris, Capon and MUSIC methods do not generally give the same results. This is probably due to the high number of multipaths that reduces signal to noise ratio and does not permit to easily separate noise and signal orthogonal subspaces in MUSIC algorithm.

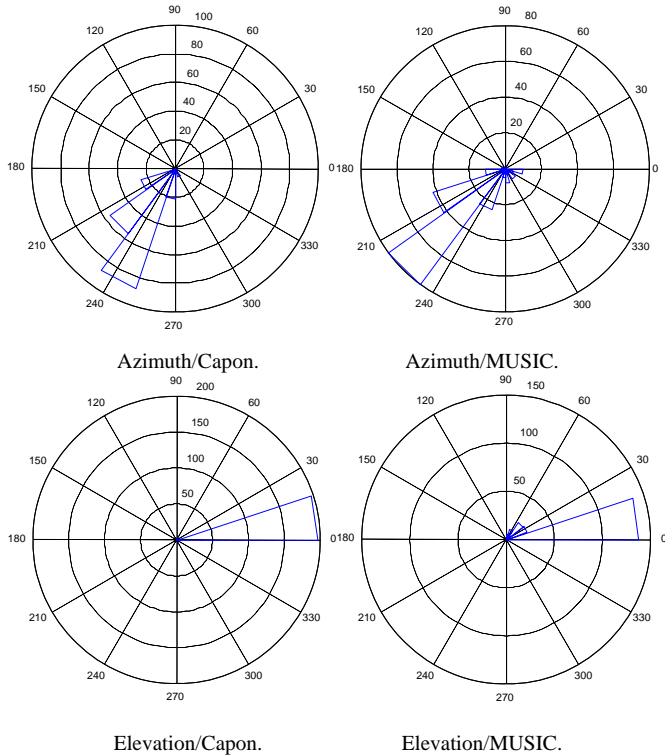

Fig. 10: Azimuth and elevation angle estimations in motorway area.

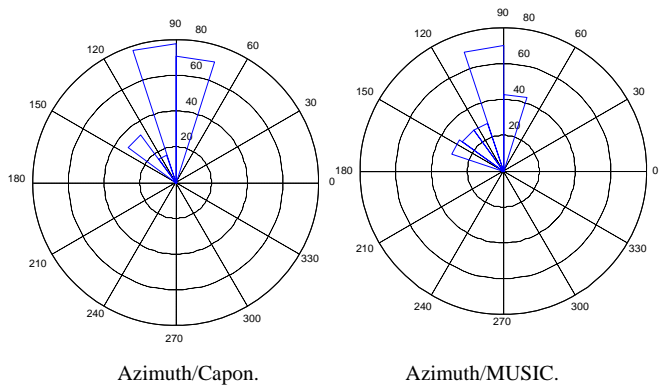

Fig. 11: Azimuth angle estimations in rural area.

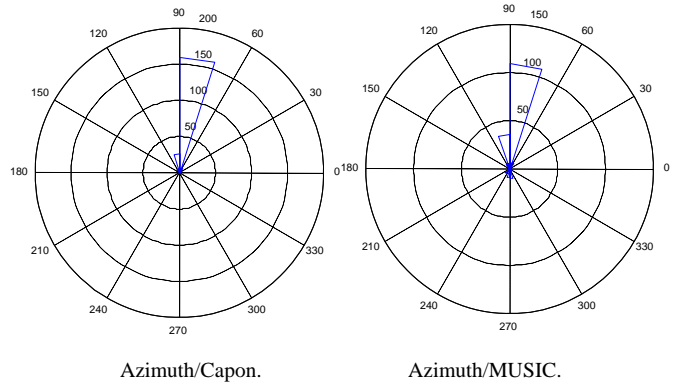

Fig. 12: Azimuth angle estimations in low density town centre.

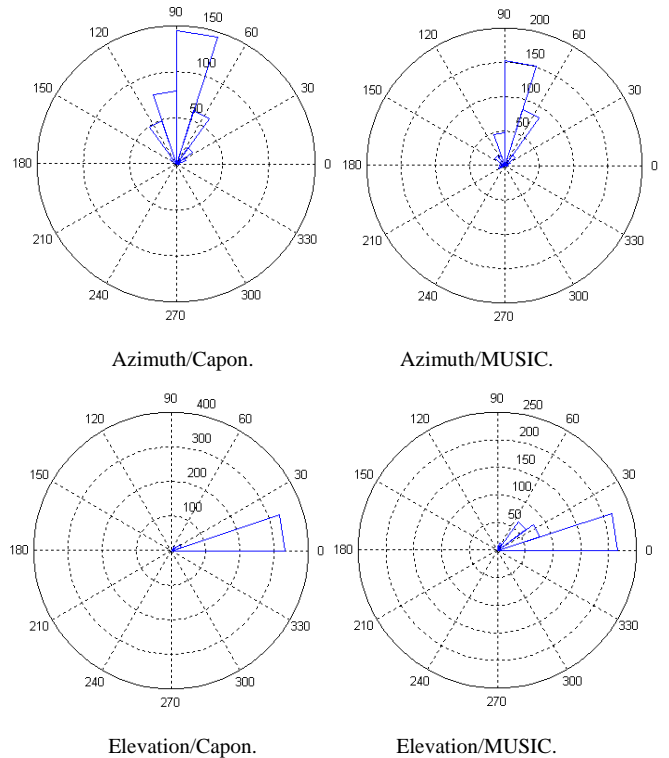

Fig. 13: Azimuth and elevation angle estimations in Paris (field test 1), for the first path.

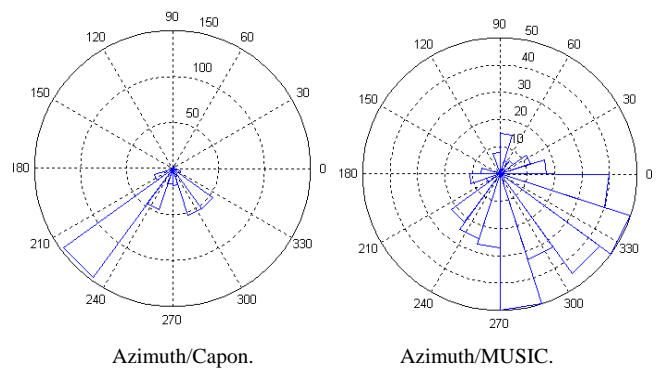

Fig. 14: Azimuth angle estimations in Paris (field test 1), for the second path.

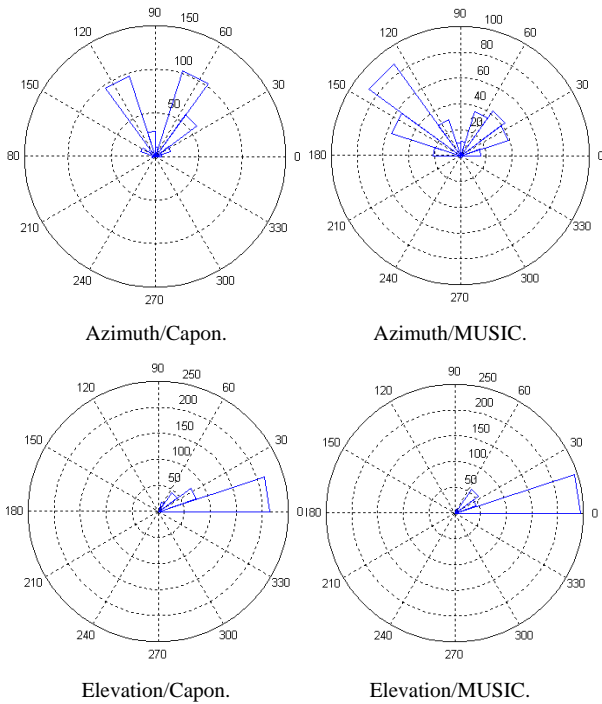

Fig. 15: Azimuth and elevation angle estimations in Paris (field test 2), for the first path.

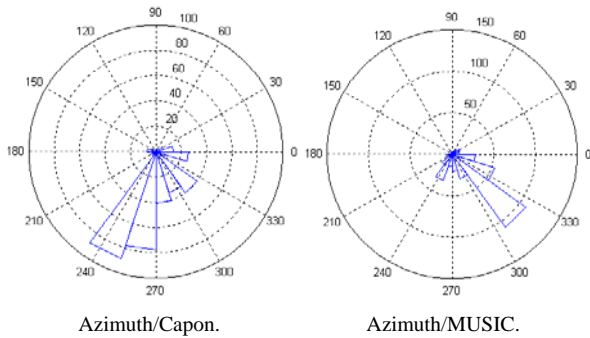

Fig. 16: Azimuth angle estimations in Paris (field test 2), for the second path.

### C. Comments on measurement results

Measurements in Brittany and in Paris give very different DoA estimation results. In Brittany, the environments chosen for these tests are free of reflexion and/or diffraction mechanism because of the absence of high buildings or obstacles. In these LoS configurations, angular spreads of DoA are very low. In Paris, the presence of high buildings and the very high density of the town introduce multi-paths with high angular spreads. However, in most of high spread DoA estimations (Fig.14 and Fig. 15), two main directions can be observed. This is probably due to urban-canyon phenomena in which waves can propagate only in very few directions which correspond to buildings alignment.

In high density environments like town centres, the high angular diversity is suitable with receivers using EGC (Equal Gain Combining) or MRC (Maximum Ratio Combining) with omni-directional antennas or wide-sectorial antennas.

In other environments where angular diversity is lower, omni-directional reception can be improved by using beamforming process that can be used to have better gain in

one direction and to focus the wave energy. Other solution is to use several high gain directional antennas which have to be distributed to cover the  $360^\circ$  angular span, with a switched antenna diversity algorithm. In this case, multi-receiver system does not need to use all synthesizers at the same time. The consumption will be reduced but a regular scan to get quality of signal has to be done to choose the antenna which has to be used with its respective receiver.

## V. CONCLUSIONS

A channel sounder for DVB-T network has been presented. It is constituted with four coherent receivers which permit to exploit DVB-T broadcasted signals in order to estimate directions of arrival. RF front-end, acquisition system, and baseband signal processing have been entirely developed in IETR laboratory. Direction of Arrival (DoA) estimations have been obtained from channel impulse responses using two different methods: Capon method and MUSIC algorithm.

DoA estimations have been performed during several field tests in four different environments: motorway, rural area, low density town centre, and high density town centre (Paris). Results of DoA estimations in Paris show that angular spread is important, both in azimuth and elevation plane, and that urban-canyon phenomena can reduce this angular spread around two main directions. In the other environments, the vehicle is in LoS configuration with only one low angular spread path in the direction of the transmitter.

This radio direction finding applied to DVB-T signal in vehicular condition permits to validate that two types of reception principles would be optimal: an antenna combining receiver with omnidirectional or wide-sectorial antennas in high density environments, and beamforming or switched antenna receiver with narrow-sectorial antennas in other environments.

## ACKNOWLEDGMENT

The authors thank the council of Brittany - France (Conseil Régional de Bretagne) and the FNADT (Fonds National d'Aménagement et de Développement du Territoire) for their supports to this project.

## REFERENCES

- [1] C. Brousseau, S. Avrillon, F. Nivole, L. Bertel, "Vectorial characterization of DVB-T propagation channel – Application to radio-mobile communications: the "CAVITE" Project", *EUCAP2007*, Edinburgh, UK, Nov. 2007.
- [2] F. Nivole, C. Brousseau, S. Avrillon, D. Lemur, F. Marie, L. Bertel, "Comparison of antenna performances for COFDM DVB-T system – Application to channel sounding", *EUCAP2007*, Edinburgh, UK, Nov. 2007.
- [3] P. Combelles, C. Del Toso, D. Hepper, D. Legoff, J-J. Ma, P. Roberston, F. Scalise, L. Soyer, and M. Zamboni, "A receiver architecture conforming to the OFDM based digital video broadcasting standard for terrestrial transmission (DVB-T)", *IEEE International Conference on Communications – ICC'98*, Torino, Italy, June 1998.
- [4] J. Capon, "Maximum-likelihood spectral estimation", Springer-Verlag, 1979.
- [5] R.O. Schmidt, "Multiple emitter location and signal parameter estimation", *IEEE Transactions on Antennas and Propagation*, Vol. AP-34, N°3, March 1986.