



HAL
open science

A CAD APPROACH OF MICROWAVE OPTICAL SYSTEMS INCLUDING NOISE PERFORMANCE

Houda Brahim, Horacio Luis Martinez-Reyes, Pierre-Henri Merrer, Aude Bouchier, Olivier Llopis

► **To cite this version:**

Houda Brahim, Horacio Luis Martinez-Reyes, Pierre-Henri Merrer, Aude Bouchier, Olivier Llopis. A CAD APPROACH OF MICROWAVE OPTICAL SYSTEMS INCLUDING NOISE PERFORMANCE. The European Microwave Week 2009, Sep 2009, Rome, Italy. 4p. hal-00395177

HAL Id: hal-00395177

<https://hal.science/hal-00395177v1>

Submitted on 15 Jun 2009

HAL is a multi-disciplinary open access archive for the deposit and dissemination of scientific research documents, whether they are published or not. The documents may come from teaching and research institutions in France or abroad, or from public or private research centers.

L'archive ouverte pluridisciplinaire **HAL**, est destinée au dépôt et à la diffusion de documents scientifiques de niveau recherche, publiés ou non, émanant des établissements d'enseignement et de recherche français ou étrangers, des laboratoires publics ou privés.

A CAD APPROACH OF MICROWAVE OPTICAL SYSTEMS INCLUDING NOISE PERFORMANCE

H. Brahim, H.L. Martinez-Reyes, P.H. Merrer, A. Bouchier, O. Llopis

LAAS-CNRS ; Université de Toulouse ; 7 avenue du Colonel Roche, F-31077 Toulouse, France

hbrahim@laas.fr

llopis@laas.fr

Abstract— A technique for the simulation of a microwave optical system is described. This technique, based on microwave CAD software, allows the simulation of the gain and noise performance. The optical devices are described using either an equivalent circuit approach or equation based models. The simulations of a simple RF optical link and of a more complex system, a microwave optical delay line frequency discriminator, are presented.

I. INTRODUCTION

Optical devices are more and more used in microwave systems, taking benefit of the low losses of the optical fibers, of their small size and their immunity to electrical parasitic signals. An example of these systems is the microwave optical oscillator, either based on optical resonators or delay lines, which can deliver ultra high spectral purity signals [1].

However, the performance of these systems is dependent on the performance of the devices used for the electrical to optical or optical to electrical conversions, on the chosen optical modulation technique, on the necessary microwave amplifiers, on the devices biasing circuits, on the quality of the optical fiber and, above all, on the topology chosen to build the whole system. It is thus important to be able to compute the system phase noise using an appropriate modelling approach. This analysis will allow us to understand where are located the main noise sources in the system, and how to improve the system performances by reducing these noise sources or their impact on the phase noise.

Specific microwave circuit design softwares have been designed in the 90s in order to take into account the frequency conversion phenomena between noise sidebands around the different harmonics of the RF signal (including DC) [2]. These softwares may be used to simulate the microwave parts of a microwave optical system. However, they generally do not include any specific model for the optical devices involved in these systems. A solution to this problem is in finding a representation of these devices which can be implemented in the microwave simulator, using either an equivalent electrical circuit or a mathematical model.

II. STUDY OF AN MZ BASED OPTICAL LINK: RF GAIN

The approach described in the part I has been implemented on a commercially available microwave simulation software: Agilent ADS.

In a first step, we began simulating a Mach Zehnder (MZ)

based optical link. In the MZ modulator, the nonlinearity due to the $1+\cos(x)$ optical response (x being the DC bias) leads to a saturation phenomenon which depends on the parameters of this curve: maximum optical power and maximum power voltage V_0 and extinction voltage V_π (see Figure 1).

These parameters are the input parameters of our MZ CAD model, as well as its frequency response which is modelled using a low pass filter on the modulator RF input port.

In our MZ based systems, we use two different types of modulation: the classical linear modulation (LM) and the optical carrier suppression (double sideband carrier suppression, or DSB-CS), which results in a frequency doubling of the RF signal. The last modulation type requires a high level of RF input power, but is more efficient in terms of signal to noise ratio if such an RF power is available [3], [4]. In the classical linear modulation, the MZ modulator is biased at $(V_0+V_\pi)/2$, while in the optical carrier rejection mode, it is biased at V_π .

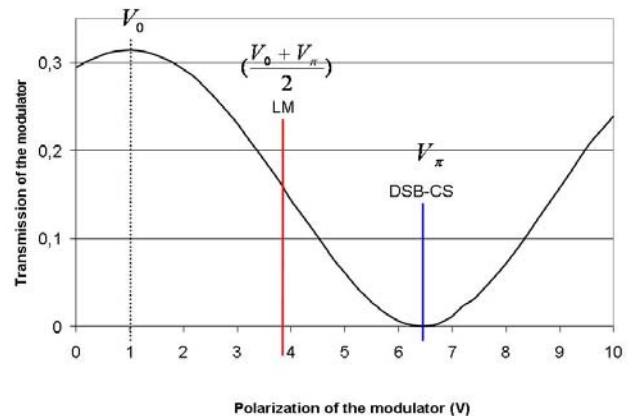

Fig. 1 MZ modulator optical power response versus DC bias voltage, and bias points for RF modulation

The optical source is described using a conventional RF source model of ADS (with a frequency of 200 THz !), and each optical element is described using ideal RF elements, such as ideal transmission lines.

Concerning the MZ modulator, it is described using an equivalent black box nonlinear equation SDD (Symbolically Defined Device). This SDD receives the optical signal from the laser on one input port, and the RF signal and the DC bias on the other input port. It performs the computation of the main system equation (1) which describes this device.

$$P_{opt} = \frac{P_{las} \cdot L_{ins}}{2} \left(1 + \eta \cos\left(\pi \left(\frac{V_{DC} - V_0}{V_{\pi DC}} + \pi \frac{V_{RF}(t)}{V_{\pi RF}(f)} \right) \right) \right) \quad (1)$$

P_{opt} being the optical power received by the photodiode, P_{las} the laser output power, L_{ins} the optical insertion losses, η the MZ extinction ratio, V_{DC} the MZ bias and V_{RF} the RF signal.

At the other side of the optical link, the photodiode is described as a quadratic detector using a nonlinear voltage controlled current source, and a low pass filter is added to take into account its frequency response.

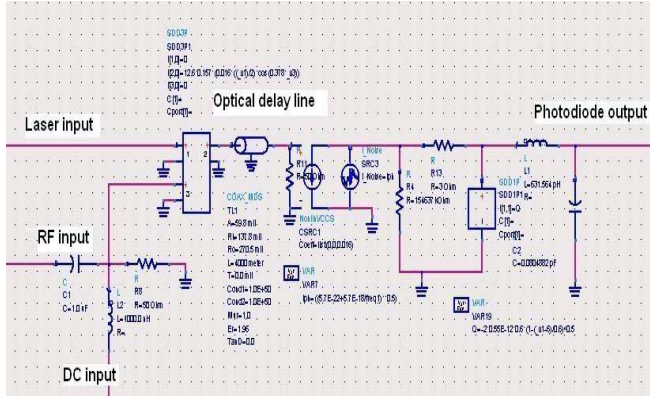

Fig. 2 SDD model of the MZ modulator and photodiode model

The optical interference inside the MZ modulator may also be described using an electrical phase modulator available in ADS library [10]. The main drawback of this technique comes from this circuit element which may only be used with an envelope simulation. The envelope technique is dedicated to the simulation of a slow varying signal superimposed to a fast signal, which is the case of the RF signal compared to the optical signal. However, in terms of noise, we will need the description of the noise conversions between the system three main frequencies: DC, RF and optical (see Figure 4) and the envelope simulator is not able to take into account three different frequency domains. Therefore, only the harmonic balance simulator is used in our simulations, and there are no fundamental differences in terms of computation between the system three main frequencies.

The result of an ADS simulation of the RF output power versus the RF input power for this optical link is depicted in Figure 3. The two studied modulation techniques have been plotted on the same graph: linear modulation (LM) and carrier suppression (DSB-CS). The RF input signal frequency is 10 GHz for the linear modulation and 5 GHz for the carrier suppression case (frequency doubling), and thus the RF output is at 10 GHz. The laser power is 10 dBm, which corresponds to a classical medium power telecommunications laser. These results are close to the ones obtained with analytical models for a similar system [3], [8], and [9].

However, if compared to measurement, at high level (above 20 dBm) and in the particular case of the LM modulation, some differences appeared between simulation and experiment. These differences may be due to thermal or charge effects at high power in the modulator, which are not described in the model. This discrepancy is still under study,

but it occurs in an RF power range which is above the one which is effectively foreseen in our application.

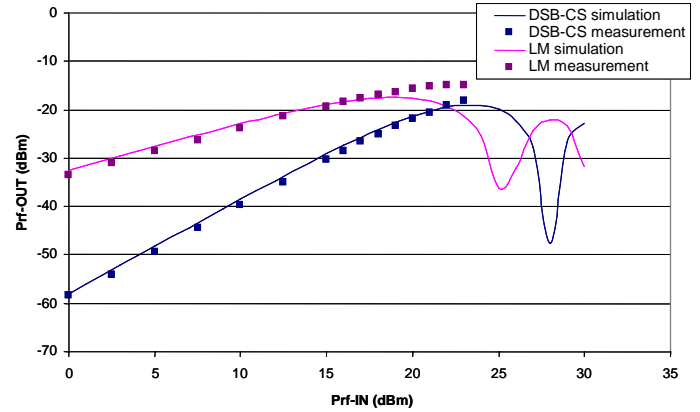

Fig. 3 RF output power versus RF input power of the optical link simulated and measured (10 GHz output frequency)

III. MZ MODULATOR BASED OPTICAL LINK MODEL: RF NOISE AND PHASE NOISE.

One of the systems we would like to simulate with this approach is the optical electric oscillator (OEO), and particularly its phase noise performance. This is quite difficult because it is an autonomous system, in which the oscillation start up has to be managed independently from the optical signal. However, the performance of the OEO can be computed from its open loop phase noise, and we have started these investigations by studying phase noise in open loop RF optical links and systems.

Figure 4 represents the various carriers (either microwave or optical) which are interacting in our systems, and their noise sidebands. These noise sidebands are correlated through the system nonlinear elements, and the choice of ADS for these investigations has been based mainly on the ability of this software to take into account these correlations thanks to a conversion matrices approach in harmonic balance [2]. The optical carrier is considered in our simulations just like any other carrier, and is described with its noise components: AM noise and FM noise.

The laser model is composed of a frequency source with an associated phase noise spectrum followed by an AM noise modulator. The two noise components are extracted from the measurement.

The laser frequency noise is estimated from the laser linewidth measurement, which is performed using a self-heterodyne measurement bench. At this time, we have made the classical hypothesis of a constant (white) frequency noise for the laser, equal to the laser linewidth divided by π . In a second step, a laser frequency noise measurement set up will allow us to extract the $1/f$ frequency noise of the laser, which will be included in the model.

The laser relative amplitude noise (RIN) is measured on a dedicated measurement bench, which includes two different set-up: one for the measurement of the laser $1/f$ RIN, between DC and 100 kHz [4,10], and another one for the measurement of the laser microwave RIN, which uses a fast photodiode and a low noise microwave amplifier up to approximately 15 GHz.

These data have been used in the noise source associated to the AM modulator of the laser model.

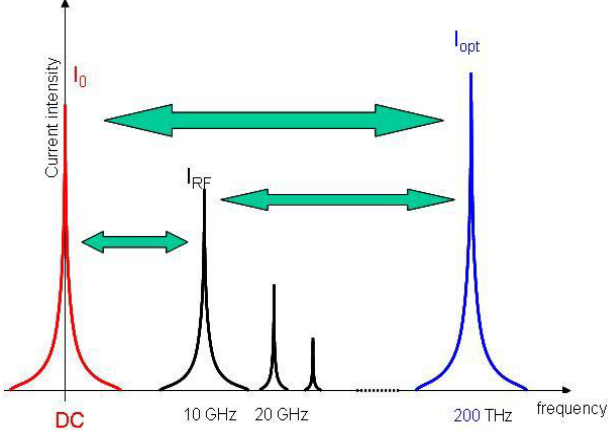

Fig. 4 Schematics of the noise conversion processes between the different carrier and their harmonics: DC, RF and optical

Concerning the photodiode, its noise model includes the Schottky white noise, the thermal noise and a $1/f$ noise component which is difficult to measure but which can be estimated from dual diode receiver measurements. The diode model also includes a nonlinear capacitance, which will be further described.

At this time, the MZ modulator is considered as a non-noisy (but nonlinear) device.

Figure 5 represents the result of the simulation of the noise component around the DC for the complete MZ based optical link. The simulated noise is divided by the DC carrier, in order to compare it to the laser RIN. One of the interests of this simulation is in determining the phase noise floor, which is related to the carrier to noise ratio at the RF modulation frequency.

Figure 6 depicts the phase noise and amplitude noise simulations around the RF carrier at 10 GHz, obtained with the “pnmx” and “anmx” outputs of ADS software.

Contrary to the result presented in Figure 5, no $1/f$ phase noise has been computed. Only a $1/f$ AM noise is visible around the 10 GHz RF carrier. The computed phase noise is thus restricted to the noise/signal ratio, which can be computed from the RIN value and the RF output power at 10 GHz.

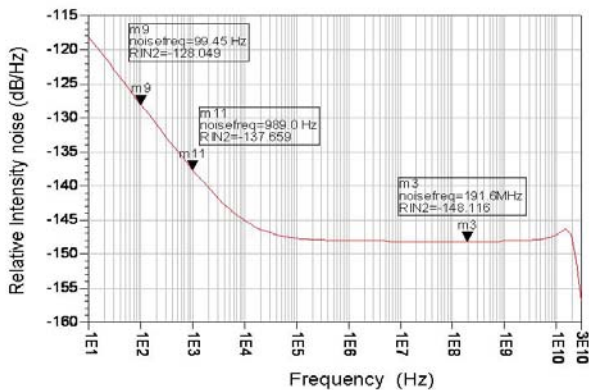

Fig. 5 ADS simulation of the noise to DC carrier ratio at the output of the optical link

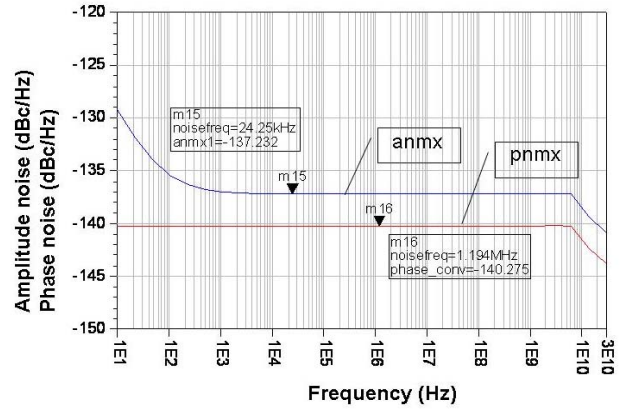

Fig. 6 Simulated optical link phase noise and amplitude noise around the RF carrier (10 GHz)

The absence of $1/f$ phase noise was unexpected, as $1/f$ phase noise had previously been measured in such links [3,6,7]. This noise component is relatively weak (typically weaker than the $1/f$ phase noise of a microwave amplifier), but it is not negligible. One possible explanation is that we have not included in the model all the $1/f$ noise sources of the physical system, or not all the nonlinearities. At first, the model included only the laser’s $1/f$ amplitude noise and the nonlinearity of the MZ modulator. This results in a relatively high level of $1/f$ amplitude noise around the DC output (this is normal, because the optical link is based on amplitude detection), but no $1/f$ phase noise around the RF carrier was computed. We have then added a noise component associated to the photodiode. Direct conversion of low frequency noise into phase noise in this component is possible, but such a process requires a reactive element in the photodiode model to generate the phase modulation by the baseband $1/f$ noise. Such a conversion could be performed by the diode nonlinear capacitance.

Following published models of photodiodes [5], as well as our own measurements of the biased and illuminated photodiode using an impedance meter [10], we have added to our model this nonlinear capacitance. The problem is that the diode’s capacitance is almost constant in the working zone to be used in photodetection (a reverse bias of -6 V). This explains why adding this nonlinearity to the model, together with a $1/f$ noise source, has not induced any visible $1/f$ phase noise contribution on the RF output. This problem is still under study at this time. However, we think that the $1/f$ phase noise contribution has little chance to be generated by the photodiode, or at least that the phenomenon will not be described by a classical photodiode electrical model.

IV. EXAMPLE OF SYSTEM SIMULATION: THE OPTICAL DELAY LINE MICROWAVE FREQUENCY DISCRIMINATOR.

Up to now, the most complex system we have been able to simulate with our CAD approach is a microwave phase noise measurement bench based on a 4 km optical delay line. This system has been realized in our laboratory and is described in another paper [3].

The measurement of the phase noise floor of a delay line discriminator is quite difficult. The classical approach suppresses the delay line, in order to cancel the sensitivity of the system to the source phase noise. This technique is valid for classical microwave frequency discriminators. However, in case of microwave-optical frequency discriminator, some noise processes may occur in the optical delay line itself, and it is thus important to characterize the system including this line.

The only technique in this case is to use an ultra high spectral purity source, such as a sapphire microwave oscillator, to check the ability of the microwave-optical measurement bench to characterize ultra low phase noise sources. Such an oscillator at 4.86 GHz is available in our laboratory. It had been realized with a low phase noise SiGe amplifier and a WGM sapphire resonator ($Q_L \approx 60,000$) [11].

The phase noise of this oscillator has been measured close to the carrier using an Agilent E5052 phase noise measurement bench. Then the oscillator has been connected to the microwave optical frequency discriminator and the result is plotted in Fig. 8. As shown, the sapphire oscillator is effectively measured by the discriminator and on a wider range of baseband frequencies, although the first spurious peak of the 4 km delay line is clearly visible on this plot around 53 kHz, and prevents the phase noise measurement in its vicinity.

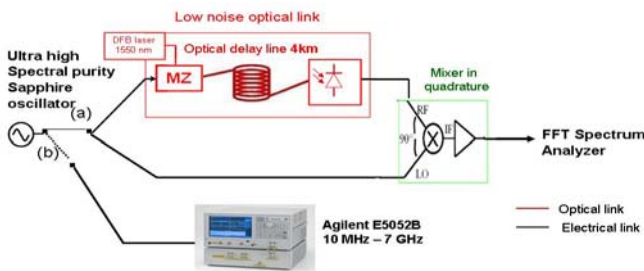

Fig. 7 (a) Scheme of the optical link phase noise measurement bench using the sapphire and (b) Agilent phase noise measurement bench used to evaluate the phase noise of the sapphire oscillator.

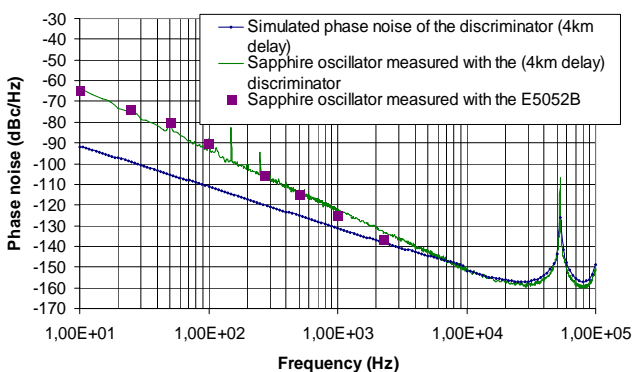

Fig. 8 Simulated and measured phase noise of the optical-microwave delay line frequency discriminator (4 km delay line)

The phase noise floor of this system has also been simulated with the approach described in sections I, II and III. The simulated general behaviour is correct, including the noise peaks due to the drop in sensitivity near 53 kHz and its harmonics. Close to the carrier, the simulated phase noise is quite optimistic due to the absence of $1/f$ noise.

However, this validates our approach on a complex system, which would be very difficult to model with a classical analytical approach.

V. CONCLUSION

Our modelling approach is able to describe the main parameters of a microwave optical link, such as the power gain or the signal to noise ratio. The simulation of the optical link additive phase noise has also been performed, but the result obtained can only be related at this time to the signal to noise ratio. No significant $1/f$ phase noise has been simulated, and the $1/f$ component of the spectra around the RF carrier is either related to the amplitude noise. Further investigations are in progress, particularly to use this approach in different systems such as microwave optical oscillators.

REFERENCES

- [1] X.S. Yao, L. Maleki, D. Eliyahu, "Progress in the optoelectronic oscillator – a ten year anniversary review", 2004 IEEE Microwave Theory and Tech. Symp. Digest, pp. 287-90.
- [2] V. Rizzoli, et al., "General noise analysis of nonlinear microwave circuits by the piecewise harmonic-balance technique", IEEE trans. on MTT, 42(5), pp. 807-19, 1994.
- [3] B. Onillon, S. Constant, O. Llopis, "Optical links for ultra-low phase noise microwave oscillators measurement", Proc. of the IEEE Int. Freq. Control Symposium, Vancouver, 2005, pp. 545-50.
- [4] B. Onillon, S. Constant, G. Quadri, B. Benazet, O. Llopis, "Optical-microwave links for LO distribution in space systems", Proc. of the EuMA, 1(3), special issue on microwave for space, 2005, pp. 206-11.
- [5] J. Dawidczyk, et al., "Investigation of Optical-Microwave Frequency Conversion Processes for PIN Photodiode", 1999, Proc. of EDMO 1999 Symposium, King's College London, p.103-07.
- [6] E. Rubiola, et al. "Flicker noise in high-speed p-i-n photodiodes", Microwave Theory and Techniques, IEEE Transactions on 54(2), Part 2, Feb. 2006, pp.816–20.
- [7] M.-B. Bibey, et al. "Very low phase-noise optical links-experiments and theory", Microwave Theory and Techniques, IEEE Transactions on 47(12), Dec. 1999 pp.2257-62.
- [8] Y. Le Guennec, et al. "Performance of interferometric systems for optical processing of microwave signals: influence of laser- and microwave-phase noises", Photonics Technology Letters, IEEE 16(9), Sept. 2004 pp. 2120-22.
- [9] A. Hilt, "Microwave harmonic generation in fiber-optical links", Microwaves, Radar and Wireless Communications. 2000. MIKON-2000. 13th International Conference on Volume 2, 22-24 May 2000 pp. 693-98 vol.2.
- [10] H. Brahimi, P.H. Merrer, O. Llopis, "CAD of microwave optical systems for time&frequency applications" Proc. of the European Frequency and Time and Forum (EFTF), Toulouse, April 2008.
- [11] G. Cibiel et al., "Optimization of an ultra low phase noise Sapphire SiGe - HBT oscillator using nonlinear CAD", IEEE Transactions on Ultrasonics, Ferroelectrics and Frequency control, vol 51, n° 1, Janvier 2004, pp. 33-41