



**HAL**  
open science

# Robust Strategy for Intake Leakage Detection in Diesel Engines

Riccardo Ceccarelli, Philippe Moulin, Carlos Canudas de Wit

► **To cite this version:**

Riccardo Ceccarelli, Philippe Moulin, Carlos Canudas de Wit. Robust Strategy for Intake Leakage Detection in Diesel Engines. MSC 2009 - CCA 2009 - 3rd IEEE Multi-conference on Systems and Control - 18th IEEE International Conference on Control Applications, Jul 2009, Saint Petersburg, Russia. pp.s/n. hal-00394983

**HAL Id: hal-00394983**

**<https://hal.science/hal-00394983>**

Submitted on 13 Jun 2009

**HAL** is a multi-disciplinary open access archive for the deposit and dissemination of scientific research documents, whether they are published or not. The documents may come from teaching and research institutions in France or abroad, or from public or private research centers.

L'archive ouverte pluridisciplinaire **HAL**, est destinée au dépôt et à la diffusion de documents scientifiques de niveau recherche, publiés ou non, émanant des établissements d'enseignement et de recherche français ou étrangers, des laboratoires publics ou privés.

# Robust Strategy for Intake Leakage Detection in Diesel Engines

Riccardo Ceccarelli , Philippe Moulin, Carlos Canudas-de-Wit

**Abstract**—Fault detection is motivated by the needs of guaranteeing high-performance engine behavior and regarding to the environmentally-based legislative regulations. An adaptive model-based observer strategy is applied for the fault detection and estimation. The hole estimation relies on the model accuracy and sensors precision. In this paper is provided by a model-based upper bound for leakage error estimation for threshold design by the mean of the observer sensitivity study. The proposed approach generates a threshold based only on the available measures even if faulty. Simulation results are provided using advanced Diesel engine developed under AMESim.

## I. INTRODUCTION

The modern Diesel engine has the potential of a significant reduction of pollutant emissions with respect to more conventional engines. The proper system operation is strongly dependent on the correct functioning of all these subsystems. In order to hold by environmentally-based legislative regulations and for safety reasons, monitoring tasks such as leakages at different locations, the detection of malfunctioning of sensors and actuators (i.e. EGR valve opening) are necessary.

A promising way to enhance monitoring and diagnosis systems is to adopt model-based techniques, which have been used in different engine frameworks [12], [10], [11] [7], [8]. See also [9] for a survey. Physical models of intake receiver can be found in [13] where a deep description and analysis of the functioning of a air-path in a Diesel engine with exhaust gas recirculation circuit is presented. More physical air-path modeling, including mass and energy conservation laws applied to the receiver, flows modeling can be found in [5],[6].

Model-based adaptive observers represent a good strategy for intake leakage detection and estimation. Adaptive observers allow not only to estimate signals that are not available from direct measurement, but also some of the unknown model parameters. In some cases, as here, the unknown model parameters are directly associated to the fault to be detected, and the observer can also track small variations of such parameters.

In all model-based approach, the sensitivity of estimation parameter relies on the accuracy of model used in the observer and on measurements's errors.

R. Ceccarelli (corresponding author) is a PhD Candidate in Automatic Control at GIPSA-lab, Institut National Polytechnique de Grenoble, 961, rue de la Houille Blanche Domaine universitaire - BP 46 F - 38402 Saint Martin d'Hères, France [riccardo.ceccarelli@ifp.fr](mailto:riccardo.ceccarelli@ifp.fr)

P. Moulin is with the Department of Engine Control in IFP, 1 et 4 Avenue de Bois Preau, 92852 Rueil-Malmaison, France

C. Canudas-de-Wit is with the CNRS at the Control System Department of GIPSA-lab [carlos.canudas-de-wit@inpg.fr](mailto:carlos.canudas-de-wit@inpg.fr)

In this paper a nonlinear adaptive observer designed on Lyapunov functions as proposed in [1] is used for hole detection and estimation. For other application of this type of observers refer to [2], [3], [4].

The main contribution of this paper is to study, in steady-state case, an upper bound for the modeling and the sensors' errors with respect to leakage estimation error. By the mean of these upper bounds a variable model-based threshold is designed. In particular a bound on error due to exhaust pressure sensor bias used in EGR mass flow equation and for two different modeled additive bounded bias on air mass flow and engine volumetric efficiency look-up table are provided.

The paper is organized as follows. A reference model is presented in Section II. Section III presents the observer used for leakage estimation. Persistent condition for parameter estimation is discussed with respect to leakage hole diameter estimation. Section IV is dedicated to the design of a variable threshold by the sensitivity analysis of the observer with respect to possible modeling or measurement errors. Threshold determination for fault detection is investigated and some simulation results for 4 mm hole diameter are provided in section V.

## II. SYSTEM DESCRIPTION

The Diesel engine considered in this paper is a four-cylinders engine with a high-pressure exhaust gas recirculation circuit (EGR) as described in [13]. This section introduces a simpler representation of the engine when an intake leakage is present. The obtained model will be use to design an observer. A description of engine and justification of some simplification is done in [14]. A schematic picture of the air intake system is shown in Figure 1.

Ambient air enters in the intake receiver through the compressor and its flow rate  $D_{air}$  is measured by a mass air flow sensor. Fresh air is mixed in the intake receiver with exhaust gas coming from the exhaust receiver ( $D_{egr}$ ) and then aspirated ( $D_{asp}$ ) by the engine that is seen as a volumetric pump. The intake volume is assumed as small enough to approximate the process as isothermal. Under previous assumption, the intake pressure  $p_{int}$  is the only state variable, whose dynamics is

$$\dot{p}_{int} = \alpha_{int} (D_{air} + D_{egr} - D_{asp} - D_{Leak}), \quad (1)$$

where  $\alpha_{int} \triangleq R_{air}T_{int}/V_{int}$ ,  $R_{air}$  is the universal gas constant,  $V_{int}$  is the intake volume,  $T_{int}$  is the measured intake temperature,  $D_{Leak}$  is the leakage mass flow rate from the intake in presence of a hole. All flows are modeled by the

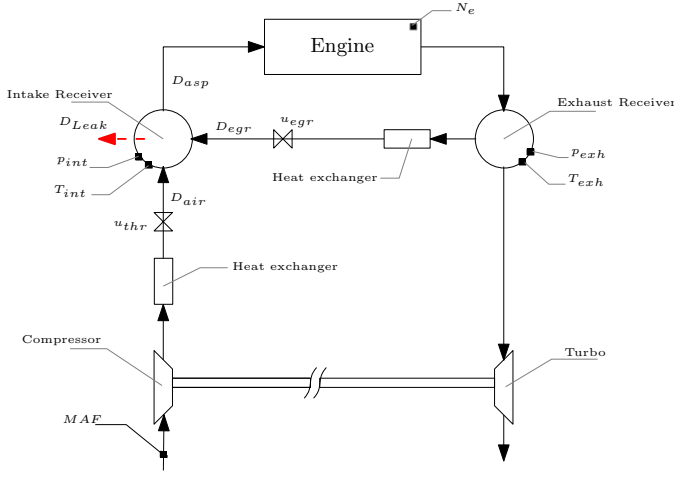

Fig. 1. A schematic picture of the air-intake system.

following generic equation of flow through an orifice [6],

$$D = S \frac{p_{in}}{\sqrt{RT_{in}}} \sigma \left( \frac{p_{out}}{p_{in}} \right) \quad (2)$$

where

$$\sigma \left( \frac{p_{out}}{p_{in}} \right) = \begin{cases} \frac{1}{\sqrt{2}} & \text{if } \frac{1}{2}p_{in} \geq p_{out} \\ \sqrt{2 \frac{p_{out}}{p_{in}} \left( 1 - \frac{p_{out}}{p_{in}} \right)} & \text{if } \frac{1}{2}p_{in} \leq p_{out} \end{cases}$$

and where the subscripts “in” and “out” stand for upstream and downstream values across a (possibly variable-area) section  $S$ .

Equation (1) can be re-written as a first general structure

$$\begin{cases} \dot{x} = -a(x, z)x - \psi(x, z)\theta + \phi(x, z) \\ \dot{\theta} = 0 \\ y = x \end{cases} \quad (3)$$

where the scalar state  $x(t) = p_{int}$ ,  $z \in \mathbb{R}^8$  is a vector containing measured variables (see TABLE I for details) and  $y$  stands for the measured output. Finally,  $\theta$  is the parameter to be estimated, that is, the percentage of the maximal leakage (5) such that  $D_{Leak} = \theta \cdot \psi(x, z)$ . In the following  $y(t)$  and  $x(t)$  will be used without distinction. Moreover

$$a(x, z) = \alpha_{int} \beta_{int} \eta_v(x, N_e) \quad (4)$$

$$\psi(x, z) = \alpha_{int} S_{max} \frac{x}{\sqrt{RT_{in}}} \sigma \left( \frac{p_{amb}}{x} \right) \quad (5)$$

$$\phi(x, z) = \alpha_{int} (D_{air} + D_{egr}) \quad (6)$$

where  $\psi(x, z)$  is the gas mass flow rate through the hole when  $S = S_{max}$ ,  $a(x, z)x$  is the flow  $D_{asp}$  aspirated by the engine is considered as a volumetric pump,  $\eta_v(x, N_e)$  is the engine volumetric efficiency, generally tabulated as a function of intake pressure and engine speed, and

$$\beta_{int} \triangleq \frac{1}{RT_{int}} V_{cyl} \frac{N_e}{120}$$

where  $V_{cyl}$  is the total displacement volume.

The EGR flow  $D_{egr}$  is computed by using the available measures of  $p_{exh}$ ,  $T_{exh}$ ,  $p_{int}$ ,  $u_{egr}$  in equation (2). By injecting the measured state  $y(t)$  in  $a$ ,  $\psi$  and  $\phi$ , equation (3) can be re-written as

$$\begin{cases} \dot{x} = -a(t)x - \psi(t)\theta + \phi(t) \\ \dot{\theta} = 0 \\ y = x \end{cases} \quad (7)$$

where  $a$ ,  $\psi$  and  $\phi$  are now completely known functions. Note that the original system model (1) has been extended with the additional equation  $\dot{\theta} = 0$ , which implicitly assumes that this parameter is constant. It is also straightforward to note that  $\theta$  is observable from  $y$  as long as  $\psi(t) \neq 0$ . Hence observability of  $\theta$  is preserved even if  $\psi(t) = 0$  only at a finite numbers of points in time.

TABLE I  
EXTERNAL VARIABLES

Variable name	Meas. name	Description	Units
$z_1$	$D_{air}$	Mass air flow	[kg/s]
$z_2$	$T_{int}$	Intake temperature	[K]
$z_3$	$p_{exh}$	Exhaust pressure	[Pa]
$z_4$	$T_{exh}$	Exhaust temperature	[K]
$z_5$	$u_{egr}$	Egr valve position	[%]
$z_6$	$u_{thr}$	Throttle valve position	[%]
$z_7$	$N_e$	Engine speed	[rad/s]
$z_8$	$p_{amb}$	Ambient pressure	[Pa]

### III. ADAPTIVE OBSERVER

In this section a nonlinear adaptive observer used for intake leakage detection is presented and, by the means of some simulations, threshold specifications are deduced.

The nonlinear adaptive observer used for fault detection is designed based on Lyapounov function [1] and it has the following structure

$$\begin{cases} \dot{\hat{x}} = -a(t)\hat{x} - \psi(t)\hat{\theta} + \phi(t) + K_0(y - \hat{x}) \\ \dot{\hat{\theta}} = -\gamma\psi(t)(y - \hat{x}) \end{cases} \quad (8)$$

where  $y$  is the intake measured pressure,  $\hat{x}$  is its estimation,  $\gamma$  and  $K_0$  are two positive constant tuning gains for the stability and convergence rate.

Further in the article  $\tilde{x} = y - \hat{x}$  is used and stands for the estimation error of the observer.

Lyapounov analysis is used to prove that the observer (8) converges to a correct estimation of the intake pressure, i.e.  $\tilde{x} = 0$ , and to the correct hole estimation if the observability condition

$$\psi(t) \neq 0 \quad (9)$$

is respected. When there is not leakage through the intake receiver, in ideal condition, the estimate parameter  $\hat{\theta}$  is equal to zero and equal to the diameter of the hole when leakage appears. In practice, as measurements are affected by some bias and there are some modeling errors, i.e. flow through valve equation (2), the estimation of the parameter  $\hat{\theta}$  converges to some value different from the real measure of the hole.

Morover, if the observability condition (9) is not or is weakly respected (i.e.  $\psi(t) \approx 0$ ), the convergence of  $\hat{\theta}$  is not guaranteed to the good value or the convergence speed rate could be very long compared to the dynamics.

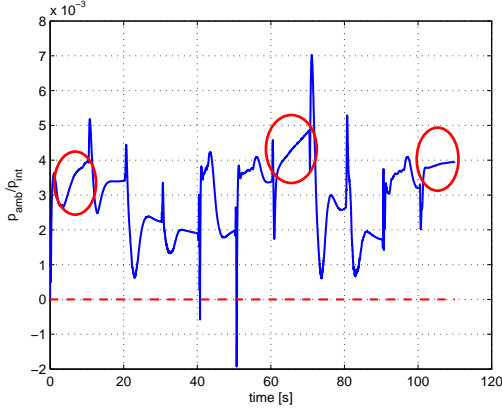

Fig. 2. No leakage - (solid line)  $\hat{\theta}$  estimated by the observer along the load transient trajectory. Reference hole diameter (dashed line). Circles show the convergence of the parameter when there is a weak observability condition.

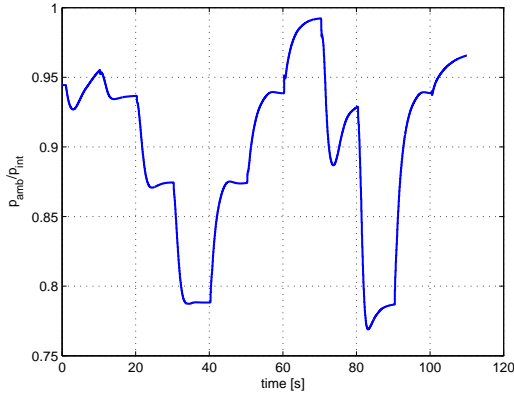

Fig. 3. No leakage - Pressure ratio  $p_{amb}/p_{int}$  during the load transient.

As an example of the problems exposed above, Figure 2 shows the estimation of  $\hat{\theta}(t)$  by the adaptive observer during a transient load equal to  $[4\ 5\ 6\ 7\ 6\ 5\ 2\ 5\ 7\ 5\ 4]$  bar, at  $1500\ rpm$  when there is no leakage in intake receiver. In Figure (3) is shown the pressure ratio  $p_{amb}/p_{int}$  which rely to the observability condition, i.e., when the ratio is close to the unit then the equation (5) go to zero. In intervals where the condition (9) is not or is weakly verified, the hole estimation's speed convergence reduce or, in worst case, is equal to zero. The phenomenon is shown in Figure 2 by circled intervals.

In Figure 4, is shown how the observer estimates a  $4mm$  hole.

In [1] a very simple fixed threshold was proposed, equal to the maximum estimation of the hole diameter when no leakage was present. With respect to Figure 2 the threshold would be chosen equal to  $6mm$ . By this choice the leakage estimated in Figure 4 would not be detected.

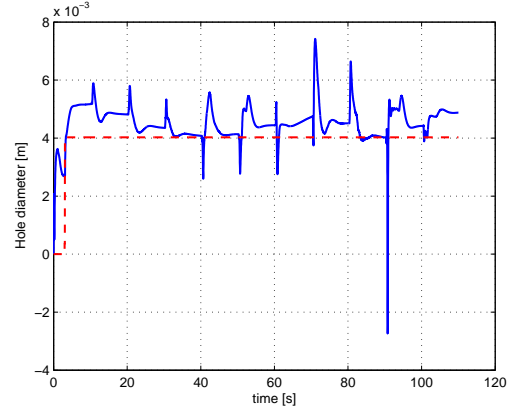

Fig. 4.  $4mm$  leakage - (solid)  $\hat{\theta}$  estimated by the observer along the load transient trajectory. Reference hole diameter (dashed).

All this consideration lead to the design of a variable threshold with the following specifications:

- signals driven threshold even if available measures are faulty;
- the threshold is model-based.

#### IV. VARIABLE THRESHOLD

In this section, first it will be shown how the observability condition and possible errors can be taken into account during the design of the variable threshold then, an upper bound for two classes of modeling errors: sensors measurement bias and the use of a faulty measure for estimate a mass flow by the equation (2).

##### A. Observer Sensitivity Analysis

Consider a general observer with the same structure as (8)

$$\begin{cases} \dot{\hat{x}} &= f(\hat{x}, z, y) + \psi(z, y)\hat{\theta} + \phi(z, y) + K_0\tilde{x} \\ \dot{\hat{\theta}} &= g(z, y)\tilde{x} \end{cases} \quad (10)$$

where, for analogy,  $f(\hat{x}, z, y) = a(t)\hat{x}$  and  $g(z, y) = -\gamma\psi(t)$ . As (7) is a stable system, the observer can be studied in stationary conditions. By this hypothesis (10) becomes

$$0 = f(\hat{x}, z, y) + \psi(z, y)\hat{\theta} + \phi(z, y) \quad (11)$$

where  $\hat{\theta}$ , in ideal case, is equal to

$$\hat{\theta} = -\frac{1}{\psi(z, y)}[f(\hat{x}, z, y) + \phi(z, y)] \quad (12)$$

As already discussed, the  $\psi(z, y)$  term acts on convergence speed rate of the parameter. If  $\psi(z, y) \neq 0$ , it acts on final value of estimated parameter.

The result (12) is obtained if a perfect matching model of the system is used. In real case, equation (11) writes

$$\begin{aligned} 0 &= f(\hat{x}, z^*, y^*) + \Delta f(\hat{x}, z^*, y^*) \\ &+ \psi(z^*, y^*)\hat{\theta} + \phi(z^*, y^*) \\ &+ \phi(z^* + \Delta z, y^*) \end{aligned} \quad (13)$$

where the symbol  $*$  stands for the correct value of a measure or parameter and  $\hat{\theta} = \theta^* + \Delta\theta$ . The symbol  $\Delta$  has to be considered as a small perturbation with respect to the correct function it refers to. In details the equation (13) shows different error types:

- $\Delta f(\hat{x}, z^*, y^*)$  stands for modeling error terms;
- $\phi(z^* + \Delta z, y^*)$  stands for terms correctly modeled but evaluated with a measure affected by errors;
- $\Delta\theta$  stands for the parameter estimation error;

The  $\Delta\theta$  term represents the error made by the estimation, due to modeling and measurement errors. By (12) and neglecting the second order term, equation (13) becomes

$$\Delta\theta = -\frac{1}{\psi(z^*, y^*)} [\Delta f(\hat{x}, z^*, y^*) + \phi(z^* + \Delta z, y^*)] \quad (14)$$

which points out the effect of every error terms on the correct estimation of the hole's diameter. The idea, for the threshold design, is to find an upper bound to each error term of equation (14).

### B. Error Models

With respect to the intake leakage detection problem, two different types of error are considered.

1) *First error type*: Consider  $\xi \in \mathbb{R}$ , the first class of considered errors is

$$\xi = \xi^* + \Delta\xi \quad (15)$$

An upper bound for  $\Delta\xi$  is the object of the two following propositions.

*Proposition 1*: Consider a scalar bounded variable  $\epsilon(t)$  such that  $|\epsilon(t)| \leq M_\epsilon$  with  $M_\epsilon > 0$  then, if

$$\Delta\xi = \epsilon(t) \quad (16)$$

then

$$|\Delta\xi| \leq M_\epsilon \quad (17)$$

*Proposition 2*: Consider a scalar bounded variable  $\alpha(t)$  such that  $|\alpha(t)| \leq M_\alpha$  with  $M_\alpha > 0$ . If

$$|\alpha(t)| \leq M_\alpha \ll 1 \quad (18)$$

and

$$\Delta\xi = \alpha(t) \cdot \xi^* \quad (19)$$

then

$$|\Delta\xi| \leq M_\alpha \xi \quad (20)$$

*Proof*: From (15) and (19) holds

$$\xi^* = \frac{1}{1 + \alpha} \xi \quad (21)$$

then, by (18), it comes

$$\Delta\xi = \frac{\alpha}{1 + \alpha} \xi \leq \frac{M_\alpha}{1 + \alpha} \xi \leq M_\alpha \xi \quad (22)$$

2) *Second error type*: Consider a scalar function  $h : D \rightarrow \mathbb{R}$  and  $\xi \in \mathbb{R}$  as defined in (15), the error considered here are of the type

$$h(\xi) = h(\xi^*) + \Delta h(\xi) \quad (23)$$

where a function is evaluated by using a biased variable. The aim of the following proposition is to find an upper bound to  $|\Delta h(\xi)|$ .

*Proposition 3*: Consider a scalar function  $h : D \rightarrow \mathbb{R}$  satisfying

$$\begin{aligned} h(\xi) &\geq 0 \\ h'(\xi) &> 0 \\ h''(\xi) &< 0 \end{aligned} \quad (24)$$

and  $\xi = \xi^* + \epsilon(t)$  with  $|\epsilon(t)| \leq M_\epsilon$ , then an upper bound for the estimation error is

$$|\Delta h(\xi)| \leq |h'(\xi - M_\epsilon)| M_\epsilon \quad (25)$$

*Proof*: From (15), (24), the following inequality holds

$$\Delta h(\xi) \leq h'(\xi^*) \Delta\xi \quad (26)$$

by the means of the hypothesis on  $h'(\xi) > 0$ , it is possible to write the previous inequality with modules as

$$|\Delta h(\xi)| \leq |h'(\xi^*)| M_\epsilon \quad (27)$$

This last inequality is always true if  $\xi^*$  is known in order to evaluate the function first derivative. The only available measure is  $\xi = \xi^* + \epsilon(t)$ , so an estimation of an upper bound of  $h'(\xi^*)$  is provided.

It is true that  $\forall \xi \in D, \xi - M_\epsilon \leq \xi^*$ . As  $|h'(\xi^*)|$  is a positive decreasing function, it follows

$$|h'(\xi - M_\epsilon)| \geq |h'(\xi^*)| \quad (28)$$

This lead to prove that

$$|\Delta h(\xi)| \leq |h'(\xi - M_\epsilon)| M_\epsilon \quad (29)$$

■

### C. Variable threshold design

The variable threshold is designed in order to be an upper bound to the  $|\Delta\theta|$  appearing in (14).

For the particular application, i.e., intake leakage detection, model errors have been related to the first type of error (16). For example, the  $\Delta f(\hat{x}, z^*, y^*)$ , which represents the engine aspirated gas, is modeled as a constant bounded error, i.e.,  $\Delta f(\hat{x}, z^*, y^*) = \epsilon_{asp}(t)$ , where  $\|\Delta f(\hat{x}, z^*, y^*)\|_\infty = M_{asp}$ . Terms like  $\phi(z^* + \Delta z, y^*)$  can be modeled by (23). With respect to studied system, such kind of term models error due to the evaluation of EGR flow using (2) when the variable  $z_3$  (Table II) is affected by a bounded additive error,  $\epsilon_{exh}$ , of the type discussed in Proposition 1 .

For the air mass flow sensor (MAF) it was modeled as an error of the first type with a multiplicative bias, as explained in Proposition 2, where the positive constant  $M_{air}$  is choosed as the max tolerance provided by the manufacturer .

■



In conclusion the proposed threshold is

$$\theta_{th} = \frac{1}{\psi(z^*, y^*)} \left( M_{asp} + M_{air} z_1 + \left| \frac{\partial}{\partial z_3} D_{egr} \right| M_{exh} \right) \quad (30)$$

## V. SIMULATION RESULTS

This section is devoted to the intake leakage detection by the use of the adaptive observer (8) and by a variable threshold as presented in equation (30).

### A. Experimental description and diagnosis

All simulations have been done on a four cylinder Diesel engine model running on AMESim platform in cosimulation with Mathwork Matlab. The AMESim model used for simulation has been validated on engine testbed, [13]. Simulation conditions are the following:

- $N_e = 1500$  rpm;
- IMEP trajectory = [4 5 6 7 6 5 2 5 7 5 4] bar;
- IMEP step time = 10 s;
- Air mass flow sensor is modeled with a proportional to signal bounded bias  $\alpha_{air}$ , with  $M_{air} = 0.03$ ;
- Engine aspire flow,  $D_{asp}$  is modeled with a proportional to signal bounded bias  $\alpha_{asp}$ , with  $M_{asp} = 0.04$ ;
- Exhaust pressure bias is modeled as additive bounded error  $\epsilon_{exh}(t)$ , with  $M_{exh} = 200$  mbar ;

The above conditions lead to build the threshold (30) as follow

$$\theta_{th} = \frac{1}{\psi(z_8, y)} \left( 0.04 + 0.03 \cdot z_1 + 200 \cdot 10^2 \left| \frac{\partial}{\partial z_3} D_{EGR} \right| \right)$$

where

$$\left| \frac{\partial}{\partial z_3} D_{EGR} \right| = \left| \frac{\sqrt{2}}{2\sqrt{Rz_4}} \frac{\sqrt{y}}{\sqrt{z_3 - 200 \cdot 10^2 - y}} \right|$$

is the explicit upper bound for EGR mass flow evaluated with an exhaust biased pressure sensors.

### B. AMESim-MATLAB simulation

The first set of simulations are about hole estimation when no leakage is present but a bias is present in air mass flow sensor. In Figure 5 is shown the estimation along the load trajectory when  $\alpha_{air} = 0.03$ . The bottom part of the Figure 5 shows the pressure ratio and, when a weak observability condition is reached, the threshold is more conservative. In Figure 6 shows the estimation of a 4mm hole when a positive bias is present on the air mass flow sensor. Simulations in which two different biases are applied to the exhaust pressure sensor, when there is not hole in the intake manifold, are shown in Figure 7. In particular, Figure 7a shows when the threshold is generated by a  $M_{exh} = 200$  mbar and no bias is present in sensor measurement; Figure 7b points out how the hole estimation, when the sensor is affected by a bias equal to  $M_{exh}$ , it is close to the proposed threshold. Figure 8 shows how, when a 4mm hole is present on the intake receiver and  $\epsilon_{exh} = 200$  mbar. As expected the identification of the hole is almost false due to the bias, but the detection of the hole is still possible because the estimated signal is greater than

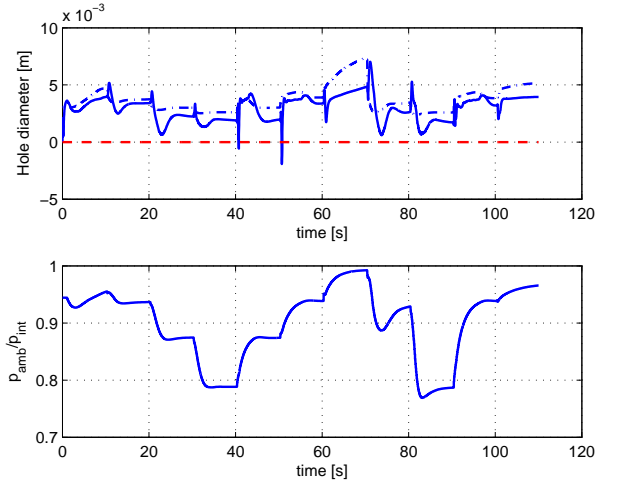

Fig. 5. No Hole - (top figure) hole estimation in solid line, variable threshold (dot dashed) and hole reference diameter (dashed) when  $\alpha_{air} = 0.03$ . (Bottom figure) is shown the pressure ratio  $p_{amb}/p_{int}$ .

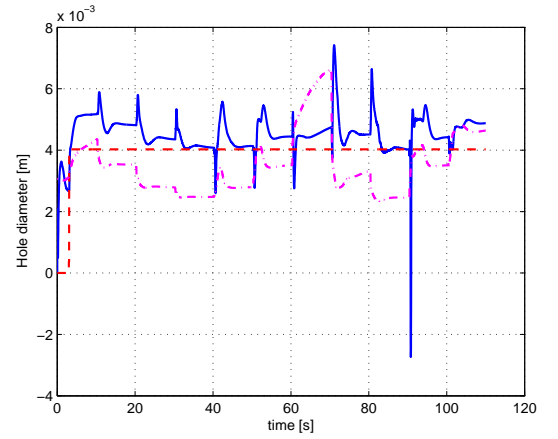

Fig. 6. 4mm Hole - Hole estimation in solid line and variable threshold is dot dashed when  $\alpha_{air} = 0.03$ . Reference hole diameter is dashed.

the threshold signal. In Figure 9 is possible to see that if the threshold is generated with a  $M_{air} = 200$  mbar is no more possible to detect the 4mm hole. This lead to conclude that smaller is the bias  $\epsilon_{exh}$  with respect to  $M_{exh}$ , greater should be the hole diameter in order to be detected.

## VI. CONCLUSION

In this paper, a nonlinear adaptive observer is used for intake leakage detection and a variable model-based threshold based on available measurements is presented. In particular the proposed threshold is designed to take into account the leakage observability and possible bias on sensors measurements. Two class of error are considered and an explicit upper bound based only on available measurements is provided. The main drawback of the proposed strategy is that, as the threshold is equal to the sum, for each error considered, of its upper

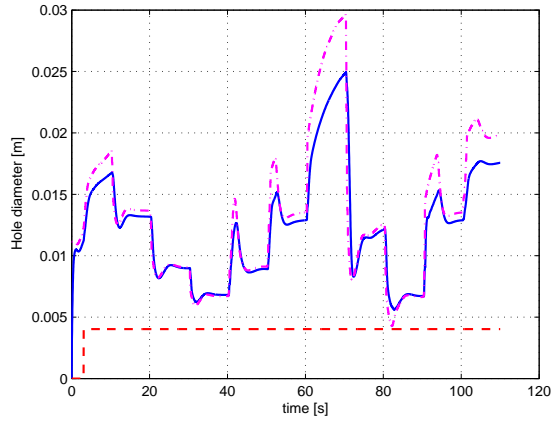

Fig. 9. 4mm Hole - Hole estimation in solid line and variable thresholds are dot dashed when  $\epsilon_{exh} = 150\text{mbar}$  and  $M_{exh} = 200\text{mbar}$ . Reference hole diameter is dashed.

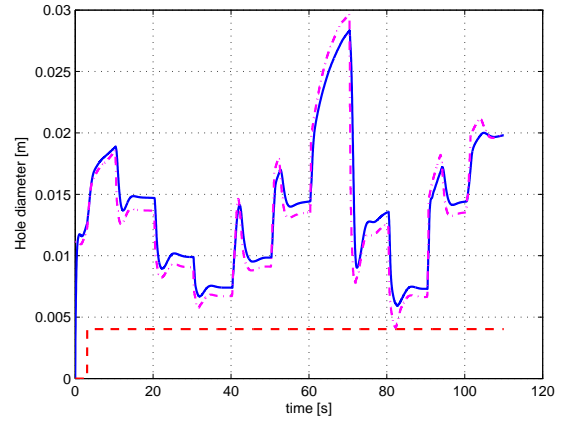
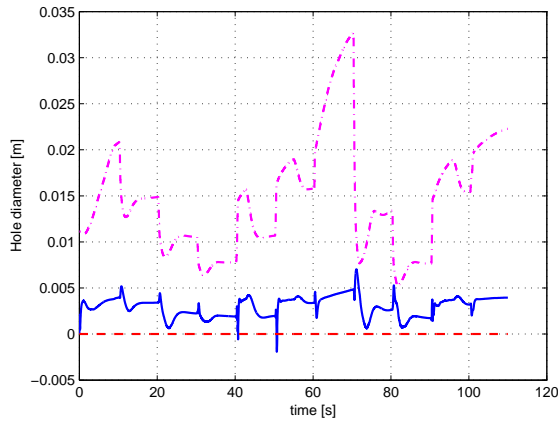
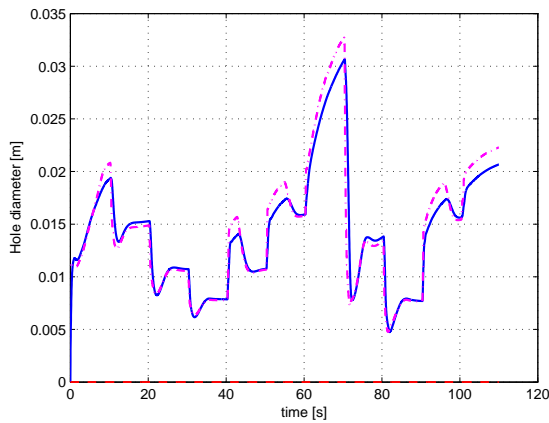

Fig. 8. 4mm Hole - Hole estimation in solid line and variable thresholds is dot dashed when  $\epsilon_{exh} = 200\text{mbar}$  and  $M_{exh} = 200\text{mbar}$ . Reference hole diameter is dashed.



(a)  $\epsilon_{exh} = 0$



(b)  $\epsilon_{exh} = 200\text{mbar}$

Fig. 7. No Hole - Hole estimation in solid line and variable threshold is dot-dashed for different exhaust pressure sensor biases  $\epsilon_{exh}$  when  $M_{exh} = 200\text{mbar}$  is considered. Reference hole diameter is dashed.

bound, the threshold is more conservative as errors increase. A possible way to improve the threshold, it is to integrate statistical information of sensors uncertainties.

## REFERENCES

- [1] Ceccarelli, R., Canudas-de-Wit, C., Moulin, P. and A. Sciarretta, (2009, To Appear), Model-based Adaptive Observers for Intake Leakage Detection in Diesel Engines, *Proc. of American Control Conference 2009*
- [2] Canudas-de-Wit, C., and R. Horowitz, (1999), Observers for Tire/road Contact Friction using only wheel angular velocity information., *In 38th IEEE-CDC 1999*.
- [3] Canudas de Wit, R. Horowitz, and P. Tsiotras, (1999), Model-based observers for tire/road contact friction prediction, *In "New Directions in Nonlinear Observer Design"*, Nijmeijer, H. and T.I Fossen (Eds), Springer Verlag, Lectures Notes in control and Information Science, May 1999.
- [4] Canudas-de-Wit C., M. L. Petersen M.L., and Shiriaev A. "A New Nonlinear Observer For Tire/Road Distributed Contact Friction". IEEE Control and Decision Conference, Mahui, USA, Dec. 2003.
- [5] Guzzella, L., Onder, C.H., "Introduction to Modeling and Control of Internal Combustion Engine System", Springer-Verlag Berlin Heidelberg 2004
- [6] Heywood, J., "Internal Combustion Engine Fundamentals", McGraw-Hill, Inc, 1998
- [7] Nyberg, M. "Model-Based Diagnosis of an Automotive Engine Using Several Types of Fault Models" IEEE Transactions on control systems technology, vol. 10, n°5, September 2002
- [8] Nyberg, M., Sutte, T. "Model based diagnosis of the air path of an automotive diesel engine", Control Engineering Practice 12, pages 513-525, 2004
- [9] Isermann, R. "Supervision, fault-detection and fault diagnosis methods - an introduction", Control Engineering Practice, vol. 5, pages 639-652, 1997
- [10] Isermann, R. "Model Based Fault Detection and Diagnosis Methods" Proc. of the American Control Conference, 1996
- [11] Isermann, R., Schwarte, Kimmich "Model based fault detection of a diesel engine with turbocharger. A case study" Proceedings of the IFAC conference, 2004
- [12] Lee, B., Guezennec, Y., Rizzoni, G. "Model based fault diagnosis of spark ignition direct injection engine using nonlinear estimations", Proceedings of the SAE conference, 2005-01-0071, 2005
- [13] Albrecht, A., J. Chauvin, J., Lafossas, FA, Potteau, S., and Corde, G. "Development of highly premixed combustion Diesel engine model: from simulation to control design" SAE paper 2006-01-1072
- [14] J. Chauvin, J., Albrecht, A., Corde, G. and Petit, N., "Modelling and Control of a Diesel HCCI Engine" Fifth IFAC Symposium on Advanced in Automotive Control, ACC 2007