



HAL
open science

Aptamer-derived peptides as potent inhibitors of the oncogenic RhoGEF Tgat.

Nathalie Bouquier, Sylvie Fromont, Jean-Christophe Zeeh, Camille Auziol, Pauline Larrousse, Bruno Robert, Mahel Zeghouf, Jacqueline Cherfils, Anne Debant, Susanne Schmidt

► To cite this version:

Nathalie Bouquier, Sylvie Fromont, Jean-Christophe Zeeh, Camille Auziol, Pauline Larrousse, et al.. Aptamer-derived peptides as potent inhibitors of the oncogenic RhoGEF Tgat.. *Chemistry and Biology*, 2009, 16 (4), pp.391-400. <10.1016/j.chembiol.2009.02.006>. <hal-00392842>

HAL Id: hal-00392842

<https://hal.science/hal-00392842v1>

Submitted on 9 Jun 2009

HAL is a multi-disciplinary open access archive for the deposit and dissemination of scientific research documents, whether they are published or not. The documents may come from teaching and research institutions in France or abroad, or from public or private research centers.

L'archive ouverte pluridisciplinaire **HAL**, est destinée au dépôt et à la diffusion de documents scientifiques de niveau recherche, publiés ou non, émanant des établissements d'enseignement et de recherche français ou étrangers, des laboratoires publics ou privés.



HAL Authorization

**APTAMER-DERIVED PEPTIDES AS POTENT INHIBITORS
OF THE ONCOGENIC RHOGEF TGAT**

Nathalie Bouquier^{1,2}, Sylvie Fromont^{1,2}, Jean-Christophe Zeeh³, Camille Auziol^{1,2}, Pauline Larrousse^{1,2}, Bruno Robert⁴, Mahel Zeghouf³, Jacqueline Cherfils³, Anne Debant^{1,2#} and Susanne Schmidt^{1,2#}

¹ Université Montpellier 2 et 1, Centre de Recherche en Biochimie Macromoléculaire, IFR 122

² CNRS UMR 5237, 1919 Route de Mende, 34293 Montpellier, France

³ Laboratoire d'Enzymologie et Biochimie Structurales, CNRS, UPR 3082, 91198 Gif-sur-Yvette, France.

⁴ IRCM, Institut de Recherche en Cancérologie de Montpellier; INSERM, U896; Université Montpellier1; CRLC Val d'Aurelle Paul Lamarque, Montpellier, F-34298, France.

#Corresponding authors: Anne Debant : anne.debant@crbm.cnrs.fr, Susanne Schmidt : susanne.schmidt@crbm.cnrs.fr Tel: (33) 4 67 61 33 57 Fax: (33) 4 67 52 15 59

Running title : Targeting the Tgat oncogene with peptidic inhibitors

SUMMARY

Guanine nucleotide exchange factors (GEFs) activate the Rho GTPases by accelerating their GDP/GTP exchange rate. Some RhoGEFs have been isolated based on their oncogenic potency, and strategies to inhibit their activity are therefore actively being sought. In this study we devise a peptide inhibitor screening strategy to target the GEF activity of Tgat, an oncogenic isoform of the RhoGEF Trio, based on random mutations of the Trio inhibitor TRIP α , which we previously isolated using a peptide aptamer screen. This identifies one peptide, TRIP^{E32G}, which specifically inhibits Tgat GEF activity *in vitro* and significantly reduces Tgat-induced RhoA activation and foci formation. Furthermore, subcutaneous injection of cells expressing Tgat and TRIP^{E32G} into nude mice reduces the formation of Tgat-induced tumors. Our approach thus demonstrates that peptide aptamers are potent inhibitors that can be used to interfere with RhoGEF functions *in vivo*.

INTRODUCTION

By remodeling the actin cytoskeleton, Rho GTPases regulate various cellular processes, such as proliferation, migration, cell adhesion and cell shape (Etienne-Manneville and Hall, 2002). They are activated by the Dbl family of Rho Guanine Nucleotide Exchange Factors (RhoGEFs), which accelerates their GDP/GTP exchange rate (Rossman et al., 2005). RhoGEFs represent a large family (over seventy members in mammals) of complex proteins with numerous signaling domains, but they almost invariably contain a functional tandem, including a Dbl Homology (DH) domain responsible for guanine nucleotide exchange, followed by a Pleckstrin Homology (PH) domain, which targets the GEF to the plasma membrane and/or regulates nucleotide exchange (Chhatriwala et al., 2007; Lutz et al., 2007; Rojas et al., 2007; Rossman et al., 2003; Rossman et al., 2005). Deregulation of Rho GTPase function has been associated with various human disorders, including mostly cancer and metastasis, but also cardiovascular and hepatic disease, bacterial and viral pathogenesis, and developmental disorders, including neurodegenerative diseases (Sahai and Marshall, 2002; Toksoz and Merdek, 2002). Consistently, many Dbl family RhoGEFs have been isolated based on their oncogenic potency, which often results from a truncation of the protein, leading to uncontrolled GEF activity and subsequent aberrant Rho GTPase activation (Eva and Aaronson, 1985; Katzav et al., 1989; Miki et al., 1993; Whitehead et al., 1995; Whitehead et al., 1996).

Rho GTPases and their GEFs therefore represent challenging targets for inhibition, not only to understand their function but also in pathology, and strategies to inhibit their function are actively being sought (Bos et al., 2007). The main issue when trying to inhibit RhoGEFs is to achieve a high degree of specificity within such a complex and large family of related proteins, and to target protein-protein interactions which are not yet well characterized. To date only few strategies have been devised successfully, allowing the discovery of chemical

and peptidic RhoGEF inhibitors, that block the activation of Rho GTPases by their cognate GEFs (Blangy et al., 2006; Gao et al., 2004; Schmidt et al., 2002). We described previously peptide aptamer screening as such a strategy, which enabled us to discover the first RhoGEF inhibitor (Schmidt et al., 2002). Peptide aptamers are short peptides constrained by a bacterial Thioredoxin (TrxA) scaffold, which bind to their protein targets with high affinity (Baines and Colas, 2006; Hoppe-Seyler et al., 2004). This technology has been applied initially to the discovery of inhibitors against various intracellular targets, involved mainly in cell-cycle control or cell survival (Butz et al., 2000; Colas et al., 1996; Crnkovic-Mertens et al., 2003; Fabrizio et al., 1999; Martel et al., 2006; Nouvion et al., 2007). Peptide aptamers present interesting advantages over other classes of inhibitory molecules, mainly because of their simple design and their high degree of binding specificity, which enables them to discriminate between closely related proteins within a functional family. But most remarkably, these highly combinatorial proteins are screened and designed to function inside living cells and allow the study of protein function within complex regulatory networks (Bickle et al., 2006). The RhoGEF inhibitor we have isolated using this aptamer screening strategy, called TRIP α (Trio Inhibitory Peptide α), targets specifically the DH2-PH2 tandem of the RhoGEF Trio and inhibits its activation of RhoA both *in vitro* and in intact cells, reverting the neurite retraction phenotype induced by Trio DH2-PH2 in PC12 cells (Schmidt et al., 2002). Most interestingly, although TRIP α was initially selected with the TrxA scaffold, it remained equally active as a linear peptide (Schmidt et al., 2002).

The recently identified oncogenic RhoGEF Tgat is an interesting novel candidate target for such peptidic inhibitors. Indeed, Tgat has been identified from Adult T-Cell Leukemia (ATL) patient cells as a gene with oncogenic potency and originates from an alternate splicing of the *trio* gene (hence the name Tgat, for Trio-related transforming Gene in ATL Tumor cells) (Yoshizuka et al., 2004). Tgat retains only the RhoA-specific DH2 domain of Trio and,

instead of the associated PH2 domain, carries a unique C-terminal sequence of 15 amino acids. It induces cell transformation and tumor formation in nude mice (Yoshizuka et al., 2004) and has been proposed to enhance tumor invasion by stimulating Matrix MetalloProteinases (MMPs) via the RECK protein (Mori et al., 2007) and by activating the transcription factor NF- κ B, which plays a crucial role in tumorigenesis, including ATL (Yamada et al., 2007).

In this context, designing peptide inhibitors against the RhoGEF Tgat is very challenging, not only from a pathological point of view, but also from a conceptual perspective, addressing the important issue of specificity when targeting proteins which, like RhoGEFs, belong to families with high homologies.

In this study we devised an optimization screen based on the TRIP α peptide, which allowed us to identify a novel peptide that is active as a Tgat inhibitor, targeting its GEF activity *in vitro* in a highly specific manner. Moreover, it strongly reduces its oncogenic properties *in vivo*, most remarkably by decreasing foci formation and tumor development in nude mice. Our peptide optimization strategy identifies the first inhibitor of the Tgat oncogene, and demonstrates that aptamers can be used to interfere with RhoGEF functions *in vivo* with exquisite specificity.

RESULTS

The GEF activity of the DH domain is required for Tgat-induced transformation.

In order to design inhibitors that would target Tgat oncogenic activity, we first established whether the GEF activity of Tgat is involved in transformation. To do so, we designed a Tgat mutant, called Tgat^{L190E}, which harbors a point mutation in its DH domain, the equivalent mutation in Trio DH2-PH2 being known to abolish its exchange activity on RhoA (Figure 1A) (Bellanger et al., 2003). We established NIH3T3 cell lines stably expressing similar levels of GFP or GFP-tagged Tgat or Tgat^{L190E} (Figure 1B, lower panel), and analyzed the ability of these constructs to activate RhoA and to induce transformation. We measured RhoA activation in intact cells by pull-down of RhoA-GTP, using the RhoA-binding domain (RBD) of its effector Rhotekin fused to GST (Figure 1B-C). Tgat strongly stimulated RhoA activation (8-fold over control), while the GEF-impairing mutation completely abolished the formation RhoA-GTP in cells. We then tested the oncogenic properties of the different Tgat constructs, by scoring the formation of foci in the different cell lines (Figure 1D-E). While Tgat-expressing cells formed numerous foci, Tgat^{L190E}-expressing cells presented no foci after 3 weeks in culture, showing that the GEF activity of the DH domain is required for the transforming potential of Tgat. In addition, NIH3T3 cells stably expressing full length Trio did not exhibit any foci, showing that the transforming potential is not inherent to Trio but only to its oncogenic isoform Tgat (Figure 1D-E).

Strategy to identify a Tgat inhibitor.

Since the GEF activity of Tgat is necessary for transformation, molecules that block this biochemical activity could also inhibit its transforming potential. We previously identified a peptide aptamer, TRIP α , which targets the RhoA-specific DH2-PH2 tandem of Trio (Schmidt et al., 2002). As Tgat harbors the DH2 domain of Trio, we tested whether Tgat activity was

also inhibited by TRIP α . However, to our surprise, when tested in a [^3H]-GDP dissociation inhibition assay *in vitro*, TRIP α was only a weak inhibitor of Tgat ($K_{i\text{app}} = 89 \pm 33 \mu\text{M}$; see below).

We thus sought to optimize TRIP α inhibition efficiency, by first determining which amino acids are essential for its inhibition, using an Ala-Scan analysis. Each residue of the active core of TRIP α (amino acids 9-36; Schmidt et al., 2002) was mutated to alanine, except cysteines which were changed into serines. All TRIP α mutants were then tested for their inhibitory activity on Trio DH2-PH2 in [^3H]-GDP dissociation assays. This analysis mapped two essential regions of TRIP α , amino acids 9-20 and 28-33, where single mutations were sufficient to impair inhibition (Figure 2A). However, none of the mutants exhibited stronger inhibition towards Trio DH2-PH2 and were not further investigated on Tgat.

We next reasoned that peptides that would bind stronger to the GEF domain may also be better at inhibiting its activity. We thus generated a library of peptide aptamers derived from TRIP α by random mutagenesis, which we screened for GEF binding in a yeast two-hybrid assay. We chose a system in which the threshold of interaction detection can be modulated by the concentration of the 3-aminotriazole (3-AT) drug (Sardet et al., 1995). Since Tgat is toxic in yeast, we used Trio DH2-PH2 to screen this TRIP-like peptide library. Thirty-five independent clones bound to Trio DH2-PH2 at concentrations of 3-AT at which no interaction with TRIP α was detected anymore (80-120mM). These clones were then produced as GST-fusions and analyzed for their inhibition of Trio DH2-PH2, using the [^3H]-GDP dissociation assay. As shown in Figure 2B, 10 of them were stronger inhibitors than TRIP α . Analysis of their sequence revealed that they contained one to four mutations per peptide, and that, consistently, most of them resided within the two regions identified as crucial for the inhibitory properties of TRIP α (Figure 2B, shaded residues).

We then analyzed the inhibitory activity towards Tgat of TRIP^{E32G} and TRIP^{T16M/L17S}, the two TRIP-like peptides that displayed the highest inhibition on Trio DH2-PH2 (Figure 2B). Both peptides inhibited Tgat GEF activity in a dose-dependent manner in a kinetics fluorescence assay, while GST alone (not shown) or GST-TRIP α , at the same concentrations, had no effect (Figure 2C). Accordingly, the apparent inhibition constant ($K_{i\text{app}}$) of TRIP α towards Tgat was $89 \pm 33 \mu\text{M}$, and decreased to $7.4 \pm 5 \mu\text{M}$ for TRIP^{E32G} and $5.1 \pm 4 \mu\text{M}$ for TRIP^{T16M/L17S} (Figure 2D). These data show that TRIP^{E32G} and TRIP^{T16M/L17S} are both about 15 times more efficient than TRIP α at inhibiting the exchange activity of Tgat.

Interestingly, the optimized peptides were equally efficient on Tgat and on Trio DH2, as shown by their similar $K_{i\text{app}}$ values (Figure 2C and 2D). This suggests that the unique C-terminal extension of Tgat is not involved in the inhibitory mechanism of the optimized peptides, and is consistent with the fact that this sequence does not interfere with the GEF activity *in vitro* (data not shown).

Inhibition by TRIP peptides is specific for Tgat.

We then analyzed the specificity of the optimized TRIP peptides, by testing their inhibitory properties on other related RhoGEFs. We had shown previously that TRIP α is not active on the RhoA-specific GEFs p115RhoGEF, Lbc, p63RhoGEF, nor on Db1 (Schmidt et al., 2002 and unpublished results). Similarly, when tested in mant-GTP fluorescence kinetics at a concentration at which Tgat is fully inhibited, TRIP^{E32G} and TRIP^{T16M/L17S} had no effect on the exchange activities of these closely related RhoGEF/Rho-GTPase tandems, p115RhoGEF/RhoA, Lbc/RhoA, Db1/RhoA, and even the very closely Trio-related p63RhoGEF/RhoA (70% identity within the DH-PH module), or Trio DH1-PH1/RhoG (40% identity with Tgat) (Figure 3). Taken together, these data show that the optimized TRIP peptides are highly specific for Tgat and Trio DH2.

TRIP^{E32G} inhibits the transforming activity of Tgat in vivo.

We next analyzed whether our TRIP-like peptides inhibited Tgat-mediated RhoA activation in intact cells. For that purpose, NIH3T3 cells stably expressing Tgat were transfected with the GFP-tagged TRIP-like peptides or GFP alone, and RhoA activation levels were assessed by the GST-RBD pull-down assay (Figure 4). Although TRIP^{E32G} and TRIP^{T16M/L17S} inhibited the *in vitro* GEF activity of Tgat to a similar extent, TRIP^{E32G} was more efficient than TRIP^{T16M/L17S} at inhibiting Tgat-mediated activation of RhoA in cells (Figure 4A-B). These data show that, in addition to its effect on *in vitro* guanine nucleotide exchange, TRIP^{E32G} inhibits Tgat GEF activity also in intact cells.

In order to verify the exquisite specificity of our peptide towards Tgat/DH2 *in vivo*, we analyzed by GST-RBD pull-down assay whether TRIP^{E32G} could inhibit oncogenic Dbl-mediated RhoA activation in intact cells. Figure 4C shows that, in contrast to its effect on Tgat activity, TRIP^{E32G} was not able to inhibit RhoA activation by Dbl, confirming the *in vitro* specificity of TRIP^{E32G} towards Tgat.

We then investigated whether TRIP^{E32G} was able to inhibit Tgat-induced transformation. To do so, we stably expressed GST or GST-TRIP^{E32G} in Tgat-expressing NIH3T3 cells and characterized their transforming potential. After 3 weeks of culture, the foci present in Tgat-expressing cells were severely reduced when co-expressing TRIP^{E32G} (Figure 5A-B). This reduction is not due to a non-specific effect of TRIP^{E32G} on cell proliferation or apoptosis (data not shown). These data show therefore that targeting Tgat GEF activity with TRIP^{E32G} is sufficient to impair Tgat transforming activity.

To further establish the inhibitory effect of TRIP^{E32G} on Tgat transforming activity *in vivo*, we subcutaneously inoculated Balb/c nude mice with NIH3T3 cells expressing either Tgat, or Tgat and TRIP^{E32G}, and analyzed their effect on tumor formation. Tgat-transformed cells produced tumors in ten out of twelve mice. Remarkably, when TRIP^{E32G} was co-expressed

with Tgat, only seven mice had tumors and we observed a delay of about three weeks in the formation of tumors (Figure 5C). In addition, even though tumor formation was not abolished, the weight of the tumors was significantly reduced when TRIP^{E32G} was expressed (Figure 5D). Altogether, these data show that expression of TRIP^{E32G} strongly reduces Tgat transformation activity in cells and affects tumor formation in nude mice, most likely by inhibiting Tgat-mediated GTP loading of RhoA.

DISCUSSION

Peptide aptamers as new inhibitors of RhoGEFs.

Because of their deregulation in many human disorders including cancer, Rho GTPases and their activating GEFs represent challenging targets for inhibition. In humans there are only 20 Rho GTPases but more than 70 RhoGEFs, and it appears that signaling specificity is mostly determined by the GEFs, which activate the GTPases at defined timing and location. RhoGEF inhibitors therefore represent an emerging field of investigation.

Here we developed a peptide aptamer screening strategy to inhibit the RhoGEF Tgat, a potential target in the ATL disease. Since Tgat is an isoform of the RhoGEF Trio, which includes the RhoA-specific DH2 domain plus a unique C-terminal sequence, we based our screen on our previously identified Trio inhibitor TRIP α , the first peptidic RhoGEF inhibitor described, which targets the DH2-PH2 domain of Trio (Schmidt et al., 2002). Intriguingly, despite the fact that Tgat harbors the Trio DH2 domain, our original TRIP α inhibitor was rather ineffective at inhibiting Tgat. This suggests that the PH2 domain of Trio is involved in the mechanism of action of TRIP α , and that its replacement by the C-terminal extension decreases TRIP α 's ability to inhibit the GEF activity of Tgat.

We show here that GEF inhibitors selected with the peptide aptamer screening approach are readily amenable to structure-activity relationship analysis and optimization. Of the 28 residues located in the active core of TRIP α , alanine scanning mapped 9 residues in two regions (residues 9-20 and 28-33) that were critical for the catalytic activity, while 6 had a moderate effect and the others had no effect. We also show that peptide aptamer optimization can be achieved by random mutagenesis combined with a selection screen based on interaction strength. At least one third of the isolated clones yielded stronger inhibition, thus validating the rationale of the screen. The two selected peptides, TRIP^{E32G} and TRIP^{T16M/L17S}, were 15-fold more efficient than TRIP α and inhibited Tgat GEF activity at concentrations

lying in the low micromolar range. Interestingly, mutations found in these clones also fell within the two important regions identified by the Ala-scan. Furthermore, this approach allowed us to turn TRIP α into a Tgat inhibitor, which could be achieved with as few as one mutation, E32G. It remains to be determined whether these different amino acids are important for binding to the GEF and/or for inhibition of the exchange reaction.

It should be emphasized that our screening and optimization method is effective, irrespective of the inhibitory mechanism, which is of big advantage for the discovery of inhibitors of protein-protein interactions. The way the original screen was performed, i.e. two-hybrid screening with the GEF as bait in the absence of GTPase, strongly suggests that the target of the peptides is the GEF itself, rather than the GTPase. This is reinforced by the fact that the peptides do not inhibit spontaneous GDP release from RhoA using [³H]-GDP-loaded RhoA (data not shown), and by our specificity data *in vitro* and in intact cells, which show that other GEF activities towards RhoA are not inhibited (Figure 3 and 4). At this stage we cannot, however, distinguish between competitive and allosteric inhibition, or even a less likely uncompetitive mechanism.

Remarkably, the characterization of our optimized TRIP peptides clearly shows that gain of efficiency is not associated with loss of specificity. Indeed, none of the RhoA-activating GEFs we tested, in particular the very closely related p63RhoGEF, were affected by either TRIP^{E32G} or TRIP^{T16M/L17S}. In addition, the TRIP peptides did not affect the activity of GEFs with different specificity such as the RhoG/Rac1-specific TrioDH1-PH1.

Peptide aptamers are functional in vivo

Our screening method demonstrates that TRIP^{E32G} is not only effective and specific at inhibiting Tgat GEF activity *in vitro*, but that it also blocks Tgat-induced cell transformation and tumor formation *in vivo*. This is the first example of a peptidic RhoGEF inhibitor that is

functional *in vivo*, and demonstrates that aptamers can be used as active peptides to perturb the function of GEFs *in vivo*. In this context, efficient *in vivo* delivery is a critical issue when working with peptides. To circumvent this problem, the use of recently developed cell penetrating peptides represents a good means of delivery for TRIP^{E32G}, and could be an attractive strategy to investigate the contribution of Tgat in leukemogenesis. Indeed, to date, the incidence of Tgat in ATL leukemogenesis is unknown, but given the strong effect of Tgat on RhoA activation and transformation, we can hypothesize that Tgat is involved in the progression of ATL by contributing to RhoA-mediated proliferation and/or metastasis. Our series of TRIP peptides should now prove useful tools to decipher the cellular role of Tgat.

Peptide aptamers versus other GEF inhibitor screening strategies.

Besides our peptide aptamer screening approach, other strategies have recently been devised to discover chemical inhibitors of Rho GTPase/GEF tandems, and also other classes of small G proteins, such as the Arf family and their activating GEFs (Blangy et al., 2006; Desire et al., 2005; Gao et al., 2004; Mayer et al., 2001; Shutes et al., 2007; Viaud et al., 2007). Computer-assisted virtual screening, for example, identified the NSC23766 compound, based on structure-function information of the Rac1/Tiam1 complex. This powerful molecule inhibits specifically Rac1-induced events *in vitro* and *in vivo*, however the targeted associated RhoGEFs include at least Tiam1 and Trio DH1-PH1 (Gao et al., 2004). *In silico* screening also yielded the LM11 compound, which inhibits specifically the ARNO/Arf1 interface *in vitro* and is active in cells (Viaud et al., 2007). Given their membrane permeability, both NSC23766 and LM11 have the advantage of being easily applied *in vivo*.

The Yeast Exchange Assay is another screening method that allowed the identification of the TrioDH1-PH1 specific NPPD compound and its analogues (Blangy et al., 2006). Like peptide

aptamer screening, this strategy has the advantage over virtual screening of identifying inhibitors directly in cells, and without any bias as to the targeted interaction site.

Finally, *in vitro* RNA-aptamer screening selected the RNA aptamer M69 as an inhibitor of the Cytohesin/Arf1 tandem (Mayer et al., 2001). Like peptide-aptamers, these RNA aptamers are highly combinatorial and easily screened, but their application as potential drugs remains limited, due to difficult *in vivo* delivery. To circumvent this problem, RNA-aptamer-displacement represents an elegant method, in which a small-molecule library is screened for compounds that displace the RNA-aptamer from its target and reproduce its inhibitory activity (Hafner et al., 2006).

Our study shows that peptide aptamer screening represents a valid strategy for inhibitor identification that can be applied to a variety of different proteins, because of the *in vivo* screening method and the highly combinatorial libraries available, yielding strong affinity inhibitors. This is illustrated here by the identification of a highly specific peptidic RhoGEF inhibitor targeting the Tgat oncogene *in vitro* and *in vivo*.

SIGNIFICANCE

When trying to inhibit signaling pathways controlled by small G proteins and their activating GEFs, the challenge is that these are not mere enzymes with a well-defined active site that can be blocked. Rather, protein-protein interactions have to be targeted and the lack of reactive pockets to which inhibitors could bind is a challenging issue. This might in part explain why, although oncogenic Ras has been discovered more than 20 years ago, no inhibitor with clinical validation has been identified. Therefore, research has focused on trying to inhibit the guanine nucleotide exchange factors instead, and recent studies report the successful identification of such inhibitors.

The power of the strategy we used here to identify the TRIP peptides relies on the screening of a highly combinatorial aptamer library, generating immense possibilities of random peptides. This variety makes peptide aptamers very suitable molecules to inhibit complex protein-protein interactions such as the tandem RhoGEF/GTPase, and to discriminate between closely related proteins. One major advantage of this kind of approach is that the screening is cell-based, which gives a direct readout for toxicity and is more stringent. Moreover, peptide aptamers do not mimic cellular targets, which could have non-desired effects in cells. In addition, to circumvent the problem of *in vivo* delivery when using peptide aptamers, aptamer-displacement screens can be performed, in order to convert an aptamer into a small compound inhibitor (Baines and Colas, 2006). The advantage is that the corresponding compound targets the same site and shares the same properties as the already characterized peptide.

In conclusion, peptide aptamers represent a promising alternative for the discovery of leads for new therapeutic drugs.

EXPERIMENTAL PROCEDURES

DNA constructs - Tgat (aa 1-255) was designed by ligating dimerized oligonucleotides coding for the specific C-terminus of Tgat (15 aa) to the Trio DH2 domain (residues 1862-2101, corresponding to aa 1-240). The oligonucleotide sequences are available upon request. The Tgat^{L190E} mutant was obtained using the Quick Change Site Directed Mutagenesis Kit (Stratagene Inc.), according to the manufacturer's instructions.

To create stable NIH3T3 cell lines, GFP-tagged Tgat, Tgat^{L190E} and full length Trio were cloned into the puromycin-resistant retroviral vector pBabePuro. GST-tagged TRIP peptides were cloned into the G418-resistant retroviral vector pLXSN. For transient transfections, both Tgat and TRIP peptides were cloned into the pEGFP vector (Clontech Inc.). Myc-Dbl was a kind gift of Michael Olson (Beatson Institute for Cancer Research, Glasgow). For *in vitro* GEF assays, Tgat (aa 1-255) was fused to maltose-binding protein (MBP) by cloning into a modified pMAL C2X vector (New England Biolabs Inc.). The TRIP peptides were fused to GST by cloning into the pGEX-5X2 vector (GE Healthcare Inc.). All constructs were checked by sequencing.

Expression and purification of recombinant proteins - Tgat. MBP-Tgat and MBP-DH2 expression in *E. coli* was induced for 24h at 16°C with 0.1 mM isopropylthio-galactopyranoside (IPTG). After cell lysis (in 50 mM Tris pH 7.5, 1 mM EDTA, 2 mM MgCl₂, 1 mM DTT), the suspension was centrifuged at 10,000g for 20 min, then at 400,000g for 1h30. The supernatant was applied to a Q-Sepharose column fast flow (GE Healthcare) equilibrated with lysis buffer. The protein was eluted with a linear gradient of 0-250 mM NaCl in 50 mM Tris pH 7.5. Fractions containing the protein were adjusted to a concentration of 2 M NaCl and loaded on a Phenyl sepharose Fast flow High Sub (GE Healthcare Inc.). The

protein was eluted with a linear gradient of 2-0 M NaCl in 50 mM Tris pH 7.5. The purified proteins were concentrated on a Vivaspin concentrator (Vivascience AG Inc.) at 18 mg/mL.

Other proteins. Recombinant GST-Trio DH2-PH2, GST-Trio DH1-PH1, GST-Dbl (DH-PH domain), GST-Lbc (DH-PH), GST-p63RhoGEF (DH domain) and GST-RhoG were purified as described previously (Schmidt et al., 2002; Souchet et al., 2002). Expression and purification of GST-p115RhoGEF using the baculo virus system will be described elsewhere.

GST-Peptides. GST-TRIP peptides were purified as described (Schmidt et al., 2002), except that the cell lysate was centrifuged as above, before loading on a GSTrap Fast Flow column (GE Healthcare Inc.) equilibrated with lysis buffer. Peptides were eluted with reduced glutathione (10 mM) in Tris 50 mM pH 7.5 and concentrated on Vivaspin concentrator at about 5-10 mg/mL.

Optimization of TRIP α - Alanine-scanning of TRIP α . Every amino acid of the active core of TRIP α (amino acids 9-36) was mutated to alanine (or serine for cysteine residues) by site directed mutagenesis of GST-TRIP α . Each TRIP α mutant was tested for its inhibitory activity on DH2-PH2 in [³H]-GDP dissociation assays.

Two-hybrid screening of TRIP α -like peptides. An aptamer library derived from TRIP α was created by PCR-based random mutagenesis of TRIP α inserted into the yeast two-hybrid vector pPC86. Sequencing of a statistically representative number of clones yielded a mutation rate of ~3 mutations/clone. 6×10^5 independent clones were screened for interactors, using Trio DH2-PH2 (in the pPC97 vector) as a bait, in the MAV103 yeast strain, on high concentrations of 3-AT (3-amino-triazol, Sigma) (80-120mM). Selected peptides were then produced as GST-fusions and analyzed for their inhibition of Trio DH2-PH2 using the [³H]-GDP dissociation assay.

Nucleotide exchange kinetics assay - Specific exchange rates of Tgat were measured with a fluorescence-based kinetics assay, using a 6His-RhoA construct (gift of Dr Derewenda, Charlottesville University, Virginia) purified as described (Oleksy et al., 2004). Exchange activities were followed by fluorescence resonance energy transfer (FRET) between the GTPase tryptophanes ($\lambda_{ex}=292\text{nm}$) and the methylantranyloil group of mant-GTP ($\lambda_{em}=440\text{nm}$) as described (Zeeh et al., 2006). All fluorescence measurements were performed with a CARY Eclipse fluorimeter (Varian). For each k_{obs} determination, RhoA ($1\mu\text{M}$) and Tgat (or Trio DH2) were preincubated 3 min at 25°C in $700\mu\text{L}$ reaction buffer (50mM Tris pH 7.5, 50mM NaCl, 2mM MgCl_2 , 1mM DTT). The exchange reaction was initiated by $10\mu\text{M}$ mant-GTP and measured for 10 min until the plateau was reached.

k_{obs} were calculated by fitting the FRET fluorescence changes to a single exponential, using the Kaleidagraph software. Specific exchange activities were calculated by linear regression of k_{obs} values determined for a range of GEF concentrations (0, 0.2, 0.3, 0.4, 0.5 and $1\mu\text{M}$).

Nucleotide exchange inhibition assays - Radioactive [^3H]-GDP dissociation assays were performed as described (Schmidt et al., 2002). Briefly, $0.15\mu\text{M}$ GST-Trio DH2-PH2 was preincubated for 15 min with $3\mu\text{M}$ of GST-TRIP inhibitors. The reaction was started by addition of $0.4\mu\text{M}$ [^3H]-GDP-loaded RhoA and 1mM GTP, and the reaction mix was filtered after 0 min and 15 min incubation at 25°C . Inhibition efficiency is expressed as the ratio between [^3H]-GDP-bound RhoA at 15 and 0 min.

Apparent inhibition constants (K_{iapp}) of TRIP-like peptides were determined from k_{obs} values obtained at increasing peptide concentrations using the above fluorescence nucleotide exchange assay. K_{iapp} was calculated from the hyperbolic fit of k_{obs} values as a function of the inhibitor concentration as described (Zeeh et al., 2006).

TRIP-like peptide specificity was assayed using mant-GTP fluorescence kinetics ($\lambda_{\text{ex}}=360\text{nm}$, $\lambda_{\text{em}}=460\text{nm}$) in a FLX800 Microplate Fluorescence Reader (BioTek Instruments). $0.5\mu\text{M}$ Tgat, p63RhoGEF, Lbc, and p115RhoGEF, or $0.1\mu\text{M}$ Dbl and Trio DH1-PH1 were preincubated 5 min at 25°C in the presence of $20\mu\text{M}$ GST, GST-TRIP^{E32G} or TRIP^{T16M/L17S} and $1\mu\text{M}$ mant-GTP. The exchange reaction was initiated by addition of $1\mu\text{M}$ RhoA or RhoG and monitored for 10 min.

Cell lines, transfection and focus formation assay - NIH3T3 cells were maintained as described previously (Sirvent et al., 2007).

Transient transfection experiments were performed using the Jet PEI reagent, according to the manufacturer's protocol (QBiogene Inc.). NIH3T3 cell lines stably expressing GFP-Tgat, GFP-Tgat^{L190E}, or GFP-Trio, with or without the GST-TRIP peptides, were generated as follows : the indicated retroviral constructs were transfected into BOSC packaging cells, using the Lipofectamine reagent (Invitrogen Inc.). Forty-eight hours after transfection, virus-containing supernatants were collected and used to infect NIH3T3 cells. Infected cells were selected with $6\mu\text{g/mL}$ puromycin and/or 1mg/mL G418 and stable transfectants were pooled after selection. Tgat or TRIP mRNA levels in the different cell lines were monitored by RT-PCR, and protein expression levels by Western blot analysis using a polyclonal anti-GFP antibody (Torrey Pines Laboratories).

Focus formation assays were performed using stable NIH3T3 cell lines as indicated, seeded at 5×10^4 cells in 6-well plates and maintained for 15 to 21 days in 10% FBS. Medium was renewed every two days. After staining with Crystal Violet (1%), plates were photographed and foci were scored using the Metamorph software. All experiments were done in triplicate.

RhoA activation assay in cells - The level of GTP-bound RhoA was measured by a GST pull-down assay as described (Schmidt et al., 2002). Briefly, cell lysates were incubated with

glutathione beads coated with the recombinant Rho-binding domain (RBD) of the RhoA-specific effector Rhotekin (Cytoskeleton Inc.). Total or GTP-bound RhoA in the samples was revealed by Western blot analysis, using a monoclonal anti-RhoA antibody (Santa-Cruz Biotechnology Inc.).

Mice and xenografting - Female Balb/c nu/nu mice were purchased from Charles River France and used at 6-8 weeks of age. 12 Balb/c nu/nu mice were subcutaneously grafted with 2×10^6 cells of each cell line on both sides (Tgat on the left and Tgat+TRIP^{E32G} on the right flank of the leg). The appearance of tumors was scored visually every week. 10 weeks post graft, mice were euthanized and tumors excised and weighed. mRNA and protein levels in the tumors were verified by RT-PCR and Western blot (data not shown). All experiments on mice have been approved by the internal ethical committee of the IRCM and have been performed by B.R. under the authorization number N° 34.156, in the animal facility with agreement N° B34-172-27.

REFERENCES

- Baines, I. C., and Colas, P. (2006). Peptide aptamers as guides for small-molecule drug discovery. *Drug Discov Today* 11, 334-341.
- Bellanger, J. M., Estrach, S., Schmidt, S., Briancon-Marjollet, A., Zugasti, O., Fromont, S., and Debant, A. (2003). Different regulation of the Trio Dbl-Homology domains by their associated PH domains. *Biol Cell* 95, 625-634.
- Bickle, M. B., Dusserre, E., Moncorge, O., Bottin, H., and Colas, P. (2006). Selection and characterization of large collections of peptide aptamers through optimized yeast two-hybrid procedures. *Nat Protoc* 1, 1066-1091.
- Blangy, A., Bouquier, N., Gauthier-Rouviere, C., Schmidt, S., Debant, A., Leonetti, J. P., and Fort, P. (2006). Identification of TRIO-GEFD1 chemical inhibitors using the yeast exchange assay. *Biol Cell* 98, 511-522.
- Bos, J. L., Rehmann, H., and Wittinghofer, A. (2007). GEFs and GAPs: critical elements in the control of small G proteins. *Cell* 129, 865-877.
- Butz, K., Denk, C., Ullmann, A., Scheffner, M., and Hoppe-Seyler, F. (2000). Induction of apoptosis in human papillomaviruspositive cancer cells by peptide aptamers targeting the viral E6 oncoprotein. *Proc Natl Acad Sci U S A* 97, 6693-6697.
- Chhatriwala, M. K., Betts, L., Worthylake, D. K., and Sondek, J. (2007). The DH and PH domains of Trio coordinately engage Rho GTPases for their efficient activation. *J Mol Biol* 368, 1307-1320.
- Colas, P., Cohen, B., Jessen, T., Grishina, I., McCoy, J., and Brent, R. (1996). Genetic selection of peptide aptamers that recognize and inhibit cyclin-dependent kinase 2. *Nature* 380, 548-550.

Crnkovic-Mertens, I., Hoppe-Seyler, F., and Butz, K. (2003). Induction of apoptosis in tumor cells by siRNA-mediated silencing of the livin/ML-IAP/KIAP gene. *Oncogene* 22, 8330-8336.

Desire, L., Bourdin, J., Loiseau, N., Peillon, H., Picard, V., De Oliveira, C., Bachelot, F., Leblond, B., Taverne, T., Beausoleil, E., et al. (2005). RAC1 inhibition targets amyloid precursor protein processing by gamma-secretase and decreases Abeta production in vitro and in vivo. *J Biol Chem* 280, 37516-37525.

Etienne-Manneville, S., and Hall, A. (2002). Rho GTPases in cell biology. *Nature* 420, 629-635.

Eva, A., and Aaronson, S. A. (1985). Isolation of a new human oncogene from a diffuse B-cell lymphoma. *Nature* 316, 273-275.

Fabbrizio, E., Le Cam, L., Polanowska, J., Kaczorek, M., Lamb, N., Brent, R., and Sardet, C. (1999). Inhibition of mammalian cell proliferation by genetically selected peptide aptamers that functionally antagonize E2F activity. *Oncogene* 18, 4357-4363.

Gao, Y., Dickerson, J. B., Guo, F., Zheng, J., and Zheng, Y. (2004). Rational design and characterization of a Rac GTPase-specific small molecule inhibitor. *Proc Natl Acad Sci U S A* 101, 7618-7623.

Hafner, M., Schmitz, A., Grune, I., Srivatsan, S. G., Paul, B., Kolanus, W., Quast, T., Kremmer, E., Bauer, I., and Famulok, M. (2006). Inhibition of cytohesins by SecinH3 leads to hepatic insulin resistance. *Nature* 444, 941-944.

Hoppe-Seyler, F., Crnkovic-Mertens, I., Tomai, E., and Butz, K. (2004). Peptide aptamers: specific inhibitors of protein function. *Curr Mol Med* 4, 529-538.

Katzav, S., Martin-Zanca, D., and Barbacid, M. (1989). vav, a novel human oncogene derived from a locus ubiquitously expressed in hematopoietic cells. *Embo J* 8, 2283-2290.

Lutz, S., Shankaranarayanan, A., Coco, C., Ridilla, M., Nance, M. R., Vettel, C., Baltus, D., Evelyn, C. R., Neubig, R. R., Wieland, T., and Tesmer, J. J. (2007). Structure of Galphaq-p63RhoGEF-RhoA complex reveals a pathway for the activation of RhoA by GPCRs. *Science* 318, 1923-1927.

Martel, V., Filhol, O., Colas, P., and Cochet, C. (2006). p53-dependent inhibition of mammalian cell survival by a genetically selected peptide aptamer that targets the regulatory subunit of protein kinase CK2. *Oncogene* 25, 7343-7353.

Mayer, G., Blind, M., Nagel, W., Bohm, T., Knorr, T., Jackson, C. L., Kolanus, W., and Famulok, M. (2001). Controlling small guanine-nucleotide-exchange factor function through cytoplasmic RNA intramers. *Proc Natl Acad Sci U S A* 98, 4961-4965.

Miki, T., Smith, C. L., Long, J. E., Eva, A., and Fleming, T. P. (1993). Oncogene *ect2* is related to regulators of small GTP-binding proteins. *Nature* 362, 462-465.

Mori, T., Moriuchi, R., Okazaki, E., Yamada, K., and Katamine, S. (2007). Tgat oncoprotein functions as a inhibitor of RECK by association of the unique C-terminal region. *Biochem Biophys Res Commun* 355, 937-943.

Nouvion, A. L., Thibaut, J., Lohez, O. D., Venet, S., Colas, P., Gillet, G., and Lalle, P. (2007). Modulation of Nr-13 antideath activity by peptide aptamers. *Oncogene* 26, 701-710.

Oleksy, A., Barton, H., Devedjiev, Y., Purdy, M., Derewenda, U., Otlewski, J., and Derewenda, Z. S. (2004). Preliminary crystallographic analysis of the complex of the human GTPase RhoA with the DH/PH tandem of PDZ-RhoGEF. *Acta Crystallogr D Biol Crystallogr* 60, 740-742.

Rojas, R. J., Yohe, M. E., Gershburg, S., Kawano, T., Kozasa, T., and Sondek, J. (2007). Galphaq directly activates p63RhoGEF and Trio via a conserved extension of the Dbl homology-associated pleckstrin homology domain. *J Biol Chem* 282, 29201-29210.

Rossman, K. L., Cheng, L., Mahon, G. M., Rojas, R. J., Snyder, J. T., Whitehead, I. P., and Sondek, J. (2003). Multifunctional roles for the PH domain of Dbs in regulating Rho GTPase activation. *J Biol Chem* 278, 18393-18400.

Rossman, K. L., Der, C. J., and Sondek, J. (2005). GEF means go: turning on RHO GTPases with guanine nucleotide-exchange factors. *Nat Rev Mol Cell Biol* 6, 167-180.

Sahai, E., and Marshall, C. J. (2002). RHO-GTPases and cancer. *Nat Rev Cancer* 2, 133-142.

Sardet, C., Vidal, M., Cobrinik, D., Geng, Y., Onufryk, C., Chen, A., and Weinberg, R. A. (1995). E2F-4 and E2F-5, two members of the E2F family, are expressed in the early phases of the cell cycle. *Proc Natl Acad Sci U S A* 92, 2403-2407.

Schmidt, S., Diriong, S., Mery, J., Fabbriozio, E., and Debant, A. (2002). Identification of the first Rho-GEF inhibitor, TRIPalpha, which targets the RhoA-specific GEF domain of Trio. *FEBS Lett* 523, 35-42.

Shutes, A., Onesto, C., Picard, V., Leblond, B., Schweighoffer, F., and Der, C. J. (2007). Specificity and mechanism of action of EHT 1864, a novel small molecule inhibitor of Rac family small GTPases. *J Biol Chem* 282, 35666-35678.

Sirvent, A., Boureux, A., Simon, V., Leroy, C., and Roche, S. (2007). The tyrosine kinase Abl is required for Src-transforming activity in mouse fibroblasts and human breast cancer cells. *Oncogene* 26, 7313-7323.

Souchet, M., Portales-Casamar, E., Mazurais, D., Schmidt, S., Leger, I., Javre, J. L., Robert, P., Berrebi-Bertrand, I., Bril, A., Gout, B., et al. (2002). Human p63RhoGEF, a novel RhoA-specific guanine nucleotide exchange factor, is localized in cardiac sarcomere. *J Cell Sci* 115, 629-640.

Toksoz, D., and Merdek, K. D. (2002). The Rho small GTPase: functions in health and disease. *Histol Histopathol* 17, 915-927.

Viaud, J., Zeghouf, M., Barelli, H., Zeeh, J. C., Padilla, A., Guibert, B., Chardin, P., Royer, C. A., Cherfils, J., and Chavanieu, A. (2007). Structure-based discovery of an inhibitor of Arf activation by Sec7 domains through targeting of protein-protein complexes. *Proc Natl Acad Sci U S A* 104, 10370-10375.

Whitehead, I., Kirk, H., Tognon, C., Trigo-Gonzalez, G., and Kay, R. (1995). Expression cloning of lfc, a novel oncogene with structural similarities to guanine nucleotide exchange factors and to the regulatory region of protein kinase C. *J Biol Chem* 270, 18388-18395.

Whitehead, I. P., Khosravi-Far, R., Kirk, H., Trigo-Gonzalez, G., Der, C. J., and Kay, R. (1996). Expression cloning of lsc, a novel oncogene with structural similarities to the Dbl family of guanine nucleotide exchange factors. *J Biol Chem* 271, 18643-18650.

Yamada, K., Moriuchi, R., Mori, T., Okazaki, E., Kohno, T., Nagayasu, T., Matsuyama, T., and Katamine, S. (2007). Tgat, a Rho-specific guanine nucleotide exchange factor, activates NF-kappaB via physical association with IkappaB kinase complexes. *Biochem Biophys Res Commun* 355, 269-274.

Yoshizuka, N., Moriuchi, R., Mori, T., Yamada, K., Hasegawa, S., Maeda, T., Shimada, T., Yamada, Y., Kamihira, S., Tomonaga, M., and Katamine, S. (2004). An alternative transcript derived from the trio locus encodes a guanosine nucleotide exchange factor with mouse cell-transforming potential. *J Biol Chem* 279, 43998-44004.

Zeeh, J. C., Zeghouf, M., Grauffel, C., Guibert, B., Martin, E., Dejaegere, A., and Cherfils, J. (2006). Dual specificity of the interfacial inhibitor brefeldin a for arf proteins and sec7 domains. *J Biol Chem* 281, 11805-11814.

ACKNOWLEDGEMENTS

We thank Michel Brissac and Imad Aït Arsa for technical assistance in manipulating the nude mice in the animal facility of CRLC Val d'Aurelle in Montpellier, Claire Macari and Sandra Pierredon for technical help, Alexandra Joubert (LEBS, CNRS, Gif-sur-Yvette) for the gift of purified p115RhoGEF, Pierre Travo, Julien Cau and Sylvain De Rossi from Montpellier Rio Imaging for invaluable help and constant interest. Jean-Michel Bellanger, Philippe Pasero, Claude Sardet and Gilles Divita are acknowledged for helpful discussion and critical reading of the manuscript.

This work was supported by grants from the CNRS, the Agence Nationale de la Recherche ANR-PCV (Physique et Chimie du Vivant) (A.D. and J.C.), the Association pour la Recherche contre le Cancer (grant #2736 to A.D., PhD grants to C.A. and J.C.Z). All authors except Bruno Robert are members of the CNRS consortium GDR2823.

FIGURE LEGENDS

Figure 1: The transforming activity of Tgat requires its GEF activity towards RhoA

A. Schematic representation of Trio and its splice variant Tgat, and the Tgat mutant used in this study. **B.** RhoA activation assay. Lysates of NIH3T3 cells stably expressing GFP, GFP-Tgat, or GFP-Tgat^{L190E} were subjected to GST-pulldown using recombinant RBD (RhoA-binding domain of Rhotekin). The levels of GTP-bound RhoA (top panel) and total RhoA protein (middle panel) were assessed by Western Blot with a monoclonal anti-RhoA antibody. All GEF constructs were expressed at a similar level as shown by Western blotting using an anti-GFP antibody (lower panel). **C.** Quantification of the RhoA activation assay from at least three independent experiments. “Fold RhoA activation” means the amount of RhoA-GTP in the sample, as compared to the amount in the GFP control, which was set to 1. **D.** Focus formation assay of NIH3T3 cells stably expressing GFP, GFP-Tgat, GFP-Tgat^{L190E} or GFP-Trio. **E.** Quantification of three independent focus formation assays. The number of foci induced by Tgat was set to 100%. Error bars represent standard deviation in all graphs.

Figure 2: Identification and characterization of optimized inhibitory TRIP-like peptides

A. Alanine-scanning of the active core of TRIP α . Inhibition efficiency of the mutated peptides was measured by [³H]-GDP dissociation assays using Trio DH2-PH2, and compared to the original TRIP α peptide. Black bold letters: residues strictly required for inhibition; grey bold letters: residues retaining a weak inhibitory potential. All the other residues are non essential. Shaded residues: regions (aa 9-20 and 28-33) that emerge as being essential for TRIP α activity. **B.** Amino acid sequence of the optimized TRIP-like peptides, obtained by random mutagenesis of the original TRIP α peptide. Inhibition efficiency was measured on Trio DH2-PH2 and compared to TRIP α , as described in A. “Fold over TRIP α inhibition” means stronger inhibition at the same inhibitor concentration (inhibition by TRIP α was set to

1). **C.** Inhibition of Tgat GEF activity by TRIP^{T16M/L17S} and TRIP^{E32G} *in vitro*. FRET fluorescence exchange assays were performed using constant concentrations of RhoA (1 μ M), equal amounts (0.5 μ M) of Tgat (left panel) or Trio DH2 (right panel), and increasing concentrations of GST-TRIP peptides, up to 100 μ M. Results were expressed as k_{obs} values plotted as a function of the indicated TRIP inhibitor concentration. **D.** Apparent inhibition constants (Ki_{app}) of the TRIP peptides for Tgat and Trio DH2, as indicated. The values and error bars are calculated from at least three independent experiments. Error bars represent standard deviation.

Figure 3: Specificity of the optimized inhibitory TRIP peptides

Comparison of TRIP^{E32G} and TRIP^{T16M/L17S} inhibition efficiency on different GTPase/RhoGEF systems, using 1 μ M GTPase and 0.5 μ M GEF: **A.** RhoA/Tgat ; **B.** RhoA/p63RhoGEF; **C.** RhoA/p115RhoGEF; **D.** RhoA/Lbc; **E.** RhoA/Dbl; **F.** RhoG/Trio DH1PH1. In each assay, the peptides were used at a concentration of 20 μ M, corresponding to a 40 fold molar excess of inhibitor versus GEF. All fluorescence kinetics assays were performed using 1 μ M mant-GTP. Results are expressed as Relative Fluorescence Units (RFU) versus time. The reaction performed in the absence of GEF reflects the spontaneous exchange activity of the GTPase.

Figure 4: TRIP^{E32G} inhibits Tgat GEF activity in cells

RhoA activation in NIH3T3-Tgat cells stably transfected with GFP, GFP-TRIP^{E32G} or GFP-TRIP^{T16M/L17S} was assayed by the GST-RBD-pulldown assay as described in Figure 1B. **A.** The levels of GTP-bound and total RhoA protein are shown in the upper two panels. Expression levels of all GFP-tagged proteins are shown in the lower panel. **B.** Quantification of the RhoA activity assay from at least three independent experiments. Error bars represent

standard deviation. **C.** Effect of GFP-TRIP^{E32G} on RhoA activation induced by Dbl (left panel) or Tgat (right panel) in NIH3T3 cells, assayed by GST-RBD pulldown. The levels of GTP-bound and total RhoA protein are shown in the upper two panels. Expression levels of Myc-Dbl and of all GFP-tagged proteins are shown in the lower two panels.

Figure 5: TRIP^{E32G} inhibits the transforming activity of Tgat *in vivo*.

A. Focus formation assay of NIH3T3 cells, stably expressing GFP or GFP-Tgat, together with GST or GST-TRIP^{E32G}. **B.** Quantification of three independent focus formation assays. The number of foci formed by Tgat/GST expressing cells was set to 100%. **C.** Tumor formation in Balb/c nude mice. NIH3T3 cells stably expressing GFP-Tgat/GST or GFP-Tgat/GST-TRIP^{E32G} were injected subcutaneously into the flanks of Balb/c nude mice and tumor volume was measured every week. The graph is representative of the three independent assays that were performed. **D.** Ten weeks post graft, mice were euthanised, tumors were excised and weighed, and the mean tumor weight was plotted on the graph. (*) A paired Student's t-test was performed, matching the samples for each mouse, and the P value was 0,019. Error bars represent standard deviation in all graphs.

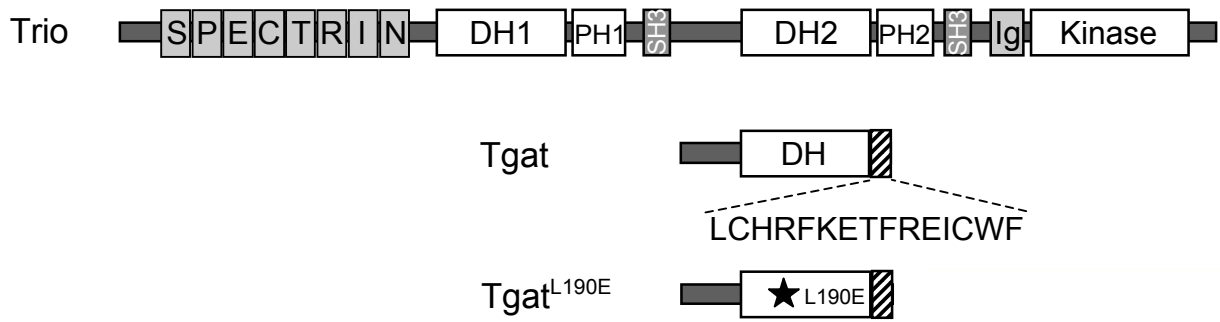
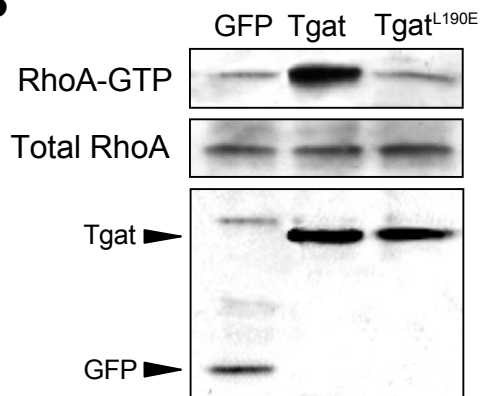
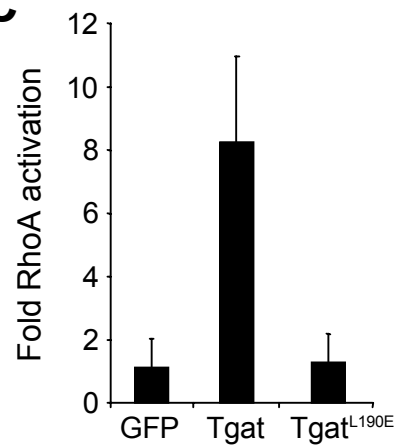
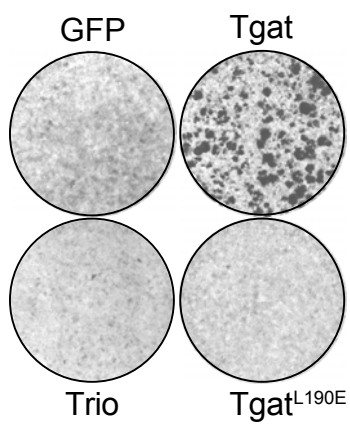
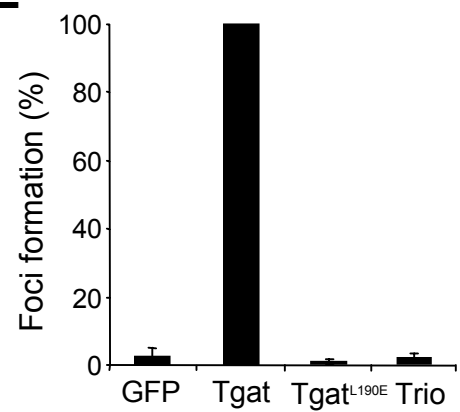
A**B****C****D****E**

Figure 1

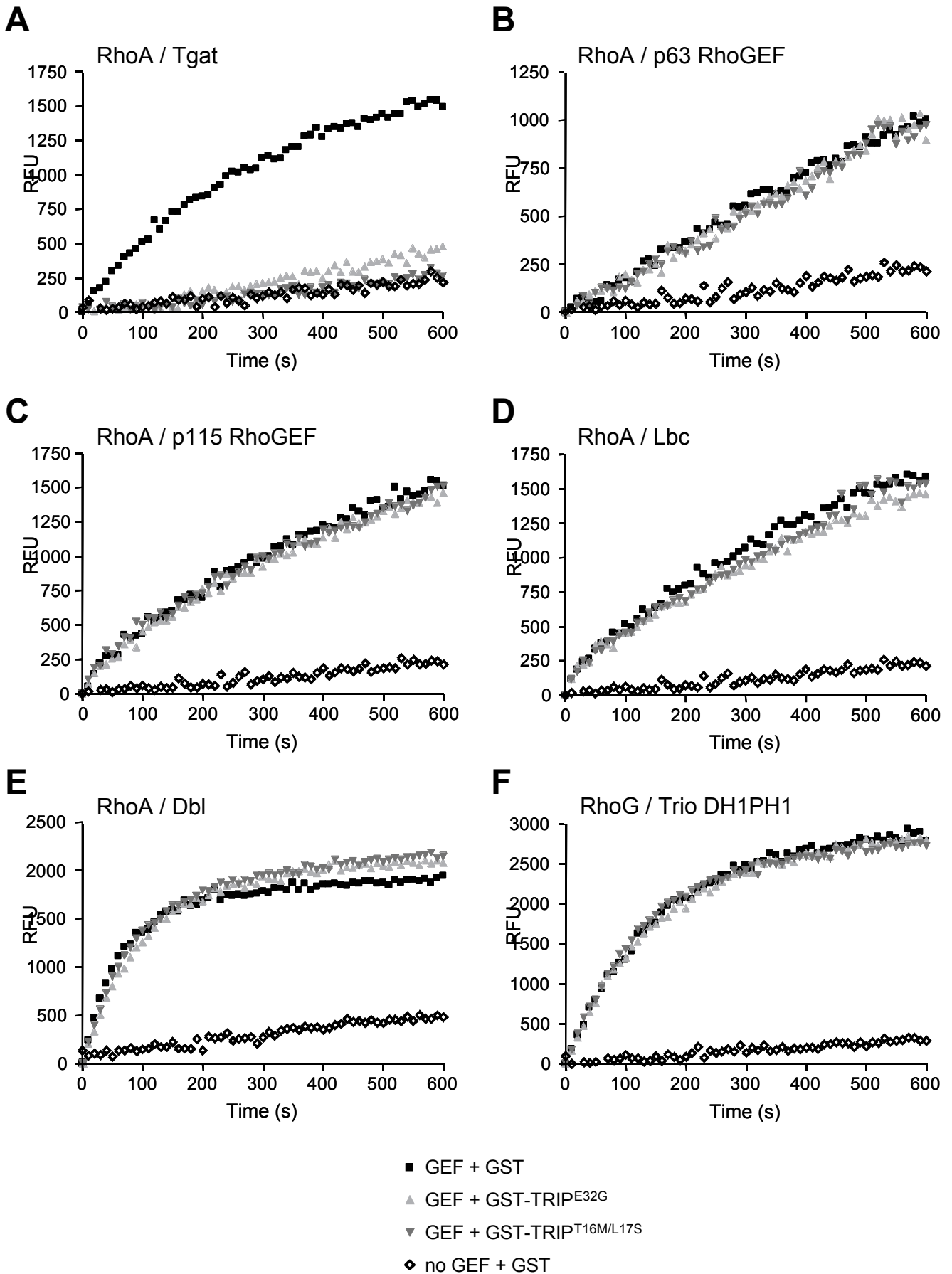


Figure 3

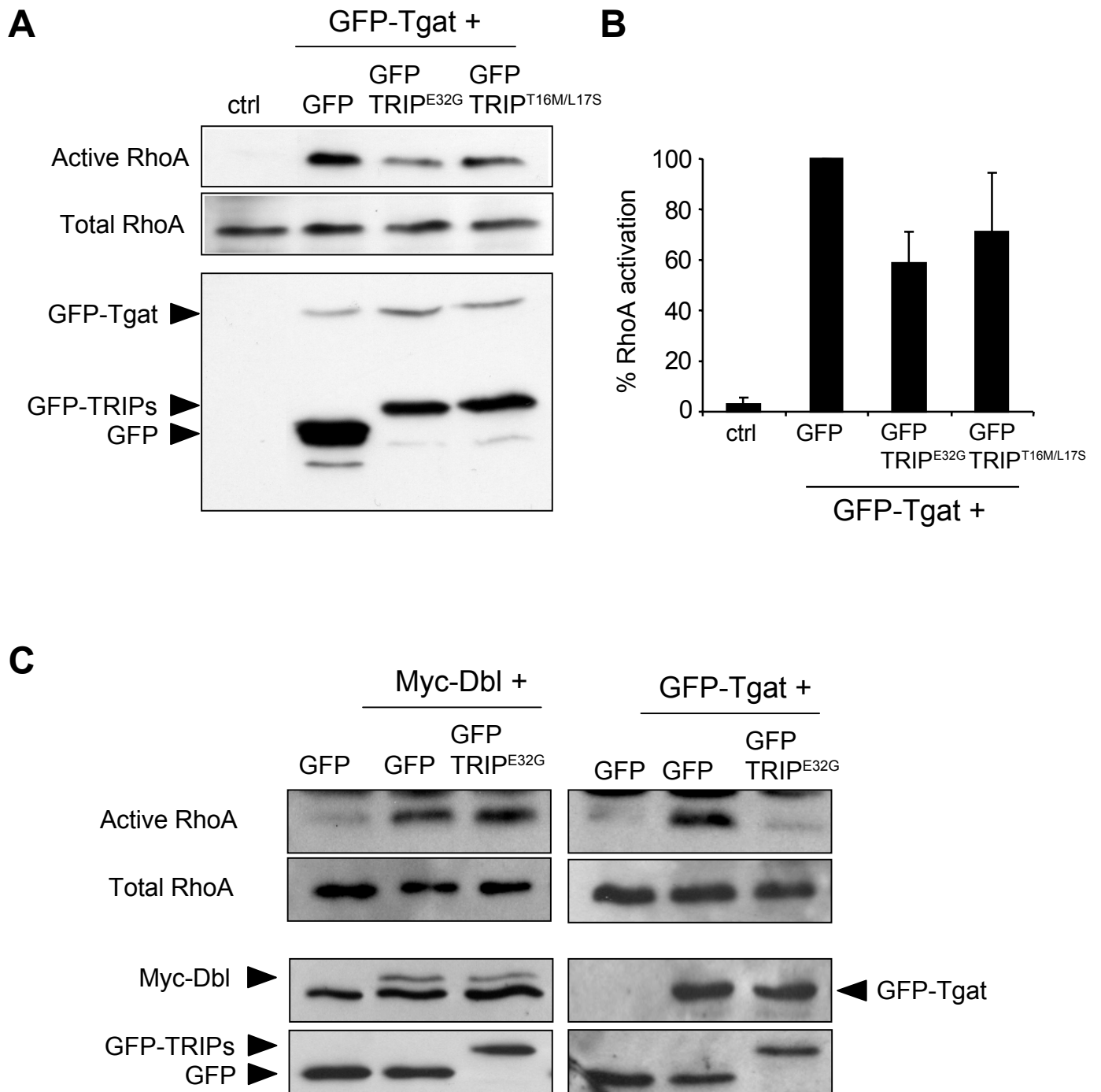


Figure 4

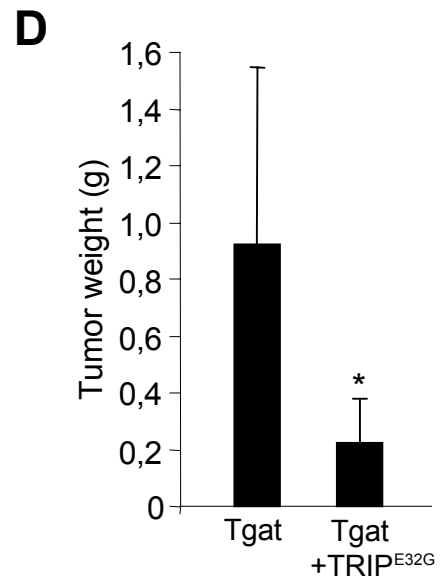
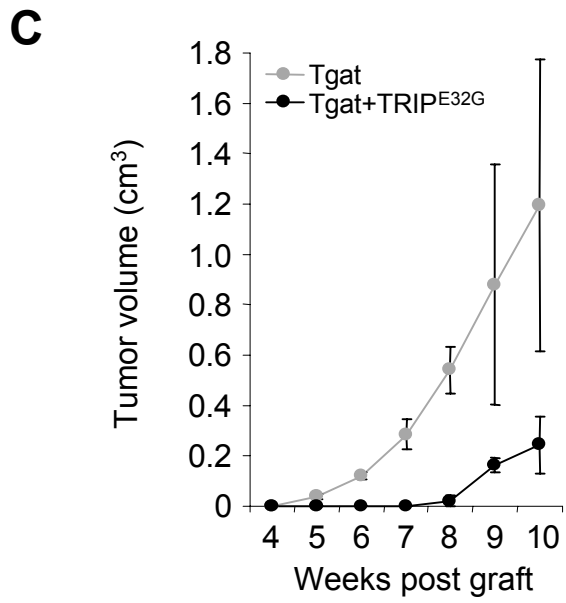
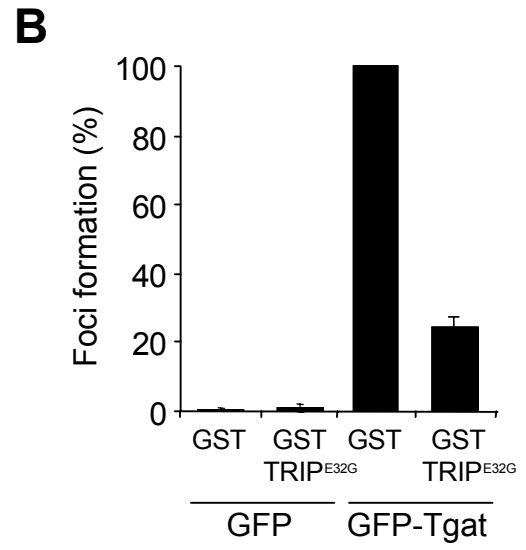
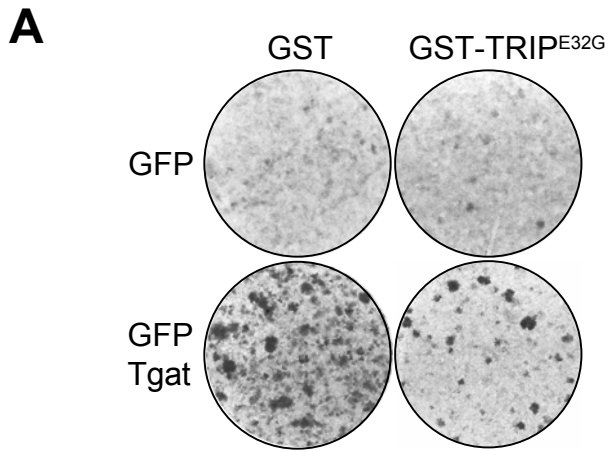


Figure 5