



HAL
open science

Locally Adaptive Resolution (LAR) codec

François Pasteau, Marie Babel, Olivier Déforgeries, Clément Strauss, Laurent Bédât

► **To cite this version:**

François Pasteau, Marie Babel, Olivier Déforgeries, Clément Strauss, Laurent Bédât. Locally Adaptive Resolution (LAR) codec. Ashraf A. Zaher. Recent Advances in Signal Processing, IN-TECH Education and Publishing, pp.37-48, 2009. hal-00392417

HAL Id: hal-00392417

<https://hal.science/hal-00392417>

Submitted on 8 Jun 2009

HAL is a multi-disciplinary open access archive for the deposit and dissemination of scientific research documents, whether they are published or not. The documents may come from teaching and research institutions in France or abroad, or from public or private research centers.

L'archive ouverte pluridisciplinaire **HAL**, est destinée au dépôt et à la diffusion de documents scientifiques de niveau recherche, publiés ou non, émanant des établissements d'enseignement et de recherche français ou étrangers, des laboratoires publics ou privés.

Chapter Number

Locally Adaptive Resolution (LAR) codec

François Pasteau, Marie Babel, Olivier Déforges,
Clément Strauss, Laurent Bédât
*IETR - INSA Rennes
France*

1. Introduction

Despite many drawbacks and limitations, JPEG is still the most commonly-used compression format in the world. JPEG2000 overcomes this old technique, particularly at low bit rates, but at the expense of a significant increase in complexity. A new compression format called JPEG XR has recently been developed with minimum complexity. However, it does not outperform JPEG 2000 in most cases (De Simone et al., 2007) and does not offer many new functionalities (Srinivasan et al., 2007). Therefore, the JPEG normalization group has recently proposed a call for proposals on JPEG-AIC (Advanced Image Coding) in order to look for new solutions for still image coding techniques (JPEG normalization group, 2007). Its requirements reflect the earlier ideas of Amir Said (Said & Pearlman, 1993) for a good image coder i.e. compression efficiency, scalability, good quality at low bit rates, flexibility and adaptability, rate and quality control, algorithm unicity (with/without losses), reduced complexity, error robustness (for instance in wireless transmission) and region of interest decoding at decoder level. Additional functionalities such as image processing at region level, both in the coder or the decoder, could be explored. One other important feature is complexity, in particular for embedded systems such as cameras or mobile phones, in which power consumption restriction is more critical nowadays than memory constraints. The reconfiguration ability of the coding sub-system can then be used to dynamically adapt the complexity to the current consumption and processing power of the system. In this context, we proposed the Locally Adaptive Resolution (LAR) codec as a contribution to the relative call for technologies, since it suited all previous functionalities. The related method is a coding solution that simultaneously proposes a relevant representation of the image. This property is exploited through various complementary coding schemes in order to design a highly scalable encoder.

The LAR method was initially introduced for lossy image coding. This efficient and original image compression solution relies on a content-based system driven by a specific quadtree representation, based on the assumption that an image can be represented as layers of basic information and local texture. Multiresolution versions of this codec have shown their efficiency, from low bit rates up to lossless compressed images. An original hierarchical self-extracting region representation has also been elaborated, with a segmentation process realized at both coder and decoder, leading to a free segmentation map. The map can then be further exploited for color region encoding or image handling at region level. Moreover,

the inherent structure of the LAR codec can be used for advanced functionalities such as content securization purposes. In particular, dedicated Unequal Error Protection systems have been produced and tested for transmission over the Internet or wireless channels. Hierarchical selective encryption techniques have been adapted to our coding scheme. A data hiding system based on the LAR multiresolution description allows efficient content protection. Thanks to the modularity of our coding scheme, complexity can be adjusted to address various embedded systems. For example, a basic version of the LAR coder has been implemented onto an FPGA platform while respecting real-time constraints. Pyramidal LAR solution and hierarchical segmentation processes have also been prototyped on heterogeneous DSP architectures.

Rather than providing a comprehensive overview that covers all technical aspects of the LAR codec design, this chapter focuses on a few representative features of its core coding technology. Firstly, profiles will be introduced. Then functionalities such as scalability, hierarchical region representation, adjustable profiles and complexity, lossy and lossless coding will be explained. Services such as cryptography, steganography, error resilience, hierarchical securized processes will be described. Finally application domains such as natural images, medical images and art images will be described.

An extension of the LAR codec is being developed with a view to video coding , but this chapter will not describe it and will stay focused on still image coding.

2. Design characteristics and profiles

The LAR codec tries to combine both efficient compression in a lossy or lossless context and advanced functionalities and services as described before. To provide a codec which is adaptable and flexible in terms of complexity and functionality, various tools have been developed. These tools are then combined in three profiles in order to address such flexibility features (Fig. 1).

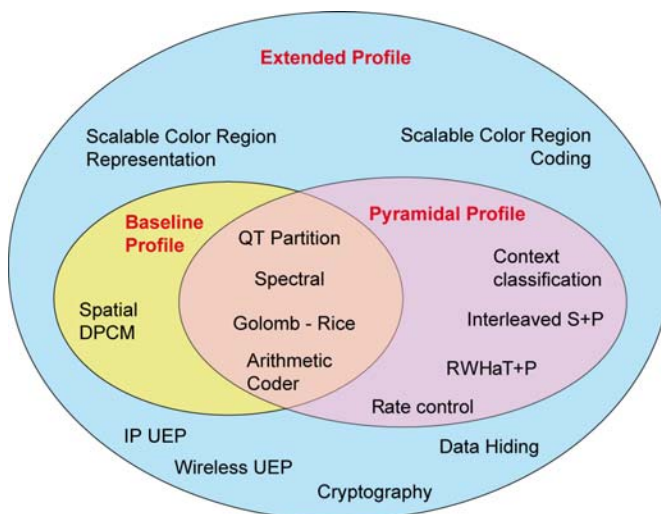

Fig. 1: Specific coding parts for LAR profiles

Therefore, each profile corresponds to different functionalities and different complexities:

- Baseline profile: low complexity, low functionality,
- Pyramidal profile: higher complexity but new functionalities such as scalability and rate control,
- Extended profile: higher complexity, but also includes scalable color region representation and coding, cryptography, data hiding, unequal error protection.

2. Technical features

2.1 Characteristics of the LAR encoding method

The LAR (Locally Adaptive Resolution) codec relies on a two-layer system (Fig. 2) (Déforges et al., 2007). The first layer, called Flat coder, leads to the construction of a low bit-rate version of the image with good visual properties. The second layer deals with the texture. It is encoded through a texture coder, to achieve visual quality enhancement at medium/high bit-rates. Therefore, the method offers a natural basic SNR scalability.

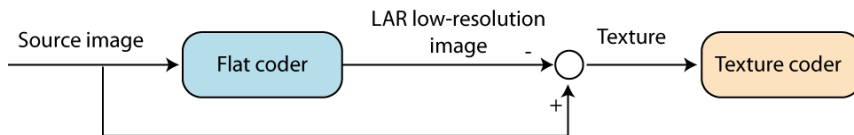

Fig. 2 : General scheme of a two-layer LAR coder

The basic idea is that local resolution, in other words pixel size, can depend on local activity, estimated through a local morphological gradient. This image decomposition into two sets of data is thus performed in accordance with a specific quadtree data structure encoded in the Flat coding stage. Thanks to this type of block decomposition, their size implicitly gives the nature of the given block i.e. the smallest blocks are located at the edges whereas large blocks map homogeneous areas. Then, the main feature of the FLAT coder consists of preserving contours while smoothing homogeneous parts of the image (Fig. 3).

This quadtree partition is the key system of the LAR codec. Consequently, this coding part is required whatever the chosen profile.



Fig. 3 : Flat coding of "Lena" picture without post processing

2.2 Baseline Profile

The baseline profile is dedicated to low bit-rate encoding (Déforges et al., 2007). As previously mentioned, the quadtree partition builds a variable block size representation of the image and the LAR low-resolution image is obtained when filling each block by its mean luminance value. Moreover, in a lossy context, this semantic information controls a quantization of the luminance. Large blocks require fine quantization (in uniform areas, human vision is highly sensitive to brightness variations) while coarse quantization (low sensitivity) is sufficient for small blocks. Block values are encoded through a DPCM scheme, adapted to our block representation.

The flat LAR coder is clearly dedicated to low bit-rate image coding. To obtain higher image quality, the texture (whole error image) can be encoded through the spectral coder (second layer of the LAR coding scheme) which uses a DCT adaptive block size approach. In this case, both the size and the DC components are provided by the flat coder. The use of adapted block size naturally allows for a semantic scalable encoding process. For example, edge enhancement can be achieved by only transmitting the AC coefficients of small blocks. Further refinements can be envisaged by progressively sending larger block information.

With regard to the entropy coder, we simply adapted the classical Golomb-Rice coder for low complex applications, and the arithmetic coder for better compression results.

2.3 Pyramidal Profile

To both increase scalability capacity and address lossless compression, we have proposed multiresolution extensions of the basic LAR called Interleaved S+P (Babel et al., 2005) and RWHaT+P (Déforges et al., 2005). The overall approach used in these two techniques is identical; the only difference lies in the decomposition step. To fit the Quadtree partition, dyadic decomposition is carried out. The first and second layers of the basic LAR are replaced by two successive pyramidal decomposition processes. However the image representation content is preserved. The first decomposition reconstructs the low-resolution image (block image) while the second one processes local texture information (Fig. 2). These methods provide both increasing scalability and an efficient lossy to lossless compression solution.

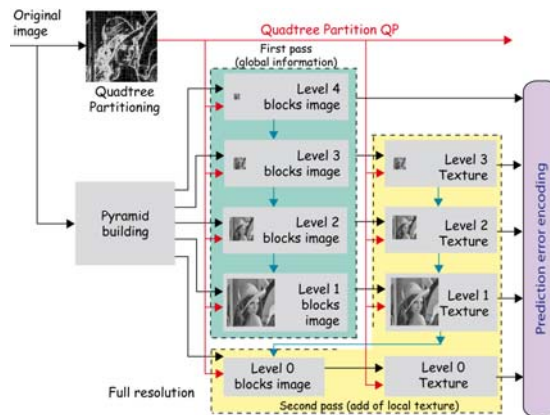

Fig. 4: LAR pyramidal decomposition

In the pyramidal profile, we use mainly the arithmetic coding scheme for prediction error encoding. The original structure of the LAR codec automatically produces context modelling, reducing zeroth order entropy cost. By adding specific inter-classification methods, the compression efficiency can be greatly increased (Pasteau et al., 2008); (Déforges et al., 2008).

2.4 Hierarchical region representation and coding - Extended Profile

For color images, we have designed an original hierarchical region-based representation technique adapted to the LAR coding method. An initial solution has already been proposed in (Déforges et al., 2007). To avoid the prohibitive cost of region shape descriptions, the most suitable solution consists of performing the segmentation directly, in both the coder and decoder, using only a low bit-rate compressed image resulting from the flat coder (or first partial pyramidal decomposition). Natural extensions of this particular process have also made it possible to address medium and high quality encoding and the region-level encoding of chromatic images. Another direct application for self-extracting region representation is found in a coding scheme with local enhancement in Regions Of Interest (ROI). Current work is aimed at providing a fully multiresolution version of our segmentation process. Indeed, this region representation can be connected to the pyramidal decomposition in order to build a highly scalable compression solution.

The extended profile also proposes the use of dedicated steganography and cryptography processes, which will be presented in the next sections.

To sum up, the interoperability of coding and representation operations leads to an interactive coding tool. The main features of the LAR coding parts are depicted on Fig. 5.

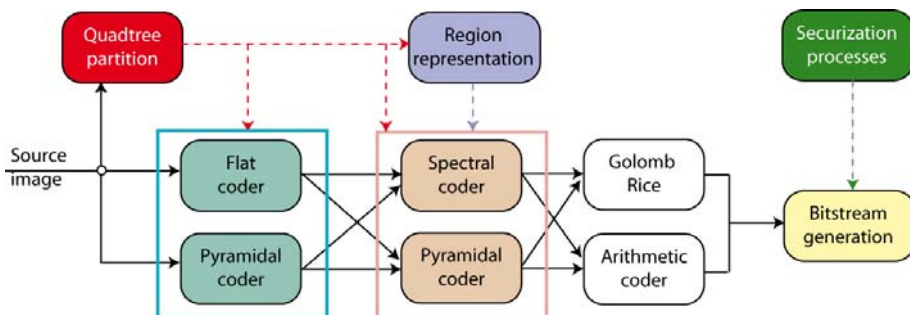

Fig. 5: Block diagram of extended profile of the LAR coder

3. Functionalities

3.1 Scalable lossy to lossless compression

The pyramidal description of the images resulting from Interleaved S+P or RWHaT+P encoding provides various scalability levels. The conditional decomposition (the constraint of two successive descent processes by the initial quadtree partition of the image) provides a highly scalable representation in terms of both resolution and quality.

This scalable solution allows compression from lossy up to lossless configuration. The pyramidal profile codec has been tested and has shown its efficiency on natural images as

depicted on Fig. 6 and Table 1, as well as medical images (Babel et al., 2008) and high resolution art images (Babel et al., 2007).

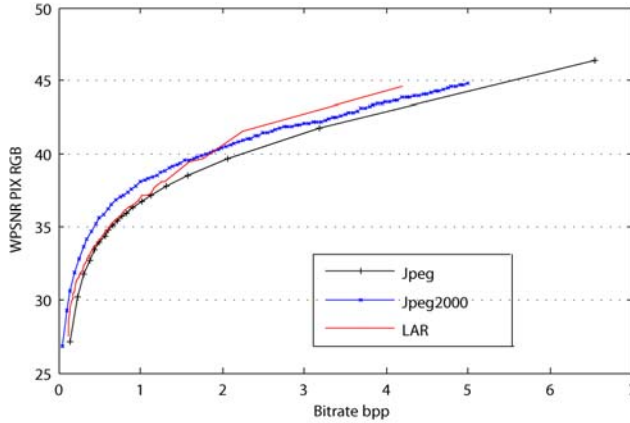

Fig. 6: Objective comparisons of Jpeg, Jpeg2000 and LAR Interleaved S+P codec for WPSNR PIX RGB metric (De Simone et al., 2008) on the lena image

Image	RGB	YDbDr	JPEG 2000
Lena	13.21 bpp	13.22 bpp	13.67 bpp
Mandrill	17.98 bpp	17.99 bpp	18.18 bpp
Pimento	14.60 bpp	14.87 bpp	14.92 bpp
Fruit	10.42 bpp	10.46 bpp	9.58 bpp

Table 1: JPEG 2000 / LAR coder comparison of color lossless compression of natural images with different color spaces.

3.2 Region level handling

Through the definition of a Region of Interest (ROI), images can be lossily compressed overall and losslessly encoded locally as shown on Fig. 7. Combined with a progressive encoding scheme, region scalability allows faster access to significant data. The LAR scheme enables more flexible solutions in terms of ROI shape and size. Indeed, an ROI can be simply described at both the coder and decoder as a set of blocks resulting from the quadtree partition. As the ROI is built from the variable block size representation, its enhancement (texture coding) is straightforward - it merely requires execution of the Interleaved S+P or RWHaT codec for the validated blocks, i.e. ROI internal blocks. Unlike traditional compression techniques, the LAR low resolution image does not introduce strong distortions on the ROI contours. Such distortion usually makes the image too unreliable to be used (Babel et al., 2007); (Babel et al., 2003).

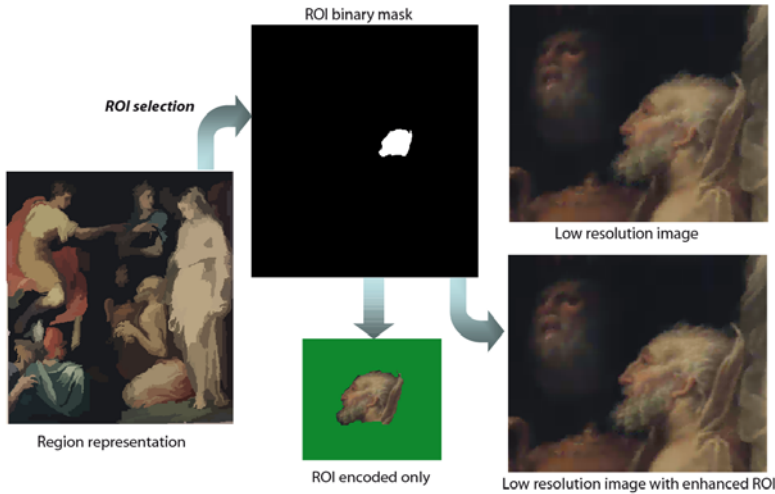

Fig. 7: ROI enhancement scheme of LAR codec

3.3 Adjustable complexity

The modularity of our scheme produces a new level of scalability in terms of complexity, closely related to the chosen profile. The IETR laboratory also aims to provide automatic solutions of fast prototyping onto heterogeneous architecture (DSPs, FPGAs), using Algorithm Architecture Matching methodology. Consequently, although the LAR codec has been developed on PCs, we can easily implement various LAR versions on embedded systems.

Previous work focused on fast development and the implementation of the distributed LAR image compression framework on multi-components for flat LAR (Raulet et al., 2003), or for extended profiles with the proper region description, using cosimulation approaches (Flécher et al., 2007). For these embedded versions, we used the Golomb-Rice coder as the entropy coder, because of its lower complexity.

We presented in (Déforges & Babel, 2008) a dedicated FPGA implementation of the FLAT LAR image coder. This coding technique is particularly suitable for low bit-rate compressions. From an image quality point of view, the FLAT LAR presents better results than JPEG, while implementation resources requirements are similar. Internal architecture has been designed as a set of parallel and pipelined stages, enabling full image processing during a single regular scan. The architecture latency is extremely low as it is determined by the data acquisition for one slice of 8 lines.

4. Services

4.1 Error resilience

Protecting the encoded bit-stream against error transmission is required when using networks with no guaranteed quality of service (QoS). In particular, the availability of the information can be ensured by the Internet protocol (IP). We focused our studies on two topics, namely the loss of entire IP packets and transmission over wireless channels.

Limited bandwidth and distortions are the main features of a wireless channel. Therefore, both compression and secured transmission of sensitive data are simultaneously required. The pyramidal version of the LAR method and an Unequal Error Protection strategy are applied respectively to compress and protect the original image. The UEP strategy takes account of the sensitivity of the substreams requiring protection then optimizes the redundancy rate. In our application, we used the Reed Solomon Error Correcting Code RS-ECC, combined with symbol block interleaving for simulated transmission over the COST27 TU channel (W. Hamidouche et al., 2009). When comparing this to the JPWL system, we show that the proposed layout is better than the JPWL system, especially when transmission conditions are poor (SNR<21 dB).

With regard to the other topic, compensating IP packet loss also requires an UEP process. This is done by using an exact and discrete Radon transform, the Mojette transform (Babel et al., 2008). The frame-like definition of this transform allows redundancies that can be further used for image description and image communication (Fig. 8), for QoS purposes.

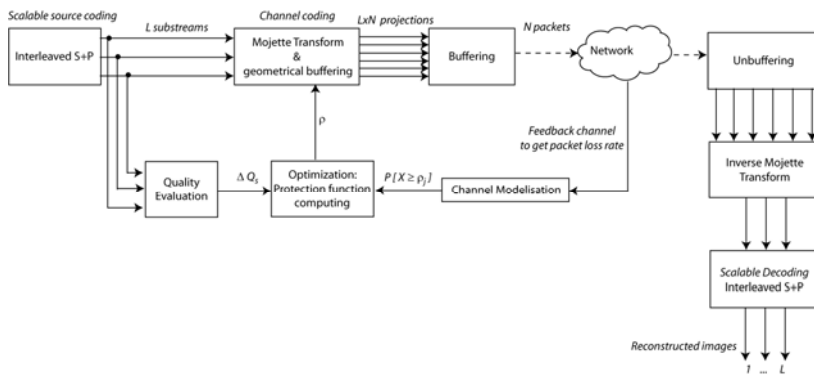

Fig. 8: General joint LAR-Mojette coding scheme

4.2 Content securization: cryptography and steganography

Besides watermarking, steganography, and techniques for assessing data integrity and authenticity, providing confidentiality and privacy for visual data is one of the most important topics in the area of multimedia security. Our research focuses on fast encryption procedures specifically tailored to the target environment. For that purpose, we use the pyramidal profile with Interleaved S+P configuration.

As the representation relies entirely on knowledge of the quadtree partition, this partition needs to be transmitted without any error. Previous work on error resilience dealt with that aspect and has shown that the decoder was still able to decode erroneous bit-streams. In that case, visual quality was very poor as depicted on Fig. 10, even when only a few bits of the quadtree were wrongly transmitted. Consequently, we propose to encrypt different levels of the quadtree partition description, as depicted on Fig. 9 (Fonteneau et al., 2008). This scheme is equivalent to a selective encryption process. Indeed, the encryption of a given level of the partition prevents the recovery of any additional visually-significant data. From a distortion point of view, it appears that encrypting higher levels (smaller blocks) increases the PSNR, and at the same time, the encrypting cost. From a security point of view, as the level increases, so the search space for a brute force attack increases drastically.

Moreover, we propose a method based on using the quadtree decomposition as a way to protect the content of the image. The main idea is to transmit the data without quadtree decomposition, using the quadtree as the key to decrypt the image (Motsch et al., 2006). This system has the following properties: embedded in the original bit-stream at no cost, allowing multilevel access authorization combined with state-of-the-art still picture codec. Multilevel quadtree decomposition provides a way to select the quality of the picture decoded.

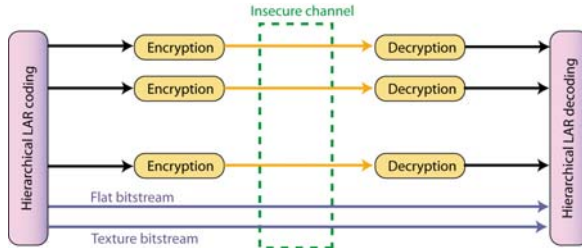

Fig. 9: LAR hierarchical selective encryption principle

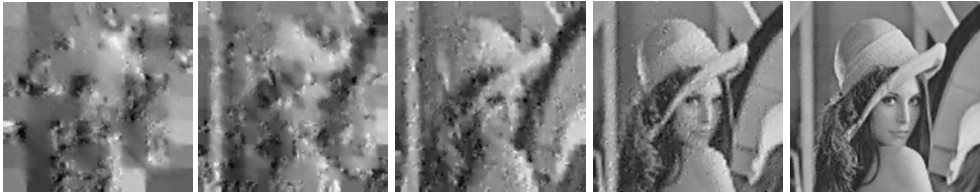

Fig. 10: RC4 encryption of partition from highest level to full resolution of the lena image

For the steganography point of view, we have adapted a fast and efficient reversible data embedding algorithm for the LAR-Interleaved S+P compression framework, namely the Difference Expansion, as the two techniques are based on the S-transform. Both this codec and the data embedding algorithm explore the redundancy in the digital picture to achieve either better than state-of-the-art compression rates or reversible data embedding respectively. The resultant capacity-distortion rates for embedded images were among the best in the literature on lossless data embedding (Motsch et al., 2009),(Fig. 11).



a) Original image b) Data embedded image

Fig. 11: Data embedding of 100,000 bits in the lena image

4.3 Client-server application and hierarchical access policy

In France, the C2RMF laboratory connected to the Louvre museum has digitized more than 300,000 documents taken from French museums, in high resolution (up to 20000×30000 pixels). The resulting EROS database is, for the moment, only accessible to researchers whose work is connected with the C2RMF. The TSAR project (Secure Transmission of high-Resolution Art images) is supported by the French National Research Agency. The idea is to integrate another scalable coding solution able to achieve a high lossy and lossless compression ratio. A second area of research concerns the secure access of images. The objective is to design an art image database accessible through a client-server process that includes and combines a hierarchical description of images and a hierarchical secured access.

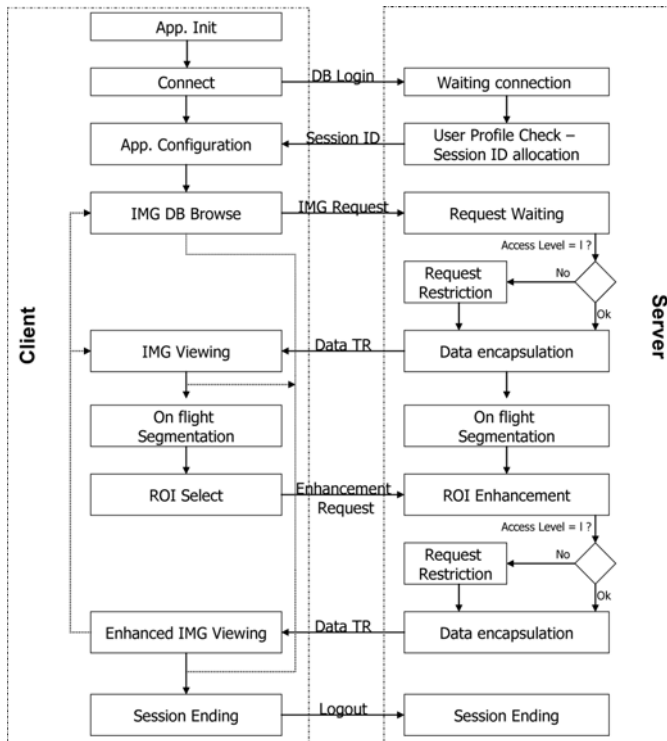

Fig. 12: Exchange protocol for client-server application

We are currently working on a corresponding client-server application (Babel et al., 2007). Every client will be authorized to browse the low-resolution image database and the server application will verify the user access level for each image and ROI request. If a client application sends a request that does not match the user access level, the server application will reduce the image resolution according to access policy. The exchange protocol is depicted in Fig. 12.

5. Conclusion

In this chapter, we focused on a few representative features of the LAR coding technology and its preliminary associated performances. This algorithm fulfills different functionalities and services, such as scalability, region-level handling, steganography, cryptography, robustness and adjustable complexity. These functionalities have yet to be evaluated with ad-hoc tools that have to be defined in the JPEG-AIC context. Furthermore, some of the results presented have revealed better than state-of-the-art performances.

As the LAR coder provides good results in terms of both compression, representation and functionalities, an extension of the LAR codec aimed at video compression with associated services is being worked on.

6. References

- Babel, M.; Déforges, O. & Ronsin, J. (2003). Adaptive Multiresolution Scheme for Efficient Image Compression, *Proceedings of Picture Coding Symposium*, April, 2003, pp. 23-25.
- Babel, M.; Déforges, O. & Ronsin, J. (2005). Interleaved S+P pyramidal decomposition with refined prediction model, *Proceedings of Image Processing, ICIP 2005, IEEE International Conference on*, pp. II-750-3, 0-7803-9134-9, Genova Swiss, September 2005, Genova.
- Babel, M.; Déforges, O.; Bédard, L. & Motsch, J. (2007). Context-Based Scalable Coding and Representation of High Resolution Art Pictures for Remote Data Access, *Multimedia and Expo, 2007 IEEE International Conference on*, 2007, pp. 460-463.
- Babel, M.; Parrein, B.; Déforges, O.; Normand, N.; Guédon, J. & Coat V. (2008). Joint source-channel coding: Secured and progressive transmission of compressed medical images on the Internet, In: *Computerized Medical Imaging and Graphics*, vol. 32, June, 2008, pp. 258-269.
- Déforges, O.; Babel, M. & Motsch, J. (2006). The RWHT+P for an improved lossless multiresolution coding, *proceedings of EUSIPCO 2006*, August 2006, p. nc , Florence Italy
- Déforges, O.; Babel, M.; Bédard, L. & Ronsin, J. (2007). Color LAR Codec: A Color Image Representation and Compression Scheme Based on Local Resolution Adjustment and Self-Extracting Region Representation, *Circuits and Systems for Video Technology* , *IEEE Transactions on*, Vol. 17, Issue. 8, August 2007, 974-987, 1051-8215
- Déforges, O.; Babel, M.; Bédard, L. & Coat, V. (2008). Scalable lossless and lossy image coding based on the RWHaT+P pyramid and the inter-coefficient classification method, *Proceedings of Multimedia and Expo, 2008 IEEE International Conference on*, pp. 185-188, 978-1-4244-2570-9, Hanover Germany, June 2008, Hanover.
- Déforges O. & Babel M. (2008). LAR method: from algorithm to synthesis for an embedded low complexity image coder, *3rd International Design and Test Workshop 3rd International Design and Test Workshop, IDT'08* , Monastir Tunisia : 2008, pp. 1-4 .
- De Simone, F.; Ticca, D.; Dufaux, F.; Ansorge, M.; Ebrahimi, T. (2008). A comparative study of color image compression standards using perceptually driven quality metrics, *Proceedings of SPIE 2008*, vol. 7073, San Diego, CA USA, August 11-14, 2008.

- De Simone, F.; Ouaret, M.; Dufaux, F.; Tescher, A. G. and Ebrahimi, T. (2007). A comparative study of JPEG 2000, AVC/H264, and HD Photo, *Proceedings of SPIE 2007*, San Diego, vol. 6696, August 2007
- Flécher, E.; Raulet, M.; Roquier, G.; Babel, M. & Déforges, O. (2007). Framework For Efficient Cosimulation And Fast Prototyping on Multi-Components With AAA Methodology: LAR Codec Study Case, *Proceedings of 15th European Signal Processing Conference (Eusipco 2007)*, Poznan; Poland : 2007, pp. ISBN: 978-83-921340-2-2 .
- Fonteneau, C.; Motsch, J.; Babel, M. & Déforges, O. (2008). A Hierarchical Selective Encryption Technique in a Scalable Image Codec, *Proceedings of International Conference in Communications International Conference in Communications* , Bucharest Romania : 2008, pp. 1-4 .
- Hamidouche, W.; Olivier, C.; Babel, M.; Deforges, O.; Boeglen, H. and Lorenz, P (2009). LAR Image Transmission over Fading Channels: a Hierarchical Protection Solution, in *2nd Int. Conf. on Communication Theory, Reliability and Quality of Service*, IEEE Xplore, Colmar (France), July 2009.
- JPEG normalization group (2007). Jpeg-aic: scope and evaluation. *International Standards Organization working document*, ISO/IEC SC29/WG 1/N4326, 2007
- Motsch, J.; Déforges, O. & Babel, M. (2006). Embedding Multilevel Image Encryption in the LAR Codec, *Proceedings of IEEE Communications International Conference* , 2006, p. 4
- Motsch, J.; Déforges, O. & Babel, M. (2009). Joint lossless coding and reversible data embedding in a multiresolution still image coder, *Proceedings of the EUSIPCO'09 European Signal Processing Conference*, pp. 1-5, EUSIPCO , Glasgow Scotland, August 2009
- Pasteau, F.; Babel, M.; Déforges, O. & Bédard, L. (2008). Interleaved S+P Scalable Coding with Inter-Coefficient Classification Methods, *Proceedings of the EUSIPCO'08 European Signal Processing Conference*, pp. 1-5, EUSIPCO , Lausanne Swiss, August 2008
- Raulet, M.; Babel, M.; Déforges, O.; Nezan, J. & Sorel, Y. (2003). Automatic coarse-grain partitioning and automatic code generation for heterogeneous architectures, *Signal Processing Systems, SIPS 2003. IEEE Workshop on*, 2003, pp. 316-321.
- Said, A. and Pearlman, W. (1993). Reversible image compression via multiresolution representation and predictive coding. In *Visual Communication and Image Processing*, volume 209, pages 664-674. SPIE, Novembre 1993
- Srinivasan, S.; Tu, C.; Zhou, Z.; Ray, D.; Regunathan, S. and Sullivan, G. (2007). *An Introduction to the HD Photo Technical Design*, Microsoft Corporation WG 1/N4183, 2007